



Built-in Double Oven

User Manual



**BBADF22300X-BBDF22300B-BBDF26300X
BBXDF29300Z-BBNDF22300XD-BBXDF22300S
BBXDF25300X-CDFY22309X**

EN

385.4405.21/R.AB/10.05.2021

7731686338-7731686388-7731686389-7731686390-7731686395-7731686399-7731686400-7756886396

Please read these instructions first before using your appliance

Thank you for choosing a Beko appliance.

Please take some time to read this user manual before using your appliance, to ensure you know how to safely operate the controls and functions.

Carefully follow all unpacking and installation instructions to ensure the appliance is correctly connected and fitted prior to use.

Please write your product model and serial number on the last page of this user manual, and store in a safe location close to the appliance for easy future reference.

This user manual may also be applicable for several other models. Differences between models will be listed.

If you have any questions or concerns, please call our contact centre or find help and information online at www.beko.co.uk

Explanation of symbols used throughout this User Manual



Important information or useful hints about usage.



Warning of hazardous situations with regard to life and property.



Warning of electric shock.



Warning of risk of fire.



Warning of hot surfaces.



This product was manufactured using the latest technology in environmentally friendly conditions.

TABLE OF CONTENTS

1 Important instructions and warnings for safety and environment 4

General safety	4
Electrical safety	5
Product safety.....	6
Intended use.....	8
Safety for children	8
Disposing of the old product	9
Package information.....	9

2 General information 10

Overview	10
Package contents	11
Technical specifications	12

3 Installation 13

Before installation.....	13
Installation and connection.....	14
Future Transportation	16

4 Preparation 17

Tips for saving energy.....	17
Initial use	17
Time setting.....	17
First cleaning of the appliance	18
Initial heating	18

5 How to operate the oven 19

General information on baking, roasting and grilling.....	19
How to operate the electric oven	20
Operating modes.....	21
Using the oven clock.....	22
Settings	24
Cooking times table	26
How to operate the top oven.....	29
Cooking times table	29
How to operate the top grill.....	31
Top oven cooking times table for grilling	31

6 Maintenance and care 32

General cleaning information	32
Cleaning the accessories	33
Cleaning the control panel.....	33
Cleaning the inside of the oven (cooking area)	33
Cleaning the oven door	35
Removing the door inner glass	35
Cleaning the oven lamp.....	36

7 Troubleshooting 38

8 Guarantee Details 39

1 Important instructions and warnings for safety and environment

This section contains safety instructions that will help protect from risk of personal injury or property damage. Failure to follow these instructions shall void any warranty.

General safety

- This appliance can be used by children aged from 8 years and above and persons with reduced physical, sensory or mental capabilities or lack of experience and knowledge if they have been given supervision or instruction concerning use of the appliance in a safe way and understand the hazards involved.
Children shall not play with the appliance. Cleaning and user maintenance shall not be made by children without supervision.
- The appliance is not to be used by persons (including children) with reduced physical, sensory or mental capabilities, or lack of experience and knowledge, unless they have been given supervision or instruction. Children should be supervised and ensure they do not play with the appliance
- If the product is handed over to someone else for personal use or second-hand use purposes, the user manual, product labels and other relevant documents and parts should be also given.
- Installation and repair procedures must always be performed by Authorised Service Agents. The manufacturer shall not be held responsible for damages arising from procedures carried out by unauthorised persons which may also void the warranty. Before installation, read the instructions carefully.
- Do not operate the product if it is defective or has any visible damage.
- Ensure that the product function knobs are switched off after every use.

Electrical safety

- If the product has a failure, it should not be operated unless it is repaired by an Authorised Service Agent. There is the risk of electric shock!
- Only connect the product to a grounded outlet/line with the voltage and protection as specified in the “Technical specifications”. Have the grounding installation made by a qualified electrician while using the product with or without a transformer. Our company shall not be liable for any problems arising due to the product not being earthed in accordance with the local regulations.
- Never wash the product by spreading or pouring water onto it! There is the risk of electric shock!
- The product must be disconnected during installation, maintenance, cleaning and repairing procedures.
- If the power connection cable for the product is damaged, it must be replaced by the manufacturer, its service agent or similarly qualified persons in order to avoid a hazard.
- Only use the connection cable specified in the “Technical specifications”.
- The appliance must be installed so that it can be completely disconnected from the mains supply. The separation must be provided by a switch built into the fixed electrical installation, according to construction regulations.
- Rear surface of the oven gets hot when it is in use. Make sure that the electrical connection does not contact with the rear surface; otherwise, connections can get damaged.
- Do not trap the mains cable between the oven door and frame and do not route it over hot surfaces. Otherwise, cable insulation may melt and cause fire as a result of short circuit.
- Any work on electrical equipment and systems should only be carried out by authorised and qualified persons.
- In case of any damage, switch off the product and

disconnect it from the mains. To do this, turn off the fuse at home.

- Make sure that fuse rating is compatible with the product.

Product safety

- **WARNING:** The appliance and its accessible parts become hot during use. Care should be taken to avoid touching heating elements. Children less than 8 years of age shall be kept away unless continuously supervised.
- Never use the product when your judgment or coordination is impaired by the use of alcohol and/or drugs.
- Be careful when using alcoholic drinks in your dishes. Alcohol evaporates at high temperatures and may cause fire since it can ignite when it comes into contact with hot surfaces.
- Food Poisoning Hazard: Do not let food sit in oven for more than 1 hour before or after cooking. Doing so can result in food poisoning or sickness.
- Do not place any flammable materials close to the product as the sides may become hot during use.
- During use the appliances becomes hot. Care should be taken to avoid touching heating elements inside the oven.
- Keep all ventilation slots clear of obstructions.
- Do not heat closed tins and glass jars in the oven. The pressure that would build-up in the tin/jar may cause it to burst.
- Do not place baking trays, dishes or aluminium foil directly onto the bottom of the oven. The heat accumulation might damage the bottom of the oven.
- Do not use harsh abrasive cleaners or sharp metal scrapers to clean the oven door glass since they can scratch the surface, which may result in shattering of the glass.
- Do not use steam cleaners to clean the appliance as this may cause an electric shock.
- (Varies depending on the product model.)

Placing the wire shelf and tray onto the wire racks properly

It is important to place the wire shelf and/or tray onto the rack properly. Slide the wire shelf or tray between 2 rails and make sure that it is balanced before placing food on it (Please see the following figure).

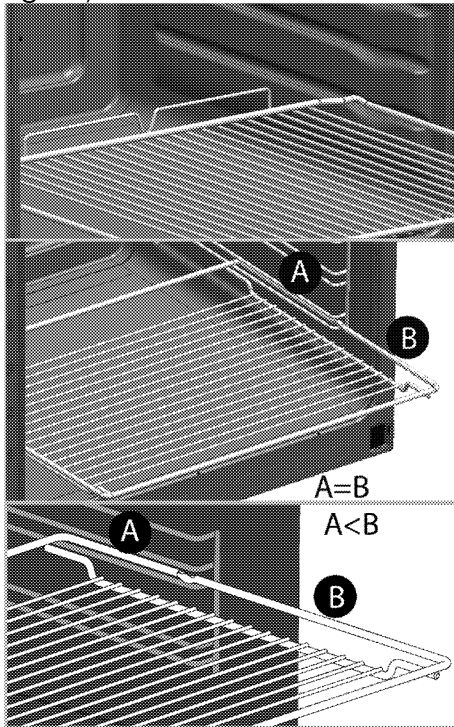

- Do not use the product if the front door glass is removed or cracked.
- Always use heat resistant oven gloves when putting in

or removing dishes into/from the hot oven.

- Place the baking paper into the cooking pot or on to the oven accessory (tray, wire grill etc) together with the food and then insert all into the preheated oven. Remove the excess parts of the baking paper overflowing from the accessory or the pot in order to prevent the risk of touching the oven's heating elements. Never use the baking paper in an operating temperature higher than the indicated value for the baking paper. Do not place the baking paper directly on the base of the oven.
- **WARNING:** Ensure that power cord of the appliance is unplugged or circuit breaker is switched off before replacing the lamp to avoid the possibility of electric shock.
- The appliance must not be installed behind a decorative door in order to avoid overheating.

Prevention against possible fire risk!

- Ensure all electrical connections are secure and tight to prevent risk of arcing.
- Do not use damaged cables or extension cables.
- Ensure liquid or moisture is not accessible to the electrical connection point.

Intended use

- This product is designed for domestic use. Commercial use will void the guarantee.
- **CAUTION:** This appliance is for cooking purposes only. It must not be used for other purposes, for example room heating.
- This product should not be used for warming the plates under the grill, drying towels, dish cloths etc. by hanging them on the oven door handles. This product should also not be used for room heating purposes.
- The manufacturer shall not be liable for any damage caused by improper use or handling errors.
- The oven can be used for defrosting, baking, roasting and grilling food.

Safety for children

- **WARNING:** Accessible parts may become hot during use. Young children should be kept away.
- The packaging materials will be dangerous for children. Keep the packaging materials away from children. Please dispose of all parts of the packaging according to environmental standards.
- Electrical products are dangerous to children. Keep children away from the product when it is operating and do not allow them to play with the product.
- Do not place any items above the appliance that children may reach for.
- When the door is open, do not load any heavy object on it and do not allow children to sit on it. It may overturn or door hinges may get damaged.

Disposing of the old product

Compliance with the WEEE Directive and Disposing of the Waste Product:



This product complies with EU WEEE Directive (2012/19/EU). This product bears a classification symbol for waste electrical and electronic equipment (WEEE).

This product has been manufactured with high quality parts and materials which can be reused and are suitable for recycling. Do not dispose of the waste product with normal domestic and other wastes at the end of its service life. Take it to the collection center for the recycling of electrical and electronic

equipment. Please consult your local authorities to learn about these collection centers.

Compliance with RoHS Directive:

The product you have purchased complies with EU RoHS Directive (2011/65/EU). It does not contain harmful and prohibited materials specified in the Directive.

Package information

- Packaging materials of the product are manufactured from recyclable materials in accordance with our National Environment Regulations. Do not dispose of the packaging materials together with the domestic or other wastes. Take them to the packaging material collection points designated by the local authorities.

2 General information

Overview

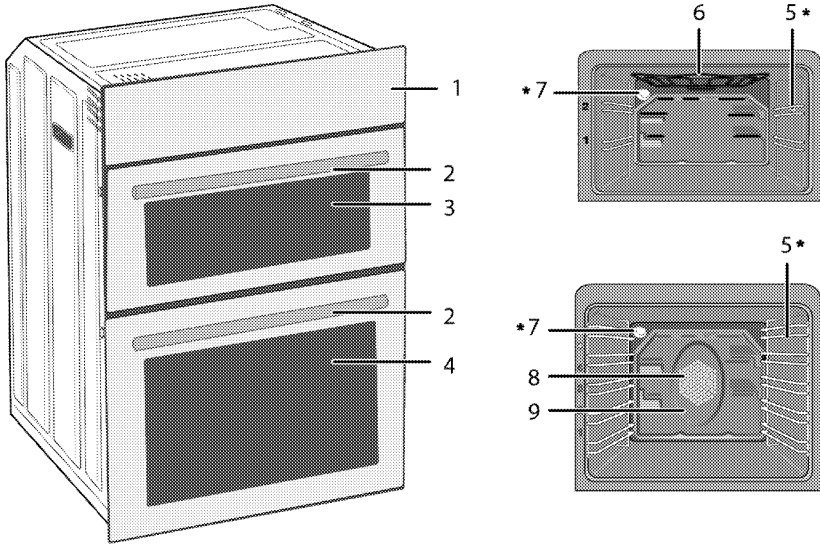

- | | |
|-------------------------|---|
| 1 Control panel | 7 Lamp* |
| 2 Handle | 8 Fan motor (behind steel plate) |
| 3 Top oven | 9 Ring heater |
| 4 Main oven | * (This feature is optional. It may not exist on your product.) |
| 5 Shelf positions* | |
| 6 Grill heating element | |

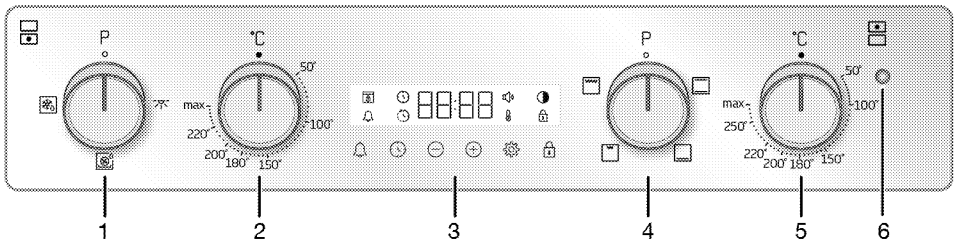

- | |
|--------------------------------|
| 1 Main oven function knob |
| 2 Main oven thermostat knob |
| 3 Digital timer |
| 4 Top oven function knob |
| 5 Top oven thermostat knob |
| 6 Thermostat lamp for top oven |

Package contents

i Accessories supplied can vary depending on the product model. Not every accessory described in the user manual may exist on your product.

1. User manual

2. Standard tray

Used for pastries, frozen foods and big roasts.

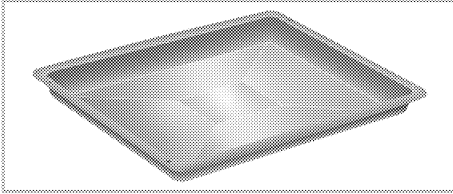

3. Wire grill

Used for roasting and for placing the food to be baked, roasted or cooked in casserole dishes to the desired rack.

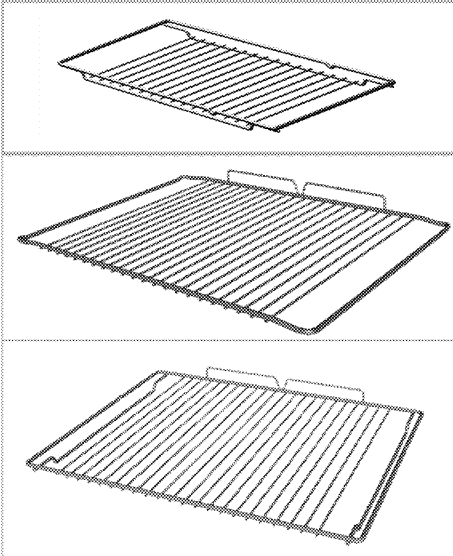

4. Small wire shelf

It is placed into the tray (if supplied) in order to collect the dripping fat while grilling so that the oven is kept clean.

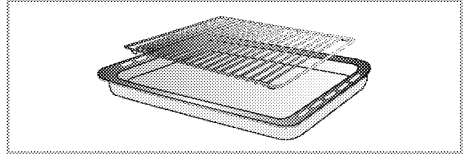

5. Placing the wire shelf and tray onto the telescopic racks properly (This feature is optional. It may not exist on your product.)

Telescopic racks allow you to install and remove the trays and wire shelf easily.

When using the tray and wire shelf with telescopic racks, make sure that the pins at the rear section of the telescopic rack stands against the edges of the wire shelf and tray.

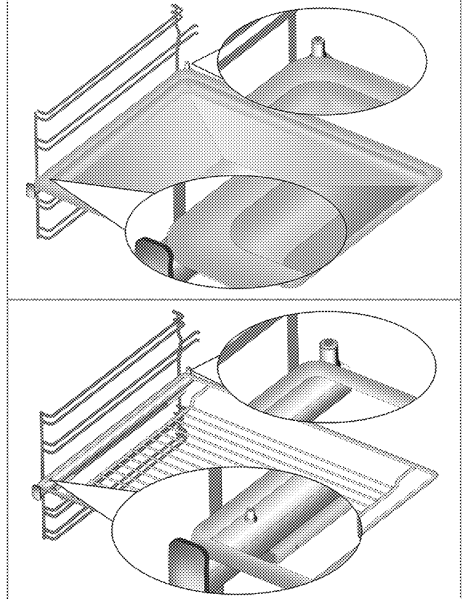

Technical specifications

GENERAL	
Voltage / frequency	220-240 V ~ 50 Hz
Total power consumption	4,3 kW
Fuse	25 A
Cable type / section	min.H05VV-FG 3 x 2,5 mm ² or equivalent
OVEN/GRILL	
External dimensions (height / width / depth)	890 mm/594 mm/567 mm
Installation dimensions (height / width / depth)	880 mm/560 mm/min. 550 mm
Main oven	Fan oven
Inner lamp	15/25 W
Top oven	Conventional oven / Grill
Inner lamp	15/25 W
Grill power consumption	2,5 kW

Basics: Information on the energy label of electrical ovens is given in accordance with the EN 60350-1 / IEC 60350-1 standard. Those values are determined under standard load with bottom-top heater or fan assisted heating (if any) functions.

Energy efficiency class is determined in accordance with the following prioritization depending on whether the relevant functions exist on the product or not. 1-Cooking with eco-fan, 2- Turbo slow cooking, 3- Turbo cooking, 4- Fan assisted bottom/top heating, 5-Top and bottom heating.

** See. *Installation, page 13.*

 Technical specifications may be changed without prior notice to improve the quality of the product.

 Figures in this manual are schematic and may not exactly match your product.

 Values stated on the product labels or in the documentation accompanying it are obtained in laboratory conditions in accordance with relevant standards. Depending on operational and environmental conditions of the product, these values may vary.

3 Installation

Product must be installed by a qualified person in accordance with the regulations in force. The manufacturer shall not be held responsible for damages arising from procedures carried out by unauthorized persons which may also void the warranty.

 Preparation of location and electrical installation for the product is under installer's responsibility.



 The product must be installed in accordance with all local electrical regulations.

 Prior to installation, visually check if the product has any defects on it. If so, do not have it installed. Damaged products cause risks for your safety.

Before installation

The appliances must not be installed behind a decorative door in order to avoid overheating.

The appliance is intended for installation in commercially available kitchen cabinets. A safety distance must be left between the appliance and the kitchen walls and furniture. See figure (values in mm).

- Surfaces, synthetic laminates and adhesives used must be heat resistant (100 °C minimum).
 - Kitchen cabinets must be set level and fixed.
 - If there is a drawer beneath the oven, a shelf must be installed in order to separate from the oven and drawer.
 - Carry the appliance with at least two persons.
 - Hold the oven from the slots for handling on both sides to move it.
 - Before installing the product, remove all materials and documents inside.
 - Kitchen furniture must be in compliance with the dimensions given in the figure below. At the rear section of the kitchen furniture, an opening must be cut out with the dimensions given in the figure below to ensure sufficient ventilation.
 - The following installation drawings are representational and may not match exactly with your appliance.
-  Do not install the appliance next to refrigerators or freezers. The heat emitted by the appliance will lead to an increased energy consumption of cooling appliances.
-  The door and/or handle must not be used for lifting or moving the appliance.

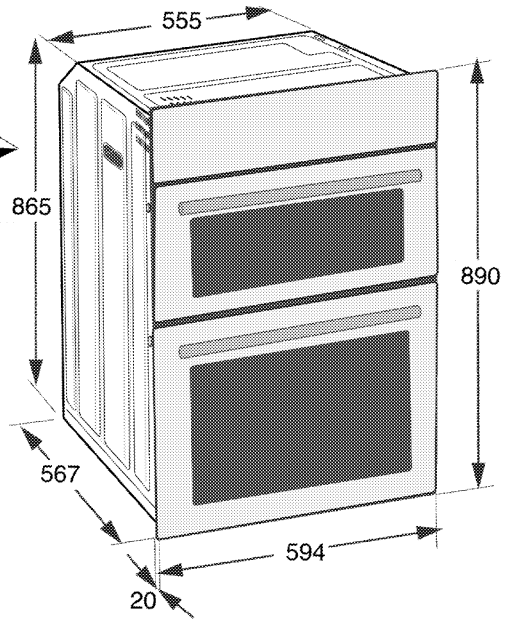
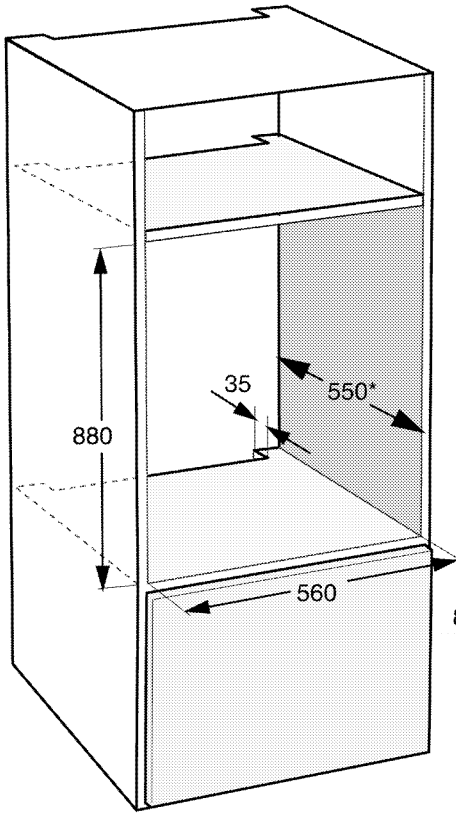

* min.

Installation and connection

- The product must be installed in accordance with all local gas and electrical regulations.

Electrical connection

Connect the product to a grounded outlet/line protected by a miniature circuit breaker of suitable capacity as

stated in the "Technical specifications" table. Have the grounding installation made by a qualified electrician while using the product with or without a transformer. Our company shall not be liable for any damages that will arise due to using the product without a grounding installation in accordance with the local regulations.

! The product must be connected to the mains supply only by an authorised and qualified person. Manufacturer shall not be held responsible for damages arising from procedures carried out by unauthorised persons.

! The power cable must not be clamped, bent or trapped or come into contact with hot parts of the product.
A damaged power cable must be replaced by a qualified electrician. Otherwise, there is risk of electric shock, short circuit or fire!

- Connection must comply with national regulations.
- The mains supply data must correspond to the data specified on the type label of the product. Open the front door to see the type label.
- Power cable of your product must comply with the values in "Technical specifications" table.

! Before starting any work on the electrical installation, disconnect the product from the mains supply.
There is the risk of electric shock!

Connecting the power cable

1. If a power cable is not supplied together with your product, a power cable that you would select from the table in accordance with the electrical installation at your home must be connected to your product by following the instructions in cable diagram.

This product must only be connected by a qualified electrician such as a technician from the local electricity company or NICEIC registered contractor to a suitable double-pole

control unit with a minimum contact clearance of 3 mm in all poles. This control unit must be installed accordance with the IEE regulation. Failure to obey this instruction may cause operational problems and invalidate the product warranty.

i Additional protection by a residual current circuit breaker is recommended.

2. Open the terminal block cover with a screwdriver.
3. Insert the power cable through the cable clamp below the terminal and secure it to the main body with the integrated screw on cable clamping component.
4. Connect the cables according to the supplied diagram.

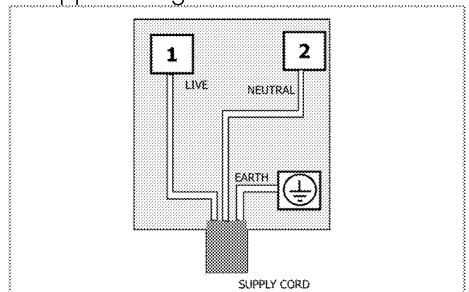

5. After completing the wire connections, close the terminal block cover.
6. Route the power cable so that it will not come into contact with the product and get squeezed between the product and the wall.

i Power cable must not be longer than 2 m because of safety reasons.

Installing the product

1. Slide the oven into the cabinet, align and secure it while making sure that the power cable is not broken and/or trapped.

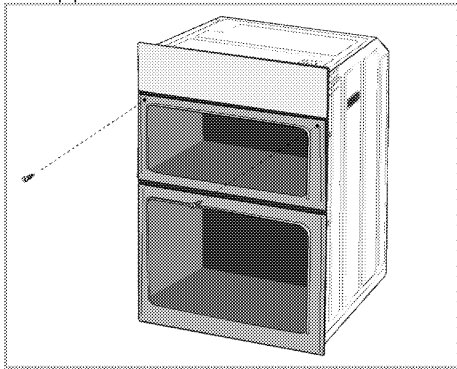

Secure the oven with 2 screws as illustrated.

After the installation, make sure that the screws are sufficiently tightened and the oven does not move. Oven may tip over during use if it is not installed as per the instructions and if the screws are not sufficiently tightened.

For products with cooling fan (This may not exist on your product.)

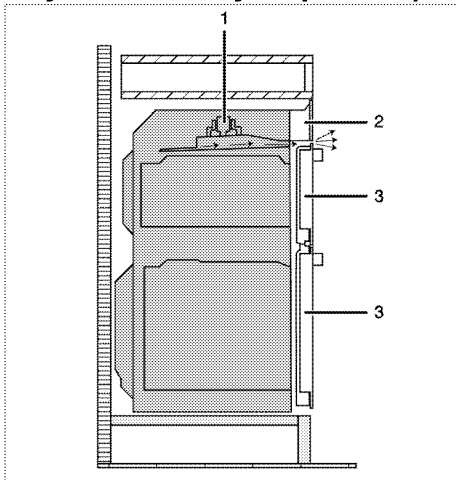

- 1 Cooling fan

- 2 Control panel

- 3 Door

The built-in cooling fan cools both the built-in cabinet and the front of the product.

- i** Cooling fan continues to operate for about 20-30 minutes after the oven is switched off.

If you have cooked by programming the timer of the oven, cooling fan will also be switched off at the end of the cooking time together with all functions.

Final check

1. Operate the product.
2. Check the functions.

Future Transportation

- Keep the product's original carton and transport the product in it. Follow the instructions on the carton. If you do not have the original carton, pack the product in bubble wrap or thick cardboard and tape it securely.
- To prevent the wire grill and tray inside the oven from damaging the oven door, place a strip of cardboard onto the inside of the oven door that lines up with the position of the trays. Tape the oven door to the side walls.
- Do not use the door or handle to lift or move the product.

- i** Do not place any objects onto the product and move it in upright position.

- i** Check the general appearance of your product for any damages that might have occurred during transportation.

4 Preparation

Tips for saving energy

The following information will help you to use your appliance in an ecological way, and to save energy:

- Use dark coloured or enamel coated cookware in the oven since the heat transmission will be better.
- While cooking your dishes, perform a preheating operation if it is advised in the user manual or cooking instructions.
- Do not open the door of the oven frequently during cooking.
- Try to cook more than one dish in the oven at the same time whenever possible. You can cook by placing two cooking vessels onto the wire shelf.
- Cook more than one dish one after another. The oven will already be hot.
- You can save energy by switching off your oven a few minutes before the end of the cooking time. Do not open the oven door.
- Defrost frozen dishes before cooking them.

Initial use

Time setting

- i** Always set the time of day before using your oven. If you do not set it, you cannot cook in some oven models.

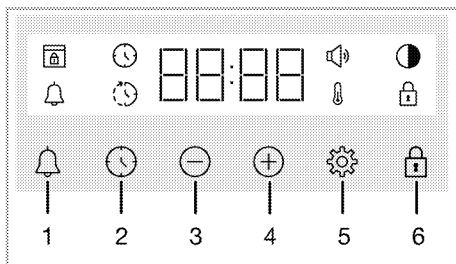

1 Alarm key

2 Time setting key

3 Decrease key

4 Increase key

5 Settings key

6 Key lock key

Display symbols

: Cooking time symbol

: Cooking end time symbol*

: Alarm symbol

: Brightness symbol

: Key lock symbol

: Temperature symbol

: Volume symbol

: Door lock symbol*

* It varies depending on the product model. It may not be available on your product.

1. When after the oven is energized for the first time, hour field "12:00" and symbol will flash on the display.

2. Set the time of day by touching .

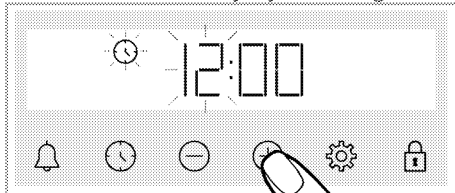

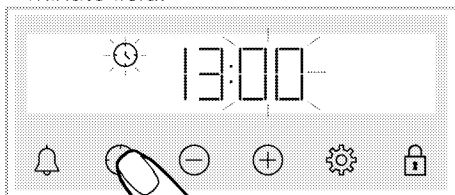

3. Touch or key to activate the minute field.



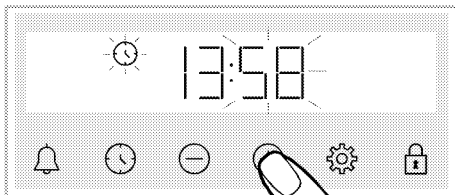



4. Set the minute of day by touching .



5. Confirm the setting by touching the  or  key.

» The time of day is set and the  symbol disappears on the screen.

 If the first time is not set, "12:00" and  symbols continue to flash and your oven will not start. For your oven to work, you must confirm the time of the day by setting the time of the day or touching the  key when it is at "12:00". You can change the time of day setting later, as described in the "Settings" section.

 Current time settings are canceled in case of power failure. It needs to be re-adjusted.

First cleaning of the appliance

 The surface might get damaged by some detergents or cleaning materials.
Do not use aggressive detergents, cleaning powders/creams or any sharp objects during cleaning.
Do not use harsh abrasive cleaners or sharp metal scrapers to clean the oven door glass since they can scratch the surface, which may result in shattering of the glass.

1. Remove all packaging materials.
2. Wipe the surfaces of the appliance with a damp cloth or sponge and dry with a cloth.

Initial heating

Heat up the product for about 30 minutes and then switch it off. Thus, any production residues or layers will be burnt off and removed.



Hot surfaces cause burns!
Product may be hot when it is in use. Never touch the hot burners, inner sections of the oven, heaters and etc. Keep children away.
Always use heat resistant oven gloves when putting in or removing dishes into/from the hot oven.

Electric oven

1. Take all baking trays and the wire grill out of the oven.
2. Close the oven door.
3. Select Static position.
4. Select the highest grill power; See *How to operate the electric oven, page 20*.
5. Operate the oven for about 30 minutes.
6. Turn off your oven; See *How to operate the electric oven, page 20*



Smoke and smell may emit for a couple of hours during the initial operation. This is quite normal. Ensure that the room is well ventilated to remove the smoke and smell. Avoid directly inhaling the smoke and the smell that emits.

5 How to operate the oven

General information on baking, roasting and grilling



Hot surfaces cause burns! Product may be hot when it is in use. Never touch the hot burners, inner sections of the oven, heaters and etc. Keep children away. Always use heat resistant oven gloves when putting in or removing dishes into/from the hot oven.



Be careful when opening the oven door as steam may escape. Exiting steam can scald your hands, face and/or eyes.

Tips for baking

- Use non-sticky coated appropriate metal plates or aluminum vessels or heat-resistant silicone moulds.
- Make best use of the space on the rack.
- Place the baking mould in the middle of the shelf.
- Select the correct rack position before turning the oven or grill on. Do not change the rack position when the oven is hot.
- Keep the oven door closed.

Tips for roasting

- Treating whole chicken, turkey and large piece of meat with dressings such as lemon juice and black pepper before cooking will increase the cooking performance.
- It takes about 15 to 30 minutes longer to roast meat with bones when compared to roasting the same size of meat without bones.
- Each centimeter of meat thickness requires approximately 4 to 5 minutes of cooking time.

- Let meat rest in the oven for about 10 minutes after the cooking time is over. The juice is better distributed all over the roast and does not run out when the meat is cut.
- Fish should be placed on the middle or lower rack in a heat-resistant plate.

Tips for grilling

When meat, fish and poultry are grilled, they quickly get brown, have a nice crust and do not get dry. Flat pieces, meat skewers and sausages are particularly suited for grilling as are vegetables with high water content such as tomatoes and onions.

- Distribute the pieces to be grilled on the wire shelf or in the baking tray with wire shelf in such a way that the space covered does not exceed the size of the heater.
- Slide the wire shelf or baking tray with grill into the desired level in the oven. If you are grilling on the wire shelf, slide the baking tray to the lower rack to collect fats. The baking tray to be slid must be of a size that covers the whole grilling area. This tray might not be provided with the product. Add some water in the baking tray for easy cleaning.



Foods that are not suitable for grilling carry the risk of fire. Only grill food which is suitable for intensive grilling heat. Do not place the food too far in the back of the grill. This is the hottest area and fatty food may catch fire.

How to operate the electric oven

Product is equipped with two ovens. Overview section indicates the relevant knobs for each oven.

How to operate the main oven

Select temperature and operating mode

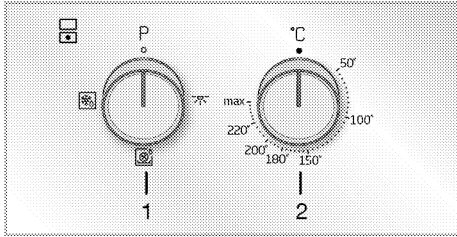

- 1 Main oven function knob
- 2 Main oven thermostat knob

Turning on the oven

When you select an operating function you want to cook with using the function selection knob and set a certain temperature with using the temperature knob, the oven starts operating.

Turning off the oven



You can turn the oven off by turning the function selection knob and temperature knob to the off (up) position.

Manual cooking to select temperature and oven operating function

You can cook by making a manual control (at your own control) without setting the cooking time by selecting the temperature and operating function specific to your food.

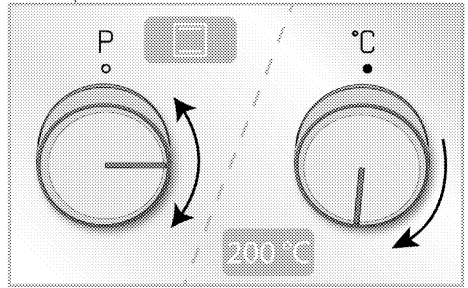
Example:



1. Select the operating function you want to cook using the function selection knob.
2. Set the temperature you want to cook using the temperature knob.
» Your oven will start operating immediately at the selected function and temperature and  will appear on the screen. When the temperature inside the oven reaches the set temperature, the  symbol disappears. The oven does not switch off automatically since manual cooking is done without setting the cooking time. You have to control cooking yourself and turn it off. When your cooking is completed, turn off the oven by turning the function selection knob and the temperature knob to the off (up) position.

Rack positions (For models with wire shelf)

It is important to place the wire shelf onto the side rack correctly. Wire shelf must be inserted between the side racks as illustrated in the figure.

Do not let the wire shelf stand against the rear wall of the oven. Slide your wire shelf to the front section of the rack and settle it with the help of the door in order to obtain a good grill performance. (Varies depending on the product model.)

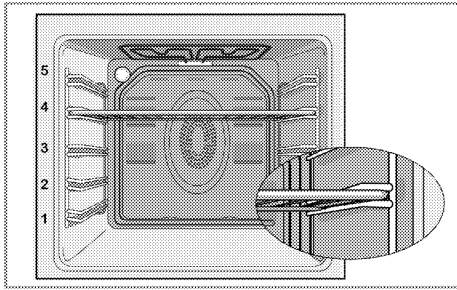

Operating modes

All functions in your oven (including the main oven) are described in this section. The order of operating modes shown here may be different from the arrangement on your product.

Oven lamp



The oven is not heated. Only the oven lamp is turned on. Possibly, the external cooling fan will also operate to avoid heating of the compartments.

Top and bottom heating



Top and bottom heating are in operation. Food is heated simultaneously from the top and bottom. For example, it is suitable for cakes, pastries, or cakes and casseroles in baking moulds. Cook with one tray only.

Bottom heating



Only bottom heating is in operation. It is suitable for pizza and for subsequent browning of food from the bottom.

Operating with fan



The oven is not heated. Only the fan (in the rear wall) is in operation. Suitable for thawing frozen granular food slowly at room temperature and cooling down the cooked food.

Fan Heating



Warm air heated by the rear heater is evenly distributed throughout the oven rapidly by means of the fan.



It is suitable for cooking your meals in different rack levels and preheating is not required in most cases. Suitable for cooking with multi trays. This function must be used for easy steam cleaning as well.

Grill



Small grill at the ceiling of the oven is in operation. Suitable for grilling.

- Put small or medium-sized portions in correct shelf position under the grill heater for grilling.
- Turn the food after half of the grilling time.

Full grill



Large grill at the ceiling of the oven is in operation. It is suitable for grilling large amount of meat.

- Put big or medium-sized portions in correct rack position under the grill heater for grilling.
- Turn the food after half of the grilling time.

Using the oven clock

i The oven clock only controls the bottom oven. It has no effect for the top oven.

General warnings

i Maximum time that can be set for end of cooking is 5 hours 59 minutes.

Program will be cancelled in case of power failure. You must reprogram the oven.

i While making any adjustments, the relevant symbols flash on the display. Please wait a short time for the settings to be saved.

i If any cooking setting has been made, the time of the day cannot be adjusted.

i If cooking time is set when cooking starts, the remaining time is displayed on the screen.



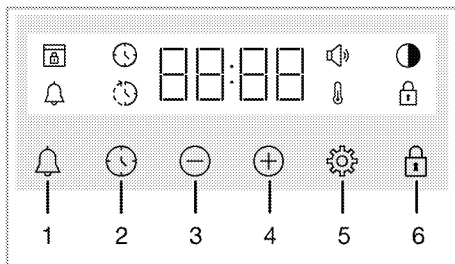



i In cases where cooking time or cooking end time is set; you can cancel automatically by touching the  key for a long time.



- 1 Alarm key
- 2 Time setting key
- 3 Decrease key
- 4 Increase key
- 5 Settings key
- 6 Key lock key

Display symbols



 : Cooking time symbol

-  : Cooking end time symbol*
-  : Alarm symbol
-  : Brightness symbol
-  : Key lock symbol
-  : Temperature symbol
-  : Volume symbol
-  : Door lock symbol*



* It varies depending on the product model. It may not be available on your product.

Cooking by setting the cooking time;

You can have the oven turn off automatically at the end of the time by selecting the temperature and operating function specific to your food and setting the cooking time on the timer.

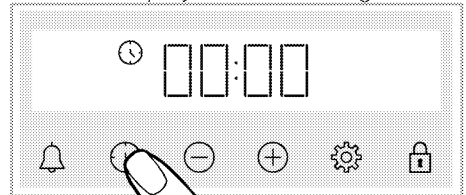
1. Select the operating function for cooking.
2. Touch  until the  symbol appears on the display for the cooking time.



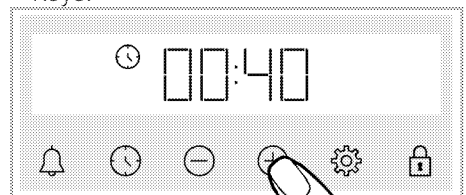

i After setting the operation function and temperature, you can set the cooking time for 30 minutes by touching the  key directly for quick setting of the cooking time and change the time with the  keys.

3. Set the cooking time with the  keys.



i The cooking time increases by 1 minute in the first 15 minutes, after 15 minutes it increases by 5 minutes.

4. Put your food in the oven and set the temperature with the temperature knob.



» Your oven will start operating immediately at the selected function and temperature. The set cooking time starts to count down and  appears on the display. When the temperature inside the oven reaches the set temperature, the  symbol disappears.

5. After the set cooking time is completed, on the screen, "End" appears, the  symbol flashes and the timer beeps



6. The warning sounds for two minutes. Press any key to stop the warning. The warning stops and the time of day appears on the screen.

To set the cooking end time to a later time; (It varies depending on the product model. It may not be available on your product.)

By selecting the temperature and operating function specific to your meal, you can set the cooking time and the cooking end time to a later time, allowing the oven to start and turn off automatically.

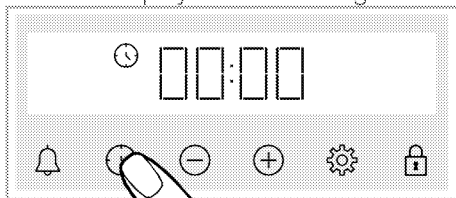
1. Select the operating function for cooking.
2. Touch  until the  symbol appears on the display for the cooking time.



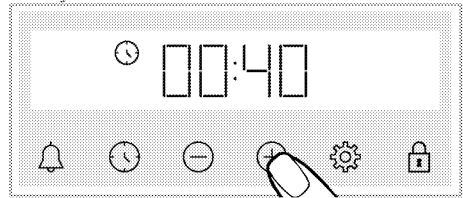

i After setting the operation function and temperature, you can set the cooking time for 30 minutes by touching the  key directly for quick setting of the cooking time and change the time with the  keys.

3. Set the cooking time with the  keys.



i The cooking time increases by 1 minute in the first 15 minutes, after 15 minutes it increases by 5 minutes.

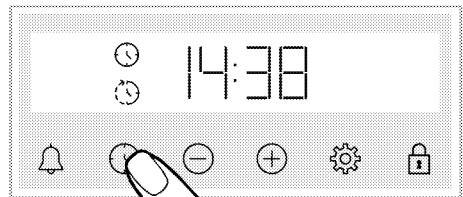

» After the cooking time has been set, the  symbol is constantly displayed on the screen.

4. Touch  until the  symbol appears on the display for the cooking end time.



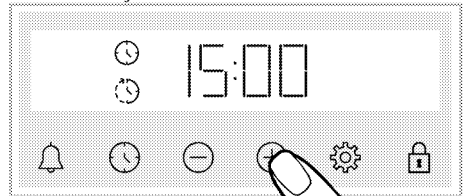

5. Set the cooking end time with the  keys.



» After the cooking end time is set, the  symbol and the  symbol with the time period symbol will appear constantly on the display. As soon as cooking starts, the  symbol disappears.

6. Put your food in the oven and set the temperature with the temperature knob.

» **The oven time calculates the time to start cooking by subtracting the cooking time from the cooking end time you set.** When the cooking start time comes, the selected function is activated and the oven heats up to the set temperature. The set cooking time starts to count down and  appears on the display. When the temperature inside the oven reaches the set temperature, the  symbol disappears.

7. After the set cooking time is completed, on the screen, "End" appears, the  symbol flashes and the timer beeps



8. The warning sounds for two minutes. Press any key to stop the warning. The warning stops and the time of day appears on the screen.

 If any key is pressed at the end of the audible warning, the oven will start operating again. To prevent the oven from operating again at the end of the warning, get the temperature knob and function knob to the "0" position (off) and turn the oven off.



Settings

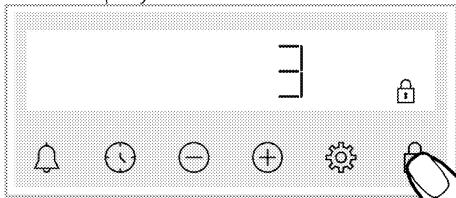

Activating key lock

You can prevent control unit from being intervened with by activating the key lock function.

1. Touch  until the  symbol appears on the display.





» The  symbol appears and the 3-2-1 countdown begins on the display. When the countdown is over, the key lock is activated. When any key is touched when the key lock is set, the timer sounds an audible signal and the  symbol flashes.

 If you stop touching the  If you stop tapping the X key before the countdown ends, the key lock will not be activated. key before the countdown ends, the key lock will not be activated.

 Timer keys cannot be used when key lock is on. The key lock will not be canceled in case of power failure.

Deactivating the key lock

1. Touch  until the  symbol disappears



» The  symbol disappears and the key lock is disabled on the display.

Setting the alarm

You can also use the timer of the product for any warning or reminder other than cooking.

The alarm clock has no effect on the oven operating functions. Used for warning purposes. For example, you can use the alarm clock when you want to turn the food in the oven at a certain time. As soon as the time you set has expired, the clock gives you an audible warning.

 Maximum alarm time can be 23 hours and 59 minutes.

1. Touch  until the  symbol appears on the display.

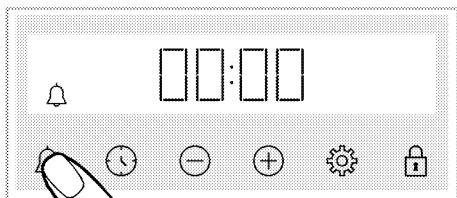

2. ⊕ Set the alarm time with the /⊖ keys.

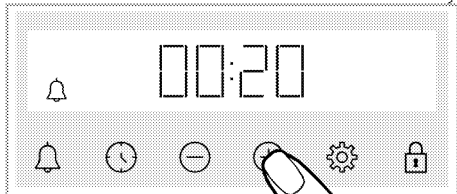

» After setting the alarm time, the 🔔 symbol remains lit and the alarm time starts the countdown the display. If the alarm time and cooking time are set at the same time, the shorter time is displayed on the display.

3. After the alarm time is completed, the 🔔 symbol starts flashing and gives you an audible warning.

Turning off the alarm

1. At the end of the alarm period, the warning audio for two minutes. Touch any key to stop the warning audio.

» The warning audio stops and the time of day appears on the display.

If you want to cancel the alarm;

1. Touch 🔔 until the 🔔 symbol appears on the display to reset the alarm. Touch the ⊖ key until it shows "00:00".

2. 🔔 you can also cancel the alarm by long pressing the key.

Changing the volume level

1. Touch the ⚙️ key until 🔊 symbol appears on the display.

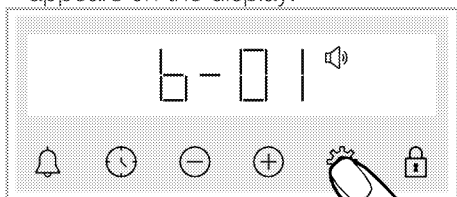

2. Set the desired level with the ⊕/⊖ keys. ("b-1"- "b-2"- "b-3")

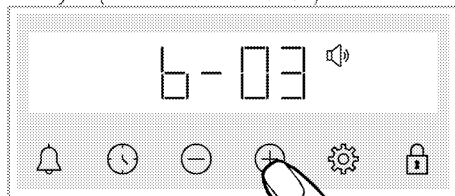

3. Touch the ⚙️ key for confirmation, or the setting is activated shortly without touching a key.

Setting the display brightness

1. Touch the 🌑 key until 🔊 symbol appears on the display.

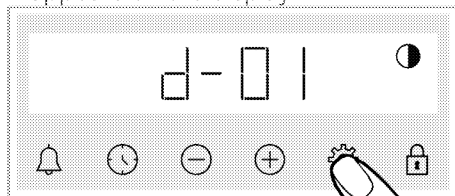

2. Set the desired brightness with the ⊕/⊖ keys. (d-01-d-02-d-03)

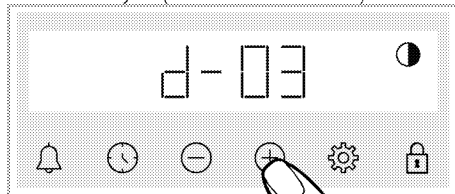

» Touch the ⚙️ key for confirmation, or the setting is activated shortly without touching a key.

Changing the time of day

On your oven; to change the time of day that you have previously set,

1. Touch ⚙️ until the 🕒 symbol appears on the display.

2. Set the time of day by touching ⊕/⊖.

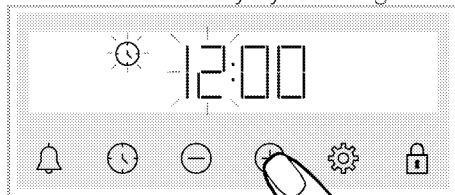

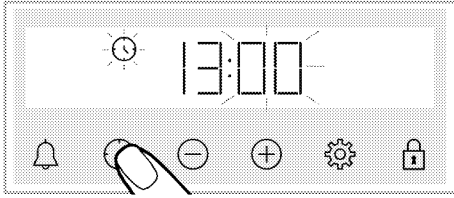

3. Touch  or  key to activate the minute field.

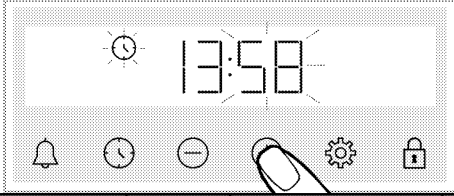

4. Set the minute of day by touching .



5. Confirm the setting by touching the  or  key.

















» The time of day is set and the  symbol disappears on the screen.







Cooking times table

 The timings in this chart are meant as a guide. Timings may vary due to temperature of food, thickness, type and your own preference of cooking.

Baking and roasting

 1st rack of the oven is the **bottom** rack.











Dish	Cooking level number	Accessory to use	Operating mode	Rack position	Temperature (°C)	Cooking time (approx. in min.)
Cakes in tray	One level	Standard tray*		3	180	25 ... 30
Cakes in mould	One level	Cake mold on wire grill**		2	180	40 ... 50
Small cakes	One level	Standard tray*		3	150	30 ... 40
	2 levels	1-Pastry tray* 3-Standard tray*		1 - 3	150	35 ... 50
	3 levels	1-Standard tray* 3-Pastry tray* 5-Deep tray*		1 - 3 - 5	150	35 ... 50
Sponge cake	One level	Round springform pan with a diameter of 26 cm on wire grill**		2	150	30 ... 40
	2 levels	1-Round springform pan with a diameter of 26 cm on wire grill** 4-Round springform pan with a diameter of 26 cm on pastry tray**		1 - 4	150	35 ... 45
Cookies	One level	Pastry tray*		3	180	25 ... 30
	2 levels	1-Pastry tray* 3-Standard tray*		1 - 3	180	30 ... 40
	3 levels	1-Pastry tray* 3-Standard tray* 5-Deep tray*		1 - 3 - 5	180	35 ... 45
Dough pastry	One level	Standard tray*		3	200	30 ... 40
	2 levels	1-Pastry tray* 5-Standard tray*		1 - 5	200	45 ... 55
	3 levels	1-Pastry tray* 3-Standard tray* 5-Deep tray*		1 - 3 - 5	200	55 ... 65
Rich pastry	One level	Standard tray*		3	200	25 ... 35
	2 levels	1-Pastry tray* 3-Standard tray*		1 - 3	200	35 ... 45
	3 levels	1-Pastry tray* 3-Standard tray* 5-Deep tray*		1 - 3 - 5	190	45 ... 55

Dish	Cooking level number	Accessory to use	Operating mode	Rack position	Temperature (°C)	Cooking time (approx. in min.)
Leaven	One level	Standard tray*		2	200	35 ... 45
Lasagna	One level	Glass/metal rectangular pan on wire grill**		3	200	30 ... 40
Beef steak (whole) / Roast	One level	Standard tray*		3	25 min. 250/max, then 180 ... 190	100 ... 120
Leg of Lamb (casserole)	One level	Standard tray*		3	25 min. 220 then 180 ... 190	70 ... 90
Roasted chicken (1,8-2 kg)	One level	Standard tray*		2	15 min. 250/max, then 190	70 ... 90
Turkey (5,5 kg)	One level	Standard tray*		1	25 min. 250/max, then 190	150 ... 210
Fish	One level	Standard tray*		3	200	20 ... 30

It is suggested to perform preheating for all foods.
* These accessories may not be supplied with the product.
** These accessories are not supplied with the product. They are commercially available accessories.

Cooking table for test meals

Meals in this cooking table are prepared according to EN 60350-1 to make it easier for control institutes to test the product.

Dish	Cooking level number	Accessory to use	Operating mode	Rack position	Temperature (°C)	Cooking time (approx. in min.)
Shortbread	One level	Standard tray*		3	140	20 ... 30
	2 levels	1-Standard tray* 3-Pastry tray*		1 - 3	140	20 ... 30
	3 levels	1-Standard tray* 3-Pastry tray* 5-Deep tray*		1 - 3 - 5	140	25 ... 35
Small cakes	One level	Standard tray*		3	150	30 ... 40
	2 levels	1-Pastry tray* 3-Standard tray*		1 - 3	150	35 ... 50
	3 levels	1-Standard tray* 3-Pastry tray* 5-Deep tray*		1 - 3 - 5	150	35 ... 50
Sponge cake	One level	Round springform pan with a diameter of 26 cm on wire grill**		2	150	30 ... 40
	2 levels	1-Round springform pan with a diameter of 26 cm on wire grill** 4-Round springform pan with a diameter of 26 cm on pastry tray**		1 - 4	150	35 ... 45
Apple pie	One level	Round black metal dish with a diameter of 20 cm on wire grill**		2	170	50 ... 60
	2 levels	1-Round black metal dish with a diameter of 20 cm on wire grill** 4-Round black metal dish with a diameter of 20 cm on pastry tray**		1 - 4	170	50 ... 60

It is suggested to perform preheating for all foods.
* These accessories may not be supplied with the product.
** These accessories are not supplied with the product. They are commercially available accessories.

Tips for baking cake

- If the cake is too dry, increase the temperature by 10°C and decrease the cooking time.
- If the cake is wet, use less liquid or lower the temperature by 10°C.
- If the cake is too dark on top, place it on a lower rack, lower the temperature and increase the cooking time.
- If cooked well on the inside but sticky on the outside use less liquid, lower the temperature and increase the cooking time.

Tips for baking pastry

- If the pastry is too dry, increase the temperature by 10°C and decrease the cooking time. Dampen the layers of dough with a sauce composed of milk, oil, egg and yoghurt.
- If the pastry takes too long to bake, pay care that the thickness of the pastry you have prepared does not exceed the depth of the tray.
- If the upper side of the pastry gets browned, but the lower part is not cooked, make sure that the amount of sauce you have used for the pastry is not too much at the bottom of the pastry. Try to scatter the sauce equally between the dough layers and on the top of pastry for an even browning.



Cook the pastry in accordance with the mode and temperature given in the cooking table. If the bottom part is still not browned enough, place it on one lower rack next time.

Tips for cooking vegetables

- If the vegetable dish runs out of juice and gets too dry, cook it in a pan with a lid instead of a tray. Closed vessels will preserve the juice of the dish.

- If a vegetable dish does not get cooked, boil the vegetables beforehand or prepare them like canned food and put in the oven.

How to operate the top oven

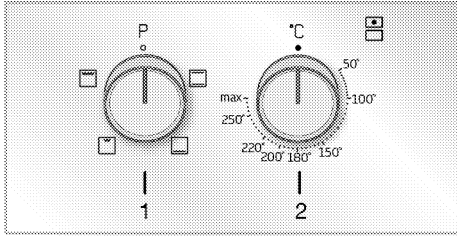

- 1 Top oven function knob
- 2 Top oven thermostat knob

Operating modes of the electric oven are selected with Function knob. Temperature setting is made with Thermostat knob.

All oven functions are turned off by turning the relevant knob to Off (upper) position.

Select temperature and operating mode

1. Set the Thermostat knob to the desired temperature.
2. Set the Function knob to the desired operating mode.

» Oven heats up to the adjusted temperature and maintains it. During heating and cooling, thermostat light turns on.

Switching off the electric oven

Turn the Function knob and thermostat knob to Off (upper) position.

- i** While cooking is in progress, when the electricity is cut and comes back again, the top oven continues to operate. In case of any power failure, make sure to turn off the oven.

Cooking times table

- i** The timings in this chart are meant as a guide. Timings may vary due to temperature of food, thickness, type and your own preference of cooking.
- i** Maximum load capacity of oven tray: 4 kg (8.8 lb).
- i** 1st rack of the oven is the **bottom** rack.
- Do not place cookware with rough bases on the oven door.
- Ensure that there is at least 25mm space at top of oven when cooking larger foods or using taller cookware.

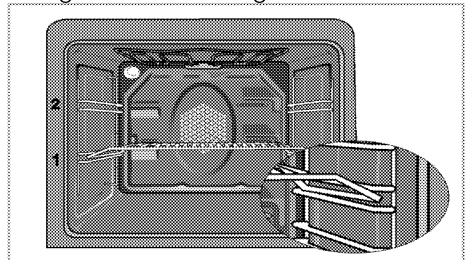

It is important to position the wire grill on the wire shelf correctly. The wire grill must be placed so that it will fit into the opening of the wire shelf as illustrated in the figure.

When removing tray from top oven, pull as shown in picture and hold with two hands from two sides.

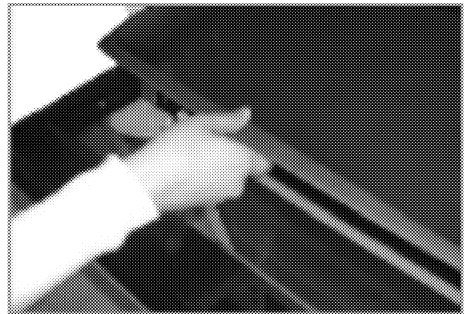

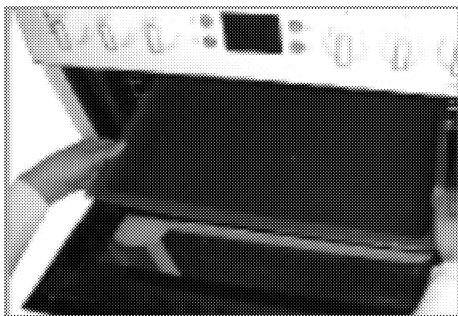

Baking and roasting

Dish	Cooking level number	Accessory to use	Operating mode	Rack position	Temperature (°C)	Cooking time (approx. in min.)
Cakes in tray	One level	Standard tray*		1	180	40 ... 50
Small cakes	One level	Standard tray*		1	160	35 ... 45
Cookies	One level	Standard tray*		1	180	30 ... 40
Dough pastry	One level	Standard tray*		1	200	30 ... 40
Rich pastry	One level	Standard tray*		1	200	25 ... 35
Leaven	One level	Standard tray*		1	200	35 ... 45
Pizza	One level	Standard tray*		1	200-220	15 ... 20
Beef steak (whole) / Roast	One level	Standard tray*		1	25 min. 250 then 180 ... 190	100 ... 120
Leg of Lamb (casserole)	One level	Standard tray*		1	25 min. 220 then 180 ... 190	70 ... 90
Roasted chicken (Sliced)	One level	Standard tray*		1	15 min. 250 then 190	65 ... 80
Fish	One level	Standard tray*		2	200	20 ... 30

* These accessories may not be supplied with the product.

How to operate the top grill

! Close oven door during grilling.
Hot surfaces may cause burns!

Switching on the grill

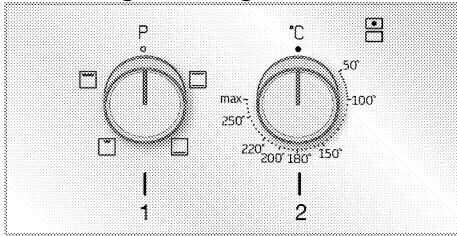

- 1 Top oven function knob
 - 2 Top oven thermostat knob
1. Set the Function knob to Grill symbol.
 2. Set the temperature to maximum level.
 3. If required, perform a preheating of about 5 minutes.
- » Thermostat (temperature) light turns on.

Switching off the grill

1. Turn the Grill control knob to Off (upper) position.
- i** While cooking is in progress, when the electricity is cut and comes back again, the top oven continues to operate. In case of any power failure, make sure to turn off the oven.

- Put big or medium-sized portions in correct rack position under the grill heater for grilling.

- For food only whose top is required to be roasted, grill the food either by placing onto the wire grill in the tray or by placing the tray onto the floor of grilling compartment.
- Food and plates placed onto the floor of grill compartment will get heated when the main oven is in use. Do not switch on the grill compartment when using it for storing food.

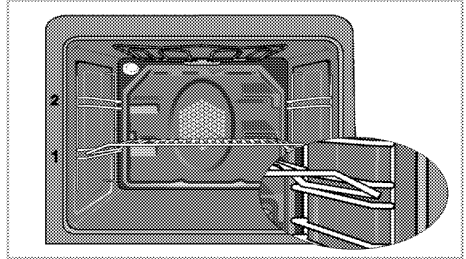

Foods that are not suitable for grilling carry the risk of fire. Only grill food which is suitable for intensive grilling heat. Do not place the food too far in the back of the grill. This is the hottest area and fatty food may catch fire.

Top oven cooking times table for grilling

Grilling with electric grill

- i** 1st rack of the oven is the **bottom** rack.

Food	Insertion level	Recommended temperature (°C)	Grilling time (approx.)
Fish	1	250	20...25 min. #
Sliced chicken	1	250	25...35 min.
Lamb chops	1	250	20...25 min.
Roast beef	1	250	25...30 min. #
Veal chops	1	250	25...30 min. #
Toast bread*	1	250	1...3 min.

depending on thickness
*Preheat for 5 minutes

6 Maintenance and care

General cleaning information

⚠ General warnings

- Wait for the product to cool before cleaning the product. Hot surfaces may cause burns!
- Do not apply the detergents directly on the hot surfaces. This may cause a permanent stains.
- The appliance shall be thoroughly cleaned and dried after each operation. Thus, food residues shall be easily cleaned and these residues shall be prevented from burning when the appliance is used again later. Thus, the service life of the appliance extends and frequently faced problems are decreased.
- Do not use steam cleaning products for cleaning.
- Some detergents or cleaning agents may damage the surface. Do not use abrasive detergents, cleaning powders, cleaning creams, descalers or sharp objects during cleaning.
- There is no need for a special cleaning agent for cleaning after each use. Clean the appliance using dish soap, warm water and a soft cloth or sponge and dry with a dry microfiber cloth.
- Be sure to completely wipe off any remaining liquid after cleaning and immediately clean any food splashing around during cooking.
- Do not wash any component of your appliance in a dishwasher.

Inox and stainless surfaces

- Do not use acid or chlorine-containing cleaning agents to clean stainless or inox surfaces and handles.

- Stainless or inox surface may change colour in time. This is normal. After each operation, clean with a detergent suitable for the stainless or inox surface.
- Clean with a soft soapy cloth and liquid (non-scratching) detergent suitable for inox surfaces, taking care to wipe in one direction.
- Remove lime, oil, starch, milk and protein stains on the inox-stainless and glass surfaces immediately without waiting. Stains may rust under long periods of time.

Enamelled surfaces

- After each use, clean the enamel surfaces using dishwashing detergent, warm water and a soft cloth or sponge and dry them with a dry cloth.
- If your product has an easy steam cleaning function, you can make easy steam cleaning for light non-permanent dirt. (See the "Easy steam cleaning" section)
- You may use the Quick&Shine cleaning agents for the oven interiors and grills and non-scratching scouring wire, used on enamelled surfaces and recommended by the authorized service, for persistent stains. Do not use an external oven cleaner.
- The oven must cool down for cleaning in the cooking area. Cleaning on hot surfaces shall create both fire hazard and damage with enamel surface.

Catalytic surfaces

- The side walls in the cooking area can only be covered with enamel or catalytic walls. It varies by model.
- The catalytic walls have a light matte and porous surface. The catalytic walls of the oven should not be cleaned.

- Catalytic surfaces absorb oil thanks to its porous structure and start to shine when the surface is saturated with oil, in this case it is recommended to replace the parts.

Glass surfaces

- When cleaning glass surfaces, do not use hard metal scrapers and abrasive cleaning materials. They can damage the glass surface.
- Clean the appliance using dishwashing detergent, warm water and a microfiber cloth specific for glass surfaces and dry it with a dry microfiber cloth.
- If there is residual detergent after cleaning, wipe it with cold water and dry with a clean and dry microfiber cloth. Residual detergent residue may damage the glass surface next time.
- Under no circumstances should the dried-up residue on the glass surface be cleaned off with serrated knives, wire wool or similar scratching tools.
- You can remove the calcium stains (yellow stains) on the glass surface with the commercially available descaling agent, with a descaling agent such as vinegar or lemon juice.
- If the surface is heavily soiled, apply the cleaning agent on the stain with a sponge and wait a long time for it to work properly. Then clean the glass surface with a wet cloth.
- Discolorations and stains on the glass surface are normal and not defects.

Plastic parts and painted surfaces

- Clean plastic parts and painted surfaces using dishwashing detergent, warm water and a soft cloth or sponge and dry them with a dry cloth.
- Do not use hard metal scrapers and abrasive cleaners. It may damage the surfaces.

- Ensure that the joints of the components of the appliance are not left as damp and with detergent. Otherwise, corrosion may occur on these joints.

Cleaning the accessories

Unless otherwise stated in the user manual, do not wash the product accessories in the dishwasher.

Cleaning the control panel

- When cleaning the panels with knob control, wipe the panel and knobss with a damp soft cloth and dry with a dry cloth. Do not remove the knobs and gaskets underneath to clean the control panel. The control panel and knobs may be damaged.
- While cleaning the inox panels with knob control, do not use inox cleaning agents around the knobs. The indicators around the knobs may be deleted.
- Clean the touch control panels with a damp soft cloth and dry with a dry cloth. If your product has a key lock feature, set the key lock before performing control panel cleaning. Otherwise, incorrect detection may occur on the keys.

Cleaning the inside of the oven (cooking area)

Follow the cleaning steps described in the "General cleaning information" section according to the surface types in your oven.

Cleaning the side walls of the oven

The side walls in the cooking area can only be covered with enamel or catalytic walls. It varies by model. If there is a catalytic wall, refer to the "Catalytic walls" section for information. If your product is a side rack model, remove the side racks before cleaning

your side walls. Then complete the cleaning as described in the "General cleaning information" section according to the side wall surface type.

To remove the side racks:(Varies depending on the product model.) (This feature is optional. It may not exist on your product.)

- 1.Remove the front section of the side rack by pulling it in the opposite direction of the side wall.
- 2.Remove the side rack completely by pulling it towards you.

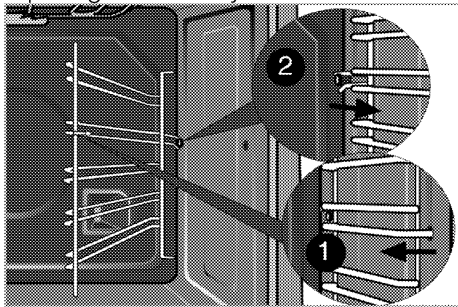

Easy Steam Cleaning

It ensures easy cleaning because the dirt (having waited not for too long) is softened with the steam that forms inside the oven and the water drops condensing on the inner surfaces of the oven.

- 1.Remove all accessories inside the oven.
- 2.Pour 500 ml of water into the oven tray and place the tray at the 2nd rack of the oven.

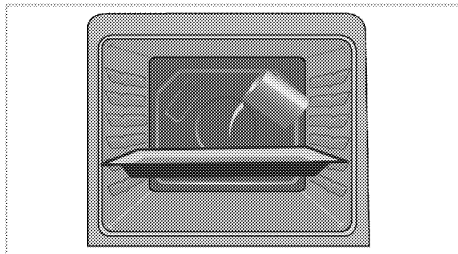

- 3.Set the oven to easy steam cleaning mode and run at 100°C for 25 minutes.
- 4.Open the door and wipe the inner surfaces of the oven with a damp sponge or cloth.
- 5.Use warm water with washing liquid, a soft cloth or sponge to clean the persistent dirt and wipe it with a dry cloth.

i During the easy steam cleaning mode, water that is placed in the tray to soften lightly formed residues/dirt within the oven cavity will evaporate and condense in the oven cavity and inner glass of the oven door, therefore water may drip when the oven door is opened. Wipe away the condensation as soon as the oven door is opened.

- 6.It varies depending on the product model. It may not be available on your product. After condensation in the oven, there might be water or moisture in the pool channel under the oven. After use, clean this pool channel with a damp cloth and then dry it.

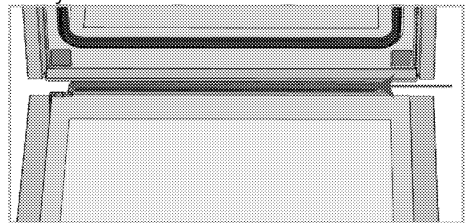

Cleaning the oven door

i Do not use harsh abrasive cleaners, metal scrapers, wire wool or bleach materials to clean the oven door and glass.

i The oven door inner glass is covered with an easy-to-clean material. Do not use abrasive cleaning agents, hard metal scrapers, wire wool or bleach materials such as bleach.

You can remove your oven door and door glasses to clean them. How to remove the doors and windows is explained in the sections "Removing the oven door" and "Removing the inner glasses of the door". After removing the door inner glasses, clean them using a dishwashing detergent, warm water and a soft cloth or sponge and dry them with a dry cloth. Wipe the glass with vinegar and then rinse it against lime residues that may occur on the oven glass.

Removing the oven door

1. Open the front door (1).
2. Open the clips at the hinge housing (2) on the right and left hand sides of the front door by pressing them down as illustrated in the figure.

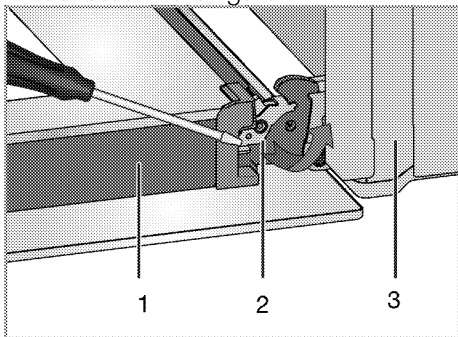

- 1 Door
- 2 Hinge lock(closed position)
- 3 Oven

4 Hinge lock(open position)

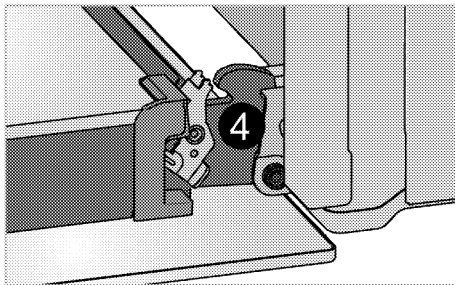

3. Move the front door to half-way.

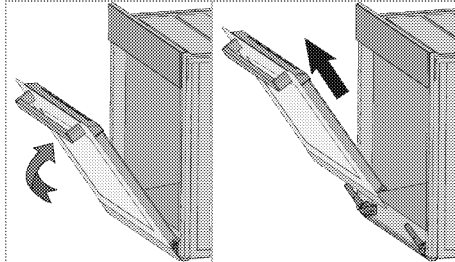

4. Remove the front door by pulling it upwards to release it from the right and left hinges.

i Steps carried out during removing process should be performed in reverse order to install the door. Do not forget to close the clips at the hinge housing when reinstalling the door.

Removing the door inner glass

(This feature is optional. It may not exist on your product.)

The entire inner glass panel of the oven door can be removed for cleaning.

1. Open the oven door.

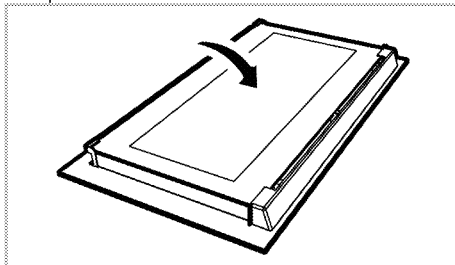

2. Pull towards yourself and remove the plastic part installed to upper section of the front door.

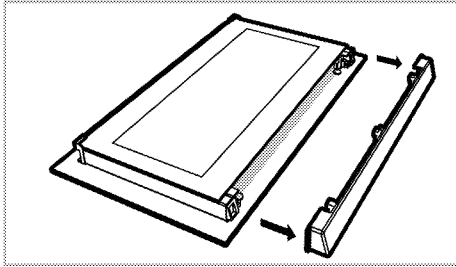

3. As illustrated in figure, raise the innermost glass panel (1) slightly in direction **A** and pull it out in direction **B**.

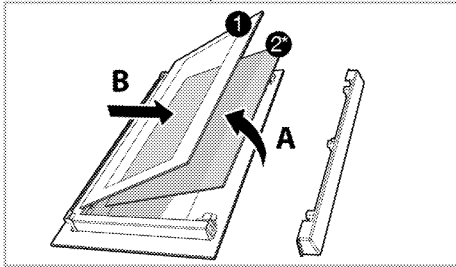

- 1 Innermost glass panel
- 2* Inner glass panel (This may not exist on your product.)
4. If your product is equipped with an inner glass panel; repeat the same procedure to remove the inner glass panel (2).
5. The first step to regroup the door is reinstalling inner glass panel (2). Place the chamfered corner of the glass panel so that it will rest in the chamfered corner of the plastic slot. (If your product is equipped with an inner glass panel). Inner glass panel (2) must be installed into the plastic slot close the innermost glass panel (1).
6. When installing the innermost glass panel (1), make sure that the printed side of the panel faces towards the inner glass panel. It is important to seat lower corner of innermost glass panel (1) into the lower plastic slot.

7. Push the plastic part towards the frame until you hear a "click".

Cleaning the oven lamp

In the event that the glass door of the oven lamp in the cooking area becomes dirty; clean using dishwashing detergent, warm water and a soft cloth or sponge and dry with a dry cloth. In case of oven lamp failure, you can replace the oven lamp by following the sections that follow.

Replacing the oven lamp

⚠ General warnings

- To avoid the risk of electric shock before replacing the oven lamp, disconnect the electrical connector and wait for the oven to cool. Hot surfaces may cause burns!
- The oven lamp is a special electric bulb resistant to 300 ° C. Oven lamps can be obtained from Authorized Services.
- The position of the lamp may differ from that is shown in the figure.
- The lamp used in this product is not suitable for use in the lighting of home rooms. The purpose of this lamp is to help the user see food products.
- The lamps used in this product must withstand extreme physical conditions such as temperatures above 50 ° C.

If your oven has a round lamp,

1. Disconnect the product from the electricity.
2. Remove the glass cover by turning it counterclockwise.

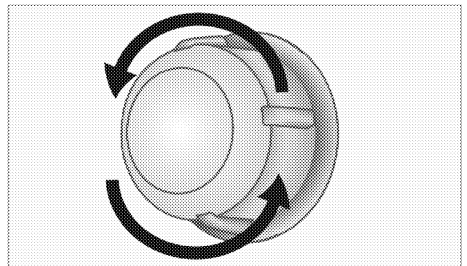

3. If your oven lamp is type (A) shown in the figure below, rotate the oven lamp as shown in the figure and replace it with a new one. If type (B) is a model, pull it out as shown in the figure and replace it with a new one.

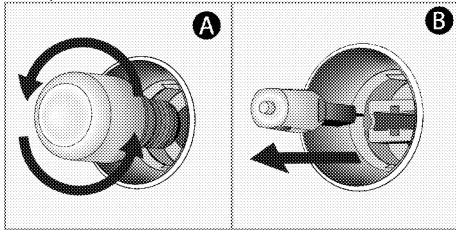

4. Refit the glass cover.

If your oven has a square lamp,

1. Disconnect the product from the electricity.
2. Remove the wire shelves according to the description.

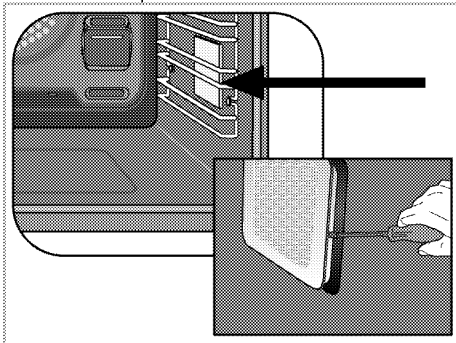

3. Lift the lamp's protective glass cover with a screwdriver.

4. If your oven lamp is type (A) shown in the figure below, rotate the oven lamp as shown in the figure and replace it with a new one. If type (B) is a model, pull it out as shown in the figure and replace it with a new one.

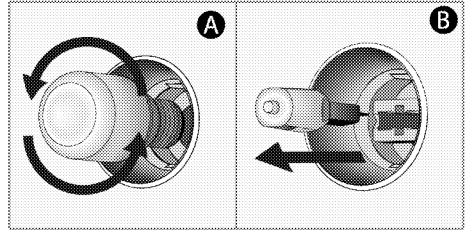

5. Refit the glass cover and wire shelves.

7 Troubleshooting

Oven emits steam when it is in use.

- It is normal that steam escapes during operation. >>> *This is not a fault.*

Product emits metal noises while heating and cooling.

- When the metal parts are heated, they may expand and cause noise. >>> *This is not a fault.*

Product does not operate.

- The mains fuse is defective or has tripped. >>> *Check fuses in the fuse box. If necessary, replace or reset them.*
- Product is not plugged into the (grounded) socket. >>> *Check the plug connection.*

Oven light does not work.

- Oven lamp is defective. >>> *Replace oven lamp.*
- Power is cut. >>> *Check if there is power. Check the fuses in the fuse box. If necessary, replace or reset the fuses.*

Oven does not heat.

- Might not be set to a certain cooking function and/or temperature. >>> *Set the oven to a certain cooking function and/or temperature.*
- In models equipped with a timer, the timer is not adjusted. >>> *Adjust the time.* (In products with microwave oven, timer controls only microwave oven.)
- Power is cut. >>> *Check if there is power. Check the fuses in the fuse box. If necessary, replace or reset the fuses.*

(In models with timer) Clock display is blinking or clock symbol is on.

- A previous power outage has occurred. >>> *Adjust the time / Switch of the product and switch it on again.*



Consult the Authorised Service Agent or technician with licence or the dealer where you have purchased the product if you can not remedy the trouble although you have implemented the instructions in this section. Never attempt to repair a defective product yourself.

8 Guarantee Details

BEKO UK AND IRELAND STANDARD MANUFACTURER GUARANTEE TERMS AND CONDITIONS

Your new Beko product is guaranteed against faulty materials, defective components or manufacturing defects.

The standard guarantee starts from the date of original purchase of the product, and lasts for a period of twelve (12) months unless Beko plc (the “Manufacturer”) agrees to extend the guarantee for the product in writing. If you have purchased an American style Fridge freezer, the standard guarantee starts from the date of original purchase of the product, and lasts for a period of twenty four (24) months unless Beko plc (the “Manufacturer”) agrees to extend the guarantee for the product in writing.

If you have any questions about the guarantee on your product (including how long it is valid), please contact your retailer or our contact centre on **0333 207 9710** (UK and Northern Ireland) or 01 862 3411 (Republic of Ireland)

This guarantee does not in any way diminish or affect your statutory rights in connection with the product. This guarantee is in addition to your statutory rights as a consumer. If you have any questions about these rights, please contact the retailer from which you purchased the product. In certain circumstances, it is possible that your statutory rights may offer additional or higher levels of protection than those offered under the terms of this guarantee.

What is covered by this guarantee?

- Repairs to the product required as a result of faulty materials, defective components or manufacturing defects.
- Functional replacement parts to repair a product.
- The costs of a Beko Approved Engineer to carry out the repair.

What is not covered?

- Transit and delivery damage.
- Cabinet or appearance parts, including but not limited to control knobs, flaps and handles.
- Accessories and/or consumable items including but not limited to ice trays, scrapers, cutlery baskets, filters and light bulbs.
- Repairs necessary as a direct or indirect result of:
 - Accidental damage, misuse or abuse of a product.
 - An attempted repair of a product by anyone other than a Beko Approved Engineer (the “Engineer”).
 - Installation or use of a product where such installation or use fails to meet the requirements contained in this guarantee or the User Instructions Booklet.

- Repairs to a product operated at any time on commercial or non-residential household premises (unless we have previously agreed to the installation environment).

This guarantee is limited to the cost of repairing the product. To the extent permitted by law, the Manufacturer does not accept and will not be held liable for any financial loss incurred in connection with the failure of any product to operate in accordance with the expected standards. Such financial loss includes but is not limited to loss arising from:

- Time taken off work.
- Damaged food, clothing or other items.
- Meals taken at restaurants or from takeaways.
- General compensation for inconvenience.

Important Notes

1. Your product is designed and built for domestic household use only.
2. The guarantee will automatically be void if the product is installed or is used in commercial or non-residential domestic household premises, unless we have previously agreed to the installation environment.
3. The product must be correctly installed, located and operated in accordance with the instructions contained in the User Instructions Booklet provided with your product.
4. Professional installation by a qualified Electrical Domestic Appliance Installer is recommended for all Washing Machines, Dishwashers and Electric Cookers (as incorrect installation may result in you having to pay for the cost of repairing the product).
5. Gas Cookers must be professionally installed by a Gas Safe (or Gas Networks Ireland for Republic of Ireland) registered gas installer.
6. This guarantee is given in respect of products purchased and used within the United Kingdom and the Republic of Ireland.
7. This guarantee is effective from the initial date of purchase of a new product from an authorised retailer and will be void if the product is resold.
8. This guarantee does not apply to graded sales (where the product is purchased as a "second").
9. Possession of a copy of these terms and conditions does not necessarily mean that a product has the benefit of this guarantee. If you have any questions, please call our Call Centre on the number set out above.
10. The Manufacturer reserves the right to terminate the guarantee if its staff or representatives are subjected to physical or verbal abuse in the course of carrying out their duties.
11. Optional extras, where available (i.e. extendable feet) are supplied on a chargeable basis only.

Does Beko offer replacements?

This is a repair-only guarantee. On occasion, the Manufacturer may at its sole discretion, replace your product with a new product instead of carrying out a repair. Where a replacement is offered, this would normally be an identical model but when this is not possible, a model of similar specification will be provided. The Manufacturer will cover the costs and arrange for the delivery of the new product and for the return of the old product. Any costs related to disconnecting the faulty product and installing the replacement product will not be borne by the Manufacturer unless previously agreed to in writing. The original guarantee will continue to apply to the replacement product; the new product will not come with a new guarantee.

When will the repair take place?

Our Engineers work Monday to Friday 9.00am to 5.00pm. Appointments outside these hours may be possible at the sole discretion of the Manufacturer but cannot be guaranteed. Whilst our Engineers will endeavour to minimize inconvenience and to meet requests for specific timed appointments, this cannot be guaranteed. We will not be liable for delays or if it is unable to carry out a repair because a convenient appointment cannot be arranged.

Will there be any charge for the repairs?

It is your responsibility to provide evidence to the Engineer that your product is covered by this guarantee with a proof of purchase. The Manufacturer reserves the right to charge for the reasonable cost of any service call if:

- You cannot provide evidence that your product is covered by this guarantee.
- Where a service call has been made and the engineer finds that there is no fault with your product.
- That your product has not been installed or operated in accordance with the User Instructions Booklet.
- That the fault was caused by something other than faulty materials, defective components or manufacturing defects.
- For missed appointments.

Payment of these costs are due immediately upon the Engineer providing you with an invoice. The Manufacturer reserves the right to terminate the guarantee if you fail to pay the costs for the service call in a timely manner.

If you are a resident of the United Kingdom, this guarantee will be governed by English law and subject to the English Courts, save where you live in another part of the United Kingdom, in which case the law and courts of that location will apply.

If you are resident in the Republic of Ireland, this guarantee will be governed by Irish law and the Irish courts will have jurisdiction.

This guarantee is provided by Beko plc. Beko House, 1 Greenhill Crescent, Watford, Hertfordshire. WD18 8QU.

Beko plc is registered in England and Wales with company registration number 02415578.

BEKO UK AND IRELAND BUILT-IN APPLIANCES GUARANTEE TERMS AND CONDITIONS

If you have purchased a built-in or integrated appliance, and registered it within 90 days of purchase by completing the online registration form, then the standard 12 month guarantee will be extended to 24 months, under the same terms and conditions as detailed in our Standard Guarantee Terms and Conditions.

BEKO UK AND IRELAND PROSMART INVERTER MOTOR GUARANTEE TERMS AND CONDITIONS

This 10 year guarantee relates to Beko products that feature the ProSmart Inverter Motor.

The ProSmart Motor guarantee terms and conditions are in addition to our Standard guarantee terms and conditions detailed in the previous section.

In order to activate the 10 year guarantee you MUST register the appliance within 90 days of the original purchase date. You can register by first visiting Beko.co.uk/register and by following the online instructions.

Beko Free standing appliances come with a 12 month parts and labour guarantee as standard,

Beko Built-in appliances come with a 12 month parts and labour guarantee as standard. This is extended to 24 months, free of charge, upon registration of the appliance. When you register your appliance for additional guarantee, you will automatically activate the ProSmart Motor 10 year guarantee. You do not need to register twice. (beko.co.uk/guarantee-terms).

To make a claim against your Beko ProSmart Inverter Motor Guarantee (the "Guarantee"), all customer and product details must be registered with Beko plc using the procedure outlined below.

1. This extra 9 years (for free standing appliances) or 8 years (for built-in or integrated appliances) guarantee is only effective after the expiration of the standard manufacturer's guarantee.
2. It is only valid for the ProSmart Inverter motors of selected washing machines, washer-dryers, tumble dryers and dishwashers. It does not cover any labour charge or any other components of the product. In addition, it is only valid for one replacement of the ProSmart motor during the extra 9-year (for free standing appliances) or 8 year (for built-in appliances) guarantee period.
3. To activate your guarantee, you MUST register your appliance within 90 days of the original purchase date, by visiting beko.co.uk/register.
4. Customers will receive a unique reference code as proof of guarantee validation by email or post, which must be quoted at the time of a claim being made.
5. Any repair/replacement of the ProSmart Inverter motor must only be carried out by an authorised Beko Service Agent (the "Service Agent").
6. Labour for the repair/replacement of the ProSmart Inverter motor is not included in this guarantee and is chargeable directly by the Service Agent.
7. Any additional components fitted to the product at any time will not be covered by this guarantee and will be chargeable directly by the Service Agent.

8. The guarantee is not transferable and cannot be exchanged for cash.
9. There are no alternative or additional offers to this Guarantee.
10. The guarantee is exclusive of the manufacturer's standard guarantee.
11. The Terms and Conditions shown above are in addition to the standard terms and conditions of your product guarantee. Please read and refer to such Terms and Conditions when making any claim.
12. We may use the information you provide for marketing purposes and to analyse your purchasing preferences. We may keep your information for a reasonable period for these purposes in accordance with the applicable Data Protection Laws and General Data Protection Regulations (GDPR). You can opt into this service during the registration process. Further details are available at <http://www.beko.co.uk/cookie-and-privacy>.
13. These Terms and Conditions are governed by the laws of England and Wales; manufacturer: Beko plc, Beko House, 1 Greenhill Crescent, Watford WD18 8QU. Company Registration Number: 02415578.

HOW TO OBTAIN SERVICE FOR YOUR APPLIANCE

Please keep your purchase receipt or other proof of purchase details in a safe place; you will need to have this documentation available should the product require attention under guarantee.

Please take a few moments to complete the details below, as you will need this information when you call us, or to use our online services. When you call us you may be required to input your serial number into your telephone keypad. For help please visit beko.co.uk/support/model-finder

- The product model number is printed on the Operating Instruction Booklet / User guide
- The product model and serial number is printed on the Rating Label affixed to the appliance.
- The Retailer (Purchased from) and Date of purchase will be printed on your purchase receipt or other proof of purchase paperwork

Recording of these details alone will not count as proof of purchase. A valid proof of purchase is required for requesting service under guarantee.

Model number	Serial number	Purchased from	Date of purchase

For service under guarantee or for product advice please call our Contact centre

Before requesting service please check the troubleshooting guide in the Operating Instructions booklet, as a charge may be levied where no fault is found, and even though your product may still be under guarantee.

After arranging service the area around the product must be easily accessible to the Engineer, without the need for cabinets or furniture to be removed or moved.

It is your responsibility to ensure our Engineers have a clean and safe environment to carry out any repairs.

Please have your Model number and Serial number available when you call us, as you may be required to input your serial number into your telephone keypad during your call.

UK Mainland & Northern Ireland:

0333 207 9710

Landline or mobile calls to 0333 numbers cost no more than calls to geographic numbers 01 or 02, and are charged at the basic rate. Calls from landlines and mobiles are included in free call packages but please check with your telephone service provider for exact call charges.

Republic of Ireland:

01 862 3411

Service once the manufacturers guarantee has expired

If you have purchased an extended guarantee please refer to the instructions contained within the extended guarantee agreement document, otherwise please call us using the appropriate number above, where service can be obtained at a charge.

Should you experience any difficulty in obtaining service please call us on **0333 207 9710** or **01 862 3411**

Contact us through our website

Send us a secure message through our online contact us form. Please visit our website, click Contact Us and choose a product support topic from the list of options. Complete the required details and click send message.

Product registrations

For UK registrations please visit beko.co.uk/register and for the Republic of Ireland visit beko.ie/register.

Free Manuals Download Website

<http://myh66.com>

<http://usermanuals.us>

<http://www.somanuals.com>

<http://www.4manuals.cc>

<http://www.manual-lib.com>

<http://www.404manual.com>

<http://www.luxmanual.com>

<http://aubethermostatmanual.com>

Golf course search by state

<http://golfingnear.com>

Email search by domain

<http://emailbydomain.com>

Auto manuals search

<http://auto.somanuals.com>

TV manuals search

<http://tv.somanuals.com>