



Microwave Oven

User Manual



BMOB17131X

EN



Please read this manual first!

Dear Customer,

Thank you for purchasing a Beko product. We hope that you get the best results from your product which has been manufactured with high quality and state-of-the-art technology. Therefore, please read this entire user manual and all other accompanying documents carefully before using the product and keep it as a reference for future use. If you handover the product to someone else, give the user manual as well. Follow all warnings and information in the user manual.

Meanings of the symbols

Following symbols are used in the various section of this user manual:

| | |
|--|---|
|  | Important information and useful hints about usage. |
|  | Warnings for dangerous situations concerning the safety of life and property. |
|  | Warning for hot surfaces. |



This product has been manufactured in environmental friendly modern plants without giving any harm to the nature.

CONTENTS

1 Important safety and environmental instructions 4

- 1.1 Safety warnings 4
- 1.2 Compliance with the WEEE Directive and Disposing of the Waste Product: . 9
- 1.3 Compliance with RoHS Directive . 9
- 1.4 Package information 9
- 1.5 Plug Wiring 10

2 Technical Specifications of the Product 11

- 2.1 Overview 11
- 2.2 Technical data. 11
- 2.3 Installing the turntable. 12

3 Installation and connection 13

- 3.1 Built-in furniture 13
- 3.2 Install the Oven. 14

4 Operating your product 15

- 4.1 Control panel 15
- 4.2 Clock setting. 15
- 4.3 Cooking food 16
- 4.4 Pre-Set cooking 16
- 4.5 Defrost by weight 16
- 4.6 Defrost By Time 17
- 4.7 Multi-section cooking 17
- 4.8 Start/Quick start 17
- 4.9 Auto menu 17
- 4.10 Child Lock Function. 18
- 4.11 Inquiring Function 18

5 Cleaning and Care 19

- 5.1 Cleaning. 19
- 5.2 Storage 19

6 Trouble shooting 20

1 Important safety and environmental instructions

Important Safety Instructions Read Carefully And Keep For Future Reference

1.1 Safety warnings

This section contains safety instructions that will help protect from risk of fire, electric shock, exposure to leak microwave energy, personal injury or property damage. Failure to follow these instructions shall void any warranty.

- Beko Microwave Ovens comply with the applicable safety standards; therefore, in case of any damage on the appliance or power cable, it should be repaired or replaced by the dealer, service center or a specialist and authorized service alike to avoid any danger. Faulty or unqualified repair work may be dangerous and cause risk to the user.
- This appliance is intended to be used in household and similar applications such as:
 - Staff kitchen areas in shops, offices and other working environments;
 - Farm houses
 - By clients in hotels, and other residential type environments;
 - Bed and Breakfast type environments.
- It is not intended for industrial or laboratory use.
- Do not attempt to start the oven when its door is open; otherwise you may be exposed to harmful microwave energy. Safety locks should not be disabled or tampered with.
- The microwave oven is intended for heating food and beverages. Drying of food or clothing and heating of warming pads, slippers, sponges, damp cloth and similar may lead to risk of injury, ignition or fire.

1 Important safety and environmental instructions

- Do not place any object between the front side and the door of the oven. Do not allow dirt or cleaning agent remnants to build up on the closure surfaces.
- Any service works involving removal of the cover that provides protection against exposure to microwave energy must be performed by authorized persons/service. Any other approach is dangerous.
- Your product is intended for cooking, heating and defrost food at home. It must not be used for commercial purposes.
- Your oven is not designed to dry any living being.
- Do not use your appliance to dry clothes or kitchen towels.
- Do not use this appliance outdoors, bathrooms, humid environments or in places where the it can get wet.
- No responsibility or warranty claim shall be assumed for damages arising from misuse or improper handling of the appliance.
- Never attempt to dismantle the appliance. No warranty claims are accepted for damage caused by improper handling.
- Only use the original parts or parts recommended by the manufacturer.
- Do not leave this appliance unattended while it is in use.
- Always use the appliance on a stable, flat, clean dry, and non-slip surface.
- The appliance should not be operated with an external clock timer or separate remote control system.
- Before using the appliance for the first time, clean all parts. Please see the details given in the “Cleaning and Maintenance” section.
- Operate the appliance for its intended purpose only as described in this manual.
- Appliance becomes very hot while it is in use. Pay attention not to touch the hot parts inside the oven.
- Do not operate the oven empty.

1 Important safety and environmental instructions

- Cooking utensil may get hot due to the heat transferred from the heated food to the utensil. You may need oven gloves to hold the utensil.
- Utensils shall be checked to ensure that they are suitable for use in microwave ovens.
- Do not place the oven on stoves or other heat generating appliances. Otherwise, it may be damaged and the warranty becomes void.
- Steam may come out while opening the covers or the foil after cooking the food.
- The appliance and its accessible surfaces may be very hot when the appliance is in use.
- Door and outer glass may be very hot when the appliance is in use.
- Make sure that your mains power supply complies with the information supplied on the rating plate of the appliance.
- The only way to disconnect the appliance from the power supply is to remove the power plug from the power outlet.
- Use the appliance with a grounded outlet only.
- Never use the appliance if the power cable or the appliance itself is damaged.
- Do not use this appliance with an extension cord.
- Never touch the appliance or its plug with damp or wet hands.
- Place the appliance in a way so that the plug is always accessible.
- Prevent damage to the power cable by not squeezing, bending, or rubbing it on sharp edges. Keep the power cable away from hot surfaces and naked flame.
- Make sure that there is no danger that the power cable could be accidentally pulled or that someone could trip over it when the appliance is in use.
- Unplug the appliance before each cleaning and when the appliance is not in use.

1 Important safety and environmental instructions

- Do not pull the power cable of the appliance to disconnect it from its power supply and never wrap its power cable around the appliance.
- Do not immerse the appliance, power cable, or power plug in water or any other liquids. Do not hold it under running water.
- When heating food in plastic or paper containers, keep an eye on the oven due to the possibility of ignition.
- Remove the wire strings and/or metal handles of paper or plastic bags before placing bags to the oven.
- If smoke is observed, switch off or unplug the appliance if safe to do so and keep the door closed in order to stifle any flames.
- Do not use microwave oven for storage. Do not leave paper items, cooking material or food inside the oven when it is not being used.
- The contents of feeding bottles and baby food jars should be stirred or shaken and the temperature checked before consumption, in order to avoid burns.
- This appliance is a Group 2 Class B ISM equipment. Group 2 contains all ISM (Industrial, Scientific and Medical) equipment in which radio-frequency energy is intentionally generated and/or used in the form of electromagnetic radiation for the treatment of material, and spark erosion equipment.
- Class B equipment is suitable for use in domestic establishments and establishments directly connected to a low voltage power supply network.
- Do not use cooking oil in the oven. Hot oil may damage the components and materials of the oven, and it may even cause skin burns.
- Pierce food with thick crust such as potatoes, courgettes, apples and chestnuts.
- Appliance must be placed so that the rear side is facing the wall.

1 Important safety and environmental instructions

- Before moving the appliance, please secure the turntable to prevent damage.
- Eggs in their shell and whole hard-boiled eggs must not be heated in microwave ovens since they may explode, even after microwave heating has ended.

WARNING: If the door or door seals are damaged, the oven must not be operated until it has been repaired by a competent person.

WARNING: It is hazardous for anyone other than a competent person to carry out any service or repair operation which involves the removal of a cover which gives protection against exposure to microwave energy.

WARNING: Liquids and other foods must not be heated in sealed containers since they are liable to explode.

- The oven should be cleaned regularly and any food deposits removed.
- There should be min 20 cm free space above the top surface of the oven.
- Do not over-cook foods; otherwise, you may cause a fire.
- Do not use chemicals and steam assisted cleaners to clean the appliance.
- Extreme caution is advised when being used near children and persons who are restricted in their physical, sensory or mental abilities.
- This appliance can be used by the children who are at the age of 8 or over and by the people who have limited physical, sensory or mental capacity or who do not have knowledge and experience, as long as they are supervised with regard to safe use of the product or they are instructed accordingly or understand the risks of using the product. Children should not play with the appliance. Cleaning and user maintenance procedures should not be performed by children unless they are controlled by their elders.
- Danger of choking! Keep all the packaging materials away from children.

1 Important safety and environmental instructions

- Due to excessive heat that arises in grill and combination modes, children should only be allowed to use these modes under supervision of an adult.
- Keep the product and its power cable so that they are inaccessible by children under 8 years old.
- Do not cook food directly on the glass tray. Put the food in / on appropriate kitchen utensils before placing them in the oven.
- Metallic containers for food and beverages are not allowed during microwave cooking. Otherwise, sparking may occur.
- Microwave oven must not be placed in a cabinet that is not in compliance with the installation instructions.
- Microwave oven is intended for built-in use only.
- If built-in appliances being used equal or higher than 900 mm above the floor, care should be taken not to displace the turntable when removing containers from the appliance.
- If the built-in product is in a cabinet with a door, the product must be operated with the cabinet door open.

1.2 Compliance with the WEEE Directive and Disposing of the Waste Product:

This product complies with EU WEEE Directive (2012/19/EU). This product bears a classification symbol for waste electrical and electronic equipment (WEEE).

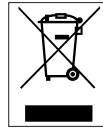

This symbol indicates that this product shall not be disposed with other household wastes at the end of its service life. Used device must be returned to official collection point for recycling of electrical and electronic devices. To find these collection systems please contact to your local authorities or retailer where the product was purchased. Each household performs important role in recovering and recycling of old appliance. Appropriate disposal of used appliance helps prevent potential negative consequences for the environment and human health.

1.3 Compliance with RoHS Directive

The product you have purchased complies with EU RoHS Directive (2011/65/EU). It does not contain harmful and prohibited materials specified in the Directive.

1.4 Package information



Packaging materials of the product are manufactured from recyclable materials in accordance with our National Environment Regulations. Do not dispose of the packaging materials together with the domestic or other wastes. Take them to the packaging material collection points designated by the local authorities.

1 Important safety and environmental instructions

1.5 Plug Wiring

The moulded plug on this appliance incorporates a 13 A fuse. Should the fuse need to be replaced an ASTA approved BS1362 fuse of the same rating must be used. Do not forget to refit the fuse cover. In the event of losing the fuse cover, the plug must not be used until a replacement fuse cover has been fitted. Colour of the replacement fuse cover must be the same colour as that visible on the pin face of the plug. Fuse covers are available from any good electrical store.

• Fiting a different plug

- As the colours of the wires in the mains lead of this appliance may not correspond with the coloured markings identifying the terminals on your plug, proceed as follows:
- Brown cable = L (Live)
- Blue cable = N (Neutral)
- Green/yellow cable must be connected to ground (E) \equiv line
- With the alternative plugs a 13 A fuse must be fitted either in the plug or adaptore or in the main fuse box. If in doubt contact a qualified electrician.

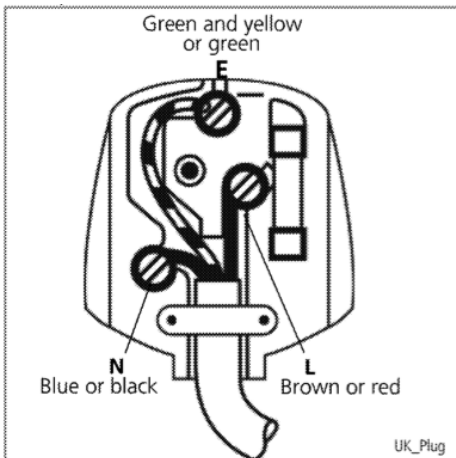

2 Technical Specifications of the Product

2.1 Overview

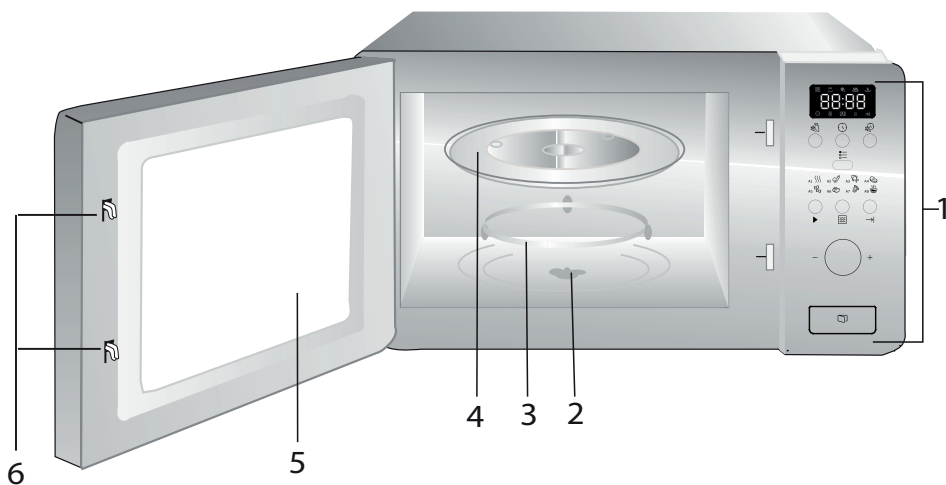

1. Control panel
2. Turntable shaft
3. Turntable support
4. Glass tray
5. Oven window
6. Door safety interlock system

2.2 Technical data

| | |
|--------------------------------------|----------------|
| Rated voltage: | 230 V~, 50 Hz |
| Operation frequency | 2450 MHz |
| Rated input power (microwave) | 1050 W |
| Rated output power(microwave) | 700 W |
| Oven capacity | 17 L |
| Turntable diameter | ø 245 mm |
| Timer | 0-95' |
| External dimensions | 595*336*382 mm |
| Net weight | 15 kg |

Technical and design modification rights are reserved.

Markings on the appliance or the values stated in other documents supplied with the product are values obtained under laboratory conditions as per relevant standards. These values may vary according to the usage of the appliance and ambient conditions.

2 Technical Specifications of the Product

2.3 Installing the turntable

- Never place the glass tray upside down. The glass tray should never be restricted.
- Both glass tray and turntable support must always be used during cooking.
- All food and containers of food must always place on the glass tray for cooking.
- If glass tray or turntable support crack or break, contact your nearest authorized service center.

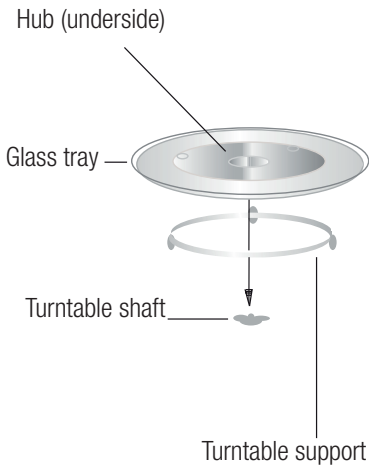

3 Installation and connection

3.1 Built-in furniture

The built-in cabinet shall not have a rear wall behind the appliance.

Minimum installation height is 85 cm.

Do not cover ventilation slots and air intake points.

1.

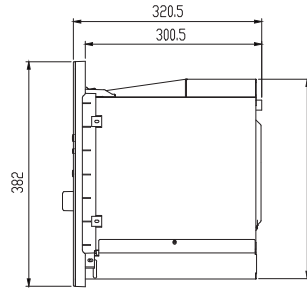
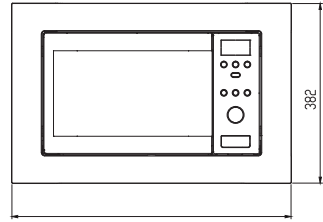
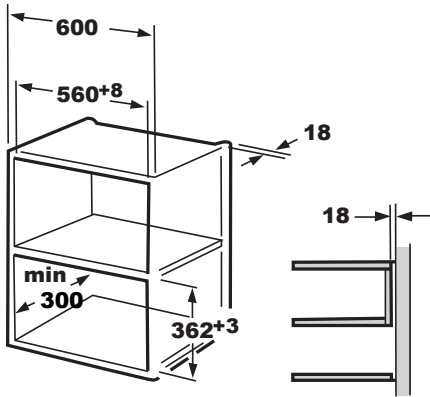

2.

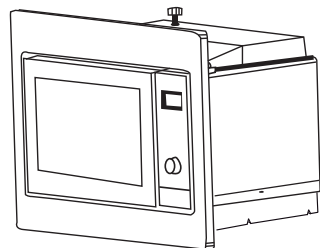
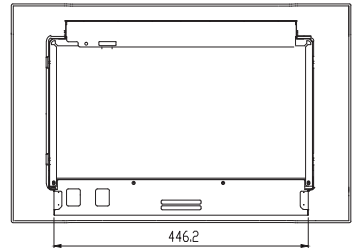
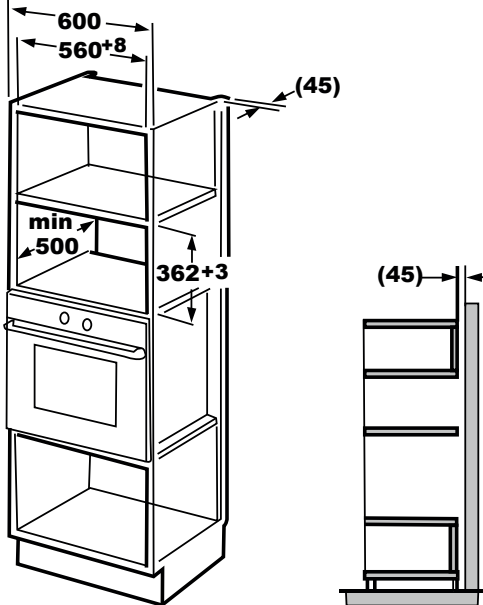

3 Installation and connection

3.2 Install the Oven

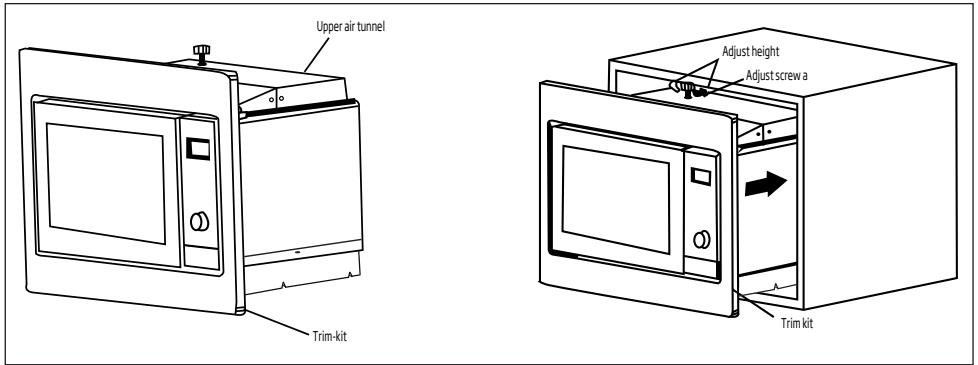

1. Install the oven into the cabinet.

- Do not trap or kink the power cord.
- Make sure that the oven is installed in the center of the cabinet.

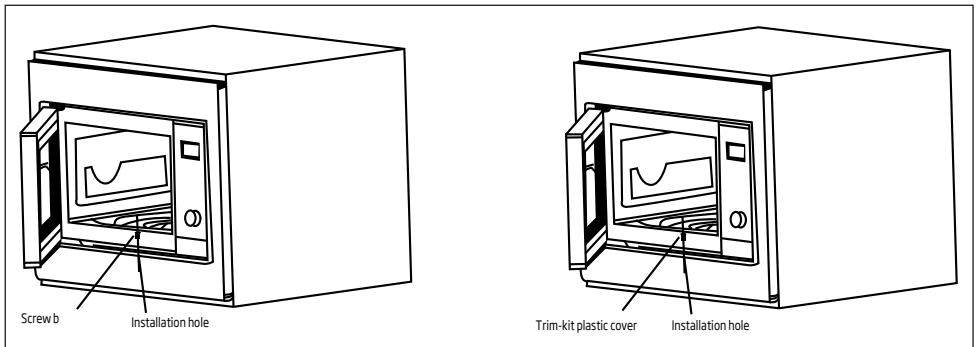

2. Open the door; fix the oven to the cabinet with screw b at the installation hole of trim kit. Then fix the trim-kit plastic cover to the installation hole.

4 Operating your product

4.1 Control panel

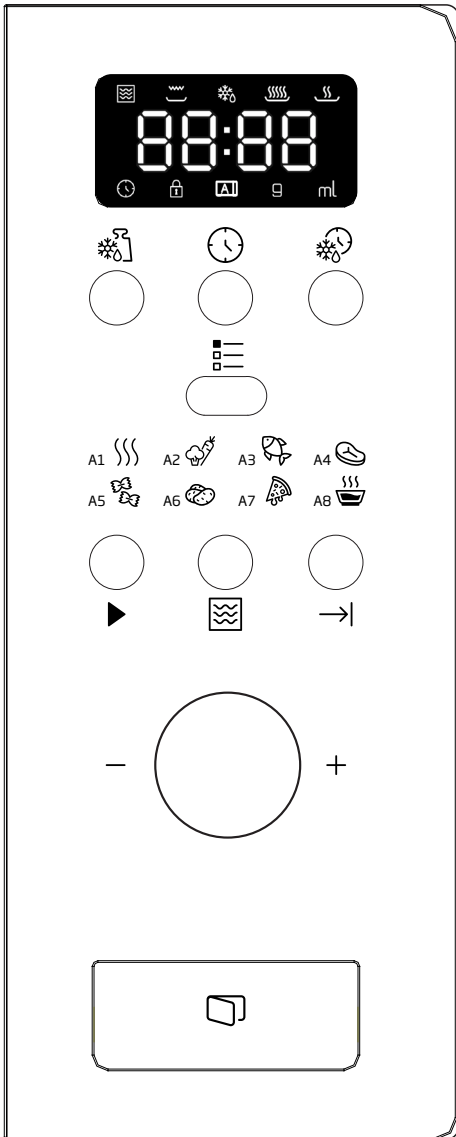

- Defrost By Weight
- Clock/ Pre-Set
- Defrost By Time
- Menu
- Quick Start/Start
- Microwave
- Cancel/Stop
- A-1 Auto Reheat
- A-2 Vegetable
- A-3 Fish
- A-4 Meat
- A-5 Pasta
- A-6 Potato
- A-7 Reheat Pizza
- A-8 Soup





4.2 Clock setting

When the microwave oven is electrified, the oven will display "0:00", buzzer will rings once.

1. Press "", the hour figures will flash, and the indicator for clock "" will light.
2. Turn "" to adjust the hour figures, the input time should be within 0--23.
3. Press "", the minute figures will flash.
4. Turn "" to adjust the minute figures, the input time should be within 0--59.
5. Press "" to finish clock setting. The indicator for clock "" will go out, ":" will flash, and the time will light.







4 Operating your product

4.3 Cooking food

1. Press , "P100" will flash.
2. Then turn  to select the power, "P100", "P80"... and "P10" will display in order.
3. Press  to confirm, and then turn  to select the cooking time.
4. Press  to start cooking.



Example: If you want to use 80% microwave to cook food for 20 minutes, you can operate the oven as the following steps.

1. Press , the screen display "P100".
2. Turn  to adjust 80% microwave power until the oven displays "P 80".
3. Press  to confirm, the screen displays "P 80".
4. Turn  to adjust the cooking time until the oven displays "20:00".
5. Press  to start cooking or press  to cancel the settings.

The step quantities for the adjustment time of the coding switch are as follow:

| | |
|------------|------------|
| 0--1 min | 5 seconds |
| 1--5 min | 10 seconds |
| 5--10 min | 30 seconds |
| 10--30 min | 1 minute |
| 30--95 min | 5 minutes |

"Microwave" Pad instructions





| Order | Display | Microwave Power |
|-------|---------|-----------------|
| 1 | P 100 | 100% |
| 2 | P 80 | 80% |
| 3 | P 50 | 50% |
| 4 | P 30 | 30% |
| 5 | P 10 | 10% |

4.4 Pre-Set cooking

Set the clock first. (Consult the instruction of clock setting.)











Example: If you want to use 80% microwave to cook food for 15 minutes, you can operate the oven as the following steps.





1. Press , the screen display "P100".
2. Turn  to adjust 80% microwave power until the oven displays "P 80".
3. Press  to confirm, the screen displays "P 80".
4. Turn  to adjust the cooking time until the oven displays "15:00".



Please do not press  to start cooking.

5. Press , the hour figures will flash, and the indicator  will light.
6. Turn  to adjust the hour figures, the input time should be within 0--23.
7. Press , the minute figures will flash.
8. Turn  to adjust the minute figures, the input time should be within 0--59.
9. Press  to finish setting. The indicator for clock  will flash. If the door is closed, buzzer will ring twice when the time start automatically and the indicator for clock  will go out.

4.5 Defrost by weight

1. Press  button. The screen will display "dEF1",  and  will light.
2. Turn  to select the weight of food. The weight is from 100 to 2000 g.

4 Operating your product

3. Press to start defrosting food. and will flash.

4.6 Defrost By Time

1. Press button. The screen will display “dEF2”, and will light.
2. Turn to select the cooking time. The MAX. time is 95 minutes.
3. Press to start defrosting food. and will flash.

4.7 Multi-section cooking

At most 3 sections can be input for cooking. In multi-section cooking, if one section is defrosting, then defrosting shall be placed in the first section.



Example: If you want to use “20 minutes of 100% microwave power + 5 minutes of 80% microwave power” to cook food.

1. Press pad, the screen display “P100”.
2. Press to confirm the microwave power.
3. Turn to select cooking time.
4. Press pad, the screen display “P100”.
5. Turn to select 80% microwave power.
6. Press pad, then turn to select cooking time of 80% microwave power.
7. Press to start cooking or press to cancel the setting.

4.8 Start/Quick start

When the oven is in the waiting state, press to start cooking food with full microwave power for 1 minute. Each press will increase one minute. The maximum cooking time is 95 minutes.

4.9 Auto menu





Example: If you want to use “Auto Menu” to cook fish of 250 g.

1. Press , and will light.
2. Turn to select the function you want.
3. Press button to confirm.
4. Turn to select the weight of fish. “g” will light.
5. Press to start. “g” will go out, and will flash.

The automatic menu procedure:

| Menu | Order | Weight | Display |
|---------------------|-------|--------------------------|---------|
| A-1 Auto Reheat | 1 | 200 g | 200 g |
| | | 400 g | 400 g |
| | | 600 g | 600 g |
| A-2 Vegetable | 2 | 200 g | 200 g |
| | | 300 g | 300 g |
| | | 400 g | 400 |
| A-3 Fish | 3 | 250 g | 250 g |
| | | 350 g | 350 g |
| | | 450 g | 450 g |
| A-4 Meat | 4 | 250 g | 250 g |
| | | 350 g | 350 g |
| | | 450 g | 450 g |
| A-5 Pasta | 5 | 50 g (with water 450ml) | 50 g |
| | | 100 g (with water 800ml) | 100 g |
| A-6 Potato | 6 | 200 g | 200 g |
| | | 400 g | 400 g |
| | | 600 g | 600 g |

4 Operating your product



| | | | |
|---|---|--------|--------|
|  A-7 Reheat Pizza | 7 | 200 g | 200 g |
| | | 400 g | 400 g |
|  A-8 Soup | 8 | 200 ml | 200 ml |
| | | 400 ml | 400 ml |

4.10 Child Lock Function

Lock: In waiting state, press “→” for 3 seconds, there will be a long beep denoting entering the children-lock state and oven will display “E E E E” and .

Lock quitting: In locked state, press “→” for 3 seconds, there will be a long “beep” denoting that the lock is released.

4.11 Inquiring Function

1. In microwave state, press “”, the current power will be displayed for 4 seconds. After 4 seconds, the oven will turn back to the former state;
2. In cooking state, press “” to inquire the present time and the time will flash for 4 seconds.
3. In preset state, press “” to inquire the preset time and it will flash for 4 seconds.

5 Cleaning and Care

5.1 Cleaning



WARNING: Never use gasoline, solvent, abrasive cleaning agents, metal objects or hard brushes to clean the appliance.



WARNING: Never immerse the appliance or its power cable in water or in any other liquid.

1. Turn the appliance off and disconnect it from wall socket.
2. Wait for the appliance to completely cool down.
3. Keep the inside of the oven clean. Wipe with a damp cloth when splashed food or spilled liquids stick on the walls of the oven. A mild detergent may be used if the oven gets very dirty. Avoid using sprays and other harsh cleaning agents as they may cause stains, marks, and opaqueness on the door surface.
4. Outer surfaces of the oven must be cleaned with a damp cloth. Do not allow water ingress from ventilation openings to prevent damage to the operating parts in the oven.
5. Wipe both sides of the door and the glass, door gaskets and parts near the gaskets frequently with a damp cloth in order to remove the overflowing and splashing stains. Do not use abrasive cleaning agents.
6. Do not allow control panel to get wet. Clean with a soft damp cloth. Leave the door of the oven open to prevent inadvertent operation while cleaning the control panel.
7. If steam accumulates inside or around the oven door, wipe with a soft cloth. This may occur when the microwave oven is operated under high humidity conditions. It is normal.
8. In some cases, you may need to remove the glass tray for cleaning. Wash the tray in warm soapy water or in a dishwasher.
9. The roller ring and oven floor should be cleaned regularly to avoid excessive noise.
10. It would be sufficient to wipe the lower surface of the oven with a mild detergent. Roller ring may be washed in warm soapy water or in a dishwasher. When you remove the roller ring from oven internal floor for cleaning, ensure that you install it in the correct position while replacing it.
11. In order to remove bad odors in your oven, put a glass of water and juice and peel of a lemon to a deep bowl suitable for use in microwave and operate the oven for 5 minutes in microwave mode. Wipe thoroughly and dry with a soft cloth.
12. Please contact the authorized service when the oven lamp needs to be replaced.
13. The oven should be cleaned regularly and any food deposits should be removed. If the oven is not kept clean, this may cause surface defects that would affect the lifecycle of the appliance negatively and that would possibly cause risks.
14. Please do not dispose this appliance with household waste; old ovens shall be disposed to special waste centers provided by the municipalities.
15. When the microwave oven is used in grill function, a small amount of smoke and odor may occur which will disappear after a certain time of usage.

5.2 Storage

- If you do not intend to use the appliance for a long time, please store it carefully.
- Please make sure that the appliance is unplugged, cooled down and totally dry.
- Store the appliance in a cool and dry place.
- Keep the appliance out of the reach of children.

6 Trouble shooting

| Normal | |
|---|---|
| Microwave oven interferes with TV reception | Radio and TV reception may be interfered when microwave oven is operating. It is similar to the interference caused by small electrical appliances, like mixer, vacuum cleaner, and electric fan. It is normal. |
| Oven light is dimmed | In low power microwave cooking, oven light may be dimmed. It is normal. |
| Steam accumulating on door, hot air coming out of vents | During cooking, steam may arise from the food. Most of this steam will get out from vents. But some may accumulate on a cool place like oven door. It is normal. |
| Oven started accidentally with no food in it. | It is not allowed to run the appliance without any food inside. It is very dangerous. |

| Problem | Possible Reason | Solution |
|--|---|--|
| Oven cannot be started. | 1) Power cable is not plugged in properly. | Unplug. Then plug again after 10 seconds. |
| | 2) Fuse is blown or circuit breaker is activated. | Replace fuse or reset circuit breaker (repaired by professional personnel of our company). |
| | 3) Trouble with outlet. | Test the outlet with other electrical appliances. |
| Oven does not heat. | 4) Door is not closed properly. | Close the door properly. |
| Glass turntable makes noise when microwave oven operates | 5) Turntable and bottom of the oven is dirty. | Refer to "Cleaning and Maintenance" section to clean dirty parts. |

Product Guarantee

12 months breakdown and repair guarantee

Guarantor: **Beko plc, 1 Greenhill Crescent, Watford, Hertfordshire. WD18 8UF**

The guarantee does not in any way diminish your statutory or legal rights.

Your **microwave** has the benefit of our manufacturer's guarantee which covers the product for 12 months from the date of original purchase.

This gives you reassurance that if within that time, your **microwave** is proven to be defective because of either workmanship or materials, we will at our discretion either repair or replace your **microwave**.

The **microwave** must be correctly installed, located and operated in accordance with the instructions contained in the user manual. The guarantor disclaims any liability for accidental or consequential damage.

The Guarantee is subject to the following conditions:

- Documentary proof of the original purchase date is provided.
- The microwave has been installed and operated correctly and in accordance with our operating and maintenance instructions.
- The microwave is used only on the electricity supply on the rating plate.
- The microwave has only been used for normal domestic purposes.
- The microwave has not been altered, serviced, dismantled or otherwise interfered with by any person.
- The microwave is used in the United Kingdom or Republic of Ireland.
- Any parts removed during repair work or any product that has been replaced becomes our property.
- The guarantee is not transferrable if the product is resold.

The Guarantee does not cover:

- Transit, installation or delivery damage.
- Accidental damage.
- Misuse or abuse.
- Replacement of any consumable item or accessories. These include but are not limited to: plugs, cables, light bulbs, knobs, filters and flaps.
- Repairs or replacements required as a result of unauthorised repairs or inexpert installation that fails to meet the requirements contained in the user guide or instruction book.
- Repairs to products used in commercial or non-residential household premises.

How to obtain after sales service, help or general advice

Please keep your purchase receipt or other proof of purchase in a safe place as you will need to show us this document if your product requires attention within the guarantee period.

Please also record your product details below, which will allow you to access our services more quickly and help us identify your product. The model number is printed on the front of the user guide and the serial and model number is shown on your products rating plate.

| Model number | Serial number | Purchased from | Date of purchase |
|---------------------|----------------------|-----------------------|-------------------------|
| | | | |

Please call our UK based Customer Service department if you need help or advice from us:

United Kingdom and Northern Ireland: **0333 207 9710**

Republic of Ireland: **01 862 3411**

You can also contact us through our website: **www.beko.co.uk**

Arçelik A.Ş.
Karaağaç Caddesi No: 2-6, 34445,
Sütlüce, İstanbul, Türkiye

www.beko.com

Free Manuals Download Website

<http://myh66.com>

<http://usermanuals.us>

<http://www.somanuals.com>

<http://www.4manuals.cc>

<http://www.manual-lib.com>

<http://www.404manual.com>

<http://www.luxmanual.com>

<http://aubethermostatmanual.com>

Golf course search by state

<http://golfingnear.com>

Email search by domain

<http://emailbydomain.com>

Auto manuals search

<http://auto.somanuals.com>

TV manuals search

<http://tv.somanuals.com>