

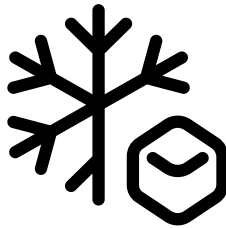

Freezer
User manual



BUFR2715MG - BUFR2715WH - BUFR2715SSIM



EN /

58 4131 0000/AD

Please read this user manual first!

Dear Customer,

We hope that your product, which has been produced in modern plants and checked under the most meticulous quality control procedures, will provide you an effective service.

Therefore, read this entire user manual carefully before using the product and keep it as a reference. If you handover the product to someone else, give the user manual as well.

The user manual will help you use the product in a fast and safe way.

- Read the manual before installing and operating the product.
- Make sure you read the safety instructions.
- Keep the manual in an easily accessible place as you may need it later.
- Read the other documents given with the product.

Remember that this user manual is also applicable for several other models. Differences between models will be identified in the manual.

Explanation of symbols

Throughout this user manual the following symbols are used:

	Important information or useful hints.
	Risk of injury and damage to the property.
	Risk of electric shock.
	Packaging materials of the product are manufactured from recyclable materials in accordance with our National Environment Regulations.

Contents

1 Important instructions for safety and Environment 4

- 1.1 General safety 4
- 1.1.1 HCA warning..... 6
- 1.1.2 For products with a water dispenser 6
- 1.2 Intended use..... 7
- 1.3 Children's safety 7
- 1.4 Compliance with RoHS Directive: 7
- 1.5 Package information..... 7

2 Your appliance 9

3 Installation 10

- 3.1. Appropriate installation location 10
- 3.2. Installing the plastic wedges... 10
- 3.3. Adjusting the feet 11
- 3.4. Electrical connection 11
- 3.5. Door Open Warning 11
- 3.6. Changing the illumination lamp 11
- 3.7. Changing the door opening direction 12
- 3.8. Connecting the water hose to the refrigerator (optional) 12
- 3.9. Connecting the water line to the water supply (optional)..... 12

4 Preliminary preparation 13

- 4.1. What to do for energy saving... 13
- 4.2. First Use 13

5 Operating the product 15

- 5.1 Indicator panel 15
- 5.2 Freezing fresh food 17
- 5.3 Recommendations for preservation of frozen food..... 18
- 5.4 Deep-freeze information..... 18

6 Maintenance and cleaning 19

- 6.1 Avoiding bad odours 19
- 6.2 Protecting the plastic surfaces . 19

7 Troubleshooting 20

1

Important instructions for safety and

Environment

This section contains safety instructions that will help protect from risk of personal injury or property damage. Failure to follow these instructions shall void any warranty.

Intended use

- **WARNING:** Keep ventilation openings, in the appliance enclosure or in the built-in structure, clear of obstruction.
- **WARNING:** Do not use mechanical devices or other means to accelerate the defrosting process, other than those recommended by the manufacturer.
- **WARNING:** Do not damage the refrigerant circuit.

NOTE: This warning is only applicable to appliances with refrigerating circuits which are accessible to the user.

- **WARNING:** Do not use electrical appliances inside the food storage compartments of the appliance, unless they are of the type recommended by the manufacturer.
This appliance is intended to be used in household and similar applications such as
 - staff kitchen areas in shops, offices and other working environments;
 - farm houses and by clients in hotels, motels and other residential type environments;
 - bed and breakfast type environments; catering and similar non-retail applications.

1.1 General safety

- This product can be used by children at and above 8 years old and by persons whose physical, sensory or mental capabilities were not fully developed or who lack experience and knowledge provided that they are supervised or trained on the safe usage of the product and the risks it brings out. Children must not play with the product. Cleaning and maintenance works should not be performed by children unless they are supervised by someone.
- Unplug the product if a failure occurs while it is in use.
- If the product has a failure, it should not be operated unless it is repaired by the Authorized Service Agent. There is the risk of electric shock!
- Connect the product to a grounded outlet protected by a fuse complying with the values in the rating plate. Have the grounding installation made by a qualified electrician. Our company shall not be liable for any damages that will arise when the product is used without grounding in accordance with the local regulations.
- Unplug the product when not in use.

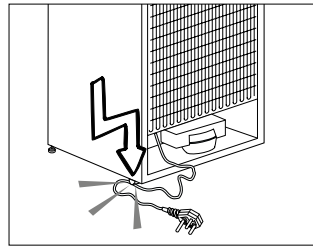

- Never wash the product by spreading or pouring water onto it! There is the risk of electric shock!

Instructions for safety and environment

- Never touch the plug with wet hands! Never unplug by pulling on the cable, always pull out by grabbing the plug.
- It is recommended to clean the tip of the plug regularly with a dry cloth.
- Do not plug the refrigerator if the wall outlet is loose.
- Never connect your freezer to electricity-saving systems. Such systems are harmful for the product.
- Unplug the product during installation, maintenance, cleaning and repairing procedures.
- Always have the installation and repairing procedures carried out by the **Authorized Service Agent**. Manufacturer shall not be held liable for damages that may arise from procedures carried out by unauthorised persons.
- Do not eat cone ice cream and ice cubes immediately after you take them out of the freezer compartment! This may cause frostbite in your mouth!
- Do not touch frozen food by hand! They may stick to your hand!
- Do not put bottled and canned liquid beverages in the freezer compartment. They may burst!
- Never use steam and steam assisted cleaning materials to clean or defrost the freezer. Steam will cause short circuit or electric shock since it would get into contact with the electrical parts in the freezer!
- Do not use mechanical devices or other methods to accelerate the defrosting process, other than those recommended by the manufacturer.
- Never use the parts on your refrigerator such as the door and drawer as a means of support or step. This will cause the product to tip over or parts of it get damaged.
- Do not damage the cooling circuit, where the refrigerant is circulating, with drilling or cutting tools. The refrigerant that might blow out when the gas channels of the evaporator, pipe extensions or surface coatings are punctured may cause skin irritations and eye injuries.
- Do not cover or block the ventilation holes on the refrigerator with any material.
- Place the beverage with higher proofs tightly closed and vertically.
- Do not use gaseous sprays near the product since there is the risk of fire or explosion!
- Flammable items or products that contain flammable gases (e.g. spray) as well as the explosive materials should never be kept in the appliance.
- Do not place containers filled with liquid on top of the product. Spilling water on an electrical component may cause electric shocks or risk of fire.
- Do not store products (vaccines, heat-sensitive medicines, scientific materials and etc.) that require a precise temperature control in the refrigerator.

Instructions for safety and environment



- If you will not operate the product for a long period of time, unplug and unload the food in it.
- If the product is equipped with blue light, do not look at the blue light with optical tools.
- Exposing the product to rain, snow, sun and wind is dangerous with respect to electrical safety.
- In products with mechanical control (thermostat), wait for minimum 5 minutes to plug in the product again after unplugging it.
- Do not overload the product. It may fall when the door is opened, and cause injury or damage. Similar problems may occur in case of putting things on top of the product.
- If the product's door is equipped with a handle, do not pull by the handle when changing the place of the product. Handle may get loose.
- Pay attention not to have your hand or any part of your body get caught by the moving parts inside the product.

1.1.1 HCA warning

- If your product's cooling system contains R600a:
This gas is flammable. Therefore, pay attention to not damaging the cooling system and piping during usage and transportation. In the event of damage, keep your product away from potential fire sources that can cause the product catch a fire and ventilate the room in which the unit is placed.

Ignore this warning if your product's cooling system contains R134a.

Type of gas used in the product is stated in the type plate which is on the left wall inside the refrigerator. Never throw the product in fire for disposal.

	If the product is equipped with a cooling system containing R134a gas, ignore this warning.
	You can learn the gas used in production of your product on the rating plate located on the left inner part of it.
	WARNING: Never dispose the product in fire.

1.1.2 For products with a water dispenser

- Pressure for cold water inlet shall be maximum 90 psi (620 kPa). If your water pressure exceeds 80 psi (550 kPa), use a pressure limiting valve in your mains system. If you do not know how to check your water pressure, ask for the help of a professional plumber.
- If there is risk of water hammer effect in your installation, always use a water hammer prevention equipment in your installation. Consult Professional plumbers if you are not sure that there is no water hammer effect in your installation.

Instructions for safety and environment

- Do not install on the hot water inlet. Take precautions against of the risk of freezing of the hoses. Water temperature operating interval shall be 33°F (0.6°C) minimum and 100°F (38°C) maximum.
- Use only potable water.

1.2 Intended use

- This product has been designed for domestic use. It is not suitable for commercial use and it must not be used out of its intended use.
- Product must be used only for storing food.
- The manufacturer waives any responsibility arisen from incorrect usage or transportation.
- Original spare parts will be provided for 10 years, following the product purchasing date.

1.3 Children's safety

- If the door has a lock, the key should be kept away from reach of children.
- Children must be supervised to prevent them from tampering with the product.



DANGER: Risk of child entrapment. Before you throw away your old refrigerator or freezer:

- Take off the doors.
- Leave the shelves in place so that children may not easily climb inside.

1.4 Compliance with RoHS Directive:

The product you have purchased complies with EU RoHS Directive (2011/65/EU). It does not contain harmful and prohibited materials specified in the Directive.

1.5 Package information

- Packaging materials of the product are manufactured from recyclable materials in accordance with our National Environment Regulations. Do not dispose of the packaging materials together with the domestic or other wastes. Take them to the packaging material collection points designated by the local authorities.
- « Contact qualified personnel for disposal. »
- « Contact qualified personnel for servicing. »



DANGER: Risk Of Fire or Explosion. Flammable Refrigerant Used. Do Not Use Mechanical Devices To Defrost Refrigerator. Do Not Puncture Refrigerant Tubing”.



DANGER: Risk Of Fire Or Explosion. Flammable Refrigerant Used. To Be Repaired Only By Trained Service Personnel. Do Not Puncture Refrigerant Tubing”.

Instructions for safety and environment



CAUTION : Risk Of Fire Or Explosion. Flammable Refrigerant Used. Consult Repair Manual/Owner's Guide Before Attempting To Service This Product. All Safety Precautions Must be Followed.



CAUTION : Risk Of Fire Or Explosion. Dispose Of Properly In Accordance With Federal Or Local Regulations. Flammable Refrigerant Used.



CAUTION : Risk Of Fire Or Explosion Due To Puncture Of Refrigerant Tubing; Follow Handling Instructions Carefully. Flammable Refrigerant Used".



WARNING:

- This product can expose you to chemicals including Nickel (Metallic) which is known to the State of California to cause cancer.
- For more information go to www.P65Warnings.ca.gov
- **NOTE :** Nickel is a component in all stainless steel and some other metal components.

2 Your appliance

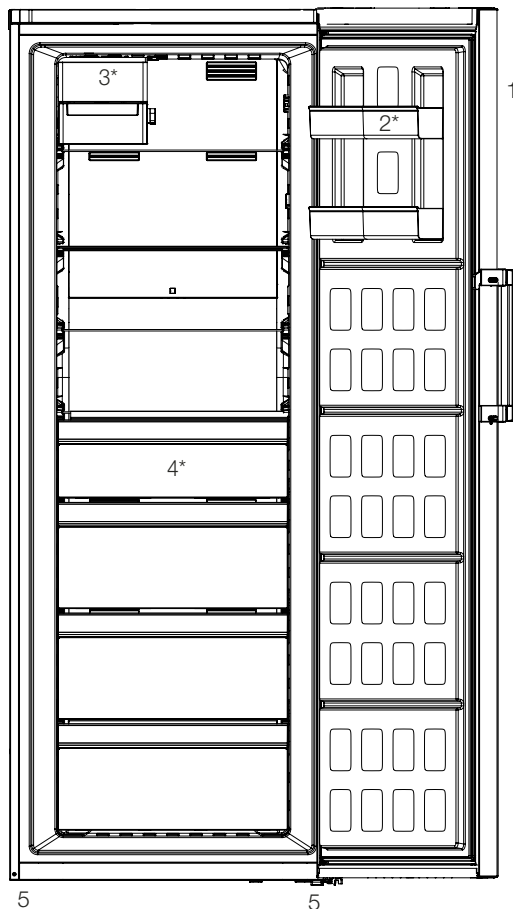

1. Control Panel
2. Door shelf
3. Icebox / Ice-making compartment
4. Drawers
5. Adjustable front feet



*** May not be available in all models**



Figures in this user manual are given as an example and may not match the product exactly. If the relevant parts are not available in the product you purchased, the figure applies to other models.

3.1. Appropriate installation location

Contact an Authorized Service for the installation of the product. In order to prepare the product for use, refer the information in the user manual and ensure that electrical installation and water installation are appropriate. If not, call a qualified electrician and technician to have any necessary arrangements carried out.

	<p>WARNING: Manufacturer shall not be held liable for damages that may arise from procedures carried out by unauthorized persons.</p>
	<p>WARNING: Product must not be plugged in during installation. Otherwise, there is the risk of death or serious injury!</p>
	<p>WARNING: If the door clearance of the room where the product shall be placed is so tight to prevent passing of the product, remove the door of the room and pass the product through the door by turning it to its side; if this does not work, contact the authorized service.</p>

- Place the product on an even floor surface to prevent jolts.
- Install the product at least 30 cm away from heat sources such as hobs, heater cores and stoves and at least 5 cm away from electrical ovens.
- Product must not be subjected to direct sun light and kept in humid places.

- Appropriate air ventilation must be provided around your product in order to achieve an efficient operation. If the product is to be placed in a recess in the wall, pay attention to leave at least 5 cm distance with the ceiling and side walls.
- Do not install the product in places where the temperature falls below 23°F.

3.2. Installing the plastic wedges

Plastic wedges supplied with the product are used to create the distance for the air circulation between the product and the rear wall.

1. To install the wedges, remove the screws on the product and use the screws supplied together with the wedges.
2. Insert the 2 plastic wedges onto the rear ventilation cover as illustrated in the figure.

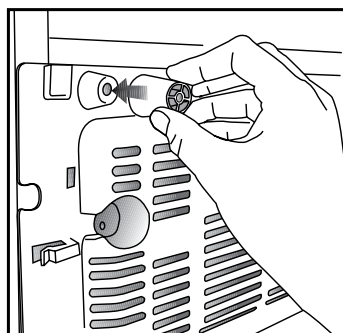

Installation

3.3. Adjusting the feet

If the product stands unbalanced after installation, adjust the feet on the front by rotating them to the right or left.

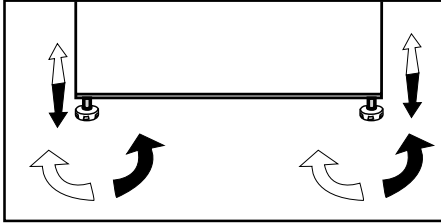

3.4. Electrical connection

	WARNING: Do not make connections via extension cables or multi-plugs.
	WARNING: Damaged power cable must be replaced by the Authorized Service Agent.
	If two coolers are to be installed side by side, there should be at least 4 cm distance between them.

- Our company shall not be liable for any damages that will arise when the product is used without grounding and electrical connection in accordance with the national regulations.
- Power cable plug must be within easy reach after installation.
- Do not extension cords or cordless multiple outlets between your product and the wall outlet.



Hot Surface Warning!
Side walls of your product is equipped with refrigerant pipes to improve the cooling system. Refrigerant with high temperatures may flow through these areas, resulting in hot surfaces on the side walls. This is normal and does not need any servicing. Please pay attention while touching these areas.

3.5. Door Open Warning

***May not be available in all models**

An audio warning signal will be given when the door of your product is left open for at least 1 minute. This warning will be muted when the door is closed or any of the display buttons (if any) are pressed.

3.6. Changing the illumination lamp

To change the Bulb/LED used for illumination of your refrigerator, call your AuthorisedService.

The lamp(s) used in this appliance is not suitable for household room illumination. The intended purpose of this lamp is to assist the user to place foodstuffs in the refrigerator/freezer in a safe and comfortable way.

The lamps used in this appliance have to withstand extreme physical conditions such as temperatures below -4 °F.

(only chest and upright freezer)

Installation

3.7. Changing the door opening direction

Door opening direction of your refrigerator can be changed according to the place you are using it. If this is necessary, please call your nearest Authorized Service.

3.8. Connecting the water hose to the refrigerator (optional)

Connect the water line to a water supply valve. If a valve is not present or you are not sure, consult a qualified plumber.

3.9. Connecting the water line to the water supply (optional)

1. Slip the union (B) onto the water hose (A).
2. Push the water hose downwards firmly to slip it onto the water inlet valve (C).
3. Tighten the union (C) by hand to secure it onto the water inlet valve.
4. Normally, you are not required to tighten the union with a tool. However, you can use a wrench or pliers to tighten the union if there is a leakage.

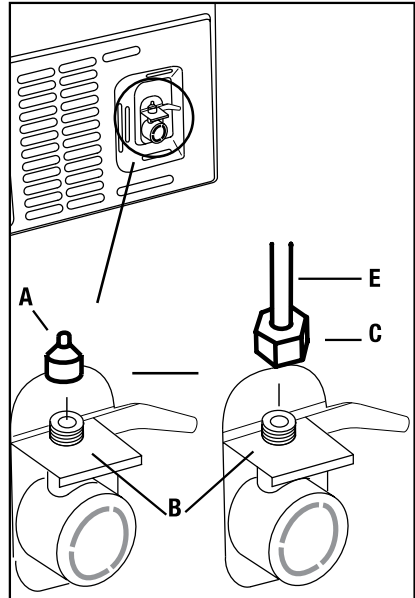

4 Preliminary preparation

4.1. What to do for energy saving



Connecting the product to electronic energy-saving systems is harmful, as it may damage the product.

- For a freestanding appliance; 'this refrigerating appliance is not intended to be used as a built-in appliance.
- Do not keep the freezer doors open for long periods.
- Do not place hot food or beverages into the freezer.
- Do not overfill the freezer; blocking the internal air flow will reduce cooling capacity.
- Food packages should not be in direct contact with the heat sensor located in the freezer compartment. The food should be 10 cm away from the sensor. In case of contact with the sensor, energy consumption of the device may increase.

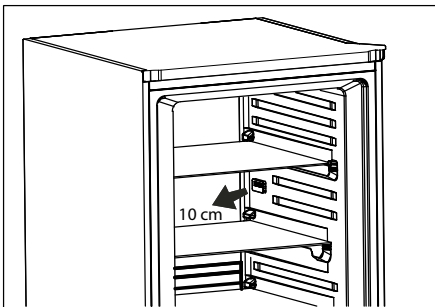

4.2. First Use

Before using your refrigerator, make sure the necessary preparations are made in line with the instructions in "Safety and environment instructions" and "Installation" sections.

- Keep the product running without placing any food inside for 6 hours and do not open the door, unless absolutely necessary.
- The temperature change caused by opening and closing of the door while using the product may normally lead to frost deposit, icing and condensation on food placed on door/body shelves and glass containers placed in the product.



A sound will be heard when the compressor is engaged. It is normal to hear sound even when the compressor is inactive, due to the compressed liquids and gasses in the cooling system.



It is normal for the front edges of the refrigerator to be warm. These areas are designed to warm up in order to prevent condensation.



For some models, indicator panel turns off automatically 1 minutes after the door closes. It will be reactivated when the door is open or any button is pressed.

- Since hot and humid air will not directly penetrate into your product when the doors are not opened,

4 Preliminary preparation

your product will optimize itself in conditions sufficient to protect your food. Functions and components such as compressor, fan, heater, defrost, lighting, display and so on will operate according to the needs to consume minimum energy under these circumstances.

Attention: The freezer creates a vacuum seal - allow minimum 15 seconds for back to back opening of the freezer door.

5 Operating the product

5.1 Indicator panel

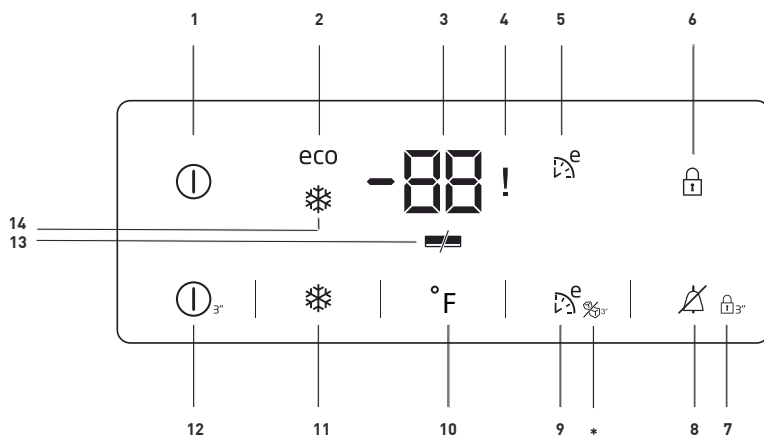

1. On/Off Indicator:

This icon (ⓐ) come on when the freezer is turned off. All the other icons turn off.

2. Economic Usage Indicator:

This icon (eco) (comes on when the Freezer Compartment is set to -18°C (0 °F) which is the most economical set value. Economic Usage Indicator turns off when the Quick Fridge or Quick Freeze function is selected.

3. Freezer Compartment Temperature Setting Indicator:

Indicates the temperature set for the Freezer Compartment.

4. Power failure/High temperature / error warning indicator :

This light (!) illuminates during power failure, high temperature failures and error warnings. During sustained power failures, the highest temperature that the freezer compartment reaches will flash on the digital display.

5. Eco Extra Indicator:

This icon (eco) lights up when this Function is active.

6. Key Lock Indicator:

This icon (🔒) lights up when the Key Lock mode is activated.



***optional:** Figures in this user manual are given as an example and may not match the product exactly. If the relevant parts are not available in the product you purchased, the figure applies to other models.

Operating the product

7.Key Lock Mode:

Press Key Lock () button continuously for 3 seconds. Key lock icon will light up and key lock mode will be activated. Buttons will not function if the Key Lock mode is active. Press Key Lock button continuously for 3 seconds again. Key lock icon will turn off and the key lock mode will be exited.

8- Alarm off warning:

In case of power failure/high temperature alarm, after checking the food located in the freezer compartment press the alarm off button () to clear the warning. High Temperature Alarm may also be cleared by other keys than the Alarm Off key.

9.Eco Extra Function/Ice Cancel Function:(*optional)

Press the Eco Extra button () to activate Eco Extra Function when going on holiday for instance. Freezer will start operating in the most economic mode at around 6 hours later and the economic usage indicator will turn on when the function is active. Refrigerator stops ice production when you press selection button for 3 seconds (for products with ice-maker)

10.Freezer Set Function:

This function (**°F**) allows you to change the Freezer compartment temperature setting. Press this button to set the temperature of the freezer compartment to -0, -2, -4, -6, -8, -10, -12°F, (18, -19, -20, -21, -22, -23 and -24)respectively.

You can set the temperature unit to Centigrade or Fahrenheit by pressing this button for 3 seconds.

11.Quick Freeze Function:

Quick Freeze indicator () turns on when the Quick Freeze function is on. Press Quick Freeze button again to cancel this function. Quick Freeze indicator will turn off and normal settings will be resumed.

Quick Freeze function will be cancelled automatically 52 hours later if you do not cancel it manually. If you want to freeze plenty amount food, press Quick Freeze button before you place the food into the freezer compartment.

12.On/Off Function:

This function () allows you to make the Fridge turn off when pressed for 3 seconds.The fridge could be turned on by pressing On/Off button for 3 seconds again .

13.Energy Saving Indicator :

If the product doors are kept closed for a long time energy saving function is automatically activated and energy saving symbol is illuminated. ()

When energy saving function is activated, all symbols on the display other than energy saving symbol will turn off. When the Energy Saving function is activated, if any button is pressed or the door is opened, energy saving function will be canceled and the symbols on display will return to normal.

Operating the product

Energy saving function is activated during delivery from factory and cannot be canceled.

14. Quick Freeze Indicator :

This icon (❄) comes on when the Quick Freeze function is on.

5.2 Freezing fresh food

- Wrap or cover the food before placing them in .
 - Hot food must cool down to the room temperature before putting them in the refrigerator.
 - The foodstuff that you want to freeze must be fresh and in good quality.
 - Foodstuff must be divided into portions according to the family's daily or meal based consumption needs.
 - Foodstuff must be packaged in an airtight manner to prevent them from drying even if they are going to be kept for a short time.
 - Materials to be used for packagings must be resistant to cold and humidity and they must be airtight. The packaging material of the food must be at a sufficient thickness and durability. Otherwise the food hardened due to freezing may puncture the packaging. It is important for the packaging to be closed securely for safe storage of the food.
 - Frozen food must be used immediately after they are thawed and they should never be re-frozen.
 - Please observe the following instructions to obtain the best results.
1. Activate the fast freezing function by pressing the «Fast Freeze» button 24 hours before loading the food to be frozen.
 2. 24 hours after pressing the button, place your hot food in the first and second shelves of the product.
 3. The fast freezing function will be automatically inactivated after 52 hours.
 4. Do not try to freeze a large quantity of food at a time. Within 24 hours, this product can freeze the maximum food quantity specified as «Freezing Capacity ... kg/24 hours» on its type label. It is not convenient to put more unfrozen/fresh foods than the quantity specified on the label.
 5. When you put unfrozen food in the product, place them in a way that they do not contact with frozen food. A cool-pack may be placed on foods on the 3rd shelf from top to bottom to prevent heating.
 6. Ensure that raw food do not contact with frozen food in the freezer.

Operating the product

Cooler Compartment Settings	Remarks
-20°C / -4°F	This is the default, recommended setting.
-21, -22, -23 or -24°C / -6,-8,-10,-12 °F	These settings are recommended when the ambient temperature is higher than 30°C / 86°F or when you think the refrigerator is not cool enough due to frequent opening and closing of the door.
Fast Freezing	Use when you want to freeze your food in a short time. Recommended for maintaining the quality of meat and fish products.

5.3 Recommendations for preservation of frozen food

- Pre-packed commercially frozen food should be stored in accordance with the frozen food manufacturer's instructions in a frozen food storage compartment.
- To ensure that the high quality supplied by the frozen food manufacturer and the food retailer is maintained, following points should be noted:
 1. Put packages in the freezer as quickly as possible after purchase.
 2. Ensure that contents of the package are labeled and dated.
 3. Do not exceed "Use By", "Best Before" dates on the packaging.

Defrosting

The freezer compartment defrosts automatically.

5.4 Deep-freeze information

Food must be frozen as rapidly as possible when they are put in the freezer in order to keep them in good quality.

It is possible to preserve the food for a long time only at -0°F or lower temperatures.

You can keep the freshness of food for many months (at 0°F or lower temperatures in the deep freeze).

WARNING!

- Foodstuff must be divided into portions according to the family's daily or meal based consumption needs.
- Foodstuff must be packaged in an airtight manner to prevent them from drying even if they are going to be kept for a short time.

Materials necessary for packaging:

- Cold resistant adhesive tape
- Self-adhesive label
- Rubber rings
- Pen

Materials to be used for packaging the foodstuff must be tear-proof and resistant to cold, humidity, dour, oils and acids.

Foodstuff to be frozen should not be allowed to come in contact with the previously frozen items to prevent their partial thawing. Thawed out food must be consumed and must not be frozen again.

Cleaning your refrigerator / freezer at regular intervals will extend the service life of the product.



WARNING:

Unplug the product before cleaning it.

- Never use gasoline, benzene or similar substances for cleaning purposes.
- Never use any sharp and abrasive tools, soap, household cleaners, detergent and wax polish for cleaning.
- For non-No Frost products, water drops and frosting up to a fingerbreadth occur on the rear wall of the Fridge compartment. Do not clean it; never apply oil or similar agents on it.
- Only use slightly damp microfiber cloths to clean the outer surface of the product. Sponges and other types of cleaning cloths may scratch the surface
- Dissolve one teaspoon of bi-carbonate in half litre of water. Soak a cloth with the solution and wrung it thoroughly. Wipe the interior of the refrigerator with this cloth and the dry thoroughly.
- Make sure that no water enters the lamp housing and other electrical items.
- If you will not use the refrigerator for a long period of time, unplug it, remove all food inside, clean it and leave the door ajar.
- Check regularly that the door gaskets are clean. If not, clean them.
- To remove door and body shelves, remove all of its contents.

- Remove the door shelves by pulling them up. After cleaning, slide them from top to bottom to install.
- Never use cleaning agents or water that contain chlorine to clean the outer surfaces and chromium coated parts of the product. Chlorine causes corrosion on such metal surfaces.

6.1 Avoiding bad odours

- Materials that may cause odour are not used in the production of our refrigerators. However, due to inappropriate food preserving conditions and not cleaning the inner surface of the refrigerator as required can bring forth the problem of odour. Pay attention to following to avoid this problem:
- Keeping the refrigerator clean is important. Food residuals, stains, etc. can cause odour. Therefore, clean the refrigerator with bi-carbonate dissolved in water every few months. Never use detergents or soap.
- Keep the food in closed containers. Microorganisms spreading out from uncovered containers can cause unpleasant odours.
- Never keep the food that have passed best before dates and spoiled in the refrigerator.

6.2 Protecting the plastic surfaces

Do not put liquid oils or oil-cooked meals in your refrigerator in unsealed containers as they damage the plastic surfaces of the refrigerator. If oil is spilled or smeared onto the plastic surfaces, clean and rinse the relevant part of the surface at once with warm water.

Please review this list before calling the service. This will save you time and money. This list contains frequently encountered problems that are not results of faulty workmanship or material use. Your product may not have some of the features described here.

The refrigerator is not operating.

- It may not be plugged in properly. >>> Plug in the product properly.
- The fuse of the socket to which your refrigerator is connected or the main fuse may have blown. >>> Check the fuse.

Condensation on the side wall of the fridge compartment (MULTI ZONE, COOL CONTROL and FLEXI ZONE).

- The door may have been opened/closed frequently. >>> Do not open/close the refrigerator door frequently.
- The environment may be too humid. >>> Do not install the refrigerator at locations with a very high level of humidity.
- Foods containing liquid may have been placed into the refrigerator in vessels without covers. >>> Do not place foods containing liquid into the refrigerator in unsealed vessels.
- Door of the refrigerator may have been left ajar. >>> Do not keep the doors of your refrigerator open for a long time.
- The thermostat may have been set to a very cold level. >>> Set the thermostat to an appropriate level.

The compressor is not operating.

- Protective thermal of the compressor will blow out during sudden power failures or plug-out plug-ins as the refrigerant pressure in the cooling system of the refrigerator has not been balanced yet. The refrigerator will start running approximately after 6 minutes. Please call the Authorised Service Provider if the refrigerator does not start at the end of this period.
- The freezer is in defrosting cycle. >>> This is normal for a refrigerator that performs full-automatic defrosting. Defrosting cycle is performed periodically.
- The refrigerator may not be plugged in. >>> Make sure that the plug fits the socket.
- Temperature settings may be incorrect. >>> Select the correct temperature value.
- Possible power failure. >>> The refrigerator will start to operate normally when power restores.

The operation noise increases when the refrigerator is running.

- Operating performance of the refrigerator may vary based on the ambient temperature changes. This is normal and not a fault.

The fridge is running frequently or for a long time.

Troubleshooting

- Your new product may be bigger than the previous one. Larger refrigerators operate for a longer period of time.
- The room temperature may be high. >>> It is normal that the product operates for longer periods in hot environments.
- The refrigerator may have just been plugged in or loaded with food. >>> It takes the product longer to reach the set temperature when it has just been plugged in or loaded with food. This is normal.
- Large amounts of hot food may have been placed into the refrigerator recently. >>> Do not place hot foods into the refrigerator.
- The doors may have been opened frequently or left ajar for a long time. >>> The warm air that enters the refrigerator causes it to operate for a longer period of time. Do not open the doors frequently.
- Freezer or fridge compartment door may have been left ajar. >>> Check if the doors are closed completely.
- The appliance may be set to a very low temperature. >>> Set the refrigerator temperature to a warmer degree and wait until the product reaches this temperature.
- Door seal of the fridge or freezer compartment may be soiled, worn out, broken or not properly seated. >>> Clean or replace the seal. Damaged/broken seal causes the refrigerator to run for a longer period of time to maintain the current temperature.

Fridge temperature is adequate but the freezer temperature is very low.

- The freezer compartment temperature may be set to a very low value. >>> Set the freezer compartment temperature to a higher value and check.

Freezer temperature is adequate but the fridge temperature is very low.

- The fridge temperature is adjusted to a very low value. >>> Adjust the fridge temperature to a higher value and check.

Food kept in the fridge compartment drawers is frozen.

- The fridge compartment temperature may be set to a very high value. >>> Set the fridge compartment temperature to a lower value and check.

Temperature in the fridge or freezer is very high.

- The fridge compartment temperature may be set to a very high value. >>> Fridge compartment temperature setting has an effect on the temperature of the freezer. Change the temperature of the fridge or freezer compartment until the fridge or freezer compartment temperature reaches an adequate level.
- The doors may have been opened frequently or left ajar for a long time. >>> Do not open the doors frequently.
- The door may have been left ajar. >>> Close the door completely.
- The refrigerator may have been just plugged in or loaded with food. >>> This is normal. It takes the product longer to reach the set temperature when it has just been plugged in or loaded with food.
- Large amounts of hot food may have been placed into the refrigerator recently. >>> Do not place hot foods into the refrigerator.

Vibration or noise.

Troubleshooting

- The floor may not be stable or level.
>>> If the refrigerator shakes when moved slightly, adjust the feed to balance it. Make sure that the floor is level and capable of carrying the refrigerator.
- Objects placed onto the refrigerator may cause noise. >>> Remove the objects on the refrigerator.

There are noises coming from the refrigerator like liquid spilling or spraying.

- Liquid and gas flows occur in accordance with the operating principles of the refrigerator.
>>> This is normal and not a fault.

Whistle is heard from the refrigerator.

- There are fans that are used to cool the refrigerator. This is normal and not a fault.

Damp accumulates on the inner walls of refrigerator.

- Hot and humid weather increases icing and condensation. This is normal and not a fault.
- The doors may have been opened frequently or left ajar for a long time. >>> Do not open the doors frequently. Close the doors, if open.
- The door may have been left ajar.
>>> Close the door completely.

Humidity occurs on the outer surface of the refrigerator or between the doors.

- Air might be humid. This is quite normal in humid weathers.
>>> Condensation will disappear when the humidity level decreases.
- There might be external condensation at the section between two doors of the refrigerator if you use your product rarely. This is normal. Condensation will disappear upon frequent use.

There is a bad odour inside the refrigerator.

- No regular cleaning may have been performed. Clean the inside of the refrigerator with a sponge, lukewarm water or carbonated water.
- Some vessels or packaging materials may cause the odour. >>> Use another vessel, or packaging materials from another brand.
- Foods may have been placed into the refrigerator in vessels without covers. >>> Store the foods in closed vessels. Microorganisms emitted from vessels without a cover may cause unpleasant odours.
- Take out expired or spoiled foods from the refrigerator.

The door cannot be closed.

- Food packages may be preventing the door from closing. >>> Relocate the packages that are obstructing the door.
- The refrigerator may be unstable on the floor. >>> Adjust the refrigerator feet as required to keep the refrigerator in balance.
- The floor may not be level or solid.
>>> Make sure that the floor is level and capable of carrying the refrigerator.

Crispers are stuck.

- Foods may be touching the upper wall of the crisper. >>> Re-organise the foods in the crisper.

If The Surface Of The Product Is Hot.

High temperatures may be observed between the two doors, on the side panels and at the rear grill while the product is operating. This is normal and does not require service maintenance!

Fan keeps running when the door is open.

Troubleshooting

The fan may keep running when the door of the freezer is open.



WARNING: If you cannot eliminate the problem although you follow the instructions in this section, consult your dealer or the Authorised Service Provider. Never attempt to repair a malfunctioned product.

WARRANTY STATEMENT FOR THE BEKO REFRIGERATORS

The warranties provided by Beko in these statements only apply to Beko appliance sold to the original purchaser or homeowner in the US (Including Alaska and Hawaii). The warranty is not transferable. To obtain warranty service, please contact your dealer or contact us at www.beko.us/support/. You will need your product model number, serial number, retailer name and address, where purchased and purchase date / installation date. This warranty gives you specific legal rights, and you may also have other rights which vary from state to state. Also, please make sure you register your product for warranty at www.beko.us/product-registration-en/

2 year (*) full warranty from date of first Installation

Beko will repair or replace at no cost to the consumer any defective parts product if used under normal household conditions(warranty is void if the product is used commercially e.g., bed + breakfast, nursing home etc.) Service must also be performed by an authorized Beko service agency. (Cosmetic defects must be reported within 10 business days from installation). 1 year warranty on the accessories is for the parts only and does not include labor.

3rd thru 5th year (*, **) Sealed System Warranty on refrigerators - Parts Only

Beko will provide (No Charge) any compressor, evaporator, condenser and filter Dryer to the consumer if material defects or workmanship have caused the damage or failure of these components.
(Trip and Labor charges are the responsibility of the consumer)

Disclaimers of warranties and exclusions:

Warranty does not cover service costs by an authorized service agent to correct installation, electrical problems or educational instruction on the use of the electric and gas ranges. The warranty also does not cover defects or damage caused by an act of God (such as storms, floods, fires, mudslides, etc.), damage cause by use of the electric and gas ranges for purposes other than those for which it was designed, misuse, abuse, accident, alteration, improper installation, maintenance, travel fees, service calls outside normal service hours, pick up and delivery, any food loss due to product failure, unauthorized service work or work.

This product is fully tested and went through official quality assurance inspections before leaving the original manufacturing site. Warranty terms for this Beko household appliance is not valid if the product is altered, tampered, modified, additional parts assembled, fixed and re-packed by an authorized distributor, servicer, a third party retailer, reseller or by any other unauthorized person(s).

TO THE EXTENT PERMITTED BY LAW, THIS WARRANTY IS IN LIEU OF ALL OTHER EXPRESSED AND IMPLIED WARRANTIES, INCLUDING THE IMPLIED WARRANTIES OF MERCHANTABILITY AND FITNESS FOR A PARTICULAR PURPOSE. BEKO UNDERTAKES NO RESPONSIBILITY FOR THE QUALITY OF THIS PRODUCT EXCEPT AS OTHERWISE PROVIDED IN THIS WARRANTY STATEMENT. BEKO ASSUMES NO RESPONSIBILITY THAT THE PRODUCT WILL BE FIT FOR ANY PARTICULAR PURPOSE FOR WHICH YOU MAY BE BUYING THIS PRODUCT, EXCEPT AS OTHERWISE PROVIDED IN THIS WARRANTY STATEMENT.

Beko does not assume any responsibility for incidental or consequential damages. Such damages include, but are not limited to, loss of profits, loss of savings or revenue, loss of use of the electric and gas ranges or any associated equipment, cost of capital, cost of any substitute equipment, facilities or services, downtime, the claims of third parties, and injury to property. Some states do not allow the exclusion or limitation of incidental or consequential damages, so the above limitations or exclusion may not apply to you.

(*) Installation date shall refer to either purchase date or 5 business days after delivery of the product to the home, whichever is later.

() Parts replaced will assume the identity of the original parts + their original warranty.**

No Other Warranties. This Warranty Statement is the complete and exclusive warranty from the manufacturer. No employee of Beko or any other party is authorized to make any warranty statements in addition to those made in this Warranty Statement.

Please keep this warranty card, user manual and your sales slip for future reference.

HOW TO GET SERVICE

Please contact your local authorized Beko dealer, or call our Toll Free Customer Hotline number at 1-888-352 BEKO (2356) for direction to an Authorized Beko Service Agent or contact via <http://www.beko.us>. You can also look up for authorized dealer list at "Where To Buy" section at the website for further reference.

Free Manuals Download Website

<http://myh66.com>

<http://usermanuals.us>

<http://www.somanuals.com>

<http://www.4manuals.cc>

<http://www.manual-lib.com>

<http://www.404manual.com>

<http://www.luxmanual.com>

<http://aubethermostatmanual.com>

Golf course search by state

<http://golfingnear.com>

Email search by domain

<http://emailbydomain.com>

Auto manuals search

<http://auto.somanuals.com>

TV manuals search

<http://tv.somanuals.com>