

BEKO

*installation & operating
instructions and cooking guidance*

Electric cooker with
oven and grill

Model
D 531

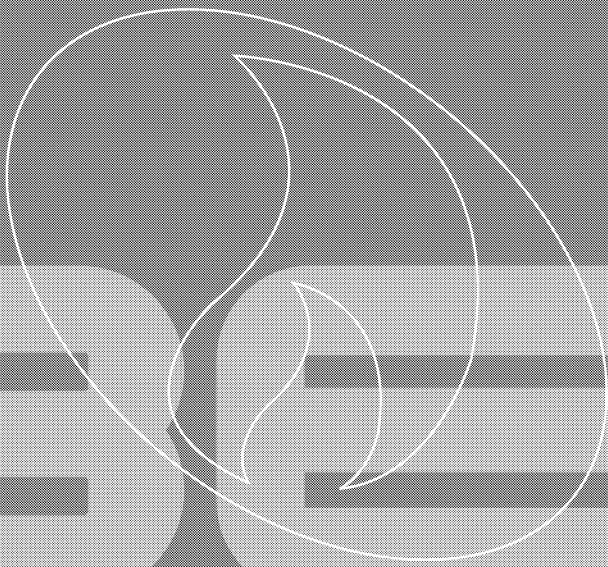

get the **best** from your new cooker

Dear customer

Congratulations on your choice of a Beko quality cooker which has been designed to give you lasting service.

The cooker must be installed by a qualified electrician in accordance with current regulations and used in a well ventilated space.

Please read these instructions thoroughly before installing or using - and keep for handy reference. Make sure you understand the controls prior to using your appliance. This cooker must only be used for its intended purpose, ie the cooking of food in the home. Failure to observe these instructions may invalidate your right to free service during the guarantee period.

If you have any questions, or if you are not sure about any information contained in this booklet please contact us - details are on the back cover.

Your Customer Service

safety symbols

The use of any electrical appliance and cookers in particular (which use high temperatures) require the following of basic common sense safety rules.

There is a danger of injury to the person and of damage to the cooker, the kitchen and your home.

These are itemised in the first section 'Safety in the home'. Where accidents are most common, we repeat these warnings in the main text using the following symbols:



Where you, other people, toddlers and children are at risk



Where there is a danger of damage to the cooker, utensils, surrounding areas and property

Please note them for your own safety.

contents



Introduction

Welcome/Safety symbols	2
Safety in the home	4

Installation

Know your cooker/specification	6
Electrical connection and location	7
Installation	8

For the very first time

Preparation and burning off	8
-----------------------------	---

Operating

Operating the hob	9
Saucepan types/deep fat frying	10
Operating the grill	11
Operating the fan oven	12

Cooker care

Care & cleaning	13
Trouble shooting	14
Future transportation	14
Replacing the oven lamp	14
Guarantee & service	15

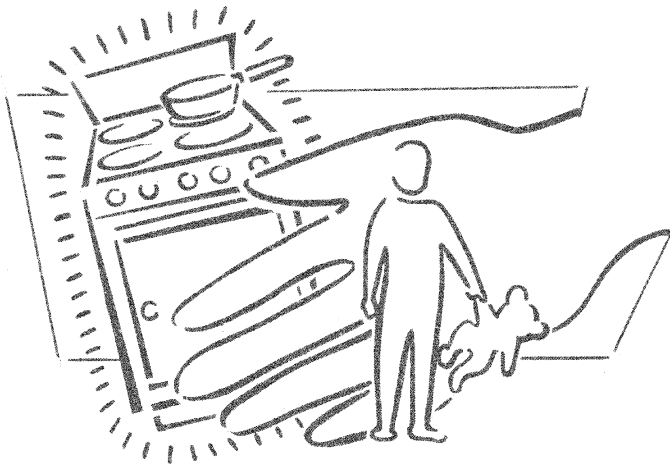

Look after yourself, family and friends

- **Ensure that children are kept away whilst the cooker is in use and until it has cooled as parts become very hot. Don't leave them unsupervised.**
- During use surfaces get hot. Don't touch hot surfaces during use.
- Close supervision while cooking is essential at all times.
- Special care should be taken when cooking oily and fatty food as overheating of such food can cause them to catch fire.
- Always use good quality oven gloves when removing hot utensils and the grill pan from the oven.
- Ensure handles of pans can not accidentally be caught or knocked and do not get heated by adjacent heating zones.
- Check all controls on the appliance are switched off after use.
- Take care when opening the door. Let steam and hot air escape before removing the food.
- Select the correct shelf position before turning the oven or grill on - don't move oven shelves when hot.
- Don't use water to extinguish oil or fat fires.
- Don't heat up unopened food containers as pressure can build up causing the container to burst.
- Don't use round-bottomed traditional woks. Use flat-bottomed types.
- Don't store items above the cooker that children may try to reach.

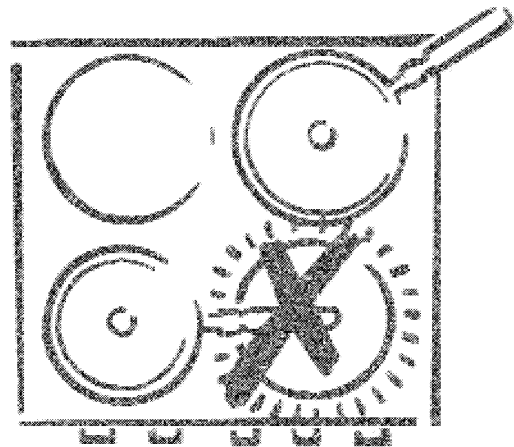

safety in the home



Look after your cooker and home

- Clean your cooker regularly, ideally after each use. Always turn off the mains electricity supply and allow the appliance to cool first.
- Spillage should be dealt with as soon as it occurs, taking due care as the hob surface may be hot. Any spillage left on the surface after cooking should be cleaned off before the hob is switched on again to prevent baking on.
- Don't use biological washing powder or bleach products, harsh abrasives or chemical cleaners for cleaning the oven inner panels.
- Don't allow anyone to sit or stand on the cooker or door.
- Don't move the cooker by pulling by the door and/or handle.
- Ensure that no flammable materials are adjacent to the cooker as the sides become hot during use.
- Don't store flammable materials, aerosols etc in adjacent cabinets.
- Don't place flammable or plastic items on or near the hob, and never place wet cloths etc. on the hob to dry.
- Keep all ventilation slots clear of obstructions.
- Don't leave a hob on for long periods when not covered by a pan.
- Don't cover shelves with metal foil as the air circulation in the oven will be disrupted.
- Don't place dishes, pans, trays directly on the oven compartment base.
- Don't line the grill pan with aluminium foil. As this could result in an increased risk of fire or damage to your cooker.
- Don't use the cooker with glass windows removed.

Don't use the cooker for

- Hanging towels and dish cloths etc on the handles.
- Warming plates under the grill.
- Heating the kitchen.
- Drying.

Food hygiene

- Ensure meat and poultry is thoroughly defrosted before cooking.
- Check food is thoroughly cooked and is piping hot.

- Always refer servicing to a qualified appliance service engineer.



know your cooker

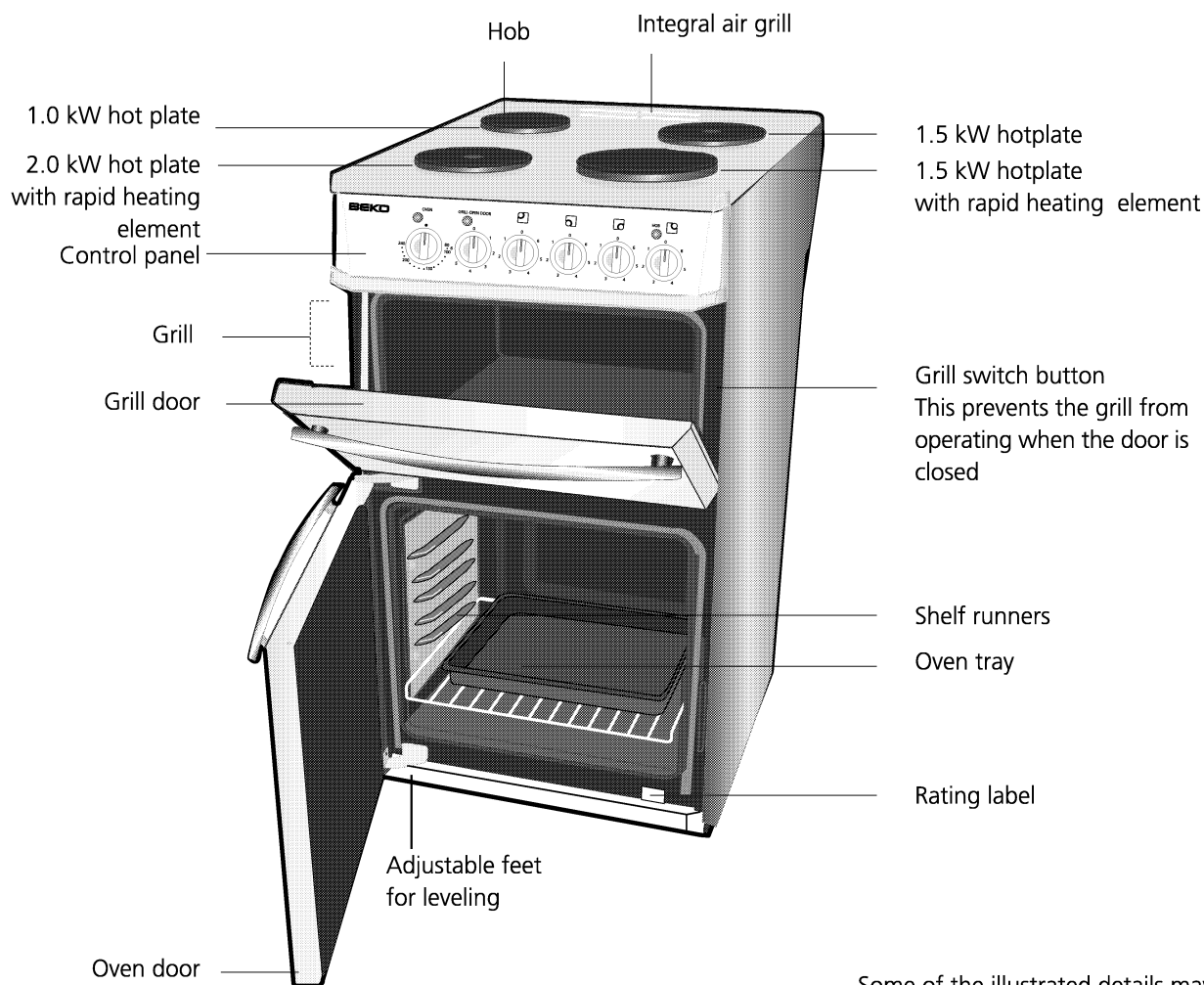

Some of the illustrated details may vary

specification

Supply voltage	230V AC
Supply frequency	50 Hz
Maximum wattage	10.4 W
Adjustable grill wattage	2000 W
Oven wattage	2400 W
Hotplate wattage - Front left	2000 W (*)
Hotplate wattage - Rear left	1000 W
Hotplate wattage - Front right	1500 W (*)
Hotplate wattage - Rear right	1500 W (*)
Unpacked external dimensions	H: 900 mm W: 500 mm D: 600 mm

(*) protector

Packed external dimensions	H: 985 mm W: 560 mm D: 700 mm
----------------------------	-------------------------------------

Because we continually strive to improve our products, we may change our specifications and designs without prior notice.

Accuracy

Note that times and temperatures in this book are for guidance only.

electrical connection

- Do not connect the cooker to the electricity supply until all packing and transit protectors have been removed.
- 1 Before your appliance is connected to the mains electricity supply, check to ensure that the voltage and frequency shown on the rating label corresponds with your power supply. The label is located on the plinth below the oven door.



- 2 **This product must only be installed by a qualified electrician** eg local electricity company or NICEIC registered contractor to a suitable double-pole control unit with a minimum contact clearance of 3mm in all poles and with a minimum rating of 32A which should be fitted adjacent to (but not above) the cooker in accordance with IEE regulations. Failure to observe this instruction may result in operational problems and invalidation of the product warranty.



- 3 Access to the mains terminal is gained by removing the small rear cover. The cable must have conductors of sufficiently high cross sectional area to prevent overheating and deterioration. Recommended cross-section area is six square millimetres (6.00 mm²). The mains cable must conform to BS6004.
- This appliance must be earthed.**
- 4 The mains cable must pass through the cable clamp.
 - 5 The mains cable should be routed away from the appliance and in particular ventilation slots, the vent outlet and should not be obstructed when pushed in to position between the appliance and the wall and/or cabinets.
- The appliance conforms to BS 800: 1988 and EEC directive 87/308 regarding suppression of radio and television interference.
 - Type with regard to protection against overheating of surrounding surfaces=X.

location

- Excess steam from the oven is expelled at the rear of the appliance therefore the wall behind the cooker needs to be protected against grease and moisture.
- The cooker is designed to fit between kitchen cabinets spaced over 500 mm apart. The space either side of the cooker need only be sufficient to allow withdrawal of the cooker for servicing. It can be used with cabinets on one side or both sides as well as in a corner setting. It can also be used free-standing.
- Adjacent side walls above the appliance must not be nearer to the cooker than 150mm and should be of heat resistant material. Leave at least 750 mm clearance above the hob.

To avoid damage to surrounding units a 10mm gap should be left between the appliance and the units. If this is not possible, a kit (part number 01 25552 00) may be ordered from Customer Care which will protect the units.

For models with side opening doors, we recommend a side clearance of 60 mm between the cooker and any side wall to allow the door to be opened fully.

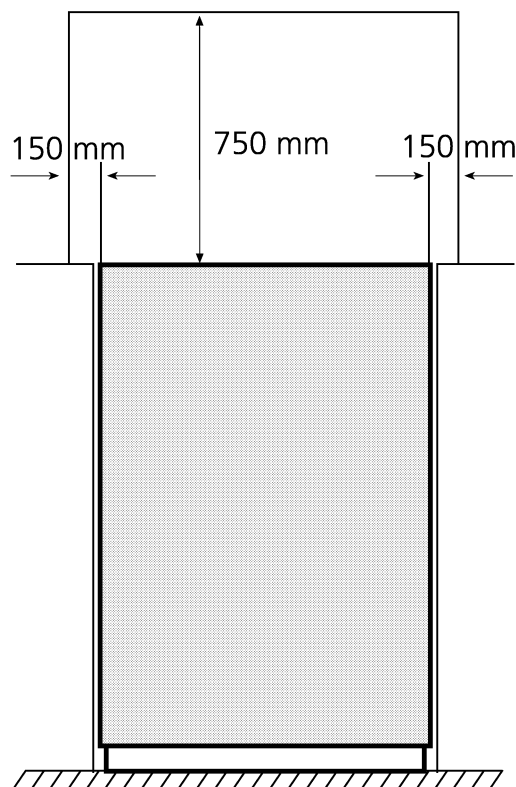

Levelling

The appliance should be located on a level surface. The two front feet can be adjusted as required. To ensure that your appliance is standing level adjust the two front feet by turning clockwise or anticlockwise until the product is in firm contact with the floor.

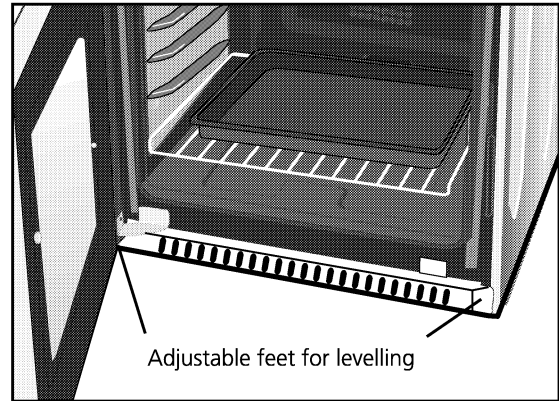

preparation and burning off



Important for asthmatic sufferers

Before using for the first time, protective coatings need to be burnt off. Fumes will be emitted but this is quite normal.

Ensure the room is very well ventilated during the burning off process. Avoid directly inhaling the fumes during this process.

Hotplates

Adjust the hotplates to the mid position and leave on for about 8 minutes. Do not place any pans or other cooking utensil on the hotplates during this process.

Grill

Open the grill door. Remove wire rack, baking tray and handle, and set the control to the mid position for about 15 minutes.

oven

Remove shelves and baking tray and turn the oven control knob to 200°C for about 15 minutes.

Cleaning

Before you start using your cooker, clean the appliance as recommended under Care and cleaning on page 13.

operating the hob

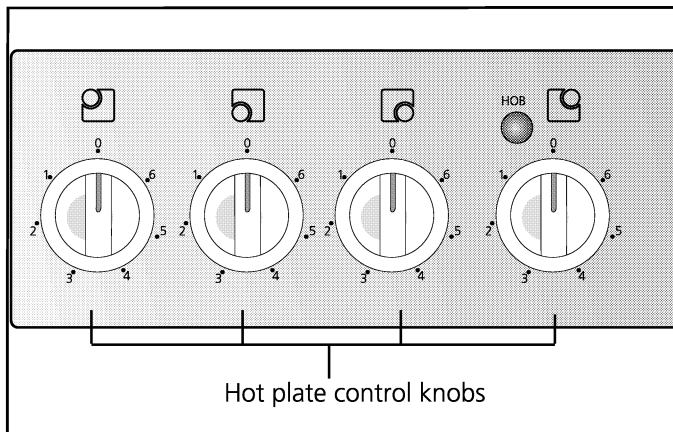

- 1 Rotate the control knobs in either direction to provide fully variable heat control.
 - 2 When any one of the hotplates is on, the red indicator light on the control panel is on.
 - 3 To switch a hotplate off turn the corresponding knob to 0 (zero).
- Rapid heating hotplates are at the front and are denoted by a red spot in the centre of each hotplate. (The red spot will wear with time - this is not a fault and operation is not affected.)

Knob position	Use
1	Warming
2-3	Simmering
4-5-6	Cooking-Frying-Boiling



Before retiring for the evening it is advisable to check that all the cooker controls have been switched off.

For best simmering results, we recommend you use the rear left hotplate.

Over heat protection

The thermal protector reduces the power, if excessive heat is detected during abnormal operating conditions.

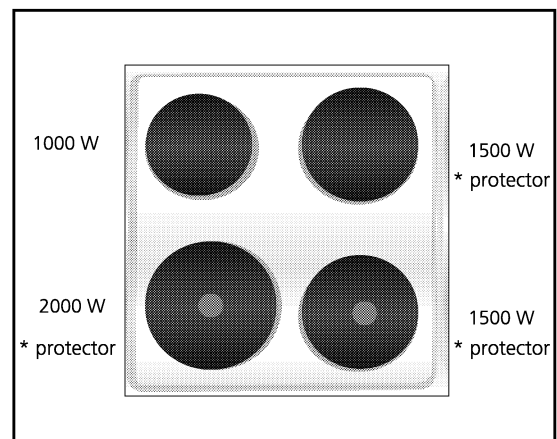

saucepan type

For best results we recommend the use of good quality saucepans with smooth flat bases. This gives the maximum use of the energy in the hotplate.

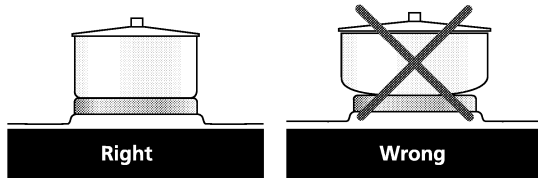

Aluminium pans with coloured vitreous enamelled bases absorb heat and are therefore more efficient in use.

Never use recessed or ridged base saucepans.

Use pans of the correct diameter. The base should be about the same size as the hotplate. Suggested sizes are 6" (15cm) for the small hotplates, 7" (18cm) for the large hotplates. If the pan is too small energy is wasted.

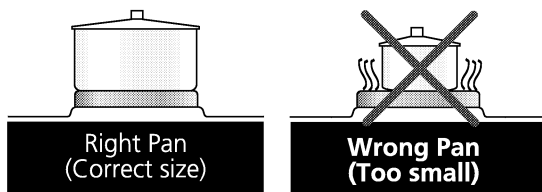

Use pans which have sufficient capacity for the amount of food being cooked so they don't boil over and cause unnecessary cleaning.

Place only dry pans on the hotplate. Do not place lids, particularly wet ones, on the hotplates.

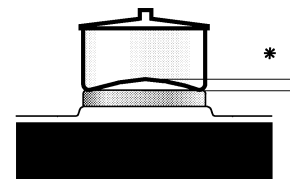
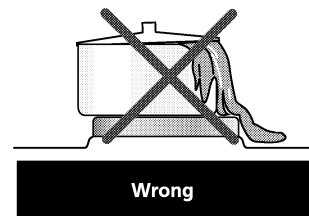

Diameter of pot bottom	* Max. concavity in cold condition	* Max. concavity in hot condition
145 mm	0.9 mm	0.5 mm
180 mm	1.1 mm	0.6 mm

Pressure cookers

Only use pressure cookers suitable for solid hotplates.

deep fat frying



- Never fill the pan more than one-third full of fat or oil.
- Never leave unattended during heating or cooking.
- Do not fry too much food at the same time especially frozen food. This only lowers the temperature of the oil or fat too much resulting in greasy food.
- Always dry food thoroughly before frying and lower it slowly into the hot oil or fat. Frozen foods in particular will cause frothing and spitting if added too quickly.
- Never heat fat or fry with a lid on the pan.
- Keep the outside of the pan clean and free from streaks of oil or fat.

In the event of a chip pan or other pan fire

- 1 Switch off the electricity supply.
- 2 Smother flames with a fire blanket or damp cloth.

Burns and injuries are caused almost invariably by picking up the burning pan and rushing outside with it.

Do not use water on the fire.

Leave the pan to cool for at least 30 minutes.



operating the grill



Parts may become hot when the grill is in use, children must be kept away.



As a safety feature, a switch prevents the grill from working when the door is closed.

It will only work when the door is fully open.

- When the door is fully open, it remains tilted slightly, so that any spillage will be directed away from you.

1 Open the grill door.

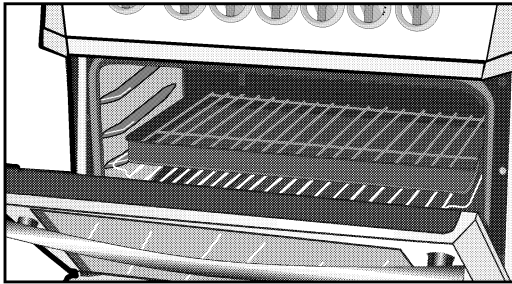

2 Turn the grill on by turning the grill control knob to position 6 and allow to preheat for around 5 minutes.

3 The red indicator light will glow to show that the grill has been switched on.

4 Then choose the desired setting.

- **Only use the middle and bottom rack position for grilling. Do not use the top position.**
- Ensure the food is correctly positioned under the grill element.
- Food which requires browning only should be placed under the hot grill, either in the grill pan, or on the floor of the grill compartment, according to the depth of the dish. The grill pan wire grid can be removed.
- Do not line the grill pan with aluminium foil.
- Plates and dishes placed on the floor of the grill compartment will be heated when the main oven is in use.
- Do not switch on the grill when using the compartment for storage.

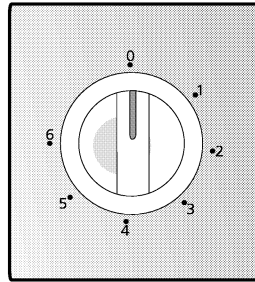

Grilling guidelines

Use setting 6 for toast, for sealing and fast cooking of foods.

For thicker foods requiring longer cooking, turn the control to a lower setting after the initial sealing on both sides. The thicker the food, the lower the control should be set. When grilling thicker food, the grill rack should be turned over to its lowest position.

Use of grill pan handle



Warning! Always use an oven glove to protect your hand when using the grill as all metal parts can become every hot.

The grill pan has a detachable handle. Make sure the handle is securely located between the raised profiles across the front of the grill pan. See the diagrams for fitting the handle. To remove the handle, reverse the sequence of operations.

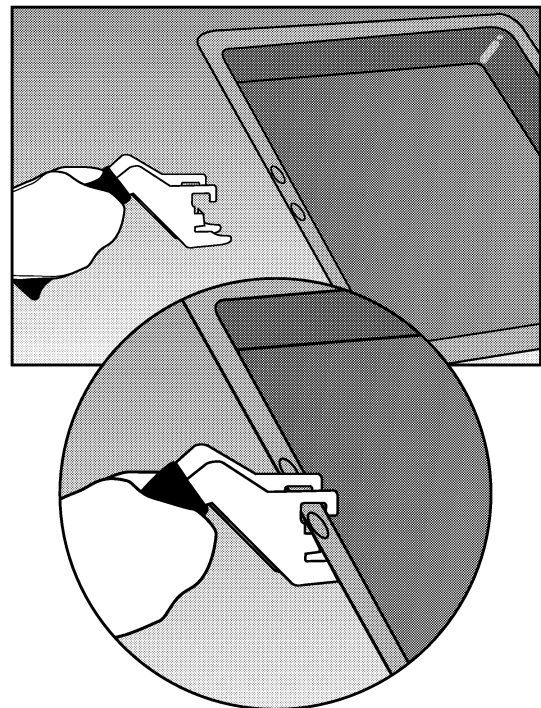

Always take care not to touch hot surfaces when using the grill pan handle. Ensure when using the grill pan handle that it is centralised and secure. Do not leave the handle in position when grilling. If the handle is left in position when grilling, it will get very hot.

operating the oven

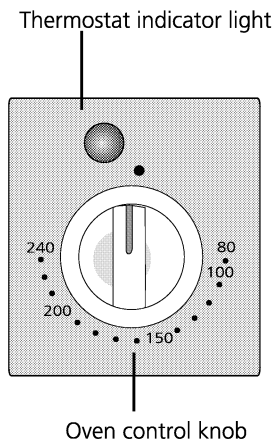

- 1 Turn the oven on by rotating the oven control knob clockwise.
- 2 Select the temperature in the oven by selecting the temperature (in degrees Celsius) printed on the control panel.
- 3 The amber temperature indicator light on the control panel will glow until the pre-set temperature is reached.
- 4 Once the temperature has been reached, the amber light will go off and then cycle on and off to maintain the pre-set temperature.



The oven uses the outer top element and a concealed bottom element.

Ensure you stand back from the appliance when opening the oven door to allow any build up of steam or heat to escape.

- Check food is thoroughly cooked and is piping hot.
- 5 To turn the oven off turn the control knob anti-clockwise to the ● mark.

Temperature conversion

The oven temperature control knob is marked in degrees Celsius (sometimes called Centigrade). This chart will help when recipes show °F or use descriptive terms (as recommended by the Association of Manufacturers of Domestic Electrical Appliances).

Description	Celsius °C	Fahrenheit °F
Cool	80	175
	100	200
	110	225
Slow	120	250
	140	275
	150	300
Fairly hot	160	325
	180	350
Hot	190	375
	200	400
Very hot	220	425

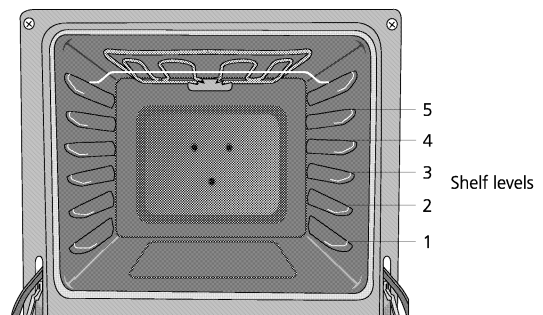

Oven temperature chart

This chart is for guidance only, follow food manufacturers recommendations whenever available.

Food	Cooking temperature °C	Time	Shelf position
Beef	180-200	25-30 mins per 450g +30 mins	1
Lamb	180-200	25-30 mins per 450g + 30 mins	1
Pork	180-200	30-35 mins per 450g + 25 mins	1
Poultry	180-200	25-30 mins per 450g + 25 mins	1
Casseroles	140-160	1.5-2 hours dependent on quantity	2
Fruit cake	140-160	Time dependent on size	1-2
Small cakes	160-180	20-25 mins	3
Victoria sandwich	160-180	20-25 mins	2

care & cleaning



Turn OFF at the mains before cleaning.

- Before switching on again ensure that all controls are in the OFF position.
- **Make sure that the oven, grill and hotplates are sufficiently cool before you start cleaning.**
- As the hotplates are of a solid type, a residual heat will remain after you switch off the cooker so take care not to touch hot surfaces.

Exterior

Use a damp cloth to clean the outside. Never use any sharp instruments, abrasive household cleaner, or detergents for cleaning. For hard stains use suitable washing liquid.

Stainless steel surfaces

It is recommended that only branded stainless steel cleaning materials are employed to clean stainless steel surfaces.

Do not use abrasive household cleaning agents, scouring pads, scraper knives or indulit liquid detergents otherwise damage will occur to the surface appearance.

Vitreous enamel hob surround

Clean with a cloth wrung out in soapy water. Stubborn stains can be removed with a cream, paste or liquid cleaner. Check that the cleaning agent used is approved by the Vitreous Enamel Development Council.

Hotplates

The cleaning of sealed hotplates should be done when they are cold.

- 1 Wipe the hotplates with a little domestic non-scratch cleaning cream following the circular

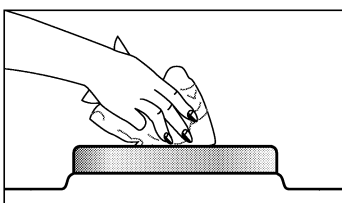

- grooved pattern on the hotplate.
- 2 Wipe over with a damp clean cloth, making sure that all the cleaner has been removed.

- 3 Dry by switching on for a few minutes.
- 4 Apply a thin coat of cooking oil from time to time to provide a protective coating.

Control panel

Wipe over the control panel with a damp cloth and polish with a dry cloth. Do not use oven cleaners or aerosols, scouring pads or abrasive powder for cleaning the plastic knobs or end caps as damage will occur. Do not attempt to remove any of the control knobs from the panel as this may cause damage and is a safety hazard.

Grill interior

Wipe the grill elements with a damp cloth (ensuring they are sufficiently cool first) to remove any fat splashes. This will prevent fumes from any fat being burned off when the cooker is next used.

Oven interior

Remove the rod shelves for washing in the sink. Use a fine steel wool soap pad for removing stubborn stains from

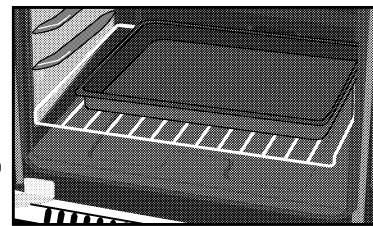

the rod shelves and floor of the oven. Take care during cleaning not to damage, bend or dislodge from the surrounding clips the thermostat sensor which is located at the top right hand side of the oven.

Grill and Oven doors

Wipe over the door outer panels with a cloth wrung out in hot soapy water, then after wiping with a cloth wrung out in clean water, dry with a soft clean cloth. Do not use scouring pads or abrasive powder which may scratch the surface. Take care during cleaning not to damage or distort the door seal. Ensure that the door seal is dry after cleaning. Do not lift the door seal.

Over time...

- Slight discolouration of liners and other surfaces may occur in time. This does not affect the functioning of the appliance.
- The metal rings around the hotplates discolour when in use due to the heat. This is normal, is not a fault and operation of hotplates is not affected.

trouble shooting

If the cooker does not work

If the appliance does not operate check whether:

- The power supply is on.
- The fuse has blown/circuit breaker has tripped/main distribution switch has been turned off.
- The control has been set correctly.
- If the appliance is still not operating after the above checks, please refer to the section on how to obtain service.

Please ensure that the above checks have been made as a charge will be made if no fault is found.

Performance characteristics when in use

- **When using your appliance for the first few times, an odour and/or**

smoke may be emitted which is normal - see page 8.

- It is normal for the metal parts to produce noise when in use, this is due to expansion and contraction.
- When in use, steam may be produced which is normal and not a fault of the cooker.
- At the end of a cooking session, it is normal to have a momentary puff of steam when the oven door is opened. This should disperse in a few seconds.
- If, whilst cooking, steam produced comes in to contact with cool surface's on the outside of the appliance, it will condense and produce water droplets. This is quite normal and is not a fault.

future transportation

Keep the original carton and other packaging material in a safe place. Transport the cooker in its original carton. Follow the instructions that are printed on the carton.

To prevent the accessories inside the oven from damaging the oven door, tape a strip of cardboard onto the inside of the oven door that lines up with the position of the trays. Tape the oven door to the side walls.

If you do not have the original carton

Take the necessary precautions in order to prevent the exterior panels, and the glass surfaces of the oven from being damaged.

Pack the oven in bubble wrap or thick cardboard and tape it securely in order to prevent damage during transportation.

The oven must be transported upright. Do not place other items on the top of the cooker.

Recycling

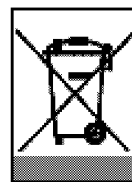

This product bears the selective sorting symbol for waste electrical and electronic equipment (WEEE). This means that this product must be handled pursuant to European Directive 2002/96/EC in order to

be recycled or dismantled to minimize its impact on the environment.

For further information, please contact your local or regional authorities.

Electronic products not included in the selective sorting process are potentially dangerous for the environment and human health due to the presence of hazardous substances.

replacing the oven lamp

Ensure that the appliance is switched off at the mains supply before replacing the lamp to avoid the possibility of electric shock.

- 1 Switch off at the mains.
- 2 Remove the protective glass cover of the lamp inside your oven by turning it anti-clockwise.
- 3 Remove the bulb by turning it anti-clockwise.
- 4 After installing the correct replacement bulb, reinstall the protective glass of the lamp.

Replacement light bulb can easily be obtained from a good local electrical or DIY store.

guarantee

Your Beko product is guaranteed against the cost of breakdown repairs for twelve months from the date of the original purchase.

What is covered?

- All repairs necessary as a result of faulty materials, defective components or manufacturing defect.
- The cost of all functional replacement parts.
- The labour costs of a Beko approved repairer to carry out the repair.

What is not covered?

- Transit or delivery damage
 - Accidental damage
 - Misuse, or abuse.
 - Cabinet or appearance parts, including knobs and flaps
 - Accessory items, including ice trays, scrapers, cutlery baskets,
 - Repairs required as a result of unauthorised repairs or inexpert installation that fails to meet the requirements contained in the user instruction book.
- Repairs to products used on commercial or non-residential household premises.

Important notes.

- The product is guaranteed for domestic household use only.
- The guarantee will be void if the product is installed or used in commercial or non-residential household premises.
- The product must be correctly installed, located and operated in accordance with the instructions contained in the User Instructions Booklet provided.
- Professional Installation by a qualified plumber/electrical appliance installer is recommended for all Washing & Dishwashing Machines and Electric Cookers
- Gas Cookers must only be installed by a CORGI (or BORD GAIS) registered Gas Installer.
- The guarantee is given only within the boundaries of the United Kingdom.
- The guarantee is not transferable if the product is resold.
- Beko plc disclaims any liability for incidental or consequential damages.
- The guarantee does not in anyway diminish your statutory or legal rights.

HOW TO OBTAIN SERVICE UNDER THE MANUFACTURERS GUARANTEE

Please keep your purchase receipt or other proof of purchase in a safe place; you will need to have it should the product require attention in the guarantee period

You should also complete the details below; it will help us assist you quicker when requesting service. (The model number is printed on the Instruction Booklet)

Model Number: _____ Purchased From: _____ Date of purchase: _____

For service under guarantee simply telephone the appropriate number below

LOCATION

TELEPHONE

UK Mainland & Northern Ireland

Fridges & Freezers	0870 241 0638
Electric Cookers	0870 241 1320
Gas & Dual Fuel Cookers	0870 241 1321
Washing Machines & Dishwashers	0870 241 0357

Republic of Ireland

All Refrigeration, Cooking, Washing & Dishwashing Machines	01 862 3411
--	-------------

Before requesting service please check the trouble-shooting guide in the Operating Instructions as a charge may be levied where no fault is found even though your product may still be under guarantee.

Service once the manufacturers guarantee has expired.

If you have purchased an extended guarantee please refer to the instructions contained within the extended guarantee agreement document. Otherwise please call the above numbers where service can be obtained at a charge.

Should you experience any difficulty in obtaining service please call the

Beko Customer Help-Line on 0870 774 1050

Beko House, Caxton Way, Watford, Herts, WD18 8UG, Tel: 0870 774 1050

BEKO

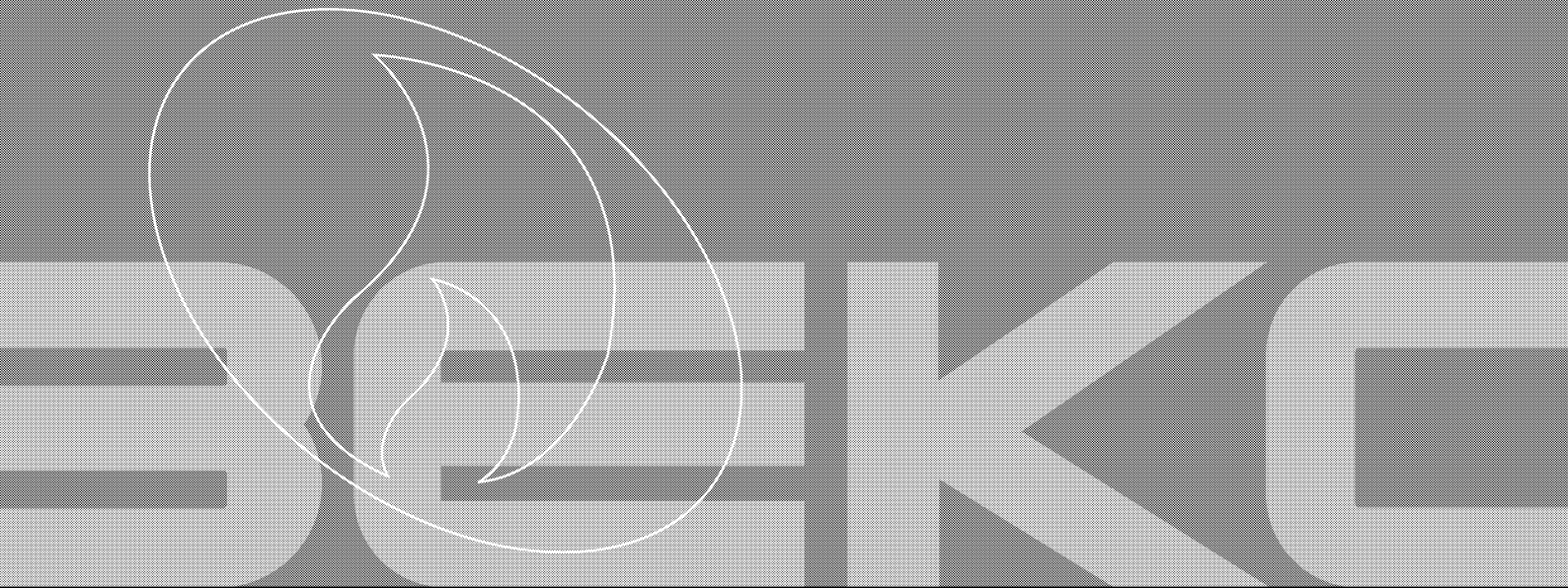

Beko plc
Beko House
Caxton Way
Watford
Herts WD1 8UF
Tel: 01923 818121

Printed in Turkey

Part no.485.9204.97

Free Manuals Download Website

<http://myh66.com>

<http://usermanuals.us>

<http://www.somanuals.com>

<http://www.4manuals.cc>

<http://www.manual-lib.com>

<http://www.404manual.com>

<http://www.luxmanual.com>

<http://aubethermostatmanual.com>

Golf course search by state

<http://golfingnear.com>

Email search by domain

<http://emailbydomain.com>

Auto manuals search

<http://auto.somanuals.com>

TV manuals search

<http://tv.somanuals.com>