

Dishwasher

User's Manual



DEN59420DX

EN

Document Number : 1592670100_AA_BEKO_E8P_EN/06-08-18.(17:14)

beko

Dishwasher

User's Manual

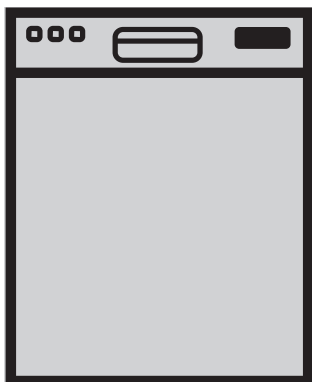

DEN59420DX

EN

Please read these instructions first before using your appliance

Thank you for choosing a Beko appliance.

Please take some time to read this user manual before using your appliance, to ensure you know how to safely operate the controls and functions.

Carefully follow all unpacking and installation instructions to ensure the appliance is correctly connected and fitted prior to use.

Please write your product model and serial number on the last page of this user manual, and store in a safe location close to the appliance for easy future reference.

This user manual may also be applicable for several other models. Differences between models will be listed.

If you have any questions or concerns, please call our contact centre or find help and information online at www.beko.co.uk

Explanation of symbols

Throughout this User Manual the following symbols are used:

	Important information or useful hints about usage.
	Warning for hazardous situations with regard to life and property.
	Warning for electric shock.
	Packaging materials of the product are manufactured from recyclable materials in accordance with our National Environment Regulations.

Do not dispose of the packaging materials together with the domestic or other wastes. Take them to the packaging material collection points designated by the local authorities.



This product was manufactured using the latest technology in environmentally friendly conditions.

Please read these instructions first before using your appliance

Thank you for choosing a Beko appliance.

Please take some time to read this user manual before using your appliance, to ensure you know how to safely operate the controls and functions.

Carefully follow all unpacking and installation instructions to ensure the appliance is correctly connected and fitted prior to use.

Please write your product model and serial number on the last page of this user manual, and store in a safe location close to the appliance for easy future reference.

This user manual may also be applicable for several other models. Differences between models will be listed.

If you have any questions or concerns, please call our contact centre or find help and information online at www.beko.co.uk

Explanation of symbols

Throughout this User Manual the following symbols are used:

	Important information or useful hints about usage.
	Warning for hazardous situations with regard to life and property.
	Warning for electric shock.
	Packaging materials of the product are manufactured from recyclable materials in accordance with our National Environment Regulations.

Do not dispose of the packaging materials together with the domestic or other wastes. Take them to the packaging material collection points designated by the local authorities.

CONTENTS

1 INSTRUCTIONS FOR SAFETY AND ENVIRONMENT 4

General safety	4
Intended use	4
Children's safety	5
Disposing of packaging material	5
Transportation of the product	5
Compliance with WEEE Directive and Disposing of the Waste Product	6
Compliance with RoHS Directive	6
Package information	6

2 DISHWASHER 7

Overview	7
Fan drying system	8
Technical specifications	8

3 INSTALLATION 9

Appropriate installation location	9
Connecting water supply	9
Connection to the drain	10
Adjusting the feet	10
Electrical connection	10
This appliance must be earthed	11
Fitting a different plug	11
Initial use	11

4 PREPARATION 12

Tips for energy saving	12
Water softening system	12
Adjusting the water softening system	12
Adding salt	14
Detergent	15
Adding Liquid/Gel Detergent and Rinse Aid	16
Powder Detergents	17
Tablet detergents	18
Collapsible upper basket wires	21
Tray Wash Supports	21
Upper basket multipurpose service rack	22
Upper basket height adjustable rack	22
Cutlery basket	23
Collapsible lower basket tines	23

Adjusting the height of the upper basket	24
--	----

5 OPERATING THE PRODUCT 25

Programme Selection / Programme	
Cancel key	26
Function Keys	26
Preparing the machine	26
Programme selection	26
Auxiliary functions	29
Scheduling the washing time	31
Starting the programme	32
Cancelling the programme	32
Adjusting the amount of rinse aid... ..	33
Salt indicator (S)	33
Rinse Aid indicator (*)	33
End of programme	33
Water cut-off warning	33
Overflowing warning	34

6 HOMEWHIZ FUNCTION 35

HomeWhiz Setup and User Account Settings	35
--	----

7 MAINTENANCE AND CLEANING 39

Cleaning the outer surface of the product	39
Cleaning the interior of the machine	39
Cleaning the filters	39
Cleaning the hose filter	40
Cleaning the impellers	41
Lower impeller	41
Upper impeller	41

8 TROUBLESHOOTING 42

9 GUARANTEE 47

1 Instructions for safety and environment

This section contains safety instructions that will help to give protection from risk of personal injury or property damage. Failure to follow these instructions shall void all warranties.

General safety

- Never place the product on a carpet-covered floor; otherwise, lack of airflow beneath the product will cause electrical parts to overheat. This will cause problems with your product.
- Do not operate the product if the power cable / plug is damaged! Call the Authorised Service Agent.
- Connect the product to a grounded outlet protected by a fuse complying with the values in the "Technical specifications" table. Do not neglect to have the grounding installation made by a qualified electrician. Our company shall not be liable for any damages that will arise when the product is used without grounding in accordance with the local regulations.
- The water supply and draining hoses must be securely fastened and remain undamaged.
- Unplug the product when not in use.
- Never wash the product by spreading or pouring water onto it! There is the risk of electric shock!
- Never touch the plug with wet hands! Never unplug by pulling on the cable, always pull out by grabbing the plug.
- The product must be unplugged during installation, maintenance, cleaning and repairing procedures.
- Always have the repair procedures carried out by the Authorised Service Agent. Manufacturer shall not be held liable for damages that may arise from procedures carried out by unauthorised persons.
- Never use chemical solvents in the product. They bring forth the risk of explosion.
- When you pull the upper and lower baskets out completely, the door of the product will bear all the weight of the baskets. Do not put other loads on the door; otherwise, the product may tilt.
- Never leave the door of the product open apart from loading and unloading procedures.
- Do not to open the door of the product when it is running unless necessary. Be careful for the rush of hot steam when you need to open the door.

Intended use

- This product has been designed for domestic use.
- It must be used to do the domestic type dishes only.

- This appliance is intended to be used in household and similar applications such as:
 - Staff kitchen areas in shops, offices and other working environments.
- Only dishwasher safe detergents, rinse aids and additives must be used.
- The manufacturer waives any responsibility arisen from incorrect usage or transportation.
- This appliance can be used by children aged from 8 years and above and persons with reduced physical, sensory or mental capabilities or lack of experience and knowledge if they have been given supervision or instruction concerning use of the appliance in a safe way and understand the hazards involved. Children shall not play with the appliance. Cleaning and user maintenance shall not be made by children without supervision.

Children's safety

- Electrical products are dangerous for the children. Keep children away from the product when it is in use. Do not let them to tamper with the product.
- Do not forget to close the door of the product when leaving the room where it is located.

- Store all detergents and additives in a safe place away from the reach of the children.

Disposing of packaging material

Packaging materials are dangerous to children. Keep packaging materials in a safe place away from reach of the children.

Packaging materials of the product are manufactured from recyclable materials. Dispose of them properly and sort in accordance with recycled waste instructions. Do not dispose of them with normal domestic waste.

Transportation of the product



If you need to move the product, do it in upright position and hold from the rear side. Tilting the product onto its front side may cause the electronic parts in it get wet and damaged.

1. Unplug the product before transporting it.
2. Remove water drainage and water supply connections.
3. Drain the remaining water in the product completely.

Compliance with WEEE Directive and Disposing of the Waste Product



This product complies with EU WEEE Directive (2012/19/EU). This product bears a classification symbol for waste electrical and electronic equipment (WEEE). This product has been manufactured with high quality parts and materials which can be reused and are suitable for recycling. Do not dispose of the waste product with normal domestic and other wastes at the end of its service life. Take it to the collection center for the recycling of electrical and electronic equipment. Please consult your local authorities to learn about these collection centers.

Compliance with RoHS Directive

The product you have purchased complies with EU RoHS Directive (2011/65/EU). It does not contain harmful and prohibited materials specified in the Directive.

Package information

Packaging materials of the product are manufactured from recyclable materials in accordance with our National Environment Regulations. Do not dispose of the packaging materials together with the domestic or other wastes. Take them to the packaging material collection points designated by the local authorities.

2 Dishwasher

Overview

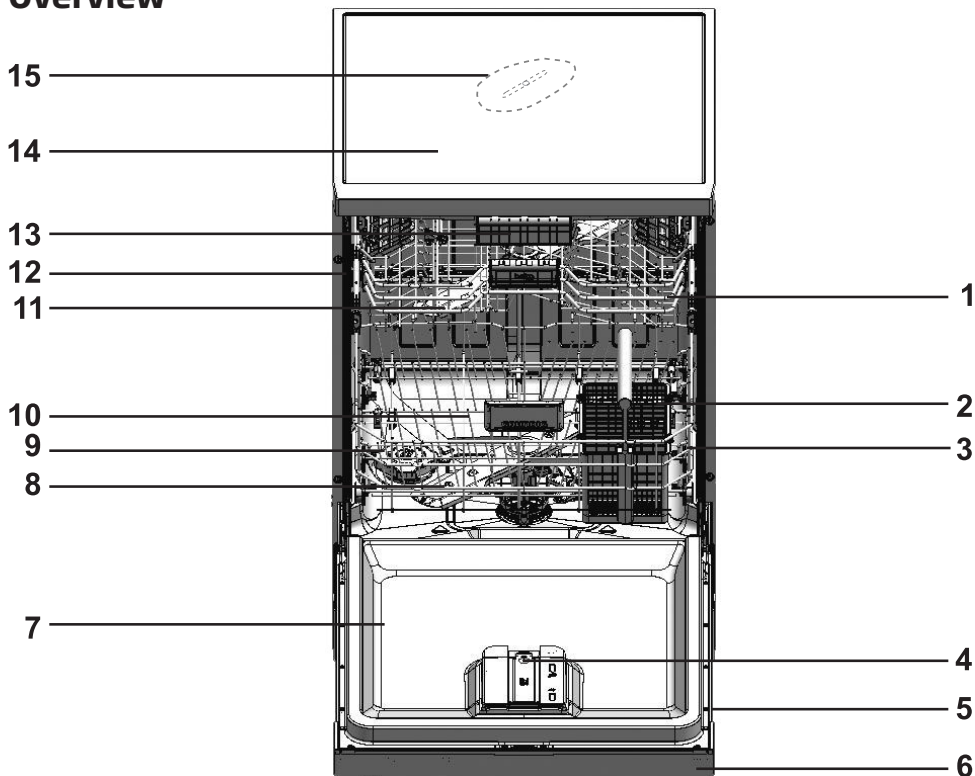

1. Upper basket
2. Cutlery basket
3. Lower basket
4. Automatic Liquid/Gel Detergent and Rinse Aid Dosing System
5. Type Label
6. Control panel
7. Door
11. Lower impeller
9. Salt reservoir lid
10. Filters
11. Upper impeller
12. Upper basket rail
13. Upper cutlery basket (depends on model)
14. Upper table (depends on model)
15. Ceiling impeller (depends on model)
16. Fan drying system (depends on model)

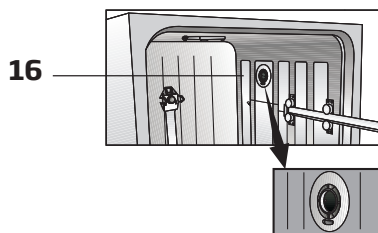

Technical specifications

CE Compliance to standards and test data / EC declaration of conformity

This product complies with the following EU directives;
Development, production and sales stages of this product comply with the safety rules included in all pertaining European Community regulations.

2014/35/EU, 2014/30/EU, 93/68/EC, IEC 60436/DIN 44990, EN 50242

Power input	220-240 V, 50 Hz (see rating label)
Total power consumption	1800-2100 W (see rating label)
Heater power consumption	1800 W (see rating label)
Total current (depends on the model)	10 A (see rating label)
Drain pump power consumption	30 W (see rating label)
Water pressure	0.3 -10 bar (= 3 - 100 N/cm ² = 0.01-1.0 Mpa)



Technical specifications may be changed without prior notice to improve the quality of the product.



Figures in this manual are schematic and may not match the product exactly.



Values stated on the markings of the product or in the printed documents accompanying the product are obtained in the laboratory on basis of the relevant standards. Depending on operational and environmental conditions of the product, these values may vary.

Fan drying system

Fan drying system ensures efficient drying of your dishes.

It is normal to hear a different sound than that of washing cycle during fan operation.

Note for test institutions:

Data required for performance tests shall be provided upon request. Requests can be e-mailed to the following address:

dishwasher@standardloading.com

Do not forget to provide the code, stock and serial numbers of the product to be tested in your request e-mail along with your contact information. Code, stock and serial numbers of the product may be found on the type label attached to the side wall of the door.

3 Installation

To make the product ready for use, make sure that the electricity, tap water supply and water drainage systems are appropriate before calling the Authorised Service Agent. If they are not, call a qualified technician and plumber to have any necessary arrangements carried out.



Preparation of the location and electrical, tap water and waste water installations at the place of installation is under customer's responsibility.



Manufacturer shall not be held responsible for damages arising from processes carried out by unauthorised persons.



Prior to installation, visually check if the product has any defects on it. If so, do not have it installed. Damaged products cause risks for your safety.



Make sure that the water inlet and discharge hoses are not folded, pinched or crushed while pushing the product into its place after installation or cleaning procedures.

When placing the product, pay attention not to damage the floor, walls, piping, etc. Do not hold the product from its door or panel to move it.

Appropriate installation location

- Place the product on a solid and flat floor that has sufficient load carrying capacity! The product must be installed on a flat surface in order for the door to be closed comfortably and securely.

- Do not install the product at places where temperature may fall below 0°C.
- Place the product on a rigid floor. Do not place it on a long pile rug or similar surfaces.



Ensure the power cable does not get trapped under the product.

- Make sure that you select a location that will allow you to load and unload the dishes in a fast and comfortable manner.
- Install the product in a place close to the tap and the drain. Select the installation location by considering that it will not be changed after the connections are made.

Connecting water supply

- Do not use old or used water inlet hose on the new product. Use the new water inlet hose supplied with the product.
- Connect the water inlet hose directly to the cold water tap. Permitted water temperature up to 25°C. Pressure coming from the tap should be minimum 0.3 and maximum 10 bars. If the water pressure exceeds 10 bars, a pressure relief valve should be installed in between.
- Open the tap completely after making the connections to check for water leaks.



For your safety, close the water inlet tap completely after the washing programme is over.

Connection to the drain

Water discharge hose can directly be connected to the drain hole or sink's drainage. The length of this connection must be min. 50 cm and max. 100 cm from the floor. A discharge hose longer than 4 meters will cause washing performance to be affected. Attach the water discharge hose to the drainpipe without bending it. Tightly fix the water discharge hose to the drainpipe in order to prevent any dislocation of the water discharge hose during operation of the product.

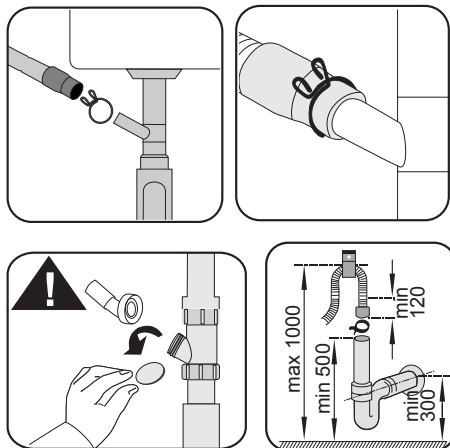

Drainpipe must be connected to the foul water system and it should not be connected to any surface water drain.

Adjusting the feet

If the door of the product cannot be closed properly or if the product wobbles when you push it slightly, then you need to adjust the feet of the product. Adjust the feet of the product as illustrated in the relevant section.



Diswashers door must be aligned properly otherwise hot steam can escape! Danger of serious burns, other injury or may damage furniture.

Electrical connection

Before you insert the plug into the wall socket make sure that the voltage and the frequency shown in the rating label corresponds to your electricity supply.

We recommend that this appliance be connected to the mains supply via a suitable switched and fused socket in a readily accessible position.

If the supply cord or the mains lead is damaged please do not replace it yourself. The supply cord or the mains lead must be replaced by a Authorised Service Agent or a similarly qualified person.



This appliance must be earthed

If the fitted moulded plug is not suitable for your socket, then the plug should be cut off and an appropriate plug fitted. Destroy the old plug, which is cut off as a plug with a bared cord could cause a shock hazard if inserted into a socket elsewhere in the house. The moulded plug on this appliance incorporates a 13A fuse. Should the fuse need to be replaced an ASTA approved BS1362 fuse of the same rating must be used. Do not forget to refit the fuse cover. In the event of losing the fuse cover, the plug must not be used until a replacement fuse cover has been fitted. Colour of the replacement fuse cover must be the same colour as that visible on the pin face of the plug. Fuse covers are available from any good electrical store.

Fitting a different plug

As the colours of the wires in the mains lead of this appliance may not correspond with the coloured markings identifying the terminals on your plug, proceed as follows:

1. Connect the green - yellow or green (earth) wire to the terminal in the plug marked 'E' or with the symbol  or coloured green and yellow or green.
2. Connect the blue (neutral) wire to the terminal in the plug marked 'N' or coloured black.
3. Connect the brown (live) wire to the terminal in the plug marked 'L' or coloured red.

Green and yellow or green

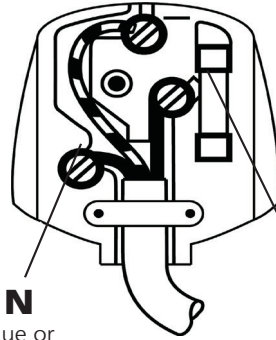

N
Blue or black

L
Brown or red

With the alternative plugs a 13A fuse must be fitted either in the plug or adaptor or in the main fuse box. If in doubt contact a qualified electrician.

Initial use

Before starting to use the product, make sure that all preparations are made in accordance with the instructions in sections "Important safety instructions" and "Installation".

- Before using the product, fill the salt reservoir with 1 litre of water, add salt (see next page) and stir to dissolve. Run the Dishwasher without dishes on a short programme with a small amount of detergent.



There might be a small amount of water left in the product after factory quality control tests. This causes no harm to the product.

4 Preparation

Tips for energy saving

Following information will help you use the product in an ecological and energy-efficient manner.

Wipe away any coarse food remnants on the dishes before putting them in the product.

Operate the product after filling it completely.

When selecting a programme, consider the table of "Programme data and average consumption values".

Do not put more detergent than suggested on the detergent package.

Water softening system

The product is equipped with a water softening system which reduces the hardness of incoming water. This system softens the supply water to a level that will allow washing the dishes with the required quality.

Dishwasher salt is used for this purpose.

Adjusting the water softening system

Cleaning, rinsing and drying performance of your dishwasher will increase when water softening system is adjusted properly.

Adjust the new water hardness level according to the Water hardness level instruction in this booklet.

Use the test strip supplied with the product according to the steps given below to determine hardness level of your supply water.

Preparation

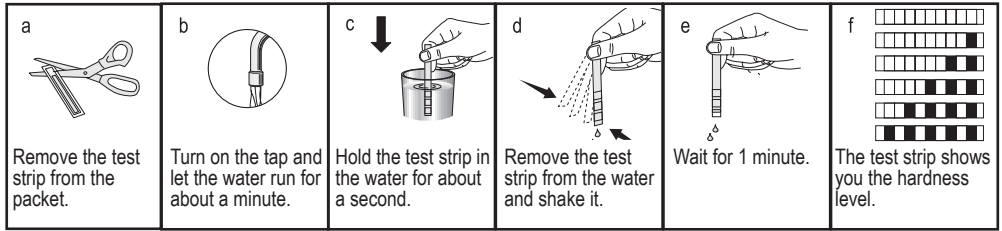

After determining hardness level of the supply water:

1. After switching on your machine, long press the Menu key
2. Press the settings menu key for 3 seconds to enter the Settings Menu.
3. Using <- and > keys, proceed until the water hardness setting indicator becomes on ("r" position will be displayed).
4. Using the Selection key, adjust water hardness level according to the hardness of the supply water. For correct setting please see "Water hardness level setting table".
5. Press the Menu key to exit the settings menu. Your setting will be saved automatically.

Water hardness level adjustment table

Hardness Level	English Water Hardness °dE	German Water Hardness °dH	French Water Hardness °dF	Water Hardness Level Indicator
Level 0 	0-5	0-4	0-8	Press the Selection key to switch the water hardness level to position 1. (r1)
Level 1 	6-9	5-7	9-13	
Level 2 	10-15	8-12	14-22	Press the Selection key to switch the water hardness level to position 2. (r2)
Level 3 	16-19	13-15	23-27	Press the Selection key to switch the water hardness level to position 3. (r3)
Level 4 	20-24	16-19	28-34	Press the Selection key to switch the water hardness level to position 4. (r4)
Level 5 	25-62	20-50	35-90	Press the Selection key to switch the water hardness level to position 5. (r5)

In order to protect your glassware against glass corrosion in an optimal way, you have to perform the same hardness settings, which you have made in the control panel, with the regeneration setting switch.

For example, if you have adjusted to "3rd level" in the control panel, also set the regeneration adjustment switch to 3rd level.

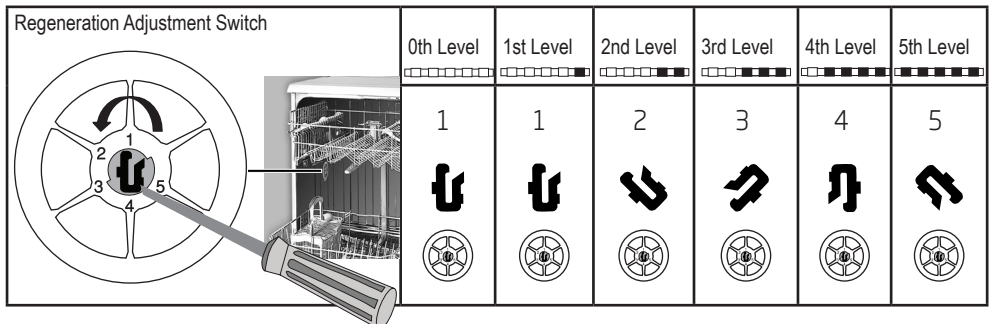

Preparation

If the hardness level of the supply water is above 90 °dF or if you are using well water, then it is recommended to use water purification devices and special filters. If the hardness level of the supply water is below 13°dF, there is no need to use salt in your dishwasher. If this is the case, "No Salt Warning Indicator" (if any) illuminates continuously on the panel of your machine. If the water hardness level adjustment is set to level 1, the "No salt warning indicator" will illuminate continuously although it is not necessary to use salt. If you use salt under this condition, salt will not be consumed and the Salt indicator will not illuminate.



If you move your house, it is necessary to readjust water hardness level of your machine by considering the information given above according to the hardness level of the supply water in your new location. Your machine will display the most recently adjusted water hardness level.



Adjust the water softness level according to the "Water hardness level instruction" supplied with your machine.

Adding salt



Use only special softening salts produced particularly for the dishwashers in your machine.

1. First take the lower basket out to add softening salt.
2. Turn the salt reservoir lid counter-clockwise to open it (A).

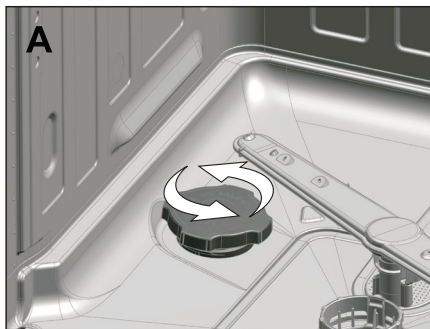

3. Add 1 litre of water to salt reservoir of your machine only in initial use.
4. Add salt to the salt compartment. To speed up dissolution rate of salt in water, stir it with a spoon.



You can put about 2 kg of softening salt into the salt reservoir.

5. Replace the lid and tighten it when the reservoir is full.



You need to add salt right before starting the machine. Thus, the overflowing salty water will be flushed immediately, preventing the risk of corrosion in machine. In cases where you would not start washing immediately, run your machine empty in the shortest program.



Since different salt brands in the market have different particle sizes and since the water hardness may vary, dissolution of the salt in water may take a couple of hours. Therefore, Salt Indicator remains on for a while after adding salt into the machine.

Detergent

You can use powder, tablet and liquid/gel detergent in the machine.



Only use the detergents produced particularly for use with dishwashers in the machine. We recommend you not to use detergents that contain chlorine and phosphate as they are harmful for the environment.

Your dishwasher is equipped with an Automatic Liquid/Gel Detergent Dosing System.

Thanks to this system, the amount of rinse aid and liquid/gel detergent required for the selected washing programme is adjusted automatically.



Please read the information given in section "Operating the Product" to activate or deactivate the Automatic Liquid/Gel Detergent Dosing adjustment.



When the Automatic Liquid/Gel Detergent function is enabled, the Automatic Liquid/Gel Detergent indicator on the panel will light up if there is liquid/gel detergent in the detergent box. If there is little or no detergent in the detergent box, the indicator will flash.



When the Automatic Liquid/Gel Detergent indicator starts to flash, there is enough detergent for at least 5 washing cycles.

- Factory settings of the Automatic Liquid/Gel Detergent Dosing System are based on the detergent

amount recommended by detergent manufacturers.

- You can proceed to the Settings menu to change the Automatic Liquid/Gel Detergent Dosing setting according to your habits, or according to the recommendations by the detergent manufacturer if you are using a different liquid/gel detergent.



Please follow the instructions given in section "Operating the Product" to change the settings of the Automatic Liquid/Gel Detergent Dosing System and Rinse Aid.



In addition to liquid/gel detergents that function only as a detergent, there are also liquid/gel detergents that act as rinse aid and/or soften water. Follow the manufacturer's recommendations when using these detergents.

Detergent manufacturer's recommendations about the amount of liquid/gel detergent to be used are as follows:

For lightly soiled dishes	20 ml
For moderately soiled dishes	25 ml
For heavily soiled dishes	30 ml



Some gel-type detergents may not be suitable for automatic dosing as they are highly viscous. Apply this type of detergents onto the inner surface of the dishwasher's door or directly into the dishwasher, paying attention to the recommendations of the detergent manufacturer.

Adding Liquid/Gel Detergent and Rinse Aid

The Automatic Liquid/Gel Detergent Dosing system is found on the door of your dishwasher.



After fully opening the door of the dishwasher, open the decorative cover as shown with arrows 1 and

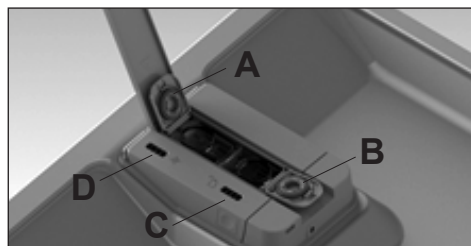

2. Open the cover shown with (A) in the picture and add rinse aid. Open the cover shown with (B), add liquid/gel detergent and close the covers.



The indicator marked with (C) on your machine informs you about the liquid/gel detergent level in the box.



The indicator marked with (D) on your machine informs you about the rinse aid level in the box.



Wipe clean any spilled rinse aid outside the reservoir. Otherwise, it will cause foaming in the next washing cycle, reducing the washing performance of the product.



The rinse aid used in dishwashers is a special product that is recommended to increase drying efficiency and prevent water or lime stains on the washed items. For this reason, care must be paid to have rinse aid in the rinse aid reservoir and to use rinse aids produced specially for dishwashers only.

Using the Automatic Liquid/Gel Detergent Dosing System

In order to use the Automatic Liquid/Gel Detergent Dosing function, select Automatic Liquid/Gel Detergent Dosing function on the control panel.

When the function is active, its indicator comes lit and the system uses appropriate amount of detergent and rinse aid in each washing program.



Press the key again to cancel the function.



When automatic liquid/gel detergent dosing function is selected, do not use other types (powder, tablet, etc) of detergents.

If you want to use another type of detergent while the automatic liquid/gel detergent dosing system is full, cancel the automatic liquid/gel detergent dosing function on

Preparation

the control panel. Then you can use powder, tablet or liquid/gel detergent.



Use only liquid/gel detergent suitable for the dishwasher.



Do not mix different brands of liquid/gel detergents.



Do not fill the liquid/gel detergent box with liquids or chemical cleaners (vinegar, bleach etc.) other than liquid/gel detergent.



Liquid/gel detergents that lost their fluidity and became firm must not be used in automatic liquid/gel detergent dosing system.

Liquid/gel detergents must be used in a short time once they have been unpacked. Unpacked liquid/gel detergents may lose their fluidity in time.



If a different brand or type of liquid/gel detergent will be used, make sure previous detergent is depleted completely and then remove and clean the liquid/gel detergent tank under tap water.



Fill the rinse air box only with rinse aid, and the detergent box only with liquid/gel detergent. If you fill it inappropriately, immediately remove the boxes, empty them and clean under running water.

Installing/Removing the Liquid/Gel Detergent and Rinse Aid Box

To remove the rinse aid and detergent boxes, push and lift the system cover on both sides as shown with arrows 1 and 2 and open.

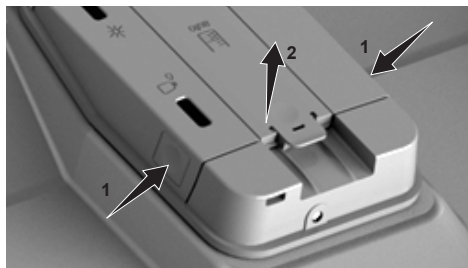

Lift and remove the rinse aid box (A).

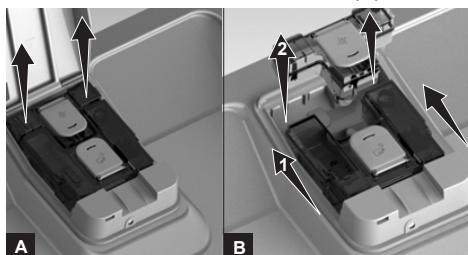

Move the detergent box (B) in the direction of the arrow (1) and lift to remove (2). Once the cleaning or filling procedure is complete, follow the above steps in reverse order to re-install the detergent and rinse aid boxes.

Powder Detergents



You can find the correct amount of powder detergent for the selected programme in the table "Programme Data and Consumption Values".



You can apply powder detergent onto the cover of the dishwasher or directly into the machine.



To use powder detergents, go to the Settings menu to disable the Automatic Liquid/Gel Detergent Dosing System and if any, the Tablet Detergent function.



Powder detergents must be used with programmes without Prewash. See Programme Data and Consumption Values.



Use powder detergent in short programmes without prewash since the solubility of the tablet detergent changes depending on the temperature and time.

Tablet detergents

Tablet detergents exhibit water softening and / or rinse aid effect in addition to detergent effect. Some types of these detergents also contain special-purpose washing chemicals such as glass and stainless steel protectors.



Tablet detergents give satisfying results only under certain usage conditions. The best washing performance in dishwashers is obtained by using detergent, rinse aid and water softening salt individually.

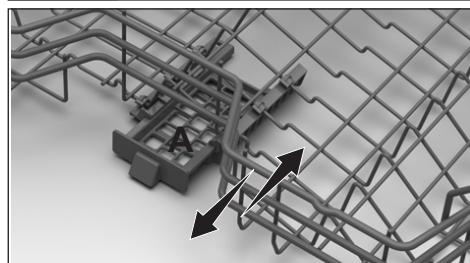

Place the tablet detergent into the Tablet Detergent Box found on the upper basket of the dishwasher (A).



When using tablet detergents, you can use the Tablet Detergent Function to improve the drying performance of the dishwasher (based on model).

Tablet detergent types commonly found on the market:

2in1: Contains detergent, rinse aid or water softening salt

3in1: Contains detergent, rinse aid and water softening salt

4in1: Contains glass protectors in addition to detergent, rinse aid and water softening salt

5in1: Contains glass and stainless steel protectors in addition to detergent, rinse aid and water softening salt



When using tablet detergents, follow the manufacturer's instructions on the packaging.



Contact the detergent manufacturer if your dishes are wet and/or if you notice limescale spots particularly on your glasses after the washing programme is over when using a tablet detergent.

When you switch to powder detergent from tablet detergent:

1. Make sure that salt and rinse aid reservoirs are full.
2. Set the water hardness to the highest level and perform an empty run.
3. After the empty washing cycle, review the user manual and readjust the water hardness level so as to suit the water supply.

4. Make the appropriate rinse aid settings.

Items not suitable for washing in the dishwasher

- Never wash dishes soiled by cigarette ash, candle remnants, polish, dyestuff, chemicals, etc. in your dishwasher.
- Do not wash silverware and cutlery with wooden or bone stems, glued pieces, or pieces that are not resistant to heat, as well as copper and tin-plated containers in the dishwasher.



Decorative prints of chinaware as well as aluminum and silver items may get discoloured or tarnished after washing in the dishwasher just as it happens in handwashing as well. Some delicate glass types and crystals may become dull in time. We strongly recommend you to check if the tableware you are going to purchase is suitable for washing especially in the dishwasher.

the dishwasher. Thus, accumulation of water in deep hollows is prevented.



To prevent possible injuries, always place the sharp and pointed dishes such as service fork, bread knife, etc. upside down so as their pointed ends will face down or they will lie horizontally in the dish basket.

Unload dishes in the lower basket first and then the dishes in the upper basket.

Placing the dishes into the dishwasher

You can use your dishwasher in the optimum way with respect to energy consumption and washing and drying performance only if you place the dishes in an orderly way.

- Wipe away any coarse food remnants (bones, seeds, etc.) on the dishes before placing them in the dishwasher.
- Place thin, narrow pieces in the middle sections of baskets if possible.
- Place the heavily soiled and bigger items in the lower basket and smaller, delicate and light items in the upper basket.
- Place the hollowed dishes such as bowls, glasses and pans upside down in

Preparation

Suggestions for loading the dishwasher

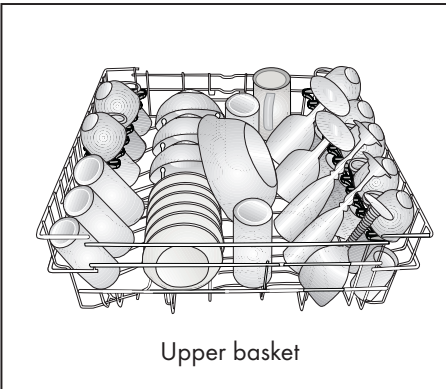
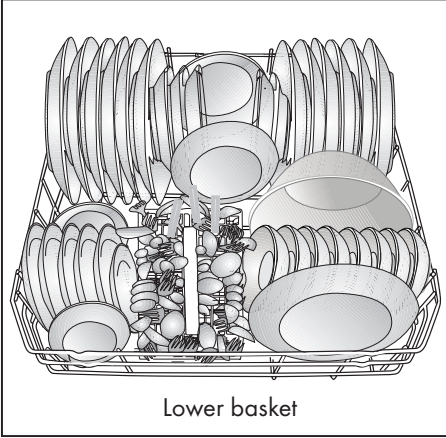

Improper Loading Of Dishware

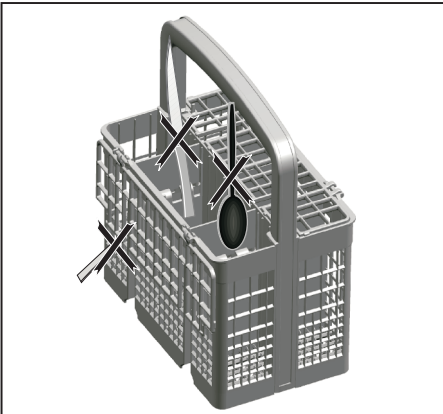

Improper Loading Of Dishware

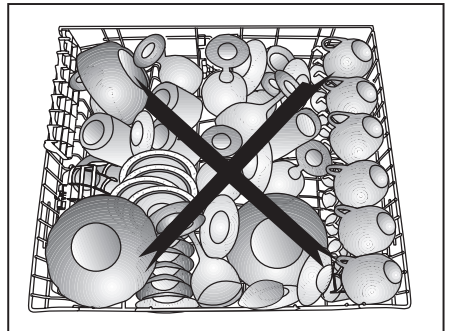
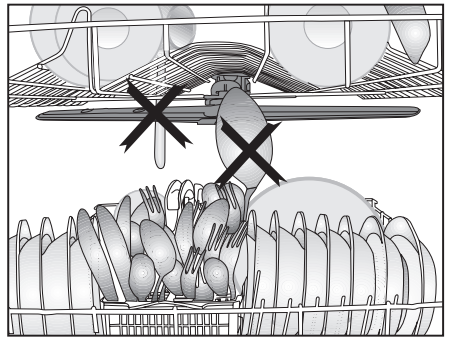
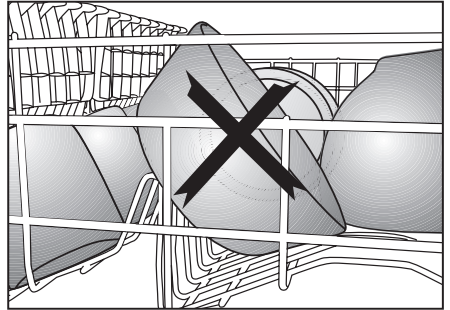
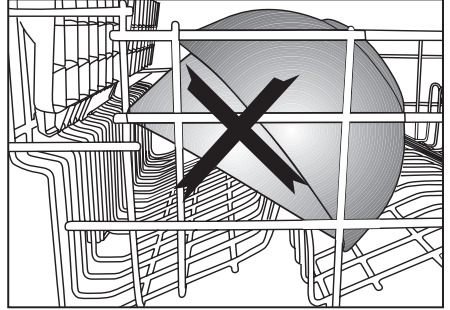

Collapsible upper basket wires

You can use collapsible wires when you need a larger space for your dishes in the upper basket of your machine. To bring the collapsible wires into horizontal position, grab the wire from the middle position and push them in the direction of arrow in the figure. Place your larger dishes into the area created. To bring the wires back to vertical position, just lift them up.

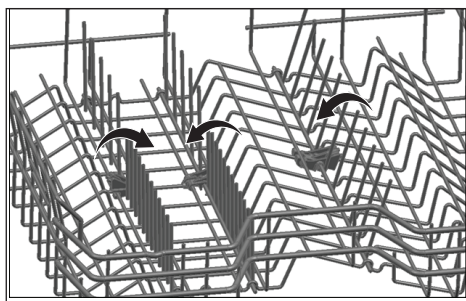

Bringing the wires to the horizontal position by holding them from the tips may cause them to bend. Therefore, hold the wires from their stems while bringing them to the horizontal or vertical positions.

Tray Wash Supports

Use the supports to wash trays in the bottom basket. See the Auxiliary programme and function selection.

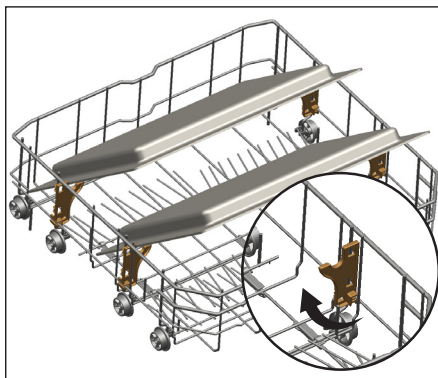

Upper basket multipurpose service rack

This accessory located at the upper basket of your machine allows you to easily wash pieces such as extra long ladles and bread knives.

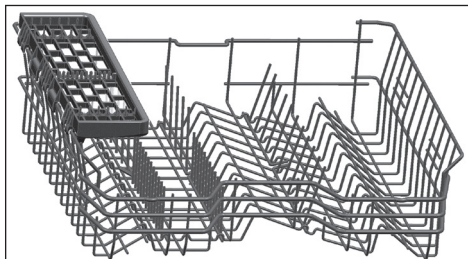

You can lift up the upper basket multipurpose service rack to remove it if you do not want to use it.



If you want to use the upper basket multipurpose service rack again, you can easily attach it to the side section of your upper basket.



Upper basket height adjustable rack

Use the lower and upper parts of the height adjustable racks in the upper basket of the machine by sliding them down or up according to the heights of the glasses, cups or etc. (A, B, C).

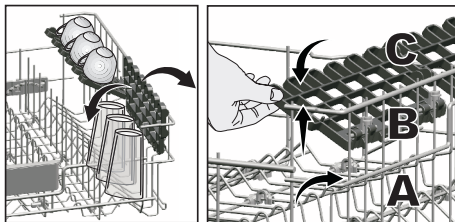

Cutlery basket

Cutlery basket is designed to wash your dishes such as knife, fork, spoon, etc. in an efficient manner.

Since the cutlery basket can be moved (A, B), you can create more space while placing your dishes in the lower basket and free up space for your dishes of different sizes.

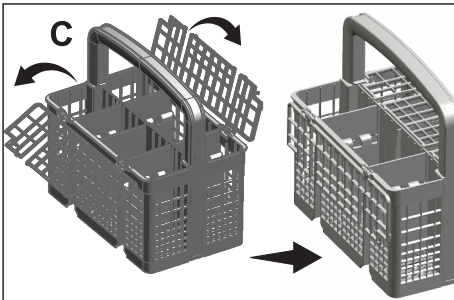
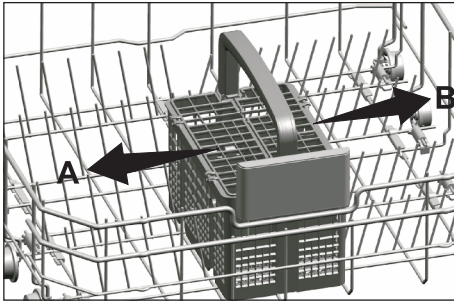

Collapsible lower basket tines

There are foldable tines (A) located at the lower basket of the machine are designed for an easier placement of large pieces such as pans, bowls, etc. You can create larger spaces by folding each tines individually or all of them at once.

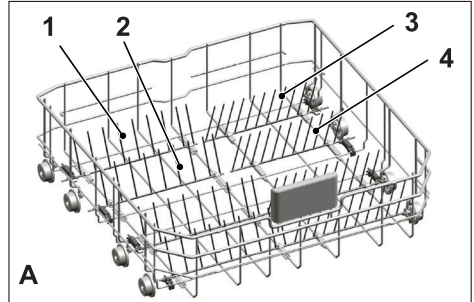

To bring the collapsible tines into horizontal position, grab the tines from mid position and push them in the directions of arrows (B). To bring the tines back to vertical position, just lift them up. Collapsible tines will click into the latch again (C).

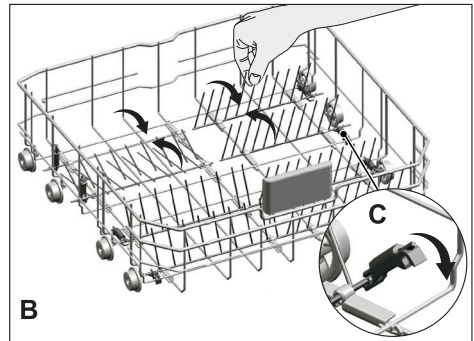

Bringing the tines to the horizontal position by holding them from the tips may cause them to bend. Therefore, it will be appropriate to bring the tines in the middle to horizontal or vertical position by holding them from their stems and pushing in the direction of arrow.

Adjusting the height of the upper basket

The upper basket height adjustment mechanism has been designed for you to create large spaces in the lower or upper sections of your machine depending on your needs by adjusting the height in the upper or lower direction while your basket is empty or loaded.

Thanks to this mechanism, you can use your basket in three different positions, namely lower, middle and upper positions (1, 2, 3).

1. To raise your basket, hold the upper basket wires with both hands while the basket is in the lowermost position and pull them up (A).
2. You will hear a "Click" from the right and left mechanisms, indicating that the basket has reached the next level. Release the basket.

Repeat the process if the height is not sufficient.

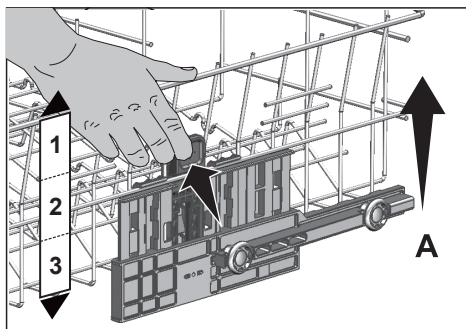

To lower the basket, while it is in the uppermost position;

1. Hold the upper basket wires with both hands, slightly lift up the basket and simultaneously push and release the latches shown in the figure (B).
2. Lower the basket from its current position to the lower one.
3. Release the basket after it has reached one level down.

Repeat the process if the height is not sufficient.

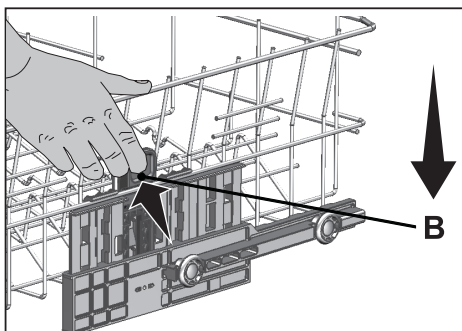

The movement mechanism may not function properly if the upper basket is overloaded or if the weight distribution is not balanced. In heavier conditions, there is the risk of falling one level down.



Make sure that the adjustment mechanism has the same positions on the right and left sides of the upper basket.

5 Operating the product

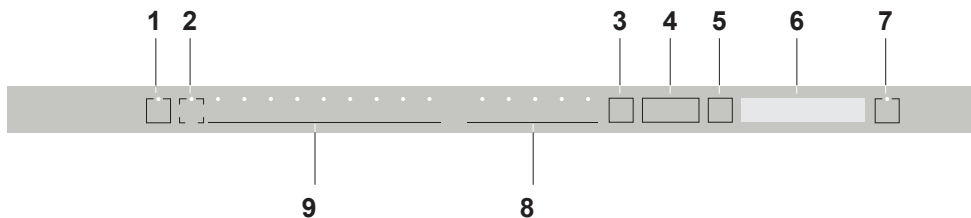

1. On / Off Key
2. RemoteStart Key
3. Menu Key
4. Time Delay Selection / Menu Direction Selection Keys
5. Selection / Confirmation Key
6. Display
7. Start / Pause / Cancel Key
8. Function Selection Keys
 - F1 AqualIntense Function
 - F2 Fast+ Function
 - F3 SteamGloss Function
 - F4 Super Rinse Function
 - F5 Half Load function
9. Programme Selection Keys

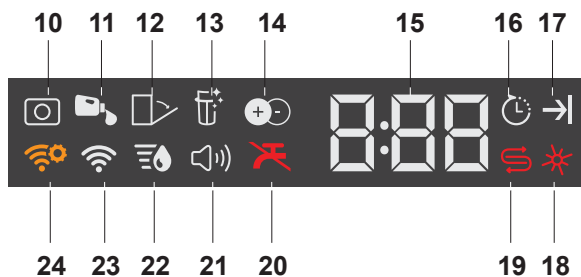

10. Tablet Detergent Indicator (depends on the model)
11. Liquid Detergent Dosing Indicator (depends on the model)
12. Auto Door Open Indicator (depends on the model)
13. Filter Cleaning Function Indicator (depends on the model)
14. IonGuard Function Indicator (depends on the model)
15. Delay Time / Programme Time Indicator
16. Delayed Start Indicator
17. End of Programme Indicator
18. Rinse Aid Indicator
19. Salt Indicator
20. Water Cut-off Indicator
21. Sound Settings Menu Indicator
22. Water Hardness Settings Menu Indicator
23. HomeWhiz Indicator
24. HomeWhiz Setting Indicator

On/Off Key

When you press the On/Off key, the indicator lights illuminate on the display for ON position. The lights turn off in OFF position.

Programme Selection / Programme Cancel key

Select the desired programme using the "programme selection keys" and press the button.

To cancel the running programme, open the door of the machine and press and hold the Programme Start/Pause/Cancel key for 3 seconds.

After the 3 - 2 - 1 countdown, 0:01 is displayed, close the door of the product and wait for the draining process complete. Draining is completed in 2 minutes and the machine gives an audible warning when it is completed.

Function Keys

If you press any of the Function keys during programme selection or time delay selection, an affirmative key signal will be heard provided that the relevant function is supported by the selected programme. Function will be deemed selected when the indicator of the selected function is lit. To cancel the selected function, keep the function key pressed until the function indicator disappears.

Preparing the machine

1. Open the door of the dishwasher.
2. Place the dishes in accordance with the instructions in the user manual.
3. Make sure that the upper and lower impellers rotate freely.
4. Put adequate amount of detergent into the detergent dispenser.

Programme selection

1. Press the On/Off button to turn on your machine.
2. Check the Salt and Rinse Aid indicators and add salt and/or rinse aid if needed.
3. Refer to the table of "Programme data and average consumption values" to determine a washing programme suitable for your dishes.
4. Selected programme will start when you close the door of your machine.

Programme Table

Programme number	1	2	3	4	5	6	7	8	9
Programme name	Auto	AquaFlex	Intensive	Eco *	Glass Care	Quick&Shine	Mini	Prewash	Downloaded Programme
Cleaning temperature	40-65 °C	-	70 °C	50 °C	40 °C	60 °C	35 °C	-	-
Degree of Soiling	Determines the soiling degree of the dishes and sets the temperature and amount of the washing water as well as the washing time automatically. Suitable for all types of dishes.	It is the most suitable washing programme for daily mixed dishes including plastic items. While delicate glass items are washed in the upper basket, pans and trays can be washed in the lower basket.	Suitable for heavily soiled dishes, pots and pans.	Most economical washing programme for the medium soiled daily dishes that are kept waiting.	Special programme for gentle cleaning of delicate glassware.	Daily washing programme for normally soiled dishes in the fastest way.	Suitable for lightly soiled daily dishes that are scraped or pre-cleaned.	Suitable for removing the remnants on the soiled dishes that will be kept waiting in the machine for a few days, and thus, for preventing the bad odour buildup.	Please see the table on the other page for programmes you can download through wireless connection.
Prewash	+	+	+	Medium	Low	Low - Medium	Low	-	-
Wash	+	+	+	+	+	+	+	+	-
Dry	+	+	+	+	+	+	-	-	-
Duration (min)	110-178	203	170	220	120	58	30	15	
Water (l)	9,4-12,4	19	16,8	9,5	13,6	10,6	10,8	4	
Energy (kWh)	0,90-1,45	1,53	1,51	0,93	1,20	1,18	0,80	-	

The consumption values shown in the table were determined under standard conditions. Differences may therefore occur under practical conditions. * Reference programme for testing institutes. The tests in accordance with EN 50242 must be carried out with a full water softener salt dispenser and a full rinse acid reservoir, and using the test programme.

Downloaded Program				
Programme number	1	2	3	4
Programme name	*Baby Protect	Clean&Shine	SilentWash	InnerClean
Cleaning temperature	70 °C	65 °C	-	-
Degree of Soiling	Suitable for the dishes which require extra hygiene such as articles for babies. Also suitable for heavily soiled dishes.	Daily washing programme for normally soiled dishes.	It is the daily washing programme to wash the normally soiled left dishes in the most silent way.	This programme is recommended to be operated on every 1-2 months for machine cleaning and necessary hygiene. The programme should be operated while the machine is empty. In order to achieve an efficient result use together with special machine.
Prewash	High	Medium	Medium	-
Wash	+	-	+	-
Dry	+	+	+	-

The default Downloaded Program of the product is shown with (*).

Auxiliary functions

Washing programmes of your dishwasher are designed to obtain the best cleaning effect, considering the type of the soiling, soiling degree and properties of the dishes to be washed.

Auxiliary functions allow you save from time, water and power.



Auxiliary functions may cause changes in the programme duration.



Auxiliary functions are not suitable for all washing programs. Indicator of the auxiliary function that is not compatible with the programme will not be active.

Aqualtense Function

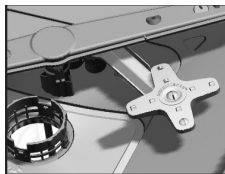

Aqualtense impeller located under the lower impeller helps washing your heavily soiled dishes placed in the right side of the

lower basket. It will give better results to place the most soiled dish to the right front side.



Do not try to remove the Aqualtense impeller!

Fast+ Function

It shortens the time of the washing cycle selected and decreases water consumption by enabling washing under higher pressure.

SteamGloss Function

It provides superior drying performance.

Super Rinse Function

Depending on the type of the detergent used, if a detergent dissolving issue is encountered it will remove the resulting stains from the dishes and enables the optimum rinsing performance.

Half Load function

It is used to operate the machine without loading it completely.

1. Load your dishes in the machine as you like.
2. Turn the machine on with On/Off key.
3. Select the desired programme and press the Half Load key.

While the function is active, the selection indicator on the selected function key will become on.

4. Close the door of the machine to start the programme.



With the Half Load function you can save both water and power while using the lower and upper baskets of the machine.

Floor illumination

Warning to show that machine is in washing phase

(depends on the model)

Your machine reflects a light to the floor during the washing process. This light turns off after the washing process is complete.



Floor illumination is activated automatically when the washing programme starts and remains lit until the end of the programme.



Floor illumination cannot be cancelled by the user.

Functions Under the Settings Menu

(depends on the model)

Under the settings menu of your product, there are some additional functions that depend on the model.

To access these functions, press and hold the Menu key for 3 seconds. Use <- and +> to proceed to the desired function or setting.

Use the selection key to change the desired function or setting and press the Menu key to exit the Settings menu.

	<p>The function indicator will light up even if the functions activated on the settings menu are not active in the selected washing programme.</p>
--	--

Submenu Functions:

(depends on the model)

Doormatic Function Off/On



Detergent Tablet Function Off/On



EverClean Function Off/On



IonGuard Function Off/On



Liquid Dosing Function Off / On



Liquid Dosing Function detergent use setting:

- Level 1: 10 cc lower than the default value
- Level 2: 5 cc lower than the default value
- Level 3: Use the default detergent amount determined by the programme.
- Level 4: 5 cc higher than the default value
- Level 5: 10 cc higher than the default value

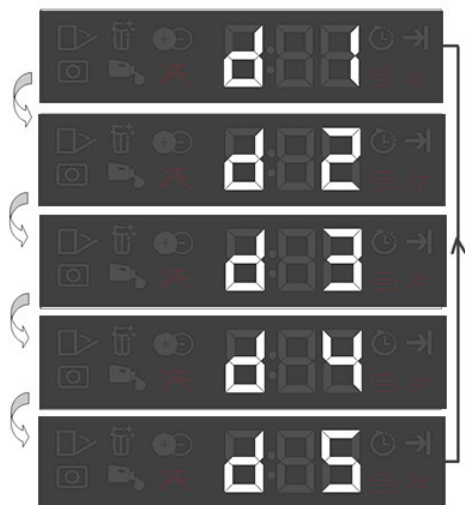

Tablet detergent function

Allows to obtain a better drying performance from the multi-purpose detergents called as all in one detergents such as 2in1, 3in1, 4in1, 5in1 and etc., depending on the hardness level of the tap water.



If you have used the Tablet features during the last washing programme you used, Tablet function will remain active in the next washing programme you will select.



Tablet Detergent function may cause change in the programme duration.

Automatic Detergent Dosing Function

The Automatic Detergent Dosing function automatically adjusts the liquid/gel detergent use according to the selected washing programme and your settings.



To activate or deactivate the function, proceed to "Functions" under the "Settings" menu and follow the instructions regarding the automatic liquid/gel detergent dosing function.

Changing Warning Sound Volume

1. After switching on your machine, press the Menu key for 1 second.
2. Press < - and > + to proceed to "S:" on the display.
3. Each pressing on the Selection key will change the warning sound volume as "S:0" off, "S:1" medium and "S:2" high.
4. Press the Menu key to exit the settings menu. Your setting will be saved automatically.



Your machine is set to "S:2" as factory default.

Scheduling the washing time

Time Delay

If an economical electricity tariff is applied in your region, you can use the Time Delay function to wash your dishes during appropriate hours.

You can delay the start of the selected programme until 24 hours.

1. Press the Time Delay function key after selecting the washing programme and other auxiliary functions.

2. Once you press the Time Delay key, Display Information Line will show "0:30" and Time Delay indicator will start flashing.
3. Set the desired time by pressing the Time Delay key. Time will increase with increments of 30 minutes up to 6 hours and after that in 1 hour increments up to 24 hours every time you press the key.
4. Close the door of your machine after setting the Delayed Start. Once the delay time is over, the selected programme will start automatically.

Changing the settings while Time Delay function is active

While the Time Delay function is activated, you cannot make changes in the washing programme, auxiliary functions or the duration of delay time.



Programme and auxiliary functions cannot be set/changed after the programme has started.

To cancel the Time Delay function

Open the door of the product Press and hold the Programme Selection / Programme Cancel keys for 3 seconds. After the 3 - 2 - 1 countdown, 0:01 is displayed, close the door of the product and wait for the draining process complete. Draining is completed in 2 minutes and the machine gives an audible warning when it is completed.



You can select and start a new programme following the cancellation of Time Delay function.



Time Delay function cannot be set after the programme starts.

Starting the programme

Close the door of your machine to start it after selecting the programme and auxiliary functions.



Your machine performs water softening depending on the hardness level of the supply water. Washing time can change while the programme is running depending on the ambient temperature where your machine is installed, temperature of the supply water and amount of the dishes.



Pay attention not to open the door of the machine when it is running. There may be a rush of vapour when you open the door of your machine; be careful.



The machine will remain silent in pause mode for some time in order to remove the water from the machine and on the dishes completely and to have the water softener cleaned, and then it will resume running in drying mode.

Cancelling the programme

Open the door of the product Press and hold the Programme Selection / Programme Cancel keys for 3 seconds. After the 3 - 2 - 1 countdown, 0:01 is displayed, close the door of the product and wait for the draining process complete. Draining is completed in 2 minutes and the machine gives an audible warning when it is completed.



There might be residues of detergent or rinse aid in the machine and/or on the pieces being washed depending on the step the programme you have cancelled was in.

Salt indicator (S)

Please check the salt indicator on the display to see whether there is adequate amount of softening salt in the dishwasher or not. You need to refill the salt reservoir with salt whenever salt indicator appears on the display of your machine.



Adjusting the water hardness level is explained in Water Softening System section.

Rinse Aid indicator (☼)

Please check the rinse aid indicator on the display to see whether there is adequate amount of rinse aid in the dishwasher or not. You need to refill the rinse aid reservoir with rinse aid whenever rinse aid indicator appears on the display of your machine.

Adjusting the amount of rinse aid

1. After switching on your machine, press the Menu key for 1 second.
2. Using <- and +> keys, proceed to "P:" on the display.
3. Set to the appropriate level with the Selection key.
4. Press the Menu key to exit the settings menu. Your setting will be saved automatically.

No rinse aid dispensed in P:0 wash position.

1 dose of rinse aid is dispensed in P:1 position.

2 doses of rinse aid are dispensed in P:2 position.

3 doses of rinse aid are dispensed in P:3 position.

4 doses of rinse aid are dispensed in P:4 position.

End of programme



When the programme you have selected comes to an end, an audible warning signal will warn you to turn off your machine. This audible signal will warn you with certain intervals before it turns off.

End of Programme indicator will light up when the washing programme is over.

1. Open the door of the machine.
2. Press On/Off key to turn off your machine.
3. Close the tap.
4. Unplug the machine from the socket.



For energy saving, the machine is automatically turned off following the completion of the programme or if the programme is not started.



Leave your dishes in the machine for about 15 minutes to allow them cool down after they are washed. Your dishes will dry in a shorter time if you leave the door of your machine ajar during this period. This process will increase the drying effectiveness of your machine.

Water cut-off warning

If mains water is cut or water inlet tap is turned off the machine cannot take water in and E:02 icon will flash on the programme indicator. As long as the problem continues, washing programme is paused and the water inlet is checked regularly by the machine; when the water is restored E:02 icon will disappear after a while and the washing programme resumes.

Overflowing warning

If the machine intakes too much water or there is leakage at any of the components then the machine will detect this and E:01 icon will flash on the Programme indicator. As long as the overflowing continues safety algorithm will be active and try to discharge the water. If overflowing stops and safety is assured, E:01 icon will disappear. If E:01 does not disappear, there is a permanent fault. In this case the authorised service should be contacted.

6 HomeWhiz Function

You can check your dishwasher and learn about its status via your smart device with the HomeWhiz function.



You can use your machine via your smart device while the function is selected. You can monitor your machine through the application when the function is not selected.



You can check the indicator on the product to see if the function is enabled or not. If the function is disabled, the Wireless indicator will be off or continuously flash at short intervals. For example, when the wireless connection setting is off or the door of the machine is open.



The function will be disabled when the door of the dishwasher is open or when operations regarding On/Off are performed on the machine. It can be enabled again with the remote control key.



The display when HomeWhiz is enabled.

HomeWhiz Setup and User Account Settings

Install the HomeWhiz application from the application store of your smart device to use the WLAN function of your machine. Make sure that your smart device is connected to the internet to use the application. If you are using the application for the first

time, complete the registration process with your e-mail address on the application. Once you've completed the registration process, you can use all HomeWhiz supported appliances in your house through this account.

You can tap "Add/Remove Appliance" under the "Appliances" section to see the appliances paired with your account. You can perform the user pairing processes of these appliances from this page.

Initial setup

- 1 Tap "Add/Remove Appliance" section on the HomeWhiz application.
- 2 Tap "Tap here to setup a new appliance".
3. When the product is off, press the on/off and remote start keys simultaneously to enter the settings menu. Press the selection key to set the product to "wireless connection setup" status.
4. Then, in the settings section of your smart device, connect to "HomeWhiz xxx-xxxx" network under the Wireless settings. Password of the network can be seen on the HomeWhiz application.
5. Connect your smart device to the HomeWhiz network and return to the HomeWhiz application. On the application, you can see the dishwasher you are adding. Tap Next to proceed to the next step.
6. Select the network to which you want to connect your dishwasher and enter the password.
7. While the dishwasher is connecting to the selected network, you will see the Wireless icon (📶) flashing. Once the connection has been established, the said icon will become on permanently.

- Once your dishwasher is connected to the selected network, you need to connect to the same network on your smart device. If your smart device does not get connected automatically, go to its settings and connect it to the network to which your dishwasher is connected.
 - Return to the HomeWhiz application and give a name to your dishwasher. This is the last step. You can see your product on the "Products" page.
 - Once the setup of the dishwasher has been performed successfully, the product will show the main screen automatically and return to the use mode.
 - If the setup has failed, or if it could not be completed within 5 minutes in the setup mode, the Wireless icon will go off and the product will switch to the off mode. To perform setup again, please repeat the steps starting from step 1.
- Tap "Add/Remove Appliance" on the Products page. You can see the appliance and the user it belongs to under "Other Appliances" tab.
 - Tap (+) next to the dishwasher you want to add and give a name to the appliance.
 - Your request to add the appliance will be sent to its owner via e-mail. You can start to use the appliance jointly once the owner confirms your request.



Your smart device and dishwasher do not need to be connected to the same network once the setup processes are complete. You can use your appliance as long as your smart device is connected to the internet.



You can tap "Add/Remove Appliance" under the "Appliances" section to see the appliances paired with your account. You can perform the user pairing processes of these appliances from this page.

Using the dishwasher on more than one device

You can use your dishwasher on more than one smart device. Install the HomeWhiz application on the other smart device to use this feature. You need to log in with your account upon launching the application.



If the account you have logged on is the one to which you have added appliance(s) before, you can start using your dishwasher directly after logging in.

Follow the steps below to use an already setup dishwasher through a new account.

- Create a new account and use this account to log into the HomeWhiz application. Make sure that your smart

HomeWhiz on/off

Press the remotestart key to enable the function.



Product indicator when the function is enabled.

If you press the remote start key while the function is enabled, the Home Whiz function

will be disabled, and the product indicator will return to the delay time/programme time display. In the off position, the HomeWhiz key LED will go off.



You can check the indicator on the product to see if wireless connection is enabled or not. If the wireless connection is off, you can see that the Wireless icon is off.

If the Wireless icon is on, this means that the wireless connection of the product is on and the product is connected to the wireless network. If the Wireless icon is continuously flashing at regular intervals, this means that it is enabled but could not connect or is trying to connect the network.

Wireless connection is on / off When the machine is on, press the "Menu" key for 1 second to enter the settings menu. Follow the screen and press < - and + > keys on the panel, then wait until the Wireless connection indicator comes on. Press the selection key and if the Wireless connection is on, turn it off; if it is off, turn it on. In the wireless connection on/off settings menu, if the wireless connection is on, the Wireless connection indicator will light permanently; if it is off, the Wireless connection indicator will flash at short intervals.

Once the wireless connection has been turned "On", your machine will connect to the home network by using the setup settings you made before.

Deleting the HomeWhiz settings

While the dishwasher is on, press the "Menu" key for 1 second to enter the settings menu. Follow the screen and press < - and + > keys on the panel, then proceed

until the Wireless setting indicator comes on. Press and hold the selection key for 5 seconds. After the 5 - 4 - 3 - 2 - 1 countdown on the display, your settings will be deleted.

HomeWhiz troubleshooting

Follow these instructions if you encounter a control or connection problem. If it persists, take the next step.

1. Check if your smart device is connected to the internet.
2. Close the HomeWhiz application on your smart device and start it again.
3. Restart your smart device.
4. Check the wireless connection status of your dishwasher. If you see "WLAN: Off", switch it to "WLAN: On" and wait for the machine to connect. Then close the HomeWhiz application on your smart device and start it again.
5. If the connection cannot be established following the instructions above, repeat the initial setup settings on the appliance.
6. If the problem persists, contact the authorised service.

Changing the Downloaded Program

You can use the HomeWhiz application to change the Downloaded Programme, which is the last program on the product. You can check the Table of Program Data and Average Consumption Values to see what the downloaded programs might be and the default Downloaded Program.

To change the Downloaded Program:

- Connect to your product on the HomeWhiz application.
- Turn on the Remote Control function for the product.

HomeWhiz Function

- Go to the settings page of the product on the HomeWhiz application.
- On the settings page of the product, proceed to the Download Program page.
- On the Download Program page, select a program to download on your product.
- Select the desired program on the Download Program page, and press Download Program on the HomeWhiz application.
- While the program is being downloaded, you will see an animation on the program and HomeWhiz application.
- Once the download procedure is complete, you can select and install the Downloaded Program on the product or the HomeWhiz application.



You can check the Table of Program Data and Average Consumption values to see the programs you can download on your product.



If you download another program on the product, your previous selection will be cancelled.



You can download as many programs as you wish on the product, and change the Downloaded Program whenever you want. You just need to make sure that your smart device and product are connected to the internet and the Remote Control function of the product is turned on.

7 Maintenance and cleaning

Service life of the product extends and frequently faced problems decrease if it is cleaned at regular intervals.



Unplug the product and turn off the tap before attempting any cleaning procedures.



Do not use abrasive substances for cleaning.



Clean the filter and impellers at least once a week in order for the machine operates efficiently.

Cleaning the outer surface of the product

Wipe the outer surface and door gaskets of the product gently with a mild cleaning material and damp cloth. Wipe the "Control panel" only with a slightly damp cloth.

Cleaning the interior of the machine

- Clean the interior of the machine and the tank by running a programme with or without detergent based on the degree of soil.
- If water has remained in the machine, drain the water by performing the procedures under the topic "Canceling a programme". If the water cannot be discharged, remove the filters as specified in the "Cleaning the filters" section and check if there are any leftover deposits that have accumulated at the bottom of the machine, blocking the water path. Clean if necessary.

Cleaning the filters

Clean the filters at least once a week in order for the machine operates efficiently. Check if food residues are left on the filters. If there are food residues on filters, take them out and clean well under running water.



Filter cleanliness is increased by 80% with the micro filter cleaning system available on your machine.

1. Turn the micro filter (1) and coarse filter (2) assembly counter clockwise and pull it out from its seating.

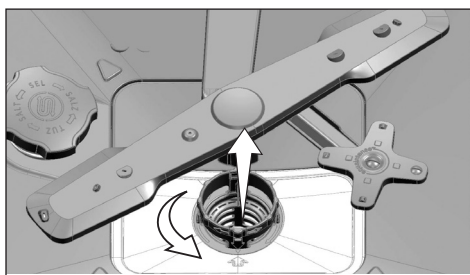

2. Pull out the metal/plastic filter (3) from the seating.

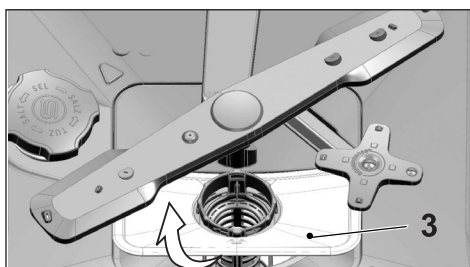

3. Press the two pawls on the coarse filter inwards and separate the coarse filter from the assembly.

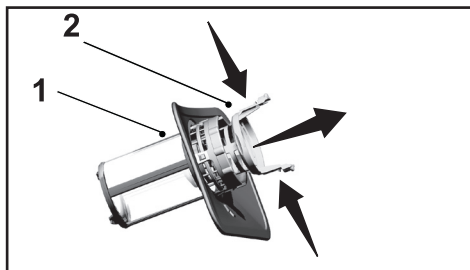

4. Clean all three filters under tap water by means of a brush.



Do not remove the micro filter cleaning mechanism (4) for cleaning (D).

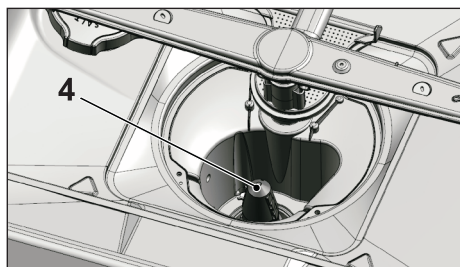

5. Install the metal/plastic filter.
6. Place the coarse filter into the micro filter. Make sure that it is properly seated. Turn the coarse filter clockwise until a "click" sound is heard.



Do not use the dishwasher without filter.



Incorrect placement of the filters will reduce washing efficiency.

Cleaning the hose filter

Damages on the machine that may be caused by impurities coming from the urban supply water or your own water installation (such as sand, dirt, rust, etc.) can be prevented by means of the filter attached to the water inlet hose. Check the filter and the hose regularly and clean them if necessary.

1. Turn off the tap and remove the hose.
2. After taking out the filter, clean it under running tap water.
3. Place the cleaned filter back to its seat in the hose.
4. Install the hose to tap.

(depends on model)

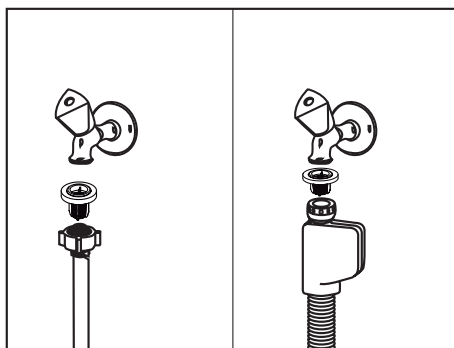

Cleaning the impellers

Clean the impellers at least once a week in order for the machine operates efficiently.

Lower impeller

Check if the holes on the lower impeller (1) are clogged. If they are clogged, remove and clean the impeller. You can pull the lower impeller up to remove it.

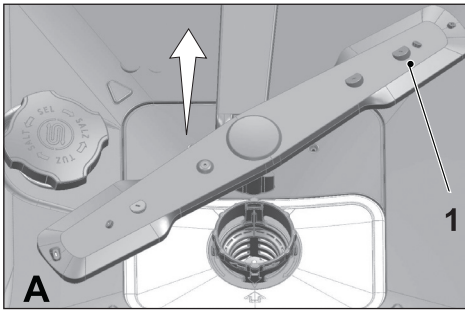

Upper impeller

Check if the holes on the upper impeller (1) are clogged. If they are clogged, remove and clean the impeller. Turn its nut to left to remove the upper impeller.

Make sure that the nut is tightened well when installing the upper impeller.

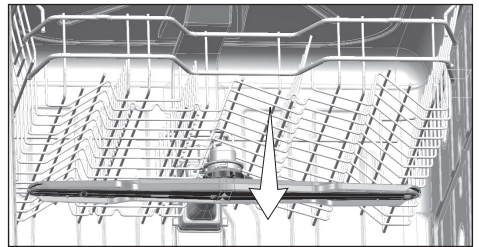
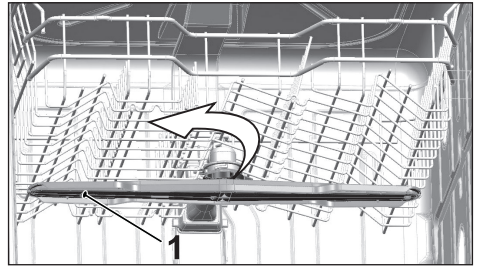

8 Troubleshooting

Machine does not start.

- Power cable is unplugged. >>> Check if the power cable is plugged in.
- Fuse is blown. >>> Check the fuses in your house.
- Water is cut. >>> Make sure that the water inlet tap is open.
- Door of the machine is open. >>> Make sure that you have closed the door of the machine.
- On / Off button is not pressed. >>> Make sure that you have turned on the machine by pressing the On / Off button.

Dishes are not washed clean

- Dishes are not placed orderly in the machine. >>> Load the dishes as described in the user manual.
- Selected programme is unsuitable. >>> Select a programme with a higher temperature and cycle time.
- Impellers are stuck. >>> Prior to starting the programme, turn the lower and upper impellers by hand to make sure that they rotate freely.
- Impeller holes are clogged. >>> Lower and upper impeller holes might be clogged with food remnants such as lemon pips. Clean the impellers regularly as illustrated in section "Cleaning and Care".
- Filters are clogged. >>> Check if the filter system is clean. Clean the filter system regularly as illustrated in section "Cleaning and Care".
- Filters are installed incorrectly. >>> Check the filter system and make sure that it is installed correctly.
- Baskets are overloaded. >>> Do not overload the baskets in excess of their capacity.
- Detergent is stored under unsuitable conditions. >>> If you are using powder detergent, do not store the detergent package in humid places. Keep it in a closed container if possible. For ease-of-storing, we recommend you to use tablet detergents.
- Detergent is not sufficient. >>> If you are using powder detergent, adjust the amount of detergent according to the soiling degree of your dishes and/or programme definitions. We recommend you to use tablet detergents for optimum results.
- Rinse aid is not sufficient. >>> Check the rinse aid indicator and add rinse aid if necessary. Increase the rinse aid setting if there is enough amount of rinse aid in the machine.
- Detergent dispenser lid is left open. >>> Make sure that the detergent dispenser lid is closed tightly after adding detergent.

Dishes are not dry at the end of cycle

- Dishes are not placed orderly in the machine. >>> Place your dishes in a way that no water will accumulate in them.

Troubleshooting

- Rinse aid is not sufficient. >>> Check the rinse aid indicator and add rinse aid if necessary. Increase the rinse aid setting if there is enough amount of rinse aid in the machine.
- Machine is unloaded right after the programme is over. >>> Do not unload your machine right after washing process is completed. Slightly open the door and wait for evacuation of the steam inside for a while. Unload the dishes after the pieces cool down to a touchable level. Start unloading process from the lower basket. Thus, dropping of water remained on a piece at upper basket onto the pieces at lower basket is prevented.
- Selected programme is unsuitable. >>> Since rinsing temperature is low at programmes with short duration, drying performance will also be low. Select programmes with longer duration for a higher drying performance.
- Surface quality of the kitchen utensils is deteriorated. >>> Desired washing performance can not be obtained on kitchen utensils with deteriorated surfaces and it is not suitable to use such utensils in terms of hygiene as well. Also, water can not flow easily on deteriorated surfaces. It is not recommended to wash such kitchen utensils in dishwasher.



It is normal that drying complaints can be experienced with Teflon kitchen utensils. It is associated with the structure of Teflon. Since the surface tensions of Teflon and water are different, water droplets will remain as beads on the Teflon surface.

Tea, cafe or lipstick stains remain on dishes.

- Selected programme is unsuitable. >>> Select a programme with a higher temperature and cycle time.
- Surface quality of the kitchen utensils is deteriorated. >>> Tea and cafe stains or other dye spots may not be cleaned in dishwasher when they have penetrated in deteriorated surfaces. Desired washing performance can not be obtained on kitchen utensils with deteriorated surfaces and it is not suitable to use such utensils in terms of hygiene as well. It is not recommended to wash such kitchen utensils in dishwasher.
- Detergent is stored under unsuitable conditions. >>> If you are using powder detergent, do not store the detergent package in humid places. Keep it in a closed container if possible. For ease-of-storing, we recommend you to use tablet detergents.

Lime traces remain on dishes and glassware gains a misty appearance

- Rinse aid is not sufficient. >>> Check the rinse aid indicator and add rinse aid if necessary. Increase the rinse aid setting if there is enough amount of rinse aid in the machine.
- Water hardness setting is low or salt level is insufficient >>> Measure the hardness of the supply water appropriately and check the water hardness setting.
- Salt leakage exists. >>> Pay attention not to spill salt around the salt filling hole while adding salt. Make sure that the salt reservoir lid is tightly closed after finishing the filling process. Run the prewash programme to remove the salt that spilled inside the machine. Since the salt granules that will remain under the lid will dissolve during prewash, causing the lid loosen, check the lid once again at the end of the programme.

There is a different odour in the machine



A new machine has a peculiar odour. It will fade out after a couple of washes.

- Filters are clogged. >>> Check if the filter system is clean. Clean the filter system regularly as illustrated in section "Cleaning and Care".
- Dirty dishes are kept in dishwasher for 2-3 days. >>> If you are not going to start the machine right after you have put the dishes into it, remove the remnants on the dishes and run the Prewash programme without detergent every 2 days. In such cases, do not close the door of the machine completely in order to avoid odour build up in machine. You can also use commercially available odour removers or machine cleaners.

Rust, discoloration or surface deterioration occurs on dishes

- Salt leakage exists. >>> Salt may cause deterioration and oxidation on metal surfaces. Pay attention not to spill salt around the salt filling hole while adding salt. Make sure that the salt reservoir lid is tightly closed after finishing the filling process. Run the prewash programme to remove the salt that spilled inside the machine. Since the salt granules that will remain under the lid will dissolve during prewash, causing the lid loosen, check the lid once again at the end of the programme.
- Salty food remnants have remained on dishes for a long time. >>> If cutlery soiled with such foods will be kept waiting in machine, dirt must be removed by prewash or dishes must be washed without being kept waiting.
- Electric installation is not grounded. >>> Check if your machine is connected to the actual grounding line. Otherwise, the static electric created in the product causes arcs on the surfaces of metal items creating pores, removing the protective cover on the surface and causing discoloration.
- Intensive cleansers such as bleaches are used. >>> Protective cover on metal surfaces gets damaged and loses its efficiency in time when it gets in contact with cleansers such as bleach. Do not wash your dishes with bleach.
- Metal items particularly knives are used for purposes other than their intended uses. >>> Protective cover on the edges of knives may get damaged when they are used for purposes such as opening cans. Do not use metal kitchen utensils out of their intended uses.
- Cutlery are made of low quality stainless steel. >>> Corrosion on such items is inevitable; they should not be washed in dishwashers.
- Kitchen utensils that are already corroded are washed in dishwasher. >>> Rust on a corroded item can migrate to other stainless steel surfaces and cause corrosion on those surfaces as well. Such items should not be washed in dishwashers.

Detergent remains in detergent dispenser.

- Detergent dispenser was damp when adding detergent. >>> Make sure that the detergent dispenser is dried well prior to filling it with detergent.
- Detergent is added long before the washing process. >>> Pay attention to add detergent shortly before start-up of the washing.
- Opening of the detergent dispenser lid is prevented during washing. >>> Place the dishes in a way that will not prevent the detergent dispenser lid from opening and the water going into the machine from impellers.
- Detergent is stored under unsuitable conditions. >>> If you are using powder detergent, do not store the detergent package in humid places. Keep it in a closed container if possible. For ease-of-storing, we recommend you to use tablet detergents.
- Impeller holes are clogged. >>> Lower and upper impeller holes might be clogged with food remnants such as lemon pips. Clean the impellers regularly as illustrated in section "Cleaning and Care".

Decorations and ornaments on kitchen utensils are being erased.



Decorated glasses and decorated lustre porcelains are not suitable for washing in the dishwasher. Manufacturers of some glassware and porcelain tableware items do not recommend washing such kitchen utensils in the dishwashers either.

Dishes are scratched.



Kitchen utensils that contains or are made of aluminium should not be washed in dishwasher.

- Salt leakage exists. >>> Pay attention not to spill salt around the salt filling hole while adding salt. Spilled salt can cause scratches. Make sure that the salt reservoir lid is tightly closed after finishing the filling process. Run the prewash programme to remove the salt that spilled inside the machine. Since the salt granules that will remain under the lid will dissolve during prewash, causing the lid loosen, check the lid once again at the end of the programme.
- Water hardness setting is low or salt level is insufficient >>> Measure the hardness of the supply water appropriately and check the water hardness setting.
- Dishes are not placed orderly in the machine. >>> When placing the glasses and other glassware into the basket lean them not against other dishes but the edges or racks of the basket or the glass support tines. Striking of the glasses to each other or to other dishes due to the impact of water during washing can cause breaks, or scratches on their surfaces.

A smear remains on glasses that resembles milk stain which can not be removed when wiped by hand. A bluish / rainbow appearance occurs when the glass is pointed to light.

- Excessive rinse aid is used. >>> Lower rinse aid setting. Clean the spilled rinse aid when adding rinse aid.
- Corrosion has occurred on glass due to soft water. >>> Measure the hardness of the supply water appropriately and check the water hardness setting. If your supply water is soft (<5 dH), do not use salt. Choose programmes that wash in higher temperatures (e.g. 60-65°C). You can also use glass protective detergents that are commercially available.

Foam forms in the machine.

- Dishes are washed with hand-wash detergent by hand but not rinsed before placing them into the machine. >>> Hand-wash detergents do not contain antifoam. There is no need to hand-wash the dishes before placing them into the machine. Removing the coarse soil on the dishes under tap water, with a tissue paper or fork will be sufficient.
- Rinse aid has spilled into the machine when adding rinse aid. >>> Take care that rinse aid is not spilled in the machine when you are filling it. Clean any spilled rinse aid with the help of a tissue paper/towel.
- Lid of the rinse aid reservoir is left open. >>> Make sure that the lid of the rinse aid reservoir is closed after adding rinse aid.

Kitchen utensils are broken.

- Dishes are not placed orderly in the machine. >>> Load the dishes as described in the user manual.
- Baskets are overloaded. >>> Do not overload the baskets in excess of their capacity.

Water remains in the dishwasher at the end of the programme.

- Filters are clogged. >>> Check if the filter system is clean. Clean the filter system regularly as illustrated in section "Cleaning and Care".
- Discharge hose is clogged/blocked. >>> Check the discharge hose. If necessary, remove the discharge hose, clear the blockage and insert it as illustrated in the user manual.



If you cannot eliminate the problem although you follow the instructions in this section, consult your dealer or the Authorised Service Agent. Never try to repair a nonfunctional product yourself.

8 Guarantee

BEKO UK AND IRELAND STANDARD MANUFACTURER GUARANTEE TERMS AND CONDITIONS

Your new Beko product is guaranteed against faulty materials, defective components or manufacturing defects.

The standard guarantee starts from the date of original purchase of the product, and lasts for a period of twelve (12) months unless Beko plc (the "Manufacturer") agrees to extend the guarantee for the product in writing.

If you have purchased an American style Fridge freezer, the standard guarantee starts from the date of original purchase of the product, and lasts for a period of twenty four (24) months unless Beko plc (the "Manufacturer") agrees to extend the guarantee for the product in writing.

If you have any questions about the guarantee on your product (including how long it is valid), please contact your retailer or our contact centre on 0333 207 9710 (UK and Northern Ireland) or 01 862 3411 (Republic of Ireland)

This guarantee does not in any way diminish or affect your statutory rights in connection with the product. This guarantee is in addition to your statutory rights as a consumer. If you have any questions about these rights, please contact the retailer from which you purchased the product. In certain circumstances, it is possible that your statutory rights may offer additional or higher levels of protection than those offered under the terms of this guarantee.

What is covered by this guarantee?

- Repairs to the product required as a result of faulty materials, defective components or manufacturing defects.
- Functional replacement parts to repair a product.
- The costs of a Beko Approved Engineer to carry out the repair.

What is not covered?

- Transit and delivery damage.
- Cabinet or appearance parts, including but not limited to control knobs, flaps and handles.
- Accessories and/or consumable items including but not limited to ice trays, scrapers, cutlery baskets, filters and light bulbs.
- Repairs necessary as a direct or indirect result of:

Accidental damage, misuse or abuse of a product.

An attempted repair of a product by anyone other than a Beko Approved Engineer (the "Engineer").

Installation or use of a product where such installation or use fails to meet the requirements contained in this guarantee or the User Instructions Booklet.

- Repairs to a product operated at any time on commercial or non-residential household premises (unless we have previously agreed to the installation environment).

This guarantee is limited to the cost of repairing the product. To the extent permitted by law, the Manufacturer does not accept and will not be held liable for any financial loss incurred in connection with the failure of any product to operate in accordance with the expected standards. Such financial loss includes but is not limited to loss arising from:

- Time taken off work.
- Damaged food, clothing or other items.
- Meals taken at restaurants or from takeaways.
- General compensation for inconvenience.

Important Notes

1. Your product is designed and built for domestic household use only.
2. The guarantee will automatically be void if the product is installed or is used in commercial or non-residential domestic household premises, unless we have previously agreed to the installation environment.
3. The product must be correctly installed, located and operated in accordance with the instructions contained in the User Instructions Booklet provided with your product.
4. Professional installation by a qualified Electrical Domestic Appliance Installer is recommended for all Washing Machines, Dishwashers and Electric Cookers (as incorrect installation may result in you having to pay for the cost of repairing the product).
5. Gas Cookers must be professionally installed by a Gas Safe (or Gas Networks Ireland for Republic of Ireland) registered gas installer.
6. This guarantee is given in respect of products purchased and used within the United Kingdom and the Republic of Ireland.
7. This guarantee is effective from the initial date of purchase of a new product from an authorised retailer and will be void if the product is resold.
8. This guarantee does not apply to graded sales (where the product is purchased as a "second").
9. Possession of a copy of these terms and conditions does not necessarily mean that a product has the benefit of this guarantee. If you have any questions, please call our Call Centre on the number set out above.
10. The Manufacturer reserves the right to terminate the guarantee if its staff or representatives are subjected to physical or verbal abuse in the course of carrying out their duties.
11. Optional extras, where available (i.e. extendable feet) are supplied on a chargeable basis only.

Does Beko offer replacements?

This is a repair-only guarantee. On occasion, the Manufacturer may at its sole discretion, replace your product with a new product instead of carrying out a repair. Where a replacement is offered, this would normally be an identical model but when this is not possible, a model of similar specification will be provided. The Manufacturer will cover the costs and arrange for the delivery of the new product and for the return of the old product. Any costs related to disconnecting the faulty product and installing the replacement product will not be borne by the Manufacturer unless previously agreed to in writing. The original guarantee will continue to apply to the replacement product; the new product will not come with a new guarantee.

When will the repair take place?

Our Engineers work Monday to Friday 9.00am to 5.00pm. Appointments outside these hours may be possible at the sole discretion of the Manufacturer but cannot be guaranteed. Whilst our Engineers will endeavour to minimize inconvenience and to meet requests for specific timed appointments, this cannot be guaranteed. We will not be liable for delays or if it is unable to carry out a repair because a convenient appointment cannot be arranged.

Will there be any charge for the repairs?

It is your responsibility to provide evidence to the Engineer that your product is covered by this guarantee with a proof of purchase. The Manufacturer reserves the right to charge for the reasonable cost of any service call if:

- You cannot provide evidence that your product is covered by this guarantee.
- Where a service call has been made and the engineer finds that there is no fault with your product.
- That your product has not been installed or operated in accordance with the User Instructions Booklet.
- That the fault was caused by something other than faulty materials, defective components or manufacturing defects.
- For missed appointments.

Payment of these costs are due immediately upon the Engineer providing you with an invoice. The Manufacturer reserves the right to terminate the guarantee if you fail to pay the costs for the service call in a timely manner.

If you are a resident of the United Kingdom, this guarantee will be governed by English law and subject to the English Courts, save where you live in another part of the United Kingdom, in which case the law and courts of that location will apply.

If you are resident in the Republic of Ireland, this guarantee will be governed by Irish law and the Irish courts will have jurisdiction.

This guarantee is provided by Beko plc. Beko House, 1 Greenhill Crescent, Watford, Hertfordshire. WD18 8QU.

Beko plc is registered in England and Wales with company registration number 02415578.

BEKO UK AND IRELAND BUILT-IN APPLIANCES GUARANTEE TERMS AND CONDITIONS

If you have purchased a built-in or integrated appliance, and registered it within 90 days of purchase by completing the online registration form, then the standard 12 month guarantee will be extended to 24 months, under the same terms and conditions as detailed in our Standard Guarantee Terms and Conditions.

BEKO UK AND IRELAND PROSMART INVERTER MOTOR GUARANTEE TERMS AND CONDITIONS

This 10 year guarantee relates to Beko products that feature the ProSmart Inverter Motor.

The ProSmart Motor guarantee terms and conditions are in addition to our Standard guarantee terms and conditions detailed in the previous section.

In order to activate the 10 year guarantee you MUST register the appliance within 90 days of the original purchase date. You can register by first visiting Beko.co.uk/register and by following the online instructions.

Beko Free standing appliances come with a 12 month parts and labour guarantee as standard,

Beko Built-in appliances come with a 12 month parts and labour guarantee as standard. This is extended to 24 months, free of charge, upon registration of the appliance. When you register your appliance for additional guarantee, you will automatically activate the ProSmart Motor 10 year guarantee. You do not need to register twice. (beko.co.uk/guarantee-terms).

To make a claim against your Beko ProSmart Inverter Motor Guarantee (the "Guarantee"), all customer and product details must be registered with Beko plc using the procedure outlined below.

1. This extra 9 years (for free standing appliances) or 8 years (for built-in or integrated appliances) guarantee is only effective after the expiration of the standard manufacturer's guarantee.
2. It is only valid for the ProSmart Inverter motors of selected washing machines, washer-dryers, tumble dryers and dishwashers. It does not cover any labour charge or any other components of the product. In addition, it is only valid for one replacement of the ProSmart motor during the extra 9-year (for free standing appliances) or 8 year (for built-in appliances) guarantee period.
3. To activate your guarantee, you MUST register your appliance within 90 days of the original purchase date, by visiting beko.co.uk/register.
4. Customers will receive a unique reference code as proof of guarantee validation by email or post, which must be quoted at the time of a claim being made.

Guarantee

5. Any repair/replacement of the ProSmart Inverter motor must only be carried out by an authorised Beko Service Agent (the "Service Agent").
6. Labour for the repair/replacement of the ProSmart Inverter motor is not included in this guarantee and is chargeable directly by the Service Agent.
7. Any additional components fitted to the product at any time will not be covered by this guarantee and will be chargeable directly by the Service Agent.
8. The guarantee is not transferable and cannot be exchanged for cash.
9. There are no alternative or additional offers to this Guarantee.
10. The guarantee is exclusive of the manufacturer's standard guarantee
11. The Terms and Conditions shown above are in addition to the standard terms and conditions of your product guarantee. Please read and refer to such Terms and Conditions when making any claim.
12. We may use the information you provide for marketing purposes and to analyse your purchasing preferences. We may keep your information for a reasonable period for these purposes in accordance with the applicable Data Protection Laws and General Data Protection Regulations (GDPR). You can opt into this service during the registration process. Further details are available at <http://www.beko.co.uk/cookie-and-privacy>.
13. These Terms and Conditions are governed by the laws of England and Wales; manufacturer: Beko plc, Beko House, 1 Greenhill Crescent, Watford WD18 8QU. Company Registration Number: 02415578.

HOW TO OBTAIN SERVICE FOR YOUR APPLIANCE

Please keep your purchase receipt or other proof of purchase details in a safe place; you will need to have this documentation available should the product require attention under guarantee.

Please take a few moments to complete the details below, as you will need this information when you call us, or to use our online services. When you call us you may be required to input your serial number into your telephone keypad. For help please visit beko.co.uk/support/model-finder

- The product model number is printed on the Operating Instruction Booklet / User guide
- The product model and serial number is printed on the Rating Label affixed to the appliance.
- The Retailer (Purchased from) and Date of purchase will be printed on your purchase receipt or other proof of purchase paperwork

Guarantee

Recording of these details alone will not count as proof of purchase. A valid proof of purchase is required for requesting service under guarantee.

Model number Serial number Purchased from Date of purchase

For service under guarantee or for product advice please call our Contact centre

Before requesting service please check the troubleshooting guide in the Operating Instructions booklet, as a charge may be levied where no fault is found, and even though your product may still be under guarantee.

After arranging service the area around the product must be easily accessible to the Engineer, without the need for cabinets or furniture to be removed or moved.

It is your responsibility to ensure our Engineers have a clean and safe environment to carry out any repairs.

Please have your Model number and Serial number available when you call us, as you may be required to input your serial number into your telephone keypad during your call.

UK Mainland & Northern Ireland: 0333 207 9710

Landline or mobile calls to 0333 numbers cost no more than calls to geographic numbers 01 or 02, and are charged at the basic rate. Calls from landlines and mobiles are included in free call packages but please check with your telephone service provider for exact call charges.

Republic of Ireland: 01 862 3411

Service once the manufacturers guarantee has expired

If you have purchased an extended guarantee please refer to the instructions contained within the extended guarantee agreement document, otherwise please call us using the appropriate number above, where service can be obtained at a charge.

Should you experience any difficulty in obtaining service please call us on 0333 207 9710 or 01 862 3411

Contact us though our website

Send us a secure message through our online contact us form. Please visit our website, click Contact Us and choose a product support topic from the list of options. Complete the required details and click send message.

Product registrations

For UK registrations please visit beko.co.uk/register and for the Republic of Ireland visit beko.ie/register.



Free Manuals Download Website

<http://myh66.com>

<http://usermanuals.us>

<http://www.somanuals.com>

<http://www.4manuals.cc>

<http://www.manual-lib.com>

<http://www.404manual.com>

<http://www.luxmanual.com>

<http://aubethermostatmanual.com>

Golf course search by state

<http://golfingnear.com>

Email search by domain

<http://emailbydomain.com>

Auto manuals search

<http://auto.somanuals.com>

TV manuals search

<http://tv.somanuals.com>