

Dryer

User Manual

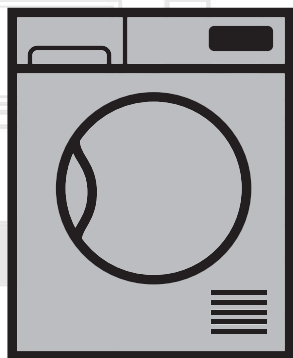

DPHR8PB561W

EN

CE

beko

2960311539_KM/220917.1215

Please read this user manual first!

Dear Customer,





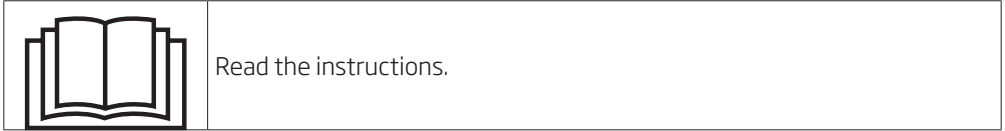

Thank you for preferring a Beko product. We hope that your product which has been manufactured with high quality and technology will give you the best results. We advise you to read through this manual and the other accompanying documentation carefully before using your product and keep it for future reference. If you transfer the product to someone else, give its manual as well. Pay attention to all details and warnings specified in the user manual and follow the instructions given therein.

Use this user manual for the model indicated on the cover page.



Explanation of symbols

Throughout this user manual the following symbols are used:

	Important information or useful hints about usage.
	Warning for hazardous situations with regard to life and property.
	Warning against electric shock.
	Warning against hot surfaces.
	Warning against fire hazard.
	Packaging materials of the product are manufactured from recyclable materials in accordance with our National Environment Regulations.

Do not dispose of the packaging wastes with the domestic waste or other wastes, discard them to the dedicated collection points designated by the local authorities.



This product was manufactured using the latest technology in environmentally friendly conditions.

TABLE OF CONTENTS

1 Important safety and environmental instructions 4

1.1 General safety	4
1.1.1 Electrical safety	5
1.1.2 Product safety	6
1.2 Mounting over a washing machine	8
1.3 Intended use	9
1.4 Child safety	9
1.5 Compliance with the WEEE regulation and disposing of the waste product	10
1.6 Compliance with RoHS Directive:.....	10
1.7 Package information	10
1.8 Technical specifications	11

2 Your Dryer 12

2.1 Overview.....	12
2.2 Package Contents.....	13

3 Installation 14

3.1 Appropriate installation location	14
3.2 Removing the transportation safety assembly	14
3.3 Connecting to the drain	14
3.4 Adjusting the feet	15
3.5 Electrical connection	15
3.6 Transportation of the dryer.....	15
3.7 Warnings about sounds	16
3.8 Changing the illumination lamp	16

4 Electrical Connection 17

4.1 Attention!	17
4.2 Electrical requirements.....	17
4.3 Fitting a different plug	17
4.4 Washer/dryer combination	17

5 Preparation 18

5.1 Laundry suitable for drying in the dryer	18
5.2 Laundry not suitable for drying in the dryer.....	18
5.3 Preparing laundry for drying	18
5.4 Things to be done for energy saving..	18
5.5 Correct load capacity	19

6 Operating the product 20

6.1 Control Panel.....	20
6.2 Screen symbols.....	20
6.3 Preparing the dryer.....	21
6.4 Programme selection	21
6.5 Programme selection and consumption chart.....	22
6.6 RapiDry	25
6.7 Auxiliary functions	25
6.8 Warning symbols	26
6.9 Starting the program	27
6.10 Program progress status.....	27
6.11 Child Lock	27
6.12 Changing the program after it is started	28
6.13 Cancelling the program.....	28
6.14 End of programme	29

7 Maintenance and cleaning 30

7.1 Cleaning Lint Filter / Loading Door Inner Surface	30
7.2 Cleaning the sensor	31
7.3 Draining the water tank	31
7.4 Cleaning the evaporator	32

8 Troubleshooting 33

9 Service 35

Republic of Ireland	35
Service once the manufacturers guarantee has expired.....	35
UK Mainland & Northern Ireland	35

1 Important safety and environmental instructions

This section contains safety instructions that will help protect from risk of personal injury or property damage. Failure to follow these instructions shall void any warranty.

1.1 General safety

- The dryer can be used by children at and above 8 years old and by persons whose physical, sensory or mental capabilities were not fully developed or who lack experience and knowledge provided that they are supervised or trained on the safe usage of the product and the risks it brings out. Children should not play with the product. Cleaning and maintenance works should not be performed by children unless they are supervised by someone.
- Children of less than 3 years should be kept away unless continuously supervised.
- Adjustable feet should not be removed. The gap between the dryer and the floor should not be reduced with materials such as carpet, wood and tape. This will cause problems with the dryer.
- Always have the installation and repairing procedures carried out by the **Authorised Service**. Manufacturer shall not be held liable for damages that may arise from procedures carried out by unauthorised persons.
- Never wash the dryer by spraying or pouring water onto it! There is the risk of electric shock!

Important instructions for safety and environment

1.1.1 Electrical safety



Electrical safety instructions should be followed while electrical connection is made during the installation.



The appliance must not be supplied through an external switching device, such as a timer, or connected to a circuit that is regularly switched on and off by utility.

- Connect the dryer to a grounded outlet protected by a fuse at the value specified on the type label. Have the grounding installation performed by a qualified electrician. Our company shall not be liable for any damages that will arise when the dryer is used without grounding in accordance with the local regulations.
- The voltage and allowed fuse protection is stated on the type label plate.
- The voltage specified on the type label must be equal to your mains voltage.
- Unplug the dryer when it is not in use.
- Unplug the dryer from the mains during installation, maintenance, cleaning and repair works.
- Do not touch the plug with wet hands! Never unplug by pulling on the cable, always pull out by grabbing the plug.
- Do not use extension cords, multi-plugs or adaptors to connect the dryer to power supply in order to decrease the risk of fire and electric shock.
- Power cable plug must be easily accessible after installation.



Damaged mains cable should be changed by an Authorised Service agent.

Important instructions for safety and environment



If the dryer is faulty, it must not be operated unless it is repaired by an authorised service agent! There is the risk of electric shock!

1.1.2 Product safety



Superheating of the clothes inside of the dryer can occur if you cancel the programme or in the event of a power failure whilst the dryer is running, this concentration of heat can cause self-combustion and fire so always activate the ventilation programme to cool down or quickly remove all laundry from the dryer in order to hang them up and dissipate the heat.



Points to be taken into consideration for fire hazard:

Below specified laundry or items must not be dried in the dryer because of fire hazard.

- Unwashed laundry items
- Items soiled with oil, acetone, alcohol, fuel oil, kerosene, stain removers, turpentine, paraffin or solvents must be washed in hot water with plenty of detergent before being dried in the dryer.

Important instructions for safety and environment



Below specified laundry or items must not be dried in the dryer due to the fire hazard:

- Garments or pillows bolstered with rubber foam (latex foam), shower caps, water resistant textiles, materials with rubber reinforcement and rubber foam pads.
 - Clothing cleaned with industrial chemicals.
- Items such as lighters, matches, coins, metal parts, needle etc. may damage the drum set or may lead to functional problems. Therefore check pockets off the laundry that you will load into your dryer. Never stop your dryer before the programme completes. If you must do this, remove all laundry quickly and lay them out to dissipate the heat.



Clothes that are washed inadequately may ignite on their own and even may ignite after drying ends.

- You must provide enough ventilation in order to prevent gases exiting from devices operating with other types of fuels including the naked flame from accumulating in the room due to the back fire effect.



Clothing that contains metal reinforcements should not be dried in the dryer. Dryer may be damaged if metal reinforcements come loose and break off during drying.



Use softeners and similar products in accordance with the instructions of their manufacturers.



Always clean the lint filter before or after each loading. Never operate the dryer without the lint filter installed.

Important instructions for safety and environment

- Never attempt to repair the dryer by yourself. Do not perform any repair or replacement procedures on the product even if you know or have the ability to perform the required procedure unless it is clearly suggested in the operating instructions or the published service manual. Otherwise, you will be putting your life and others' lives in danger.
- There must not be a lockable, sliding or hinged door that may block the opening of the loading door in the place where your dryer is to be installed.
- Install your dryer in a suitable place that is dry, well ventilated and unlikely to get below 5 degrees Centigrade.
- Make sure that pets do not enter the dryer. Check the inside of the dryer before operating it.
- Do not lean on the loading door of your dryer when it is open, otherwise it may fall over.
- The lint must not be allowed to accumulate around the tumble dryer.
- The tumble dryer is not to be used if industrial chemicals have been used for cleaning.
- Fabric softeners, or similar products, should be used as specified by the fabric softener instructions.
- Exhaust air must not be discharged into a flue which is used for exhausting fumes from appliances burning gas or other fuels.

1.2 Mounting over a washing machine

- A fixing device should be used between the two machines when installing the dryer above a washing machine. The fitting device can be obtained through spare part suppliers.
- Total weight of the washing machine and the dryer -with full load- when they are placed on top of each other

Important instructions for safety and environment

reaches to approx. 180 kilograms. Place the products on a solid floor that has sufficient load carrying capacity!



Washing machine cannot be placed on the dryer. Pay attention to the above warnings during the installation on your washing machine.

Installation Table for Washing Machine and Dryer							
Dryer Depth	Washing Machine Depth						
	62 cm	60 cm	54 cm	50 cm	49 cm	45 cm	40 cm
54 cm	Can be stacked					Can be stacked	Cannot be stacked
60 cm	Can be stacked					Cannot be stacked	

1.3 Intended use

- Dryer has been designed for domestic use. It is not suitable for commercial use and it must not be used out of its intended use.
- Use the dryer only for drying laundry that are marked accordingly.
- The manufacturer waives any responsibility arisen from incorrect usage or transportation.
- Original spare parts will be available to repair the dryer for a period of 10 years.

1.4 Child safety

- Packaging materials are dangerous for the children. Keep packaging materials away from children.
- Electrical products are dangerous for the children. Keep children away from the product when it is operating. Do not let them tamper with the dryer. Use the child-proof lock in order to prevent the children to tamper with the dryer.

Important instructions for safety and environment



Child-proof lock is on the control panel.
(See Child lock)

- Keep loading door closed even when the dryer is not in use.

1.5 Compliance with the WEEE regulation and disposing of the waste product

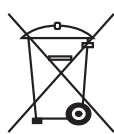

This product complies with EU WEEE Directive (2012/19/EU). This product bears a classification symbol for waste electrical and electronic equipment (WEEE).

This product has been manufactured with high quality parts and materials which can be reused and are suitable for recycling. Do not dispose of the waste product with normal domestic and other wastes at the end of its service life. Take it to the collection center for the recycling of electrical and electronic equipment. Please consult your local authorities to learn about these collection centers.

1.6 Compliance with RoHS Directive:

The product you have purchased complies with EU RoHS Directive (2011/65/EU). It does not contain harmful and prohibited materials specified in the Directive.

1.7 Package information

Packaging materials of the product are manufactured from recyclable materials in accordance with our National Environment Regulations. Do not dispose of the packaging materials together with the domestic or other wastes. Take them to the packaging material collection points designated by the local authorities.

Important instructions for safety and environment

1.8 Technical Specifications



EN	
Height (Min. / Max.)	84,6 cm / 86,6 cm*
Width	59,7 cm
Depth	65,4 cm
Capacity (max.)	8 kg**
Net weight (plastic front door usage)	47 kg
Net weight (glass front door usage)	49,5 kg
Voltage	See type label***
Rated power input	
Model code	

* Min. height: Height with adjustable feet are closed.

Max. height: Height with adjustable feet are opened maximum.

** Dry laundry weight before washing.

*** For the location of the type label on the dryer (**see 2.1 Overview.**)

	Technical specifications of the dryer are subject to specification without notice to improve the quality of the product.
	Figures in this manual are schematic and may not match the product exactly.
	Values stated on markers on the dryer or in the other published documentation accompanying with the dryer are obtained in laboratory in accordance with the relevant standards. Depending on operational and environmental conditions of the dryer, these values may vary.

2 Your Dryer

2.1 Overview

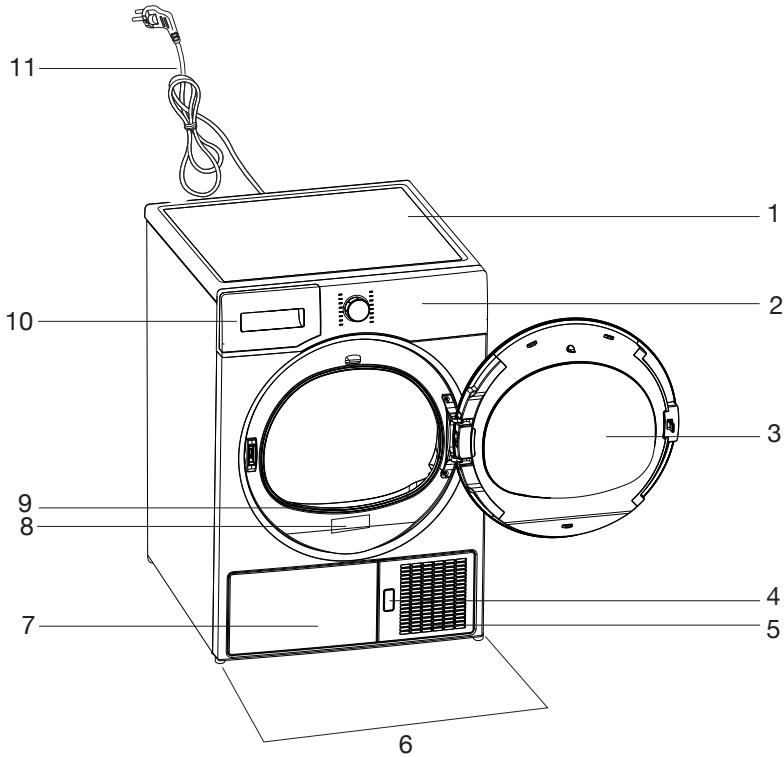

1. Top panel
2. Control panel
3. Loading door
4. Kick plate opening button
5. Ventilation grids
6. Adjustable legs
7. Kick plate
8. Type label
9. Lint filter
10. Water tank drawer
11. Power cord

2.2 Package Contents

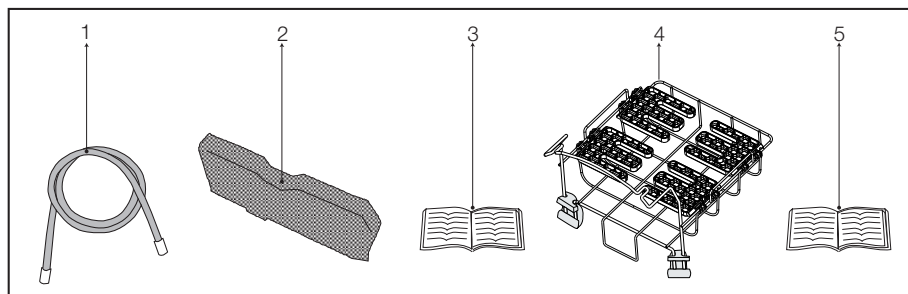

1. Water drain hose *
2. Filter drawer spare sponge*
3. User Manual
4. Drying basket*
5. Drying basket user manual*

*It can be supplied with your machine depending on its model.

3 Installation

Before the calling the nearest Authorized Service for the installation of the dryer, ensure that electrical installation and water drain is appropriate referring to the user's manual. **(See 3.3 Connecting to the drain and 3.5 Electrical connection)** If they are not suitable, contact a qualified electrician and technician to make necessary arrangements.



Preparation of the dryer's location as well as the electrical and waste water installations is under customer's responsibility.



Prior to installation, visually check if the dryer has any defects on it. If the drier is damaged, do not have it installed. Damaged products cause risks for your safety.



Let your dryer wait for 12 hours before starting to use it.

3.1 Appropriate installation location

Install the dryer on a stable and level surface. Dryer is heavy. Do not move it by yourself.

- Operate your dryer in a well ventilated, dust-free environment.
- The gap between the dryer and the surface should not be reduced by the materials such as carpet, wood and tape.
- Do not cover the ventilation grills of the dryer.
- There must not be a lockable, sliding or hinged door that may block the opening of the loading door in the place where your dryer is to be installed.
- Once the dryer is installed, it should stay at the same place where its connections have been made. When installing the dryer, make sure that its rear wall does not touch anywhere (tap, socket, etc.).
- Place the dryer at least 1 cm away from the edges of other furniture.
- Your dryer can be operated at temperatures between +5°C and +35°C. If the operating conditions fall outside of this range, operation of the dryer will be adversely affected and it can get damaged.

- The rear surface of the tumble dryer shall be placed against a wall.



Do not place the dryer on the power cable.

3.2 Removing the transportation safety assembly



Remove the transportation safety assembly before using the dryer for the first time.

- Open the loading door.
- There is a nylon bag inside the drum that contains a piece of styrofoam. Hold it from its section marked with **XX XX**.
- Pull the nylon towards yourself and remove the transportation safety assembly.

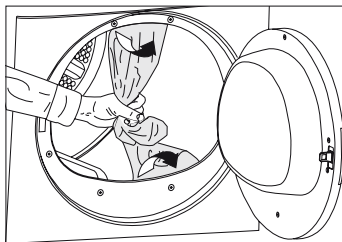

Check that no part of the transportation safety assembly remains inside the drum.

3.3 Connecting to the drain

In products equipped with condenser unit, water accumulates in the water tank during the drying cycle. You should drain accumulated water after each drying cycle. You can directly drain accumulated water through the water drain hose supplied with the product instead of periodically draining the water collected in the water tank.

Installation

Connecting the water drain hose

- 1-2** Pull hose at the behind of the dryer by hand in order to disconnect it from where it is connected. Do not use any tools to remove the hose.
- 3** Connect one end of the drain hose supplied with the dryer to the connection point from where you removed the hose of the product in previous step.
- 4** Connect the other end of the drain hose directly to the wastewater drain or to the washbasin.

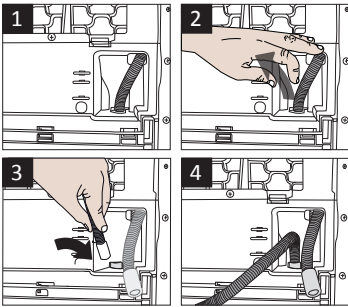

3.4 Adjusting the feet

- In order to ensure that the dryer operates more silently and vibration-free, it must stand level and balanced on its feet. Balance the machine by adjusting the feet.
- Turn the feet to left or right until the dryer stands level and firmly.

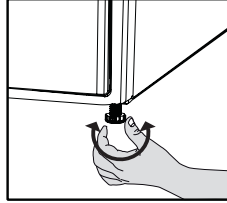

Never unscrew the adjustable feet from their housings.

3.5 Electrical connection

For specific instructions for electrical connection required during installation (see 1.1.1

Electrical Safety)

3.6 Transportation of the dryer

Unplug the dryer before transporting it.

Drain all water that has remained in the dryer.

If direct water drain connection is made, then remove the hose connections.



We recommend carrying the dryer in upright position. If it is not possible to carry the machine in the upright position, we recommend carrying it by tilting towards the right side when looked from the front.



Hose connection should be made in a safe manner. Your drain house will be flooded if the hose comes out of its housing during water discharge.



Water drain hose should be attached to a height of maximum 80 cm.



Make sure that the water drain hose is not stepped on and it is not folded between the drain and the machine.

Installation

3.7 Warnings about sounds



It is normal to hear a metallic noise from the compressor sometimes during operation.

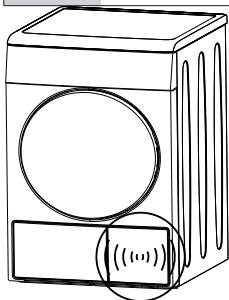

Water collected during operation is pumped to water tank. It is normal to hear pumping noise during this process.

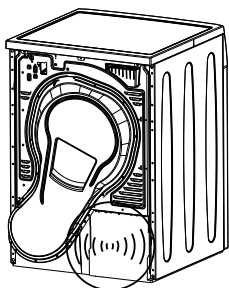

3.8 Changing the illumination lamp

In case an illumination lamp is used in your laundry dryer. To change the Bulb/LED used for illumination of your tumble dryer, call your Authorized Service.

The lamp(s) used in this appliance is not suitable for household room illumination. The intended purpose of this lamp is to assist the user to place laundry in the tumble dryer in a comfortable way. The lamps used in this appliance have to withstand extreme physical conditions such as vibrations and temperatures above 50 °C

4 Electrical Connection

Make sure that you have an earthed power outlet socket rated at 13 amps (minimum).

4.1 Attention!

When installed, the socket must be reachable after installation, or a separate switch (which can disconnect the two poles) must be used in the installation. Check for suitability. For a permanent connection, a master switch with at least 3mm contact clearance and minimum 13 A rating must be used.

4.2 Electrical requirements

Before you insert the plug into the wall socket make sure that the voltage and the frequency shown in the rating label corresponds to your electricity supply.

We recommend that this appliance be connected to the mains supply via a suitable switched and fused socket in a readily accessible position. Should the mains lead of the appliance become damaged or need replacing at any time, it must be replaced by a special purpose made mains lead which can only be obtained from a Authorised Service Agent.



Warning

This appliance must be earthed

If the fitted moulded plug is not suitable for your socket, then the plug should be cut off and an appropriate plug fitted.

The moulded plug on this appliance incorporates a 13A fuse. Should the fuse need to be replaced an ASTA approved BS1362 fuse of the same rating must be used. Do not forget to refit the fuse cover. In the event of losing the fuse cover, the plug must not be used until a replacement fuse cover has been fitted. Colour of the replacement fuse cover must be the same colour as that visible on the pin face of the plug. Fuse covers are available from any good electrical store.

In order to avoid hazards, damaged supply cord should be replaced by the manufacturer, its service agent or similarly qualified people. Built-under installation

This appliance can be installed under a work-top.



Do not operate without the top cover fitted. Risk of injury.



Important

4.3 Fitting a different plug

As the colours of the wires in the mains lead of this appliance may not correspond with the coloured markings identifying the terminals on your plug, proceed as follows:

- 1 Connect the green - yellow or green (earth) wire to the terminal in the plug marked 'E' or with the symbol or coloured green and yellow or green.
- 2 Connect the blue (neutral) wire to the terminal in the plug marked 'N' or coloured black.
- 3 Connect the brown (live) wire to the terminal in the plug marked 'L' or coloured red.

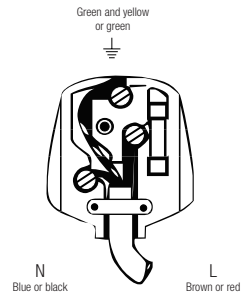

With the alternative plugs a 13A fuse must be fitted either in the plug or adaptor or in the main fuse box. If in doubt contact a qualified electrician.

4.4 Washer/dryer combination

Do not stack washing machine on top of the tumble dryer. This would damage both appliances and guarantees would become void. It is also unsafe to stack an appliance on top of another without using a suitable and approved stacking kit obtained from the manufacturer of the appliances.

- A special stacking kit is required as an optional extra please contact customer service.

5 Preparation

5.1 Laundry suitable for drying in the dryer

Always obey the instructions given on the garment tags. Dry only the laundry having a label stating that they are suitable for drying in a dryer and make sure that you select the appropriate programme.

LAUNDRY DRYING SYMBOLS																					
	Drying Symbols		Suitable for dryer		No Iron		Sensitive / Delicate dry		Do not dry with dryer		Do not dry		Do not dry-clean								
	Drying Settings		At any temperature		At high temperature		At medium temperature		At low temperature		Without heating		Hang to dry		Lay to dry		Hang wet to dry		Lay in shadow to dry		Dry-cleanable
	IRON		Iron -		Iron at high temperature		Iron at medium temperature		Iron at low temperature		Do not iron		Iron without steam	Maximum temperature	200 °C	150 °C	110 °C				

5.2 Laundry not suitable for drying in the dryer



Delicate embroidered fabrics, woolen, silk garments, delicate and valuable fabrics, airtight items and tulle curtains are not suitable for machine drying.

5.3 Preparing laundry for drying

- Laundry may be tangled with each other after washing. Separate the laundry items before placing them into the dryer.
- Dry garments having metal accessories such as zippers, inside out.
- Fasten the zippers, hooks and buckles and button sheets.

5.4 Things to be done for energy saving

Following information will help you use the dryer in an ecological and energy-efficient manner.

- Spin your laundry at the highest speed possible when washing them. Thus, the drying time is shortened and energy consumption is reduced.
- Sort out the laundry depending on their type and thickness. Dry the same type of laundry together. For example thin kitchen towels and table clothes dries earlier than thick bathroom towels.
- Follow the instructions in the user manual for programme selection.
- Do not open the loading door of the machine during drying unless necessary. If you must certainly open the loading door, do not to keep it open for a long time.

Preparation

- Do not add wet laundry while the dryer is in operation
- Clean the lint filter before or after each drying cycle. **(See 7.1 Cleaning Lint Filter / Loading Door Inner Surface)**
- Clean the filter drawer periodically when there is visible air collection on it or when the symbol lights up, if there is a filter drawer cleaning warning symbol «  » available. **(See 7.4 Cleaning the filter drawer)**
- Ventilate the room, where the dryer is located, well during drying.

5.5 Correct load capacity

Follow the instructions in the “Programme selection and consumption table”. Do not load more than the capacity values stated in the table.

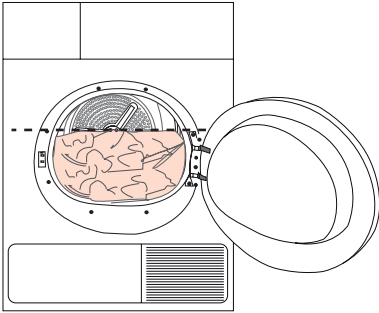

It is not recommended to load the dryer with laundry exceeding the level indicated in the figure. Drying performance will degrade when the machine is overloaded. Furthermore, dryer and the laundry can get damaged.

Following weights are given as examples.

Laundry	Approximate weights (g)*
Cotton quit covers (double)	1500
Cotton quit covers (single)	1000
Bed sheets (double)	500
Bed sheets (single)	350
Large tablecloths	700
Small tablecloths	250
Tea napkins	100
Bath towels	700
Hand towels	350
Blouses	150
Cotton shirts	300
Shirts	250
Cotton dresses	500
Dresses	350
Jeans	700
Handkerchiefs (10 pieces)	100
T-Shirts	125

*Dry laundry weight before washing.

6 Operating the product

6.1 Control Panel

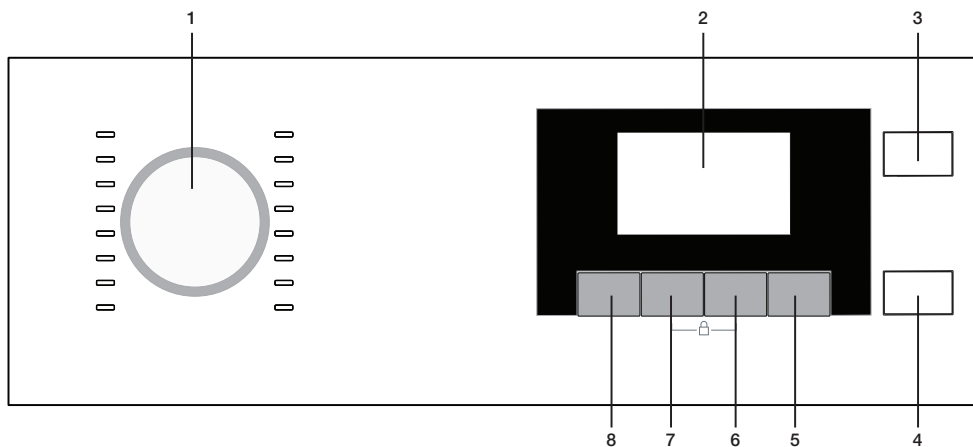

1. Program Selection button
2. Display
3. On-Off button
4. Start/Stand-by button
5. End Time button
6. Rapiddry button
7. Buzzer button
8. Dryness Settings Selection button

6.2 Screen symbols

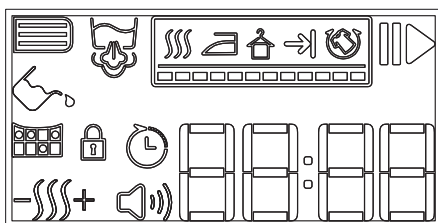

- | | | | |
|--|------------------------------------|--|---------------------------|
| | Buzzer level symbol | | Closet-dry |
| | Evaporator cleaning warning symbol | | Child lock warning symbol |
| | Filter cleaning warning symbol | | End of cycle |
| | Water tank warning symbol | | Anti-crease |
| | Start/hold symbol | | End time |
| | Steam symbol | | Remaining time indicator* |
| | Dryness level | | |
| | Iron-dry | | |

*Time displayed indicates the remaining time to the end of the cycle and this time varies as per the humidity of the laundry.

Operating the product

6.3 Preparing the dryer

Plug in the tumble dryer

Open device door.

Place the laundry into the tub in a slight loosely.

Close the door by pushing.

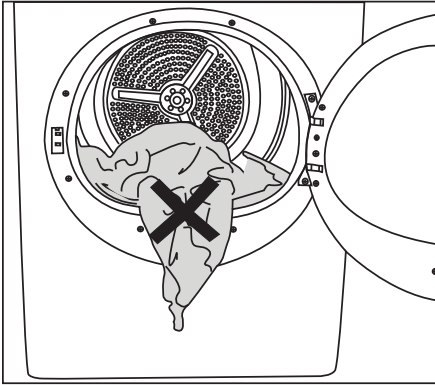

Make sure there is nothing door and the device while closing the door.

Press and hold **On/Off/Cancel** button for 1 second.

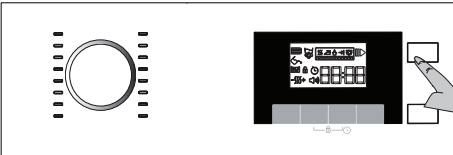

- When dryer is used for the first time, declaration program (cupboard dry cottons) is selected.



Program doesn't start immediately only by pressing the **On/Off/Cancel** button. Start the program with the **On/Off/Cancel** button after program selection.

6.4 Programme selection

Your dryer has 16 different programs.

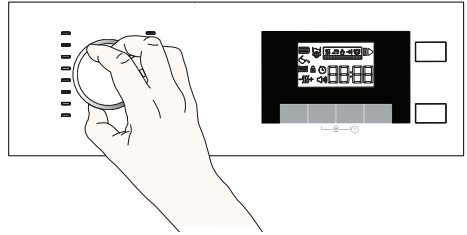

- Select the desired program by turning the program selection button..
- Displayed program selection and consumption chart are based on sorting by preferences of majority of users.

Operating the product

6.5 Programme selection and consumption chart

Programme	Programme Description	Capacity (kg)*	Spin Speed in Washing Machine (rpm)	Drying Time (Min.)	RapiDry (Min.)
Cottons Cupboard Dry	You may dry all your cotton laundry in this program. (T-shirt, pants, pyjamas, baby clothes, underwear, linen, etc.) You can put your laundry in the wardrobe without ironing.	8 / 4	1000	152 / 95	115
Cottons Iron Dry	You may dry your cotton laundry to be ironed in this program to have them slightly damp for ease of ironing. (Shirt, T-shirt, tablecloth, etc.) (Hemden, T-Shirts, Tischdecken usw.)	8	1000	124	95
Cottons Extra Dry	You may dry your thick cotton laundry in this program such as towels, bathrobe, etc. You can put your laundry in the wardrobe without ironing.	8	1000	165	130
Synthetics Cupboard Dry	You may dry all your synthetic laundry in this program. (Shirt, T-shirt, underwear, tablecloth, etc.) You can put your laundry in the wardrobe without ironing.	4	800	75	50
Synthetics Iron Dry	You may dry your synthetic laundry to be ironed in this program to have them slightly damp for ease of ironing. (Shirt, T-shirt, tablecloth, etc.)	4	800	59	34
Jeans	You may dry denim pants, skirts, shirts or jackets in this program.	4	1200	117	85
Sport	Use for drying laundry made out of synthetic, cotton or mixed type of fabrics.	4	1000	105	70
Shirts 30'	Use this programme to make 2 shirts ready for ironing in 30 minutes.	0,5	1200	30	23
BabyProtect	This programme is used for baby clothes that bear machine dryable approval on its label.	3	1000	95	71
Mix	Use this programme to dry non-pigmenting synthetic and cotton laundry items together.	4	1000	110	75

Operating the product

Bedding	Dry fiber quilts with 'machinedryable' label only. Make sure you are loading the quilt in the correct way to avoid damages on the machine and the quilt. Take out the quilt cover before loading the quilt in the machine. Fold the quilt in two before loading. - Do not load more than 1 doublesize fiber quilt (200x200 cm). Do not dry items containing cotton such as quilts, pillows and etc. - Do not dry items other than quilts such as carpets, rugs or mats. Permanent damage may arise in your machine.	2,5	1000	120	-
Night	In this programme the level of noise emitted to the environment will be the lowest. Volume level will be fifty percent lower with respect to the 'wardrobe dry for cottons' programme.	8	1000	240	
Delicates	You may dry your delicate laundry or laundry with hand wash symbol (silk blouses, thin underwear, etc.) at low temperature in this program.	2	600	50	
WoolProtect	Use this programme to dry woolen garments such as jumpers that are washed according to the instructions. It is recommended that garments would be removed at the end of the programme.	1,5	600	148	
Freshen Up	It just provides airing for 10 minutes without any hot air. You can air the cotton and linen laundry that are kept closed for a long time, and eliminate the odour in them.	-	-	10	
Timer programmes	You may select from time programs between 10 and 160 minutes to achieve the desired drying level at low temperature. In this program, tumble drier's operation lasts for the set time independently from the dryness of laundry. In order to select any drying time, you need to press the timer selection "⌚" key.	-	-	-	

* Weight of dry laundry before washing

Operating the product

Energy consumption values					
Programs	Capacity (kg)	Spin speed in washing machine (rpm)	Approximate amount of remaining humidity	Energy consumption value kWh	RapiDry kWh
Cottons linen Ready to wear**	8 / 4	1000	% 60	1,43 / 0,84	2,33
Cottons Ready to iron	8	1000	% 60	1,15	1,99
Synthetics Ready to wear	4	800	% 40	0,51	0,87
Power consumption of the off-mode for the standart cotton programme at full load, PO (W)				0,1	
Power consumption of the left-on mode for the standart cotton programme at full load, PL (W)				1,0	
Contains fluorinated greenhouse gases covered by the Kyoto Protocol. Hermetically sealed. R134a / 0,52 kg - GWP:1430 - 0,744 tCO _{2e}					



When the program ends for not having wrinkles on your delicate laundry, take out your laundry immediately and hang them.



The wool drying cycle of this machine has been approved by The Woolmark Company for the drying of machine washable wool products provided that the products are washed and dried according to the instructions on the garment label and those issued by the manufacturer of this machine. The Woolmark symbol is a Certification mark in many countries. M1729.



„Cotton cupboard dry programme“ used at full and partial load is the standard drying programme to which the information in the label and the fiche relates, that this programme is suitable for drying normal wet cotton laundry and that it is the most efficient programme in terms of energy consumption for cotton.



To get better results from drying machine programs, your laundry should be washed with suitable program in your washing machine and wrung with recommended wringing speed.



Shirt might remain slightly damp at the end of the program. It is recommended not to leave the shirts inside the drying machine.

** : Energy Label standard program (EN 61121:2012)

All the values on the chart are identified according to EN 61121:2012 standard. Consumption values may vary from the valued in the chart depending on laundry type, wringing speed, ambient conditions and voltage levels.

Operating the product

6.6 RapiDry

This application is available for all programmes highlighted with dark colour on the control panel.

For example in case of “wardrobe ready for cotton” the usual programme duration is 2:32, the ExpressDy feature reduces the required time to 1:55.

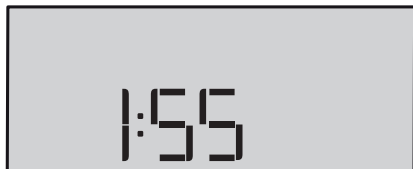
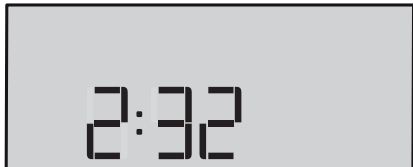

6.7 Auxiliary functions

Audible warning

 Machine makes an audible warning when the program is completed. To adjust the sound level, use the Sound Warning Level button.

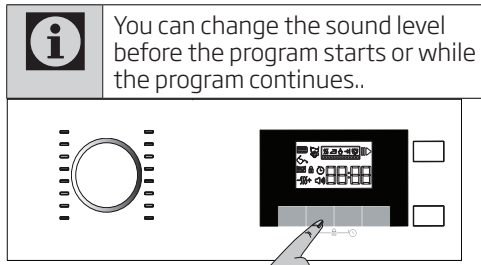

Volume level low

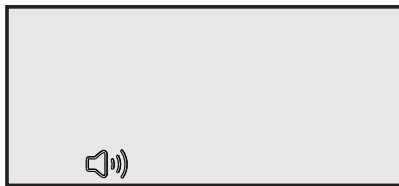

Volume level high

Dryness settings selection

 Dryness settings button is used for adjusting to desired dryness. Program time may change depending on the selection.

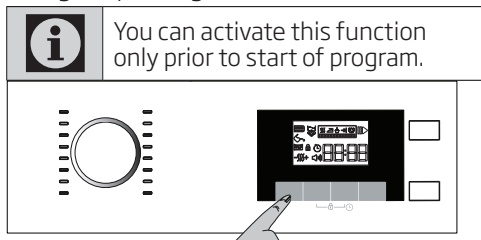

Operating the product



Drying level damp



Drying level normal



Drying level extra

6.8 Warning symbols

	Warning symbols may vary depending on the model of your machine.
----------------------------------------------------------------------------------	------------------------------------------------------------------

Fibre filter cleaning

When the program is completed, the warning symbol for filter cleaning turns on.

	For detailed information, See 6 Maintenance and cleaning.
------------------------------------------------------------------------------------	-----------------------------------------------------------

	If filter cleaning symbol constantly flashes See.7 Troubleshooting.
------------------------------------------------------------------------------------	---------------------------------------------------------------------

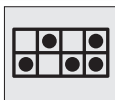

Emptying the water tank

When the program is completed, the warning symbol to empty the water tank turns on.

	For detailed information, See 6 Maintenance and cleaning.
-----------------------------------------------------------------------------------	-----------------------------------------------------------

If the water tank fills up while the program continues, the warning symbol starts flashing and the machine goes into stand-by. In this case, empty the water tank and start the program by pressing the Start / Stand-by button. Warning symbol turns off and program resumes.



Cleaning the filter drawer

Warning symbol flashes to remind that the filter drawer needs to be cleaned.

	For detailed information, See 6 Maintenance and cleaning.
-----------------------------------------------------------------------------------	-----------------------------------------------------------



Loading cover is open

If loading cover of the dryer is open while drying, Stand-by symbol turns on and program progress symbol flashes.

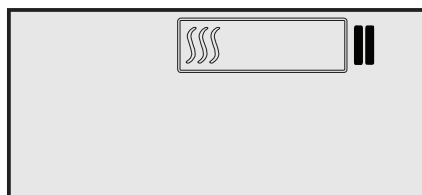

End time

You can delay the end time of the program up to 24 hours with end time function.

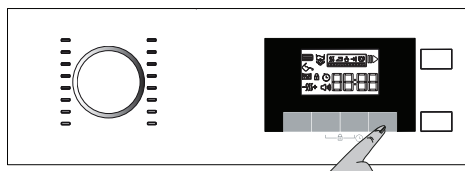

- Open the loading door and place the laundry.

Operating the product

- Select drying program, spin cycle and if needed, additional functions.
- Press the End Time selection button and set the delay time you wish. End Time symbol turns on. (When pressed and hold the button, End Time proceeds non-stop).
- Press the Start / Stand-by button. End time countdown starts and Start symbol turns on. ":" Separator in the middle of displayed delay time flashes.

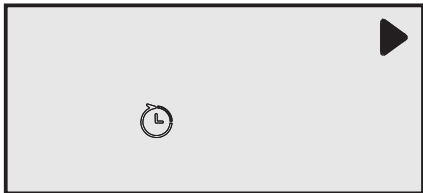

 You can add or remove laundry within end time. End Time symbol will turn off at the end of countdown, drying starts and duration of program is displayed. Displayed time is the sum of normal drying time and end time.

Changing the end time

If you want to change the duration during the countdown:

- Press the **On/Off/Cancel** button for 3 seconds to cancel the program. Turn on the machine again and repeat the Delay Setting process for the duration you wish.
- When your machine is turned on for the first time, it turns on with the declaration program (cotton wardrobe dry).

Canceling the end time function

If you want to cancel the end time countdown and start the program immediately:

- Press the **On/Off/Cancel** button for 3 seconds to cancel the program.
- Press the **On/Off/Cancel** button to start you previously selected program.

6.9 Starting the program

Press the  Start/Stand-by button to start the program.

Indicating start of the program, Start symbol turns on, ":" separator in the middle of remaining time keeps flashing. Program Progress Symbol turns on.

6.10 Program progress status

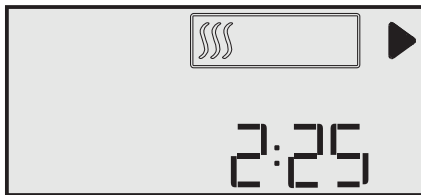

6.11 Child Lock

The machine has a child lock which prevents the program flow from being interrupted when the buttons are pressed during a program. To activate the child lock

- Press and hold time programs and audio warning buttons for 3 seconds.
- When the child lock is activated, the lock symbol on the screen turns on.

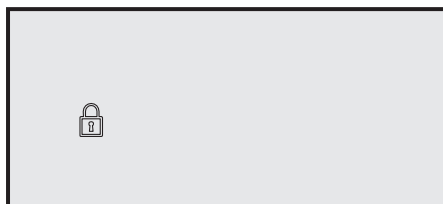
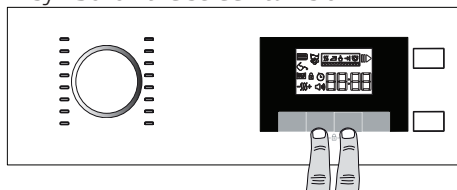

- When the child lock is activated, all buttons on the panel except the On/Off/Cancel and Child Lock buttons are deactivated.
- When the child lock is activated, indicator symbols don't change if the position of Program Selection button is changed. When Program Selection button is turned on and function buttons are pressed, the letters "CL" flashes on the screen.

Operating the product



- The child lock has to be deactivated to be able to start a new program after the current program is finished or to be able to interfere with the program.

To Deactivate The Child Lock:

- Press and hold the child lock button for 3 seconds.
- Child lock deactivates when the dryer is turned off and on by the **On/Off/Cancel** button.

6.12 Changing the program after it is started

You can change the program you selected to dry your laundry with a different program after the machine starts running.

- For example, to select Extra Dry instead of Iron Dry, pause the program by pressing the Start / Stand-by button.
- Select the Extra Dry program using the Program Selection button.
- Press the Start/Stand-by button to start the program.

Adding and removing clothes during stand-by

- If you want to add or remove clothes to/from the machine after the drying program starts:
- Press the Start/Stand-by button to put the machine in Stand-by state. The drying operation stops.
- Open the loading door while in Stand-by state, and close the door after you remove or add laundry.
- Press the Start/Stand-by button to start the program.



Adding laundry after the drying operation starts may cause the dried laundry inside the machine to mix with wet laundry and leave the laundry damp at the end of operation.



Adding or removing laundry during drying may be repeated as many times as you wish. But this operation continuously interrupts the drying operation, and thus increases program duration and energy consumption. So, it is recommended to add laundry before the program starts.



If a new program is selected by turning the program selection knob while the machine is in stand-by; the running program terminates and new program information is displayed on the screen.



WARNING: Do not touch the inner surface of the drum while adding or removing clothes during a continuing program. The drum surface is hot.

6.13 Cancelling the program

If you want to cancel the program and terminate the drying operation for any reason after the machine starts running, keep the **On/Off/Cancel** button pressed for 3 seconds.



WARNING: The inside of the machine shall be extremely hot when you cancel the program during machine operation, so run the ventilation program to allow it to cool down.



Operating the product

6.14 End of programme

When the program ends, the Fibre Filter Cleaning and Water Tank warning symbols on the program observation indicator turn on. Loading door may be opened and machine becomes ready for another run.

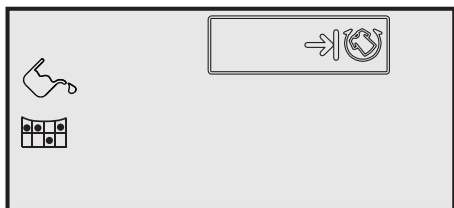
To turn off the machine, press the **On/Off/Cancel** button.



	Wrinkle Prevention function activates the 2 hour-Wrinkle Prevention program if laundry isn't taken out of machine after completion of the program.
	Clean the fibre filter after each drying. See 7.1 Cleaning Lint Filter / Loading Door Inner Surface
	Empty the water tank after each drying. See 7.3 Draining the water tank

7 Maintenance and cleaning

Loading Door Inner Surface

The hair and fibres that are separated from the laundry during drying process is collected by the Fibre Filter.



Fibres are formed during wearing and washing clothes



After each drying cycle, clean the fibre filter and the inner surface of the loading door



You can clean the filter slot with a vacuum cleaner

To clean the fibre filter:

- Open the loading door.
- Hold the first part (inner filter) of the two part fibre filter and remove it by pulling it upwards.

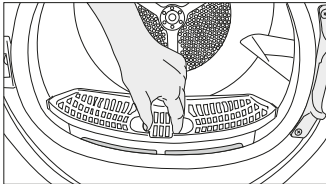

- Collect the hair, fibres and cotton balls with hand or with a soft cloth.
- Remove the second part (outer filter) by pulling it upwards.

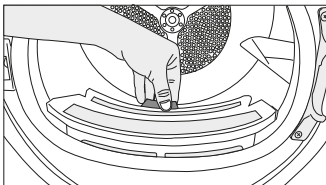

Ensure that hair, fibre and cotton balls do not fall into the slot where the filters are installed

- Open both fibre filters (inner and outer filters) remove the hair, fibre, cotton balls with your damp hand or a vacuum cleaner or a cloth.

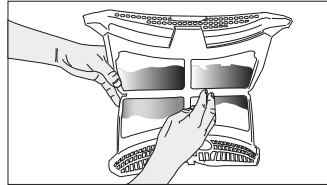
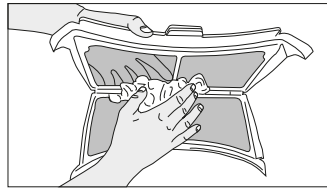

- Clean both filters under water running in reverse direction of fibre accumulation or with a soft brush. Dry the filter before placing it back.

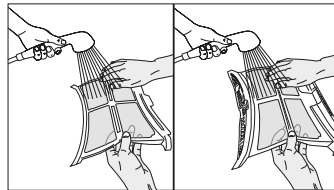

- Insert the fibre filters on one another and place it back in its place.

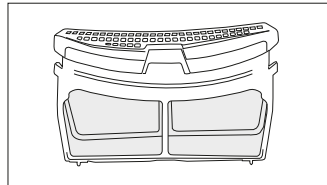

- Clean the loading door interior and its washer with a soft damp cloth.

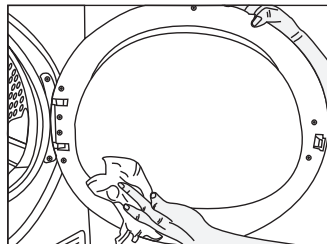

Maintenance and cleaning

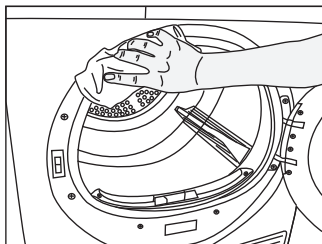

7.2 Cleaning the sensor

There are dampness sensors in the dryer that detect whether the laundry is dry or not. To clean the sensors:

- Open the loading door of the dryer.
- Allow the machine to cool down if it is still hot due to the drying process.
- Wipe the metal surfaces of the sensor with a soft cloth, dampened with vinegar and dry them.



Clean metal surfaces of the sensors 4 times a year.



Do not use metal tools when cleaning metal surfaces of the sensors.



Never use solvents, cleaning agents or similar substances for cleaning due to the risk of fire and explosion!

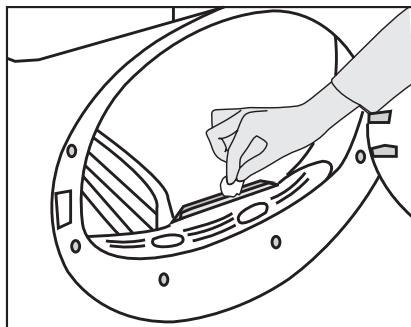

7.3 Draining the water tank

Dampness of the laundry is removed and condensed during drying process and the water that arise accumulates in the water tank. Drain the water tank after each drying cycle.



Condensed water is not drinkable!



Never remove the water tank when the program is running!

If you forget to drain the water tank, the machine will stop during the subsequent drying cycles when the water tank is full and the Water Tank warning symbol will flash. If this is the case, drain the water tank and press **Start / Pause** button to resume the drying cycle.

To drain the water tank:

Pull the drawer and remove the water tank carefully.

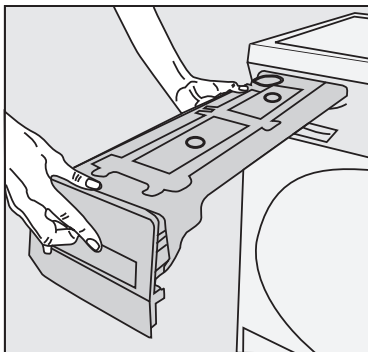

- Drain the water in the tank.

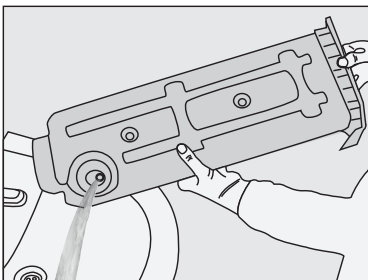

Maintenance and cleaning

- If there is lint accumulation in the funnel of the water tank, clean it under running water.
- Place the water tank into its seat.



If the direct water draining is used as an option, there is no need to empty the water tank.

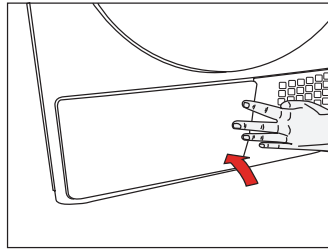

7.4 Cleaning the evaporator

The hair and fibres that are not caught by the fibre filter goes to the fins of the evaporator behind the toe board and accumulates here. If the evaporator '🌀' icon is flashing or in 6 month periods, clean the evaporator. Open the toe board by pressing on it.

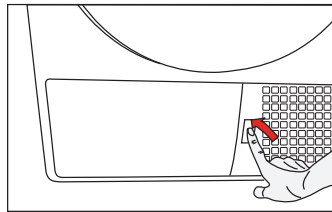

- To open the air routing door, move the release latch.

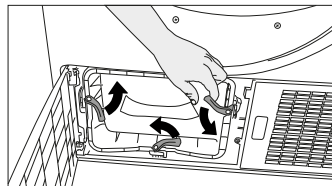

- Clean the fibres on the evaporator with a damp cloth / vacuum cleaner with a brush by moving upwards and downwards.

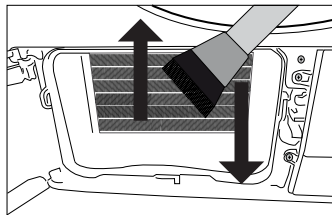

- After the cleaning process is completed, place the air router door to its place, move the latches to close it and close the toe board.



You can clean by hand, provided you wear protective gloves. Do not try to clean with bare hands. Evaporator fins may damage your hands

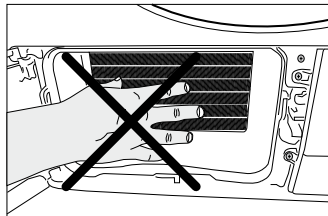

Cleaning by left to right movements may damage the evaporator fins. This may lead to drying issues

8 Troubleshooting

Drying operation takes too long.

- Fibre filter (interior and exterior filter) pores may be clogged. >>> Wash the fibre filters with warm water and dry.
- Evaporator front side may be clogged. >>> Clean the front side of the evaporator.
- The ventilation grills in front of the machine may be closed. >>> Remove any object in front of the ventilation grills that blocks air.
- Ventilation may be inadequate because the area the machine is installed in is too small. >>> Open the door or windows to prevent the room temperature from rising very high.
- A lime layer may have accumulated on the humidity sensor. >>> Clean the humidity sensor.
- Excessive amount of laundry might be loaded. >>> Do not load the drying machine excessively.
- Laundry might not have been wrung adequately. >>> Perform a higher speed wringing on the washing machine.

Clothes come out damp after drying.



Laundry that comes out at the end of the drying process feels more humid than it actually is.

- A program not suitable for the laundry type may have been used. >>> Check the maintenance labels on the clothes and select a program suitable for the clothes' type or use time programs as extra.
- Fibre filter (interior and exterior filter) pores may be clogged. >>> Wash the filters with warm water and dry.
- Evaporator front side may be clogged. >>> Clean the front side of the evaporator.
- Excessive amount of laundry might be loaded. >>> Do not load the drying machine excessively.
- Laundry might not have been wrung adequately. >>> Perform a higher speed wringing on the washing machine.

Drying machine does not turn on or program cannot be started. Drying machine does not run after it is configured.

- Power plug might be unplugged. >>> Make sure the power cord is plugged in.
- Loading door might be open. >>> Ensure that the loading door is properly closed.
- A program might not be set or Start / Pause / Cancel button might not be pressed. >>> Check that the program is set and it is not in Pause position..
- Child lock may be activated. >>> Turn off the child lock.

Program terminated prematurely for no reason.

- Loading door might be closed completely. >>> Ensure that the loading door is properly closed.
- There might be a power outage. >>> Press the Start / Pause / Cancel button to start the program.
- Water tank may be full. >>> Empty the water tank.

Clothes have shrunk, hardened or spoiled.

- A program not suitable with the laundry type might have been used. >>> Check the maintenance labels on the clothes and select a program suitable for the clothes.

Troubleshooting

Water drips from the loading door.

- Fibres might have gathered on the inner sides of the loading door and the loading door gasket. >>> Clean the inner surfaces of the loading door and the loading door gasket surfaces.

Loading door opens by itself.

- Loading door might be closed completely. >>> Push the loading door until the closing sound is heard.

Water tank warning symbol is on/flashing.

- Water tank may be full. >>> Empty the water tank.
- Water discharge hose might have collapsed. >>> If the product is connected directly to the water drain check the water discharge hose.

The lighting inside the drying machine does not turn on. (In models with lamp)

- The drying machine might not have been turned on using On/Off button. >>> Check that the drying machine is turned on.
- Lamp might be malfunctioning. >>> Contact Authorized Service to replace the lamp.

Anti-crease icon is lit.

- Anti-Crease mode that prevents the laundry in the drier to crease may be activated. >>> Turn the drier off and remove the laundry.

Fibre filter cleaning icon is lit.

- Fibre filter (interior and exterior filter) may be unclean. >>> Wash the filters with warm water and dry..
- A layer may be formed on the fibre filter pores that leads to clogging. >>> Wash the filters with warm water and dry.
- Fibre filters may not be inserted. >>> Insert the interior and exterior filters to their places.

An audible warning is heard from the machine

- Fibre filters may not be inserted. >>> Insert the interior and exterior filters to their places.

Evaporator warning icon is flashing.

- Evaporator front side may be clogged with fibres. >>> Clean the front side of the evaporator.
- Fibre filters may not be inserted. >>> Insert the interior and exterior filters to their places.

The lighting inside the drying machine turns on. (In models with lamp)

- If the drying machine is plugged to the power outlet, the On/Off button is pressed and the door is open; the light turns on. >>> Unplug the drying machine or bring the On/Off button to Off position.



If the problem persists after following the instructions in this section, contact your vendor or an Authorized Service. Never try to repair your product yourself.

9 Service

Please keep your purchase receipt or other proof of purchase in a safe place; you will need to have it should the product require attention under guarantee.

You should also complete the details below; it will help us assist you when requesting service. (The model number is printed on the Instruction Booklet and the serial number is printed on the Rating Label affixed to the appliance)

Model No:

Serial No:

Retailer:

Date of purchase:

Republic of Ireland

All Refrigeration, 01 862 3411

All Cookers

Washing Machines & Dryers, Tumble Dryers
Dishwashers

Before requesting service please check the trouble-shooting guide in the Operating Instructions as a charge may be levied where no fault is found even though your product may still be under guarantee.

Service once the manufacturers guarantee has expired.

If you have purchased an extended guarantee please refer to the instructions contained within the extended guarantee agreement document. Otherwise please call the appropriate number above where service can be obtained at a charge.

Should you experience any difficulty in obtaining service please contact the Customer Help-Line.

Tel: 0845 600 4911

For service under guarantee simply telephone the appropriate number below.

UK Mainland & Northern Ireland

Fridges & Freezers 0345 600 4903 or 0845 600 4903

Electric Cookers 0345 600 4902 or 0845 600 4902

Gas & Dual Fuel Cookers

0345 600 4905 or 0845 600 4905

Washing Machines & Tumble Dryers
0345 600 4906 or 0845 600 4906

PRODUCT FICHE

Complying Commission Delegated Regulation (EU) No 392/2012

Supplier name or trademark		Beko
Model name		DPHR8PB561W
Rated capacity (kg)		8
Type of Tumble Dryer	Air Vented	-
	Condenser	•
Energy efficiency class ⁽¹⁾		A+++
Annual Energy Consumption (kWh) ⁽²⁾		176
Type of Control	Automatic	•
	Non-automatic	-
Energy consumption of the standard cotton programme at full load (kWh)		1,43
Energy consumption of the standard cotton programme at partial load (kWh)		0,84
Power consumption of the off-mode for the standard cotton programme at full load, P ₀ (W)		0,1
Power consumption of the left-on mode for the standard cotton programme at full load, P _L (W)		1,0
The duration of the left on mode (min)		30
Standard cotton programme ⁽³⁾		
Programme time of the standard cotton programme at full load, T _{dy} (min)		152
Programme time of the standard cotton programme at partial load, T _{dy1/2} (min)		95
Weighted programme time of the standard cotton programme at full and partial load (T _w)		119
Condensation efficiency class ⁽⁴⁾		A
Average condensation efficiency of the standard cotton programme at full load, C _{dy}		91%
Average condensation efficiency of the standard cotton programme at partial load, C _{dy1/2}		91%
Weighted condensation efficiency of the standard cotton programme at full load and partial load, C _t		91%
Sound power level for the standard cotton programme at full load ⁽⁵⁾		66
Built-in		-

• : Yes - : No

(1) Scale from A+++ (most efficient) to D (least efficient)

(2) Energy consumption based on 160 drying cycles of the standard cotton programme at full and partial load, and the consumption of the low-power modes. Actual energy consumption per cycle will depend on how the appliance is used.

(3) "Cotton cupboard dry programme" used at full and partial load is the standard drying programme to which the information in the label and the fiche relates, that this programme is suitable for drying normal wet cotton laundry and that it is the most efficient programme in terms of energy consumption for cotton

(4) Scale from G (least efficient) to A (most efficient)

(5) Weighted average value — L_{WA} expressed in dB(A) re 1 pW

Guarantee

Your new product is guaranteed against the cost of breakdown repairs for twelve months from the date of the original purchase.

What is covered?

- Repairs necessary as a result of faulty materials, defective components or manufacturing defect.
- The cost of functional replacement parts, but excluding consumable items.
- The labour costs of a approved repairer to carry out the repair.

What is not covered?

- Transit, delivery or accidental damage or misuse and abuse.
- Cabinet or appearance parts, including knobs, flaps, handles or container lids.
- Accessories or consumable items including but not limited to, ice trays, scrapers, cutlery baskets, filters and light bulbs.
- Repairs required as a result of unauthorised repair or inexperienced installation that fails to meet the requirements contained in the user instruction book.
- Repairs to products used on commercial or non-residential household premises.
- Loss of frozen food in freezers or fridge/freezers. (Food loss insurance is often included within your household contents insurance policy, or may be available separately from your retailer).

Important notes

- Your product is designed and built for domestic household use only.
- The guarantee will be void if the product is installed or used in commercial or non-residential domestic household premises.
- The product must be correctly installed, located and operated in accordance with the instructions contained in the User Instructions Booklet provided.
- Professional installation by a qualified Electrical Domestic Appliance Installer is recommended for all Washing Machines, Tumble Dryers, Dishwashers, Dryers and Electric Cookers
- Gas Cookers must only be installed by a Gas safe registered Gas Installer.
- The guarantee is given only within the boundaries of the United Kingdom and the Republic of Ireland.
- The guarantee is applicable only to new products and is not transferable if the product is resold.
- Disclaims any liability for incidental or consequential damages.
- The guarantee does not in anyway diminish your statutory or legal rights.

Beko plc, Beko House, 1 Greenhill Crescent, Watford, WD18 8QU

Tel: 0845 6004911

Email: service@beko.co.uk

Fax: 0845 6004922

www.beko.co.uk

Free Manuals Download Website

<http://myh66.com>

<http://usermanuals.us>

<http://www.somanuals.com>

<http://www.4manuals.cc>

<http://www.manual-lib.com>

<http://www.404manual.com>

<http://www.luxmanual.com>

<http://aubethermostatmanual.com>

Golf course search by state

<http://golfingnear.com>

Email search by domain

<http://emailbydomain.com>

Auto manuals search

<http://auto.somanuals.com>

TV manuals search

<http://tv.somanuals.com>