

Refrigerator

User manual

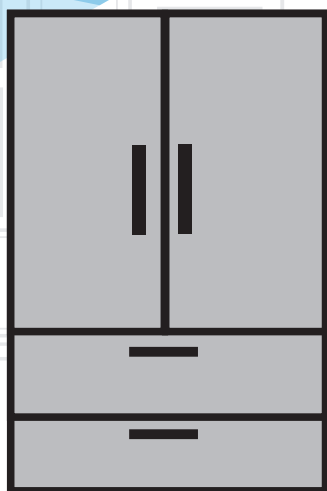

GNE60520X
GNE60520DX
GRNE60520DB

EN |

beko

Please read this manual first!

Dear Customer,

We hope that your product, which has been produced in modern plants and checked under the most meticulous quality control procedures, will provide you with effective service.

For this, we recommend you to carefully read the entire manual of your product before using it and keep it at hand for future references.





The user manual will help you use the product in a fast and safe way.

- Read the manual before installing and operating your product.
- Follow the instructions, especially those for safety.
- Keep the manual in an easily accessible place as you may need it later.
- Besides, read also the other documents provided with your product.

Please note that this manual may be valid for other models as well.

Symbols and their descriptions

This instruction manual contains the following symbols:



	Important information or useful usage tips.
	Warning against dangerous conditions for life and property.
	Warning against electric voltage.
	Packaging materials of the product are manufactured from recyclable materials in accordance with our National Environment Regulations.

1. Safety and environment instructions	3	4 Preparation	17
1.1. General safety	3	4.1. What to do for energy saving...17	
1.1.1 HC warning	5	4.2. First use	17
1.1.2 For models with water dispenser	6		
1.2. Intended use.....	6	5 Using the product	18
1.3. Child safety	7	5.1. Indicator panel.....	18
1.4. Compliance with WEEE Directive and Disposing of the Waste Product.	7	5.2. Zero degree compartment	26
1.5. Compliance with RoHS Directive	7	5.3. Vegetable bin	26
1.6. Package information	7	5.4. Blue light.....	26
		5.5. Description and cleaning of odour filter.....	26
		5.6. Telescopic drawer	27
2 Refrigerator	8	5.7. Ionizer	27
		5.8. Ice box	27
3 Installation	9	5.9. Ice maker.....	27
3.1. Right place for installation	9	5.10.Movable middle section	28
3.2. Attaching the plastic wedges ...	9	5.11.Ice container	28
3.3. Adjusting the feet	10	5.12.Freezing fresh food.....	29
3.4. Power connection	10	5.13.Recommendations for storing frozen foods.....	29
3.5. Water connection	10	5.14.Deep freezer details.....	29
3.6. Connecting water hose to the product	11	5.15.Placing the food	30
3.7. Connecting to water mains	11	5.16.Door open alert.....	30
3.8. For products using water carboy	12	5.17.Interior light	30
3.9 Water filter.....	13		
3.9.1. Fixing external filter on the wall (Optional)	13	6 Maintenance and Cleaning	31
3.9.2. Internal filter	15	6.1. Preventing Bad Odour.....	31
		6.2. Protecting Plastic Surfaces	31
		7 Troubleshooting	32

1. Safety and environment instructions

This section provides the safety instructions necessary to prevent the risk of injury and material damage. Failure to observe these instructions will invalidate all types of product warranty.

Intended use

	WARNING: Keep ventilation openings, in the appliance enclosure or in the built-in structure, clear of obstruction.
	WARNING: Do not use mechanical devices or other means to accelerate the defrosting process, other than those recommended by the manufacturer.
	WARNING: Do not damage the refrigerant circuit.



WARNING:

Do not use electrical appliances inside the food storage compartments of the appliance, unless they are of the type recommended by the manufacturer.

1.1. General safety

- This appliance can be used by children aged from 8 years and above and persons with reduced physical, sensory or mental capabilities or lack of experience and knowledge if they have been given supervision or instruction concerning use of the appliance in a safe way and understand the hazards involved. Children shall not play with the appliance.
- In case of malfunction, unplug the device.
- After unplugging, wait at least 5 minutes before plugging in again.
- Unplug the product when not in use.

Safety and environment instructions

- Do not touch the plug with wet hands! Do not pull the cable to plug off, always hold the plug.
- Do not plug in the refrigerator if the socket is loose.
- Unplug the product during installation, maintenance, cleaning and repair.
- If the product will not be used for a while, unplug the product and remove any food inside.
- Do not use the product when the compartment with circuit cards located on the upper back part of the product (electrical card box cover) (1) is open.

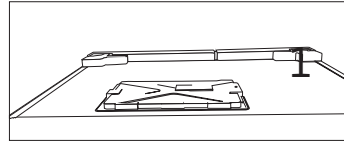
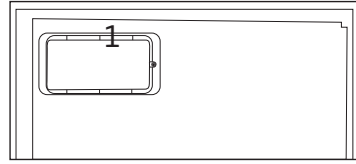

- Do not use steam or steamed cleaning materials for cleaning the refrigerator and melting the ice inside. Steam may contact the electrified areas and cause short circuit or electric shock!
- Do not wash the product by spraying or pouring water on it! Danger of electric shock!
- In case of malfunction, do not use the product, as it may cause electric shock. Contact the authorised service as soon as possible.
- Plug the product into an earthed socket. Earthing must be done by a qualified electrician.
- If the product has LED type lighting, contact

Safety and environment instructions

the authorised service for replacing or in case of any problem.

- Do not touch frozen food with wet hands! It may adhere to your hands!
- Do not place liquids in bottles and cans into the freezer compartment. They may burst.
- Place liquids in upright position after tightly closing the lid.
- Do not spray flammable substances near the product, as it may burn or explode.
- Do not keep flammable materials and products with flammable gas (sprays, etc.) in the refrigerator.
- Do not place containers holding liquids on top of the product. Splashing water on an electrified part may cause electric shock and risk of fire.
- Exposing the product to rain, snow, sunlight and wind will cause electrical danger. When relocating the product, do not pull by holding the door handle. The handle may come off.

- Take care to avoid trapping any part of your hands or body in any of the moving parts inside the product.
- Do not step or lean on the door, drawers and similar parts of the refrigerator. This will cause the product to fall down and cause damage to the parts.
- Take care not to trap the power cable.

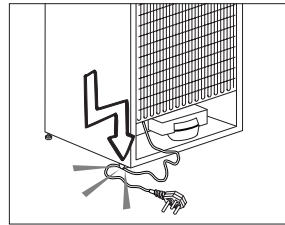

1.1.1 HC warning

If the product comprises a cooling system using R600a gas, take care to avoid damaging the cooling system and its pipe while using and moving the product. This gas is flammable. If the cooling system is damaged, keep the product away from sources of fire and ventilate the room immediately.

Safety and environment instructions



The label on the inner left side indicates the type of gas used in the product.

1.1.2 For models with water dispenser

- Pressure for cold water inlet shall be maximum 90 psi (6.2 bar). If your water pressure exceeds 80 psi (5.5 bar), use a pressure limiting valve in your mains system. If you do not know how to check your water pressure, ask for the help of a professional plumber.
- If there is a risk of water hammer effect in your installation. Consult a plumber.
- Do not install on the hot water inlet. Take precautions against of the risk of freezing of the hoses. Water temperature operating interval shall be 33°F (0.6°C) minimum and 100°F (38°C) maximum.
- Use drinking water only.

1.2. Intended use

- This product is designed for home use. It is not intended for commercial use.
- The product should be used to store food and beverages only.
- Do not keep sensitive products requiring controlled temperatures (vaccines, heat sensitive medication, medical supplies, etc.) in the refrigerator.
- The manufacturer assumes no responsibility for any damage due to misuse or mishandling.

Safety and environment instructions

1.3. Child safety

- Keep packaging materials out of children's reach.
- Do not allow the children to play with the product.
- If the product's door comprises a lock, break off the lock when eventually disposing of the product.

1.4. Compliance with WEEE Directive and Disposing of the Waste Product

This product complies with EU WEEE Directive (2012/19/EU). This product bears a classification symbol for waste electrical and electronic equipment (WEEE).

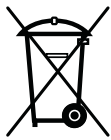

This product has been manufactured with high quality parts and materials which can be reused and are suitable for recycling. Do not dispose of the waste product with normal domestic and other wastes at the end of its service life. Take it to the collection center for the recycling of electrical and electronic equipment. Please consult your local authorities to learn about these collection centers.

1.5. Compliance with RoHS Directive

- This product complies with EU WEEE Directive (2011/65/EU). It does not contain harmful and prohibited materials specified in the Directive.

1.6. Package information

- Packaging materials of the product are manufactured from recyclable materials in accordance with our National Environment Regulations. Do not dispose of the packaging materials together with the domestic or other wastes. Take them to the packaging material collection points designated by the local authorities.

2 Refrigerator

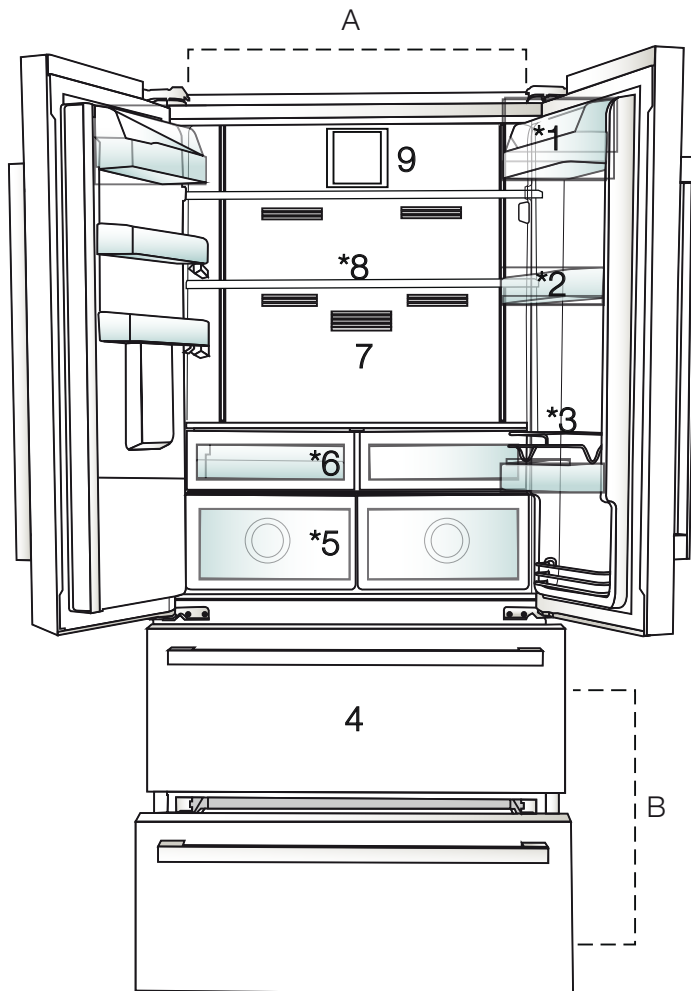

A- Cooler compartment

B- Freezer compartment

1. Butter-cheese shelf

2. Door shelves

3. Shelter wire

4. Frozen food storing compartments

5. Vegetable bins

6. Breakfast compartment

7. Odour filter

8. Adjustable glass shelves

9. Fan



*Optional: Figures in this user guide are schematic and may not exactly match your product. If your product does not comprise the relevant parts, the information pertains to other models.

3 Installation

3.1. Right place for installation

Contact the authorised Service for the product's installation. To ready the product for installation, see the information in the user guide and make sure the electric and water utilities are as required. If not, call an electrician and plumber to arrange the utilities as necessary.



WARNING: The manufacturer assumes no responsibility for any damage caused by the work carried out by Unauthorised persons.



WARNING: The product's power cable must be unplugged during installation. Failure to do so may result in death or serious injuries!



WARNING: If the door span is too narrow for the product to pass, remove the door and turn the product sideways; if this does not work, contact the Unauthorised service.

- Place the product on a flat surface to avoid vibration.
- Place the product at least 30 cm away from the heater, stove and similar sources of heat and at least 5 cm away from electric ovens.
- Do not expose the product to direct sunlight or keep in damp environments.

- The product requires adequate air circulation to function efficiently. If the product will be placed in an alcove, remember to leave at least 5 cm distance between the product and the ceiling and the walls.
- Do not install the product in environments with temperatures below -5°C .

3.2. Attaching the plastic wedges

Use the plastic wedges provided with the product to provide sufficient space for air circulation between the product and the wall.

1. To attach the wedges, remove the screws on the product and use the screws provided with the wedges.

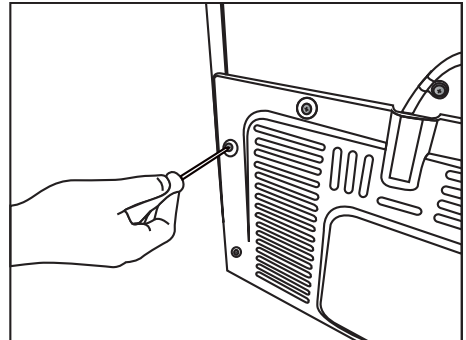

2. Attach 2 plastic wedges on the ventilation cover as shown in the figure.

Installation

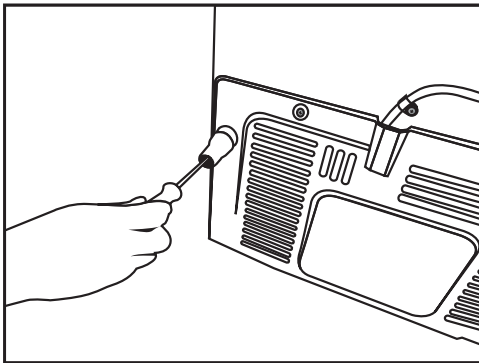

3.3. Adjusting the feet

If the product is not in balanced position, adjust the front adjustable feet by rotating right or left.

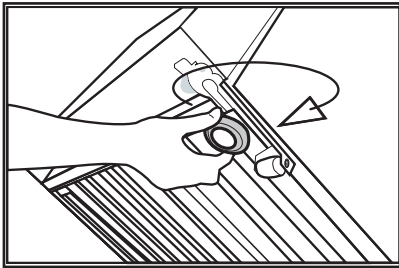

3.4. Power connection



WARNING: Do not use extension or multi sockets in power connection.



WARNING: Damaged power cable must be replaced by authorised Service.



When placing two coolers in adjacent position, leave at least 4 cm distance between the two units.

- Our firm will not assume responsibility for any damages due to usage without earthing and power connection in compliance with national regulations.
- The power cable plug must be easily accessible after installation.
- Connect the refrigerator to an earthed socket with 220-240V/50 Hz voltage. The socket must comprise a 10-16A fuse.
- Do not use multi-group plug with or without extension cable between the wall socket and the refrigerator.

3.5. Water connection

(Optional)



WARNING: Unplug the product and the water pump (if available) during connection.

The product can be connected to a carboy or directly to the water mains, depending on the model. To establish the connection, the water hose must first be connected to the product. Check to see the following parts are supplied with your product's model:

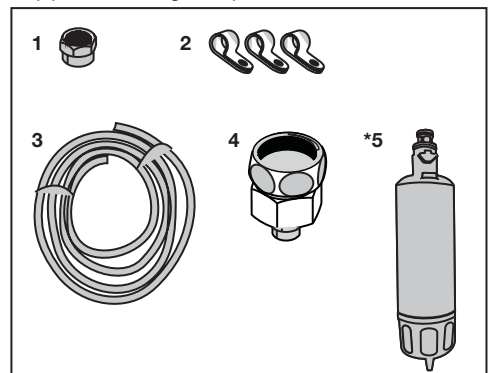

1. Connector (1 piece): Used to attach the water hose to the rear of the product.

Installation

2. Hose clip (3 pieces): Used to fix the water hose on the wall.
3. Water hose (1 piece, 5 meter diameter 1/4 inches): Used for the water connection.
4. Tap adapter (1 piece): Comprises a porous filter, used for connection to the cold water mains.
5. Water filter (1 piece *Optional): Used to connect the mains water to the product. Water filter is not required if carboy connection is available.

3.6. Connecting water hose to the product

To connect the water hose to the product, follow the instructions below.

1. Remove the connector on the hose nozzle adaptor in the back of the product and run the hose through the connector.

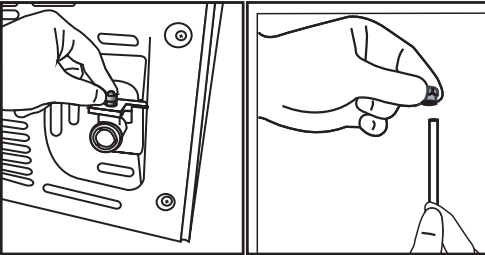

2. Push the water hose down tightly and connect to the hose nozzle adaptor.

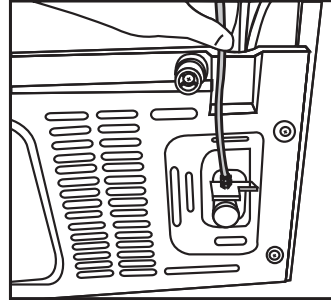

3. Tighten the connector manually to fix on the hose nozzle adaptor. You may also tighten the connector using a pipe wrench or pliers.

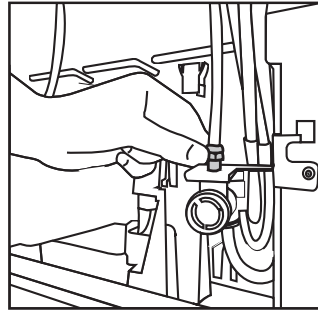

3.7. Connecting to water mains (Optional)

To use the product by connecting to the cold water mains, a standard 1/2" valve connector must be installed to the cold water mains in your home. If the connector is not available or if you are unsure, consult a qualified plumber.

1. Detach the connector (1) from the tap adaptor (2).

Installation

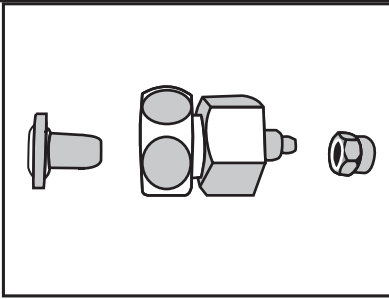

2. Connect the tap adaptor to the water mains valve.

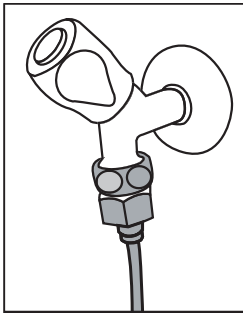

3. Attach the connector around the water hose.

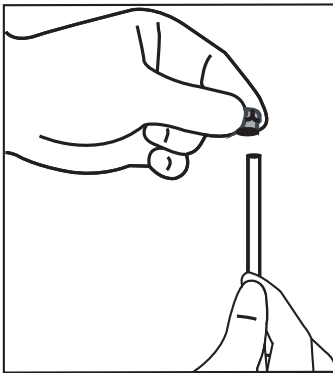

4. Attach the connector into the tap adaptor and tighten by hand / tool.

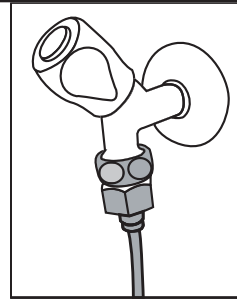

5. To avoid damaging, shifting or accidentally disconnecting the hose, use the clips provided to fix the water hose appropriately.

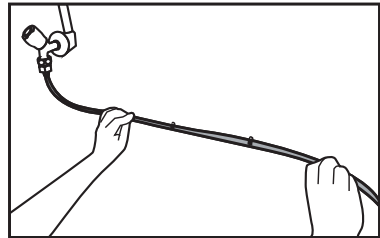

WARNING: After turning the tap on, make sure there is no water leak on either end of the water hose. In case of leakage, turn the valve off and tighten all connections using a pipe wrench or pliers.

3.8. For products using water carboy (Optional)

To use a carboy for the product's water connection, the water pump recommended by the Unauthorised service must be used.

1. Connect one end of the water hose provided with the pump to the product (see 3.6) and follow the instructions below.

Installation

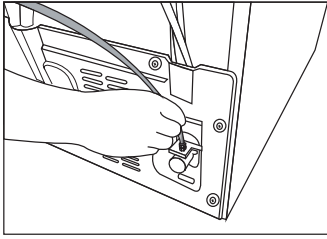

2. Connect the other end of the water hose to the water pump by pushing the hose into the pump's hose inlet.

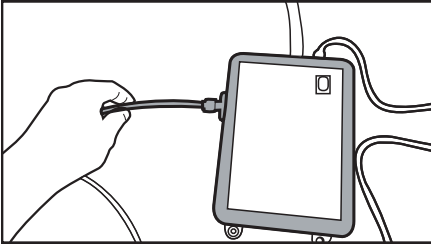

3. Place and fasten the pump hose inside the carboy.

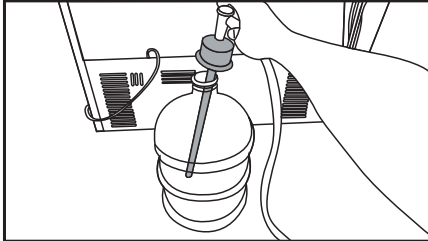

4. Once the connection is established, plug in and start the water pump.



Please wait 2-3 minutes after starting the pump to achieve the desired efficiency.



See also the pump's user guide for water connection.



When using carboy, water filter is not required.

3.9 Water filter

(Optional)

The product may have internal or external filter, depending on the model. To attach the water filter, follow the instructions below.

3.9.1. Fixing external filter on the wall (Optional)



WARNING: Do not fix the filter on the product.

Check to see the following parts are supplied with your product's model:

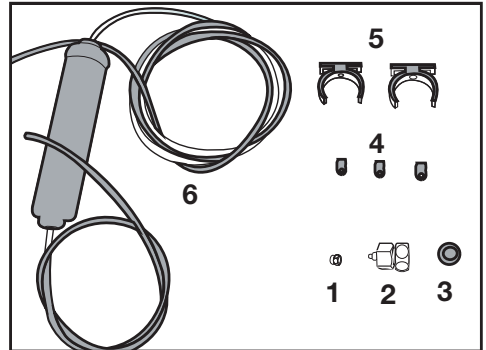

1. Connector (1 piece): Used to attach the water hose to the rear of the product.
2. Tap adapter (1 piece): Used for connection to the cold water mains.
3. Porous filter (1 piece)
4. Hose clip (3 pieces): Used to fix the water hose on the wall.
5. Filter connecting apparatus (2 pieces): Used to fix the filter on the wall.
6. Water filter (1 piece): Used to connect the mains water to the product.

Installation

Water filter is not required if carboy connection is available.

1. Connect the tap adaptor to the water mains valve.

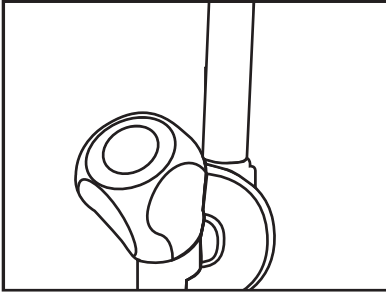

2. Determine the location to fix the external filter. Fix the filter's connecting apparatus (5) on the wall.

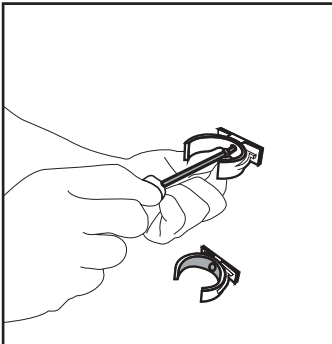

3. Attach the filter in upright position on the filter connecting apparatus, as indicated on the label. (6).

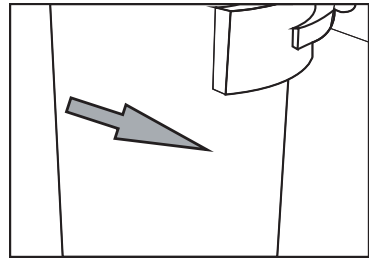
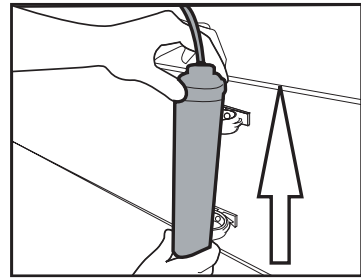

4. Attach the water hose extending from the top of the filter to the product's water connection adaptor (see. 3 6).

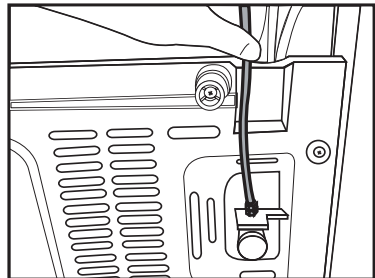

After the connection is established, it should look like the figure below.

Installation

Water line:

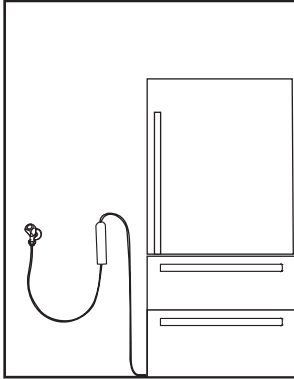

Carboy line:

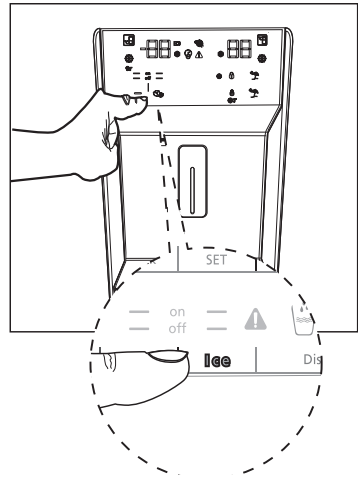
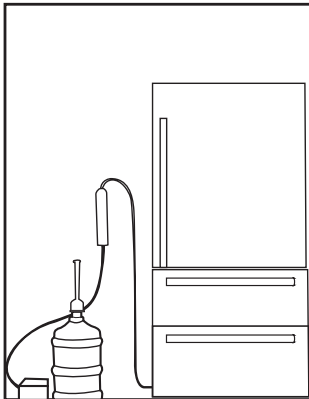

2. Remove the water filter by-pass cover by pulling.



A few drops of water may flow out after removing the cover; this is normal.

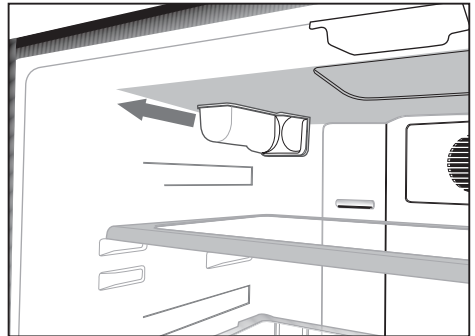

3. Place the water filter cover into the mechanism and push to lock in place.

3.9.2. Internal filter

The internal filter provided with the product is not installed upon delivery; please follow the instructions below to install the filter.

1. "Ice Off" indicator must be active while installing the filter. Switch the ON-OFF indicator using the "Ice" button on the screen.

Installation

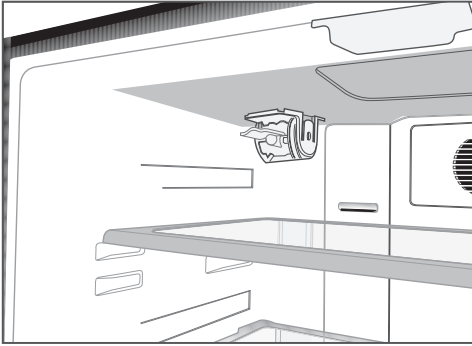

4. Push the **“Ice”** button on the screen again to cancel the **“Ice Off ”** mode.



The water filter will clear certain foreign particles in the water. It will not clear the microorganisms in the water.



The filter replacement period of your product is 6 months.

4 Preparation

4.1. What to do for energy saving



Connecting the product to electronic energy-saving systems is harmful, as it may damage the product.

- Do not keep the refrigerator doors open for long periods.
- Do not place hot food or beverages into the refrigerator.
- Do not overfill the refrigerator; blocking the internal air flow will reduce cooling capacity.
- To be able to store maximum food in the freezer compartment of your refrigerator, the upper drawers have to be removed and placed on top of wire rack. The net volume and energy consumption values specified in the energy label of the refrigerator was tested after removing the freezer compartment's upper shelf and the ice container which can easily be removed manually. Using the lower drawer while loading is highly recommended.
- Depending on the product's features; defrosting frozen foods in the cooler compartment will ensure energy saving and preserve food quality.
- Make sure the foods are not in contact with the cooler compartment temperature sensor described below.
- Food must be stored in drawers inside the cooler compartment in order to provide energy saving and preserve the food in a better ambient.
- Prevent direct contact between the temperature sensor in the freezer compartment and the food packages. Energy consumption may increase in case of a contact with the sensor.

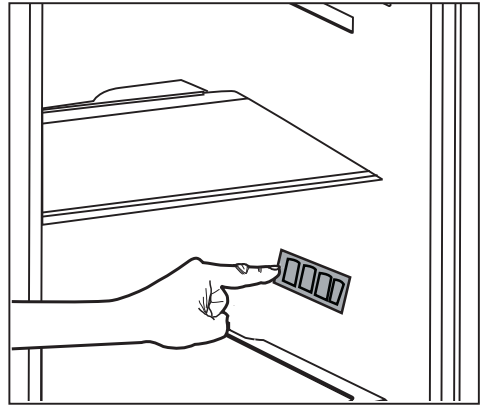

4.2. First use

Before using your refrigerator, make sure the necessary preparations are made in line with the instructions in "Safety and environment instructions" and "Installation" sections.

- Keep the product running with no food inside for 6 hours and do not open the door, unless absolutely necessary.



A sound will be heard when the compressor is engaged. It is normal to hear sound even when the compressor is inactive, due to the compressed liquids and gasses in the cooling system.



It is normal for the front edges of the refrigerator to be warm. These areas are designed to warm up in order to prevent condensation.



In some models, indicator panel is dimmed automatically 5 minutes after the door is closed. It will be activated again when the door is opened or any key is pressed.

5 Using the product

5.1. Indicator panel

Indicator panels may vary depending on the model of your product.

Audio and visual functions of the indicator panel will assist in using the refrigerator.

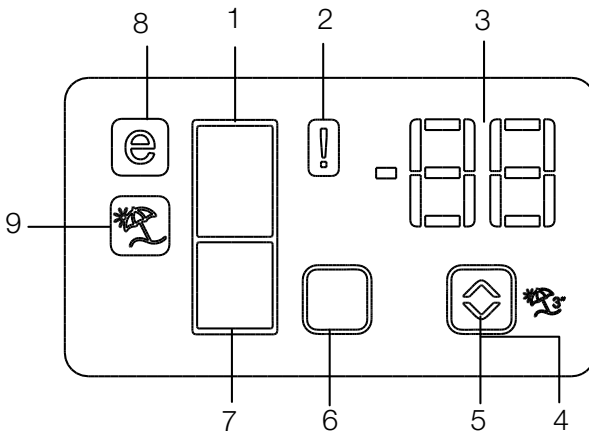

1. Cooler compartment indicator
2. Error status indicator
3. Temperature indicator
4. Vacation function button
5. Temperature adjustment button
6. Compartment selection button
7. Freezer compartment indicator
8. Economy mode indicator
9. Vacation function indicator

***optional**



*Optional: Figures in this user guide are schematic and may not exactly match your product. If your product does not comprise the relevant parts, the information pertains to other models.

Using the product

1. Cooler compartment indicator

The cooler compartment light will turn on when adjusting the cooler compartment temperature.

2. Error status indicator

This sensor will activate if the refrigerator is not cooling adequately or in case of sensor fault. When this indicator is active, the freezer compartment temperature indicator will display "E" and the cooler compartment temperature indicator will display "1, 2, 3..." etc. numbers. The numbers on the indicator serve to inform the service personnel about the fault. (❗)

3. Temperature indicator

Indicates the temperature of the freezer and cooler compartments.

4. Vacation function button

To activate this function, press and hold the Vacation button for 3 seconds. When the Vacation function is active, the cooler compartment temperature indicator displays the inscription "- -" and no cooling process will be active in the cooling compartment. This function is not suitable to keep food in the cooler compartment. Other compartments will remain cooled with the respective temperature set for each compartment. Push the **Vacation** button (🏖️) again to cancel this function.

5. Temperature adjustment button

Respective compartment's temperature varies in -24°C... -18°C and 8°C...1°C ranges. (🌡️)

6. Compartment selection button

Use the refrigerator compartment selection button to toggle between the cooler and freezer compartments. (🗄️)

7. Freezer compartment indicator

The freezer compartment light will turn on when adjusting the freezer compartment temperature.

8. Economy mode indicator

Indicates the refrigerator is running on energy-saving mode. This indicator will be active when the temperature in the freezer compartment is set to -18°C. (🌡️)

9. Vacation function indicator

Indicates the vacation function is active. (🏖️)

Using the product

Indicator panel

This touch-control indicator panel allows you to set the temperature without opening the door of your refrigerator. Just touch the relevant button with your finger to set the temperature.

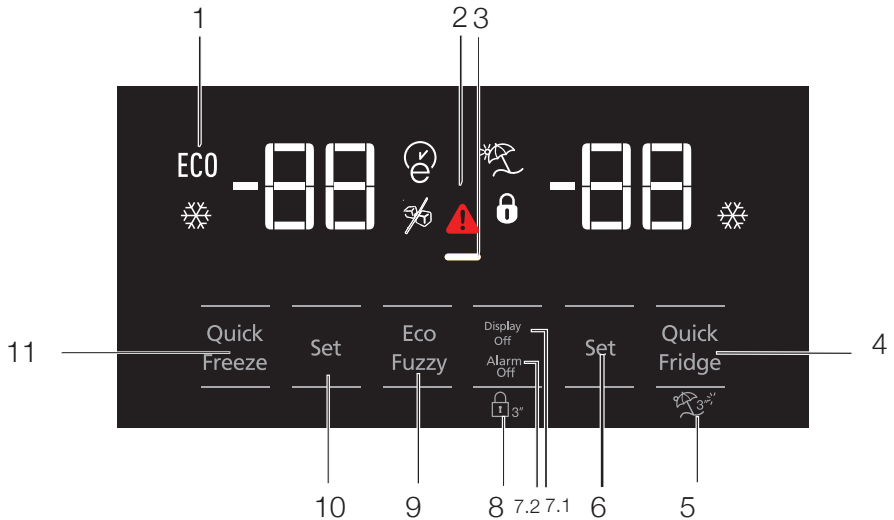

- 1- Economic use
- 2- High temperature / fault alert
- 3- Energy saving function (display off)
- 4- Rapid cooling
- 5- Vacation function
- 6- Cooler compartment temperature setting
- 7- Energy saving (display off) / Alarm off warning
- 8- Keypad lock
- 9- Eco-fuzzy
- 10- Freezer compartment temperature setting
- 11- Rapid freezing



*Optional: Figures in this user guide are schematic and may not exactly match your product. If your product does not comprise the relevant parts, the information pertains to other models.

Using the product

1. Economic use

This sign will light up when the freezer compartment is set to -18°C , the most economical setting. (ECO) Economic use indicator will turn off when rapid cooling or rapid freezing function is selected.

2. High temperature / fault alert

This indicator () will light up in case of temperature faults or fault alerts. If you see this indicator is lit up, please see the "recommended solutions for problems" section in this guide.

This indicator illuminates during power failure, high temperature failures and error warnings. During sustained power failures, the highest temperature that the freezer compartment reaches will flash on the digital display. After checking the food located in the freezer compartment press the alarm off button to clear the warning.

Please refer to "remedies advised for troubleshooting" section on your manual if you observe that this indicator is illuminated.



3. Energy saving function (display off)

If the product doors are kept closed for a long time energy saving function is automatically activated and energy saving symbol is illuminated. When energy saving function is activated, all symbols on the display other than energy saving symbol will turn off. When the Energy Saving function is activated, if any button is pressed or the door is opened, energy saving function will be cancelled and the symbols on display will return to normal. Energy saving function is activated during delivery from factory and cannot be cancelled.

4. Rapid cooling

When the rapid cooling function is turned on, the rapid cool indicator will light up () and the cooler compartment temperature indicator will display the value 1. Push the Rapid cool button again to cancel this function. The Rapid cool indicator will turn off and return to normal setting. The rapid cooling function will be automatically cancelled after 1 hour, unless cancelled by the user. Too cool a large amount of fresh food, press the rapid cool button before placing the food in the cooler compartment.



5. Vacation function

To activate the Vacation function, press the button for () 3 seconds; this will activate the vacation mode indicator (). When the Vacation function is active, the cooler compartment temperature indicator displays the inscription "- -" and no cooling process will be active in the cooling compartment. This function is not suitable to keep food in the cooler compartment. Other compartments will remain cooled with the respective temperature set for each compartment. Push the **vacation** function button again to cancel this function

6. Cooler compartment temperature setting

After pressing the button, the cooler compartment temperature can be set to 8,7,6,5,4,3,2 and 1 respectively. ()

7.1. Energy saving (display off)

Pressing this button () will light up the energy saving sign () and the Energy-saving function will activate. Activating the energy-saving function will turn off all other signs on the display. When the energy-saving function is active, pressing any button or opening the door will deactivate the energy-saving function and the display signals will



Using the product

return to normal. Pressing this button () again will turn off the energy-saving sign and deactivate the energy-saving function.

7.2. Alarm off warning:

In case of power failure/high temperature alarm, after checking the food located in the freezer compartment press the alarm off button to clear the warning.

8. Keypad lock

Press the keypad lock button () simultaneously for 3 seconds. The keypad lock sign () will light up and the keypad lock will be activated. The buttons will be inactive when the Keypad lock is activated. Press the Keypad lock button again simultaneously for 3 seconds. The keypad lock sign will turn off and the keypad lock mode will be disengaged. Press the **keypad lock** button () to prevent changing the refrigerator's temperature settings.

9. Eco-fuzzy

To activate the eco-fuzzy function, press and hold the eco-fuzzy button for 1 second. When this function is active, the freezer will switch to the economic mode after at least 6 hours and the economic use indicator will light up. To deactivate the () eco-fuzzy function, press and hold the eco-fuzzy function button for 3 seconds.

The indicator will light up after 6 hours when the eco-fuzzy function is active.

10. Freezer compartment temperature setting

The temperature in the freezer compartment is adjustable. Pressing the button will enable the freezer compartment temperature to be set at -18, -19, -20, -21, -22, -23 and -24. ()

11. Rapid freezing

For rapid freezing, press the button; this will activate the rapid freezing indicator ().

When the rapid freezing function is turned on, the rapid freeze indicator will light up and the freezer compartment temperature indicator will display the value -27. Press the Rapid freeze button () again to cancel this function. The Rapid freeze indicator will turn off and return to normal setting. The rapid freezing function will be automatically cancelled after 24 hours, unless cancelled by the user. To freeze a large amount of fresh food, press the rapid freeze button before placing the food in the freezer compartment.

Using the product

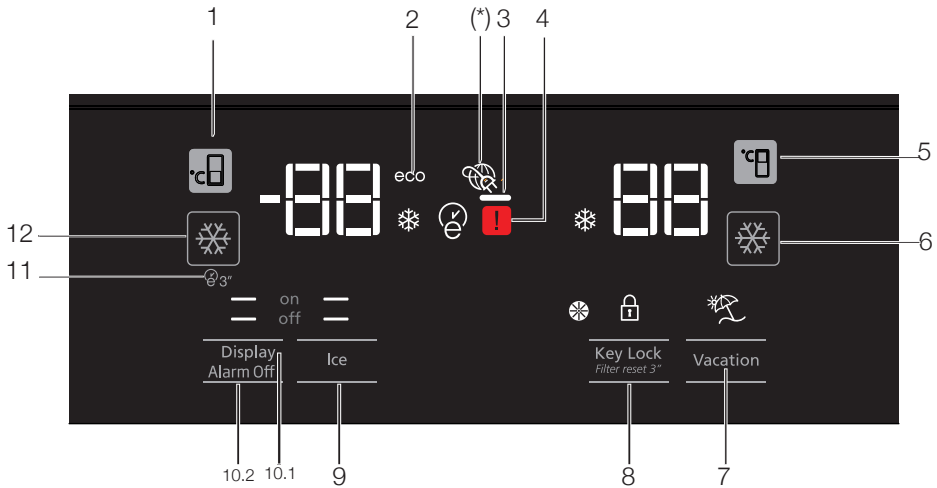

1. Freezer compartment temperature setting
2. Economy mode
- 3- Energy saving function (display off)
4. Error status
5. Cooler compartment temperature setting
6. Rapid cooling
7. Vacation function
8. Keypad lock / filter replacing alert cancellation
9. Ice making on/off
10. Display on/off /Alarm off
11. Autoeco
12. Rapid freezing



*Optional: Figures in this user guide are schematic and may not exactly match your product. If your product does not comprise the relevant parts, the information pertains to other models.

Using the product

1. Freezer compartment temperature setting

Pressing the button  will enable the freezer compartment temperature to be set at -18,-19,-20,-21,-22,-23,-24,-18...

2. Economy mode

Indicates the refrigerator is running on energy-saving mode. This indicator will be active when the freezer compartment temperature is set at -18 or the energy-saving cooling is engaged by **eco-extra** function. (ECO)

3. Energy saving function (display off)

If the product doors are kept closed for a long time energy saving function is automatically activated and energy saving symbol is illuminated. When energy saving function is activated, all symbols on the display other than energy saving symbol will turn off. When the Energy Saving function is activated, if any button is pressed or the door is opened, energy saving function will be cancelled and the symbols on display will return to normal. Energy saving function is activated during delivery from factory and cannot be cancelled.

4. Error status

This sign will activate if the refrigerator is not cooling adequately or in case of sensor fault. 

When this indicator is activated, the freezer compartment temperature indicator will display "E" and the cooler compartment temperature indicator will display "1, 2, 3..." etc. numbers. The numbers on the indicator serve to inform the service personnel about the fault.

5. Cooler compartment temperature setting

After pressing the button , the cooler compartment temperature can be set to 8,7,6,5,4,3,2... respectively.



6. Rapid cooling

For rapid cooling, press the button; this will activate the rapid cooling indicator ().



Press this button again to deactivate this function.

Use this function when placing fresh foods into the cooler compartment or to rapidly cool the food items. When this function is activated, the refrigerator will be engaged for 1 hour.

7. Vacation function

When the Vacation function () is active, the cooler compartment temperature indicator displays the inscription "- -" and no cooling process will be active in the cooling compartment. This function is not suitable to keep food in the cooler compartment. Other compartments will remain cooled with the respective temperature set for each compartment. Press the **vacation** function button again to cancel this function. ()

8. Keypad lock / Keypad lock / filter replacing alert cancellation

Press keypad lock button () to activate the keypad lock. You may also use this function to prevent changing the refrigerator's temperature settings. The refrigerator's filter must be replaced every 6 months. If you follow the instructions in the section 5.2, the refrigerator will automatically calculate the remaining period and the filter replacing alert indicator () will light up when filter expires.

Using the product

Press and hold the button (❄️) for 3 seconds to turn off the filter alert light.

9. Ice making on/off

Press the button (❄️) to cancel (off —) or activate (on —) ice-making.

10.1 Display on/off

Press the button to cancel (— off) or activate (— on) display on/off.

10.2 Alarm off warning

In case of power failure/high temperature alarm, after checking the food located in the freezer compartment press the alarm off button to clear the warning.

11. Autoeco

Press the auto eco button (🌿), for 3 seconds to activate this function. If the door remains closed for a long time when this function is activated, the cooler section will switch to economic mode. Press the button again to deactivate this function. The indicator will light up after 6 hours when the auto eco function is active. (🌿)

12. Rapid freezing

Press the button (❄️) for rapid freezing. Press the button again to deactivate the function.

Using the product

5.2. Zero degree compartment

(Optional)

Use this compartment to keep delicatessen at lower temperatures or meat products for immediate consumption. Do not place fruits and vegetables in this compartment. You can expand the product's internal volume by removing any of the zero degree compartments. To remove the compartment, simply pull forth, lift up and pull out.

5.3. Vegetable bin

The refrigerator's vegetable bin is designed to keep vegetables fresh by preserving humidity. For this purpose, the overall cold air circulation is intensified in the vegetable bin. Keep fruits and vegetables in this compartment. Keep the greenleaved vegetables and fruits separately to prolong their life.

5.4. Blue light

(Optional)

The product's vegetable bins comprise blue light. The vegetables in the bin will continue photosynthesize under the blue light's wavelength effect and remain fresh longer.

5.5. Description and cleaning of odour filter

(Optional)

Odour filter prevents unpleasant odour build-up in your product.

1. Pull the cover into which the odour filter is installed downwards from the front section and remove as illustrated.
2. Leave the filter under sunlight for one day. Filter will be cleaned during this time.
3. Install the filter back to its place.



Odour filter must be cleaned once in a year.

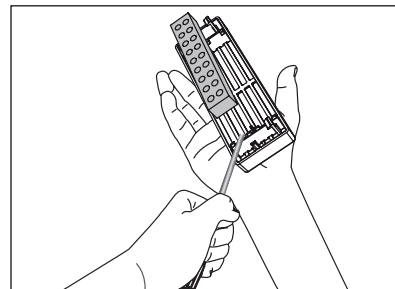
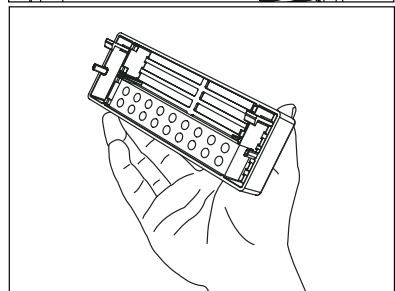
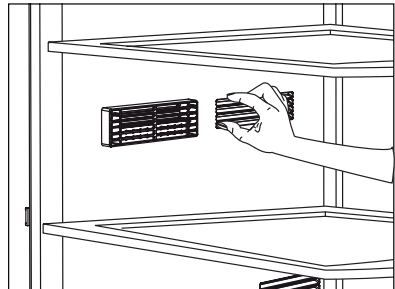

Using the product

5.6. Telescopic drawer

Pay attention not to squeeze any parts of your body such as hands, feet and etc. between the movable parts while the drawer is in use in order to avoid any injury.

You can remove the partition in the drawer as illustrated when you want to clean it.

You can remove the drawers only for cleaning. It is not possible to group the drawers in their places after loading them with food when they are removed.

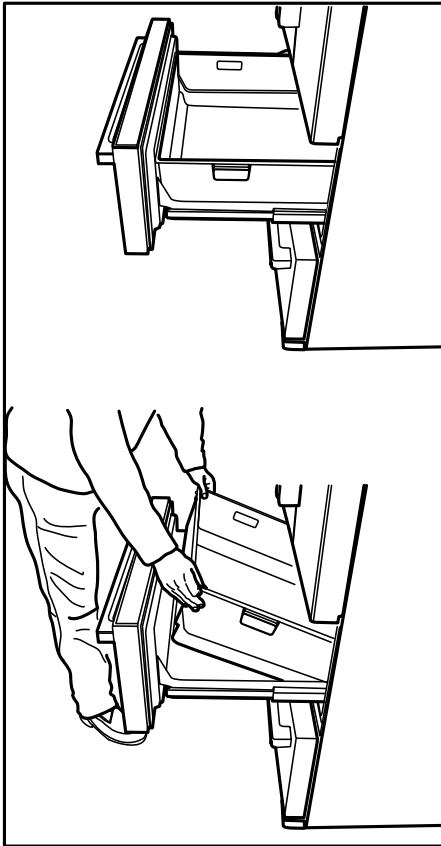

5.7. Ionizer

(Optional)

The ionizer system in the cooler compartment's air duct serves to ionize the air. The negative ion emissions will eliminate bacteria and other molecules causing odour in the air.

5.8. Ice box

(Optional)

Please read the warnings carefully on the ice container. The ice container is used for ice collection poured ice machine. Do not put water in it to make ice as it may break. The ice container is not used for storing foods.

Warning: Do not change the location of the ice container.

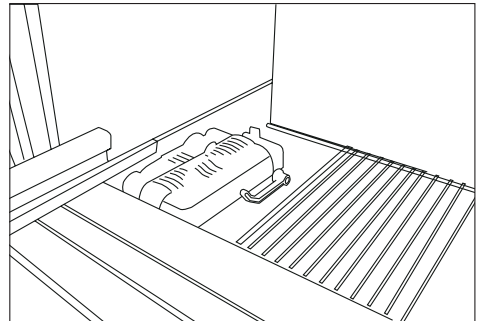

5.9. Ice maker

(Optional)

The ice machine is nonremovable. There must be ice container at the bottom of the ice machine.

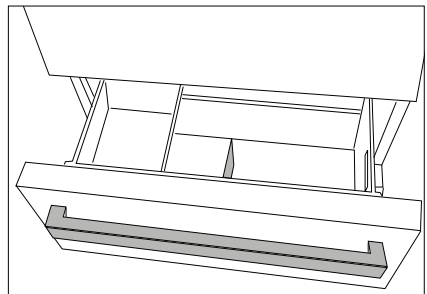

Using the product

5.10. Movable middle section

Movable middle section is intended to prevent the cold air inside your refrigerator from escaping outside. Sealing is provided when the gaskets on the door presses on the surface of the movable middle section while the cooler compartment doors are closed.

Another reason that your refrigerator is equipped with a movable middle section is that it increases the net volume of the cooler compartment. Standard middle sections occupy some non-usable volume in the refrigerator.

Movable middle section is closed when the left door of the cooler compartment is closed.

It must not be opened manually. It moves under the guidance of the plastic part on the body while the door is closed.

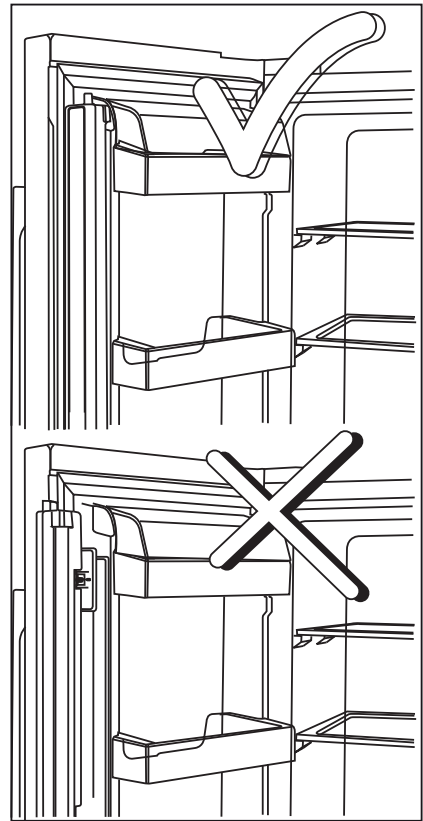

5.11. Ice container (Optional)

Ice container allows you to obtain ice from the product easily.

Using the ice container

1. Remove the ice container from the freezer compartment.
2. Fill the ice container with water.
3. Place the ice container in the freezer compartment. About two hours later, the ice is ready.
4. Remove the ice container from the freezer compartment and bend it over the service plate. Ice cubes will easily fall down to the service plate.

Using the product

5.12. Freezing fresh food

- To preserve food quality, the food items placed in the freezer compartment must be frozen as quickly as possible, use the rapid freezing for this.
- Freezing the food items when fresh will extend the storage time in the freezer compartment.
- Pack the food items in air-tight packs and seal tightly.
- Make sure the food items are packed before putting in the freezer. Use freezer holders, tinfoil and damp-proof paper, plastic bag or similar packaging materials instead of traditional packaging paper.
- Mark each food pack by writing the date on the package before freezing. This will allow you to determine the freshness of each pack every time the freezer is opened. Keep the earlier food items in the front to ensure they are used first.
- Frozen food items must be used immediately after defrosting and should not be frozen again.
- Do not freeze large quantities of food at once.

Freezer Compartment Setting	Cooler compartment Setting	Descriptions
-18°C	4°C	This is the default, recommended setting.
-20, -22 or -24°C	4°C	These settings are recommended for ambient temperatures exceeding 30°C.
Rapid Freeze	4°C	Use this to freeze food items in a short time. The product will reset to previous settings when the process is completed.
-18°C or colder	2°C	Use these settings if you believe the cooler compartment is not cold enough due to ambient temperature or frequently opening the door.

5.13. Recommendations for storing frozen foods

The compartment must be set to at least -18°C.

1. Place the food items in the freezer as quickly as possible to avoid defrosting.
2. Before freezing, check the "Expiry Date" on the package to make sure it is not expired.
3. Make sure the food's packaging is not damaged.

5.14. Deep freezer details

As per the IEC 62552 standards, the freezer must have the capacity to freeze 4.5 kg of food items at -18°C or lower temperatures in 24 hours for each 100 litres of freezer compartment volume. Food items can only be preserved for extended periods at or below temperature of -18°C. You can keep the foods fresh for months (in deep freezer at or below temperatures of 18°C). The food items to be frozen must not contact the already-frozen food inside to avoid partial defrosting.

Using the product

Boil the vegetables and filter the water to extend the frozen storage time. Place the food in air-tight packages after filtering and place in the freezer. Bananas, tomatoes, lettuce, celery, boiled eggs, potatoes and similar food items should not be frozen. When these foods are frozen, only their nutritional value and taste shall be affected negatively. They shall not be spoiled so that they would create a risk for human health.

5.15. Placing the food

Freezer compartment shelves	Various frozen foods including meat, fish, ice cream, vegetables etc.
Cooler compartment shelves	Food items inside pots, capped plate and capped cases, eggs (in capped case)
Cooler compartment door shelves	Small and packed food or beverages
Vegetable bin	Fruits and vegetables
Fresh food compartment	Delicatessen (breakfast food, meat products to be consumed in short notice)

5.16. Door open alert (Optional)

An audible alert will be heard if the product's door remains open for 1 minute. The audible alert will stop when the door is closed or any button on the display (if available) is pressed.

5.17. Interior light

Interior light uses a LED type lamp. Contact the authorised service for any problems with this lamp. Interior light used in this product is not intended for home lighting and not suitable for such purposes. Interior lights in cooler or freezer compartments are intended to help safe and convenient food placement into the refrigerator. The lamp(s) used in this appliance is not suitable for household room illumination. The intended purpose of this lamp is to assist the user to place foodstuffs in the refrigerator/freezer in a safe and comfortable way.

6 Maintenance and Cleaning

Cleaning the product regularly will prolong its service life.



WARNING: Disconnect the power before cleaning the refrigerator.

- Do not use sharp and abrasive tools, soap, house cleaning materials, detergents, gas, gasoline, varnish and similar substances for cleaning.
- Melt a teaspoonful of carbonate in the water. Moisten a piece of cloth in the water and wring out. Wipe the device with this cloth and dry off thoroughly.
- Take care to keep water away from the lamp's cover and other electrical parts.
- Clean the door using a wet cloth. Remove all items inside to detach the door and chassis shelves. Lift the door shelves up to detach. Clean and dry the shelves, then attach back in place by sliding from above.
- Do not use chloric water or cleaning products on the exterior surface and chrome-coated parts of the product. Chlorine will cause rust on such metallic surfaces.
- Do not use sharp, abrasive tools, soap, household cleaning agents, detergents, kerosene, fuel oil, varnish etc. to prevent removal and deformation of the prints on the plastic part. Use lukewarm water and a soft cloth for cleaning and then wipe it dry.

6.1. Preventing Bad Odour

The product is manufactured free of any odorous materials. However, keeping the food in inappropriate sections and improper cleaning of internal surfaces may lead to malodour.

To avoid this, clean the inside with carbonated water every 15 days.

- Keep the foods in sealed holders. Microorganisms may spread out of unsealed food items and cause malodour.
- Do not keep expired and spoilt foods in the refrigerator.

6.2. Protecting Plastic Surfaces

Oil spilled on plastic surfaces may damage the surface and must be cleaned immediately with warm water.

7 Troubleshooting

Check this list before contacting the service. Doing so will save you time and money. This list includes frequent complaints that are not related to faulty workmanship or materials. Certain features mentioned herein may not apply to your product.

The refrigerator is not working.

- The power plug is not fully engaged. >>> Push the plug completely into the socket.
- The fuse connected to the socket powering the product or the main fuse is blown. >>> Check the fuses.

Condensation on the side wall of the cooler compartment (MULTI ZONE, COOL, CONTROL and FLEXI ZONE).

- The environment is too cold. >>> Do not install the product in environments with temperatures below -5°C.
- The door is opened too frequently >>> Take care not to open the product's door too frequently.
- The environment is too humid. >>> Do not install the product in humid environments.
- Foods containing liquids are kept in unsealed holders. >>> Keep the foods containing liquids in sealed holders.
- The product's door is left open. >>> Do not keep the product's door open for long periods.
- The thermostat is set to too low temperature. >>> Set the thermostat to appropriate temperature.

Compressor is not working.

- In case of sudden power failure or pulling the power plug off and putting back on, the gas pressure in the product's cooling system is not balanced, which triggers the compressor thermic safeguard. The product will restart after approximately 6 minutes. If the product does not restart after this period, contact the Authorised Service Agent.
- Defrosting is active. >>> This is normal for a fully-automatic defrosting product. The defrosting is carried out periodically.
- The product is not plugged in. >>> Make sure the power cord is plugged in.
- The temperature setting is incorrect. >>> Select the appropriate temperature setting.
- The power is out. >>> The product will continue to operate normally once the power is restored.

The refrigerator's operating noise is increasing while in use.

- The product's operating performance may vary depending on the ambient temperature variations. This is normal and not a malfunction.

The refrigerator runs too often or for too long.

Troubleshooting

- The new product may be larger than your previous one. Larger products will run for longer periods.
- The room temperature may be high. >>> The product will normally run for long periods in higher room temperature.
- The product may have been recently plugged in or a new food item is placed inside. >>> The product will take longer to reach the set temperature when recently plugged in or a new food item is placed inside. This is normal
- Large quantities of hot food may have been recently placed into the product. >>> Do not place hot food into the product.
- The doors were opened frequently or kept open for long periods. >>> The warm air moving inside will cause the product to run longer. Do not open the doors too frequently.
- The freezer or cooler door may be ajar. >>> Check that the doors are fully closed.
- The product may be set to temperature too low. >>> Set the temperature to a higher degree and wait for the product to reach the adjusted temperature.
- The cooler or freezer door washer may be dirty, worn out, broken or not properly settled. >>> Clean or replace the washer. Damaged / torn door washer will cause the product to run for longer periods to preserve the current temperature.

The freezer temperature is very low, but the cooler temperature is adequate.

- The freezer compartment temperature is set to a very low degree. >>> Set the freezer compartment temperature to a higher degree and check again.

The cooler temperature is very low, but the freezer temperature is adequate.

- The cooler compartment temperature is set to a very low degree. >>> Set the freezer compartment temperature to a higher degree and check again.

The food items kept in cooler compartment drawers are frozen.

- The cooler compartment temperature is set to a very low degree. >>> Set the freezer compartment temperature to a higher degree and check again.

The temperature in the cooler or the freezer is too high.

- The cooler compartment temperature is set to a very high degree. >>> Cooler compartment temperature setting has an effect on the freezer compartment temperature. Change the temperature of the cooler or freezer compartment and wait until the temperature of the related compartments come to the adequate level.
- The doors were opened frequently or kept open for long periods. >>> Do not open the doors too frequently.
- The door may be ajar. >>> Fully close the door.
- The product may have been recently plugged in or a new food item is placed inside. >>> This is normal. The product will take longer to reach the set temperature when recently plugged in or a new food item is placed inside.
- Large quantities of hot food may have been recently placed into the product. >>> Do not place hot food into the product.

Shaking or noise.

Troubleshooting

- The ground is not level or durable. >>> If the product is shaking when moved slowly, adjust the stands to balance the product. Also make sure the ground is sufficiently durable to bear the product.
- Any items placed on the product may cause noise. >>> Remove any items placed on the product.

The product is making noise of liquid flowing, spraying etc.

- The product's operating principles involve liquid and gas flows. >>> This is normal and not a malfunction.

There is sound of wind blowing coming from the product.

- The product uses a fan for the cooling process. This is normal and not a malfunction.

There is condensation on the product's internal walls.

- Hot or humid weather will increase icing and condensation. This is normal and not a malfunction.
- The doors were opened frequently or kept open for long periods. >>> Do not open the doors too frequently; if open, close the door.
- The door may be ajar. >>> Fully close the door.

There is condensation on the product's exterior or between the doors.

- The ambient weather may be humid, this is quite normal in humid weather. >>> The condensation will dissipate when the humidity is reduced.

The interior smells bad.

- The product is not cleaned regularly. >>> Clean the interior regularly using sponge, warm water and carbonated water.
- Certain holders and packaging materials may cause odour. >>> Use holders and packaging materials without free of odour.
- The foods were placed in unsealed holders. >>> Keep the foods in sealed holders. Microorganisms may spread out of unsealed food items and cause malodour.
- Remove any expired or spoilt foods from the product.

The door is not closing.

- Food packages may be blocking the door. >>> Relocate any items blocking the doors.
- The product is not standing in full upright position on the ground. >>> Adjust the stands to balance the product.
- The ground is not level or durable. >>> Make sure the ground is level and sufficiently durable to bear the product.

The vegetable bin is jammed.

- The food items may be in contact with the upper section of the drawer. >>> Reorganize the food items in the drawer.



WARNING: If the problem persists after following the instructions in this section, contact your vendor or an Authorised Service Agent. Do not try to repair the product.

GUARANTEE DETAILS

Your new Beko product is guaranteed against the cost of breakdown repair for two year from the date of the original purchase.

What is covered?

- Repairs necessary as a result of faulty materials, defective components or manufacturing defect
- The cost of functional replacement parts, but excluding consumable items.
- The labour costs of a Beko approved repairer to carry out the repair.

What is not covered?

- Transit, delivery or accidental damage or misuse and abuse.
- Cabinet or appearance parts, including control knobs, flaps, handles or container lids.
- Accessories or consumable items including but not limited to, ice trays, scrapers, cutlery baskets, filters and light bulbs.
- Repairs required as a result of unauthorised repair or inexperienced installation that fails to meet the requirements contained in the user instruction book.
- Repairs to products used on commercial or non-residential household premises.
- Loss of frozen food in freezers or fridge/freezers. (Food loss insurance is often included within your household contents insurance policy, or may be available separately from your retailer).

Important notes.

- Your Beko product is designed and built for domestic household use only.
- The guarantee will be void if the product is installed or used in commercial or non-residential domestic household premises.
- The product must be correctly installed, located and operated in accordance with the instructions contained in the User Instructions Booklet provided.
- Professional installation by a qualified Electrical Domestic Appliance Installer is recommended for all Washing Machines, Dishwashers and Electric Cookers
- Gas Cookers must only be installed by a Gas Safe (or BORD GAIS) registered Gas Installer.
- The guarantee is given only within the boundaries of the United Kingdom and the Republic of Ireland.
- The guarantee is applicable only to new products and is not transferable if the product is resold.
- Beko disclaims any liability for incidental or consequential damages.
The guarantee does not in anyway diminish your statutory or legal rights.

HOW TO OBTAIN SERVICE

Please keep your purchase receipt or other proof of purchase in a safe place; you will need to have it should the product require attention under guarantee.

You should also complete the details below; it will help us assist you when requesting service. (The model number is printed on the Instruction Booklet and the serial number is printed on the Rating Label affixed to the appliance)

Model No: Obtaining service please contact Beko Customer Help-Line.

Serial No:

Retailer:

Date of purchase: Tel: 0845 6004911 or 0345 6004911

For service under guarantee simply telephone the appropriate number below

UK Mainland & Northern Ireland

Fridges & Freezers	0845 6004903	or	0345 6004903
Electric Cookers	0845 6004902	or	0345 6004902
Gas & Dual Fuel Cookers	0845 6004905	or	0345 6004905
Washing Machines & Dishwashers	0845 6004906	or	0345 6004906

Republic of Ireland

All Refrigeration 01 862 3411
All Cookers
Washing Machines & Dishwashers

Before requesting service please check the trouble-shooting guide in the Operating Instructions as a charge may be levied where no fault is found even though your product may still be under guarantee.

Service once the manufacturer's guarantee has expired.

If you have purchased an extended guarantee please refer to the instructions contained within the extended guarantee agreement document. Otherwise please call the appropriate number above where service can be obtained at a charge.

Should you experience any difficulty in obtaining service please contact the Beko Customer Help-Line. Tel: 0845 6004911 e-mail: service@beko.co.uk



BEKO plc
Beko House
1 Greenhill Crescent
Watford
Hertfordshire
WD18 8QU
Tel: 0845 6004911
Fax: 0 845 6004922
e-mail: service@beko.co.uk
website: www.beko.co.uk

57 5233 0000/AI

Free Manuals Download Website

<http://myh66.com>

<http://usermanuals.us>

<http://www.somanuals.com>

<http://www.4manuals.cc>

<http://www.manual-lib.com>

<http://www.404manual.com>

<http://www.luxmanual.com>

<http://aubethermostatmanual.com>

Golf course search by state

<http://golfingnear.com>

Email search by domain

<http://emailbydomain.com>

Auto manuals search

<http://auto.somanuals.com>

TV manuals search

<http://tv.somanuals.com>