

# Double Oven

User manual

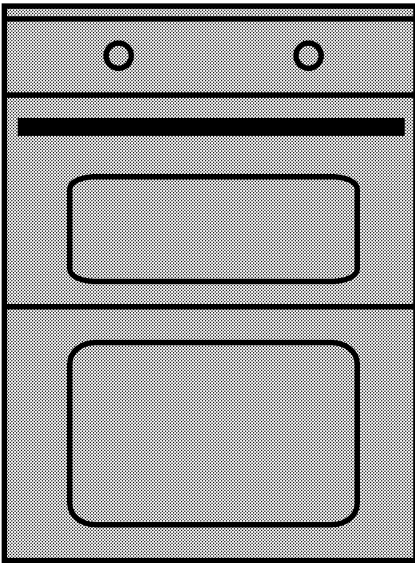

KDVC563AK  
KDVC563AW

**EN**

485.3015.96/R.AA/28.04.2017

## Please read this user manual first!

Dear Customer,

Thank you for purchasing this Beko product. We hope that you get the best results from your product which has been manufactured with high quality and state-of-the-art technology. Therefore, please read this entire user manual and all other accompanying documents carefully before using the product and keep it as a reference for future use. If you handover the product to someone else, give the user manual as well. Follow all warnings and information in the user manual.

Remember that this user manual is also applicable for several other models. Differences between models will be identified in the manual.

### Explanation of symbols

Throughout this user manual the following symbols are used:

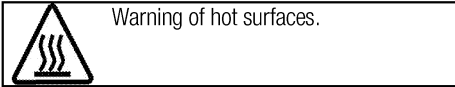
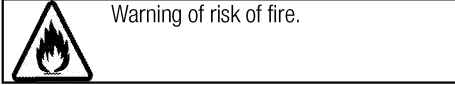
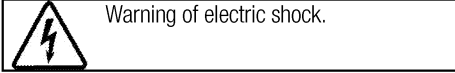
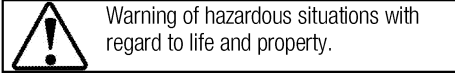
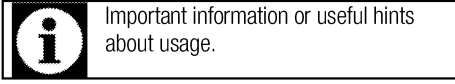

**Arçelik A.Ş.**  
Karaağaç caddesi No:2-6  
34445 Söğütözü/İstanbul/TURKEY  
Made in TURKEY



This product was manufactured using the latest technology in environmentally friendly conditions.

## TABLE OF CONTENTS

### **1 Important instructions and warnings for safety and environment 4**

General safety .....	4
Electrical safety .....	4
Product safety .....	5
Intended use .....	8
Safety for children.....	8
Disposing of the old product .....	9
Package information .....	9
Future Transportation.....	9

### **2 General information 10**

Overview .....	10
Package contents .....	11
Technical specifications .....	12

### **3 Installation 13**

Before installation .....	13
Installation and connection .....	14

### **4 Preparation 16**

Tips for saving energy .....	16
Initial use.....	16
First cleaning of the appliance .....	16
Initial heating.....	16

### **5 How to use the hob 17**

General information about cooking.....	17
Using the hobs.....	17

### **6 How to operate the oven 19**

General information on baking, roasting and grilling	19
How to operate the electric oven .....	19
Operating modes.....	20
Cooking times table.....	20
How to operate the top oven .....	21
Cooking times table.....	21
How to operate the top grill.....	22
Top oven cooking times table for grilling .....	22

### **7 Maintenance and care 23**

General information.....	23
Cleaning the hob.....	23
Cleaning the control panel .....	23
Cleaning the oven .....	23
Removing the top oven door.....	24
Removing the door inner glass .....	25
Replacing the oven lamp.....	26

### **8 Troubleshooting 27**

### **9 Guarantee Details 28**

## **1 Important instructions and warnings for safety and environment**

This section contains safety instructions that will help protect from risk of personal injury or property damage. Failure to follow these instructions shall void any warranty.

### **General safety**

- This appliance can be used by children aged from 8 years and above and persons with reduced physical, sensory or mental capabilities or lack of experience and knowledge if they have been given supervision or instruction concerning use of the appliance in a safe way and understand the hazards involved.

Children shall not play with the appliance. Cleaning and user maintenance shall not be made by children without supervision.

- The appliance is not to be used by persons (including children) with reduced physical, sensory or mental capabilities, or lack of experience and knowledge, unless they have been given supervision or instruction. Children being supervised not to play with the appliance.
- If the product is handed over to someone else for personal use or second-hand use purposes, the user manual, product labels and

other relevant documents and parts should be also given.

- Never place the product on a carpet-covered floor. Otherwise, lack of airflow beneath the product will cause electrical parts to overheat. This will cause problems with your product.
- Installation and repair procedures must always be performed by Authorized Service Agents. The manufacturer shall not be held responsible for damages arising from procedures carried out by unauthorized persons which may also void the warranty. Before installation, read the instructions carefully.
- Do not operate the product if it is defective or has any visible damage.
- Ensure that the product function knobs are switched off after every use.

### **Electrical safety**

- If the product has a failure, it should not be operated unless it is repaired by an Authorized Service Agent. There is the risk of electric shock!
- Only connect the product to a grounded outlet/line with the voltage and protection as

specified in the “Technical specifications”. Have the grounding installation made by a qualified electrician while using the product with or without a transformer. Our company shall not be liable for any problems arising due to the product not being earthed in accordance with the local regulations.

- Never wash the product by spreading or pouring water onto it! There is the risk of electric shock!
- The product must be disconnected during installation, maintenance, cleaning and repairing procedures.
- If the power connection cable for the product is damaged, it must be replaced by the manufacturer, its service agent or similarly qualified persons in order to avoid a hazard.
- Only use the connection cable specified in the “Technical specifications”.
- The appliance must be installed so that it can be completely disconnected from the mains supply. The separation must be provided by a switch built into the fixed electrical installation, according to construction regulations.
- Rear surface of the oven gets hot when it is in use. Make sure that

the electrical connection does not contact the rear surface; otherwise, connections can get damaged.

- Do not trap the mains cable between the oven door and frame and do not route it over hot surfaces. Otherwise, cable insulation may melt and cause fire as a result of short circuit.
- Any work on electrical equipment and systems should only be carried out by authorized and qualified persons.
- In case of any damage, switch off the product and disconnect it from the mains. To do this, turn off the fuse at home.
- Make sure that fuse rating is compatible with the product.

### **Product safety**

- **WARNING:** The appliance and its accessible parts become hot during use. Care should be taken to avoid touching heating elements. Children less than 8 years of age shall be kept away unless continuously supervised.
- Never use the product when your judgment or coordination is impaired by the use of alcohol and/or drugs.
- Be careful when using alcoholic drinks in your dishes. Alcohol evaporates at high temperatures and may cause fire since it can

ignite when it comes into contact with hot surfaces.

- Food Poisoning Hazard: Do not let food sit in oven for more than 1 hour before or after cooking. Doing so can result in food poisoning or sickness.
- Do not place any flammable materials close to the product as the sides may become hot during use.
- During use the appliances becomes hot. Care should be taken to avoid touching heating elements inside the oven.
- Keep all ventilation slots clear of obstructions.
- Do not heat closed tins and glass jars in the oven. The pressure that would build-up in the tin/jar may cause it to burst.
- Do not place baking trays, dishes or aluminium foil directly onto the bottom of the oven. The heat accumulation might damage the bottom of the oven.
- Do not use harsh abrasive cleaners or sharp metal scrapers to clean the oven door glass since they can scratch the surface, which may result in shattering of the glass.
- Do not use steam cleaners to clean the appliance as this may cause an electric shock.

- (Varies depending on the product model.)

Placing the wire shelf and tray onto the wire racks properly. It is important to place the wire shelf and/or tray onto the rack properly. Slide the wire shelf or tray between 2 rails and make sure that it is balanced before placing food on it (Please see the following figure).

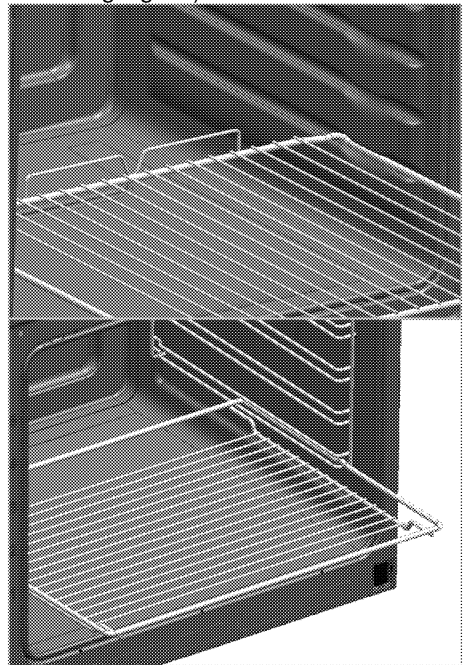

- Do not use the product if the front door glass removed or cracked.
- Do not use the oven handle to hang towels for drying. Do not hang up towel, gloves, or similar textile products when the grill function is at open door.

- Always use heat resistant oven gloves when putting in or removing dishes into/from the hot oven.
- Place the baking paper into the cooking pot or on to the oven accessory (tray, wire grill etc) together with the food and then insert all into the preheated oven. Remove the excess parts of the baking paper overflowing from the accessory or the pot in order to prevent the risk of touching the oven's heating elements. Never use the baking paper in an operating temperature higher than the indicated value for the baking paper. Do not place the baking paper directly on the base of the oven.
- **WARNING:** Ensure that the appliance is switched off before replacing the lamp to avoid the possibility of electric shock.
- The appliance must not be installed behind a decorative door in order to avoid overheating.
- Product must be placed directly on the floor. It must not be placed onto a base or a pedestal.
- **WARNING:** Unattended cooking on a hob with fat or oil can be dangerous and may result in fire. NEVER try to extinguish a fire with water, but switch off the appliance and then cover flame e.g. with a lid or a fire blanket.
- **CAUTION:** The cooking process has to be supervised. A short term cooking process has to be supervised continuously.
- **WARNING:** Danger of fire: Do not store items on the cooking surfaces.
- **WARNING:** If the surface is cracked, switch off the appliance to avoid the possibility of electric shock.
- In case of hotplate glass breakage : Shut immediately off all burners and any electrical heating element and isolate the appliance from the power supply. Do not touch the appliance surface. Do not use the appliance.
- The appliance is not intended to be operated by means of an external timer or separate remote-control system.
- Vapour pressure that build up due to the moisture on the hob surface or at the bottom of the pot can cause the pot to move. Therefore, make sure that the oven surface and bottom of the pots are always dry.
- **WARNING:** Use only hob guards designed by the manufacturer of the cooking appliance or indicated by the manufacturer of the appliance in the instructions

for use as suitable or hob guards incorporated in the appliance. The use of inappropriate guards can cause accidents.

Prevention against possible fire risk!

- Ensure all electrical connections are secure and tight to prevent risk of arcing.
- Do not use damaged cables or extension cables.
- Ensure liquid or moisture is not accessible to the electrical connection point.

### **Intended use**

- This product is designed for domestic use. Commercial use will void the guarantee.
- This appliance is for cooking purposes only. It must not be used for other purposes, for example room heating.
- This product should not be used for warming the plates under the grill, drying towels, dish cloths etc. by hanging them on the oven door handles. This product should also not be used for room heating purposes.
- The manufacturer shall not be liable for any damage caused by improper use or handling errors.
- The oven can be used for defrosting, baking, roasting and grilling food.

### **Safety for children**

- **WARNING:** Accessible parts may become hot during use. Young children should be kept away.
- The packaging materials will be dangerous for children. Keep the packaging materials away from children. Please dispose of all parts of the packaging according to environmental standards.
- Electrical products are dangerous to children. Keep children away from the product when it is operating and do not allow them to play with the product.
- Do not place any items above the appliance that children may reach for.
- When the door is open, do not load any heavy object on it and do not allow children to sit on it. It may overturn or door hinges may get damaged.



## Disposing of the old product

### Compliance with the WEEE Directive and Disposing of the Waste Product:



This product complies with EU WEEE Directive (2012/19/EU). This product bears a classification symbol for waste electrical and electronic equipment (WEEE).

This product has been manufactured with high quality parts and materials which can be reused and are suitable for recycling. Do not dispose of the waste product with normal domestic and other wastes at the end of its service life. Take it to the collection center for the recycling of electrical and electronic equipment. Please consult your local authorities to learn about these collection centers.

### Compliance with RoHS Directive:

The product you have purchased complies with EU RoHS Directive (2011/65/EU). It does not contain harmful and prohibited materials specified in the Directive.

### Package information

- Packaging materials of the product are manufactured from recyclable materials in

accordance with our National Environment Regulations. Do not dispose of the packaging materials together with the domestic or other wastes. Take them to the packaging material collection points designated by the local authorities.

### Future Transportation

- Keep the product's original carton and transport the product in it. Follow the instructions on the carton. If you do not have the original carton, pack the product in bubble wrap or thick cardboard and tape it securely.
- To prevent the wire grill and tray inside the oven from damaging the oven door, place a strip of cardboard onto the inside of the oven door that lines up with the position of the trays. Tape the oven door to the side walls.
- Do not use the door or handle to lift or move the product.

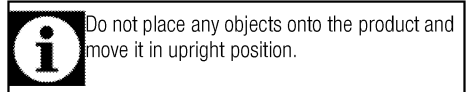

Do not place any objects onto the product and move it in upright position.



Check the general appearance of your product for any damages that might have occurred during transportation.

## 2 General information

### Overview

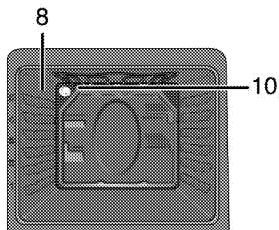
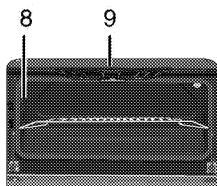
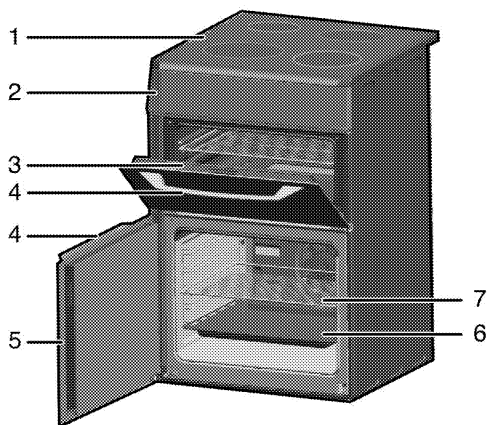

- |   |                |    |                       |
|---|----------------|----|-----------------------|
| 1 | Burner plate   | 6  | Tray                  |
| 2 | Control panel  | 7  | Wire shelf            |
| 3 | Grill door     | 8  | Shelf positions       |
| 4 | Handle         | 9  | Grill heating element |
| 5 | Main oven door | 10 | Lamp                  |

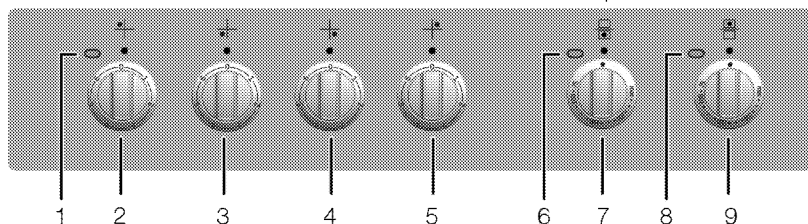

- |   |  |
|---|--|
| 1 | Warning lamp                             |
| 2 | Single-circuit cooking plate Rear left   |
| 3 | Single-circuit cooking plate Front left  |
| 4 | Single-circuit cooking plate Front right |
| 5 | Single-circuit cooking plate Rear right  |
| 6 | Thermostat lamp for main oven            |
| 7 | Main oven function knob                  |
| 8 | Thermostat lamp for top oven             |
| 9 | Top oven thermostat knob                 |

## Package contents



Accessories supplied can vary depending on the product model. Not every accessory described in the user manual may exist on your product.

1. **User manual**

2. **Oven tray**

Used for pastries, frozen foods and big roasts.

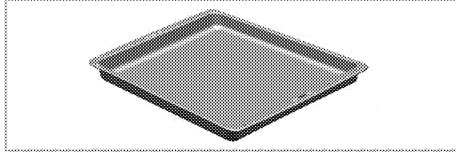

3. **Wire Shelf**

Used for roasting and for placing the food to be baked, roasted or cooked in casserole dishes to the desired rack.

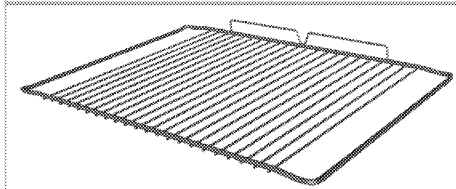
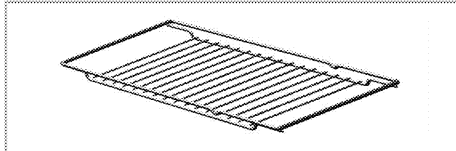

4. **Small wire shelf**

It is placed into the tray (if supplied) in order to collect the dripping fat while grilling so that the oven is kept clean.

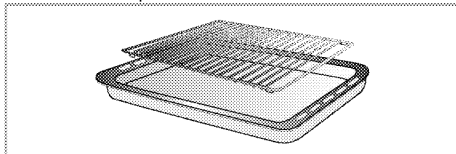

5. **Placing the wire shelf and tray onto the telescopic racks properly**  
**(This feature is optional. It may not exist on your product.)**

Telescopic racks allow you to install and remove the trays and wire shelf easily.

When using the tray and wire shelf with telescopic racks, make sure that the pins at the rear section of the telescopic rack stands against the edges of the wire shelf and tray.

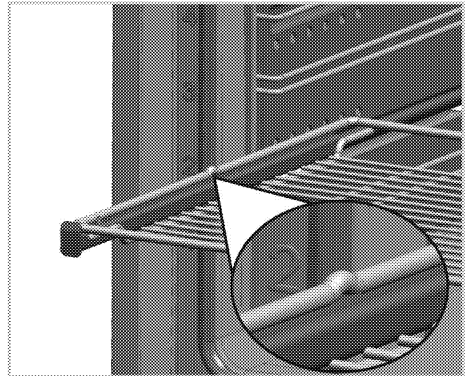
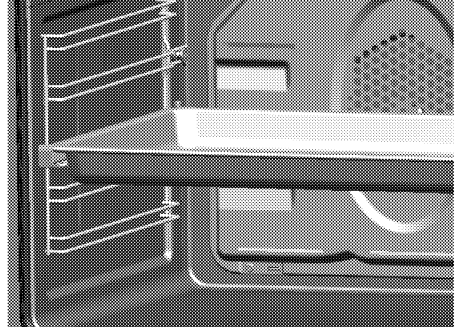

## Technical specifications

GENERAL	
External dimensions (height / width / depth)	900 mm/500 mm/600 mm
Voltage / frequency	220 - 240 V ~ 50 Hz
Total power consumption	9.4 kW
Fuse	32 A
Cable type / section	min.H05VV-FG 3 x 4 mm <sup>2</sup> or equivalent
HOB	
Burners	
Rear left	<b>Single-circuit cooking plate</b>
Dimension	140 mm
Power	1200 W
Front left	<b>Single-circuit cooking plate</b>
Dimension	180 mm
Power	1700 W
Front right	<b>Single-circuit cooking plate</b>
Dimension	140 mm
Power	1200 W
Rear right	<b>Single-circuit cooking plate</b>
Dimension	180 mm
Power	1700 W
OVEN/GRILL	
Top oven	<b>Conventional oven</b>
Grill power consumption	1.6 kW
Main oven	<b>Fan oven</b>
Inner lamp	15–25 W

# Basics: Information on the energy label of electrical ovens is given in accordance with the EN 60350-1 / IEC 60350-1 standard. Those values are determined under standard load with bottom-top heater or fan assisted heating (if any) functions.

Energy efficiency class is determined in accordance with the following prioritization depending on whether the relevant functions exist on the product or not. 1-Cooking with eco-fan, 2- Turbo slow cooking, 3- Turbo cooking, 4- Fan assisted bottom/top heating, 5-Top and bottom heating.



Technical specifications may be changed without prior notice to improve the quality of the product.



Figures in this manual are schematic and may not exactly match your product.



Values stated on the product labels or in the documentation accompanying it are obtained in laboratory conditions in accordance with relevant standards. Depending on operational and environmental conditions of the product, these values may vary.

### 3 Installation

Product must be installed by a qualified person in accordance with the regulations in force. The manufacturer shall not be held responsible for damages arising from procedures carried out by unauthorized persons which may also void the warranty.



Preparation of location and electrical installation for the product is under the installer's responsibility.



#### DANGER:

The product must be installed in accordance with all local electrical regulations.



#### DANGER:

Prior to installation, visually check if the product has any defects on it. If so, do not have it installed.

Damaged products cause risks for your safety.

#### Before installation

To ensure that critical air gaps are maintained under the appliance, we recommend that this appliance is mounted on a solid base and that the feet do not sink into any carpet or soft flooring.

The kitchen floor must be able to carry the weight of the appliance plus the additional weight of cookware and bakeware and food.

If the range is placed on a base, measures have to be taken to prevent the appliance slipping from the base.

The appliances must not be installed behind a decorative door in order to avoid overheating.

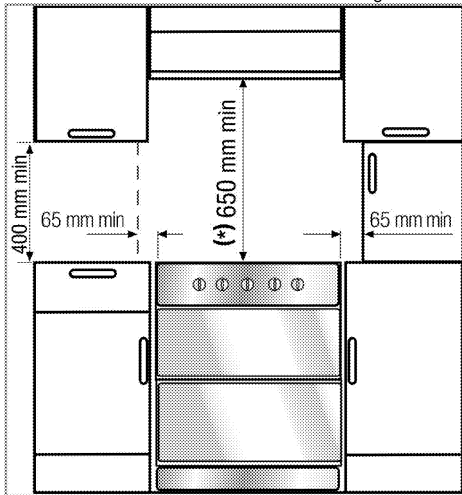

- It can be used with cabinets on either side but in order to have a minimum distance of 400mm above hotplate level allow a side clearance of 65mm between the appliance and any wall, partition or tall cupboard.
- It can also be used in a free standing position. Allow a minimum distance of 650 mm above the hob surface.
- (\*) If a cooker hood is to be installed above the cooker, refer to cooker hood manufacturer' instructions regarding installation height (min 650 mm).
- Movement of your appliance is most easily achieved by lifting the front as follows and pulling towards. Open the top oven door and the bottom oven door sufficiently to allow a comfortable grip on the underside front edge of the oven roofs. While gripping, it should be avoided to damage any grill elements or oven interior furniture.
- The appliance corresponds to device class 1, i.e. it may be placed with the rear and **one** side to kitchen walls, kitchen furniture or equipment of any size. The kitchen furniture or equipment on the **other** side may only be of the same size or smaller.
- Any kitchen furniture next to the appliance must be heat-resistant (100 °C min.).

#### Safety chain

The appliance must be secured against overbalancing by using the supplied two safety chains on your oven. Fasten hook (1) by using a proper peg to the kitchen wall (6) and connect safety chain (3) to the hook via the locking mechanism (2).

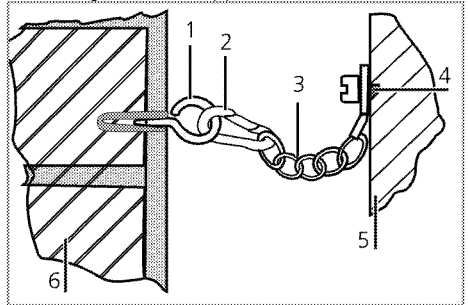

- 1 Stability hook
- 2 Locking mechanism
- 3 Safety chain (supplied and mounted to oven)
- 4 Firmly fix chain to cooker rear

- 5 Rear of cooker
- 6 Kitchen wall

 Stability chain to be as short as practicable to avoid oven tilting forward and diagonal to avoid oven side tilting.

Cooker stability chain for cookers not designed with bracket engagement slot.

### Installation and connection

Product can only be installed and connected in accordance with the statutory installation rules.

 Do not install the product next to refrigerators or freezers. The heat emitted by the product will increase the energy consumption of cooling appliances.

- Carry the product with at least two persons.
- Product must be placed directly on the floor. It must not be placed onto a base or a pedestal.

 Do not use the door and/or handle to carry or move the product. The door, handle or hinges get damaged.

### Electrical connection

Connect the product to a grounded outlet/line protected by a fuse of suitable capacity as stated in the "Technical specifications" table. Have the grounding installation made by a qualified electrician while using the product with or without a transformer. Our company shall not be liable for any damages that will arise due to using the product without a grounding installation in accordance with the local regulations.

 **DANGER:**  
The product must be connected to the mains supply only by an authorised and qualified person..  
Manufacturer shall not be held responsible for damages arising from procedures carried out by unauthorised persons.

 **DANGER:**  
The power cable must not be clamped, bent or trapped or come into contact with hot parts of the product.  
A damaged power cable must be replaced by a qualified electrician. Otherwise, there is risk of electric shock, short circuit or fire!

The mains supply data must correspond to the data specified on the type label of the product. The rating plate is either seen when the door or the lower cover is

opened or it is located at the rear wall of the unit depending on the unit type.  
Power cable of your product must comply with the values in "Technical specifications" table.

 **DANGER:**  
Before starting any work on the electrical installation, disconnect the product from the mains supply.  
There is the risk of electric shock!

### Connecting the power cable

#### Connecting the power cable

1. If a power cable is not supplied together with your product, a power cable that you would select from the table in accordance with the electrical installation at your home must be connected to your product by following the instructions in cable diagram. (Please consider technical data table, *Technical specifications, page 12*)

This product must only be installed by a qualified electrician eg local electricity company or NICEIC registered contractor to a suitable double-pole control unit with a minimum contact clearance of 3mm in all poles and with a minimum rating please consider technical data table, *Technical specifications, page 12* which should be fitted adjacent to (but not above) the cooker in accordance with IEE regulations. Failure to observe this instruction may result in operational problems and invalidation of the product warranty.

 Additional protection by a residual current circuit breaker is recommended.

2. The cable must have conductors of sufficiently high cross sectional area to prevent overheating and deterioration.

The mains cable must conform to BS6004. This appliance must be earthed.

The mains cable must pass through the cable clamp. The mains cable should be routed away from the appliance and in particular ventilation slots, the vent outlet and should not be obstructed when pushed in to position between the appliance and the wall and/or cabinets.

3. Open the terminal block cover with a screwdriver.
4. Insert the power cable through the cable clamp below the terminal and secure it to the main body with the integrated screw on cable clamping component.
5. Connect the cables according to the supplied diagram.

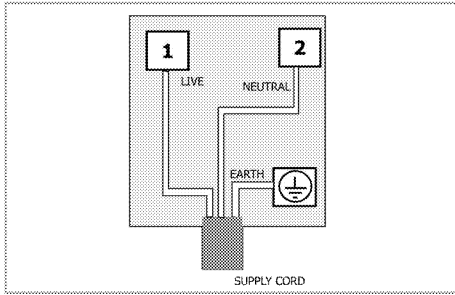

6. After completing the wire connections, close the terminal block cover.
7. Route the power cable so that it will not contact the product and get squeezed between the product and the wall.



Power cable must not be longer than 2m because of safety reasons.

- Push the product towards the kitchen wall.
- **Adjusting the feet of oven**  
Vibrations during use may cause cooking vessels to move. This dangerous situation can be avoided if the product is level and balanced. For your own safety please ensure the product is level by adjusting the four feet at the bottom by turning left or right and align level with the work top.

#### **Final check**

1. Reconnect the product to the mains.
2. Check electrical functions.

## 4 Preparation

### Tips for saving energy

The following information will help you to use your appliance in an ecological way, and to save energy:

- Use dark coloured or enamel coated cookware in the oven since the heat transmission will be better.
- While cooking your dishes, perform a preheating operation if it is advised in the user manual or cooking instructions.
- Do not open the door of the oven frequently during cooking.
- Try to cook more than one dish in the oven at the same time whenever possible. You can cook by placing two cooking vessels onto the wire shelf.
- Cook more than one dish one after another. The oven will already be hot.
- You can save energy by switching off your oven a few minutes before the end of the cooking time. Do not open the oven door.
- Defrost frozen dishes before cooking them.
- Use pots/pans with cover for cooking. If there is no cover, energy consumption may increase 4 times.
- Select the burner which is suitable for the bottom size of the pot to be used. Always select the correct pot size for your dishes. Larger pots require more energy.
- Pay attention to use flat bottom pots when cooking with electric hobs. Pots with thick bottom will provide a better heat conduction. You can obtain energy savings up to 1/3.
- Vessels and pots must be compatible with the cooking zones. Bottom of the vessels or pots must not be smaller than the hotplate.
- Keep the cooking zones and bottom of the pots clean. Dirt will decrease the heat conduction between the cooking zone and bottom of the pot.
- For long cookings, turn off the cooking zone 5 or 10 minutes before the end of cooking time. You can obtain energy savings up to 20% by using the residual heat.

### Initial use

#### First cleaning of the appliance



The surface might get damaged by some detergents or cleaning materials.

Do not use aggressive detergents, cleaning powders/creams or any sharp objects during cleaning.

Do not use harsh abrasive cleaners or sharp metal scrapers to clean the oven door glass since they can scratch the surface, which may result in shattering of the glass.

1. Remove all packaging materials.
2. Wipe the surfaces of the appliance with a damp cloth or sponge and dry with a cloth.

#### Initial heating

Heat up the product for about 30 minutes and then switch it off. Thus, any production residues or layers will be burnt off and removed.



#### WARNING

Hot surfaces cause burns!

Product may be hot when it is in use. Never touch the hot burners, inner sections of the oven, heaters and etc. Keep children away. Always use heat resistant oven gloves when putting in or removing dishes into/from the hot oven.

#### Electric oven

1. Take all baking trays and the wire grill out of the oven.
2. Close the oven door.
3. Select the highest oven power; See *How to operate the electric oven, page 19*.
4. Operate the oven for about 30 minutes.
5. Turn off your oven; See *How to operate the electric oven, page 19*

#### Grill oven

1. Take all baking trays and the wire grill out of the oven.
2. Close the oven door.
3. Select the highest oven power for grill oven; see .
4. Operate the grill about 30 minutes.
5. Turn off your grill; see



Smoke and smell may emit for a couple of hours during the initial operation. This is quite normal. Ensure that the room is well ventilated to remove the smoke and smell. Avoid directly inhaling the smoke and the smell that emits.



## 5 How to use the hob

### General information about cooking



Never fill the pan with oil more than one third of it. Do not leave the hob unattended when heating oil. Overheated oils bring risk of fire. **Never attempt to extinguish a possible fire with water!** When oil catches fire, cover it with a fire blanket or damp cloth. Turn off the hob if it is safe to do so and call the fire department.

- Before frying foods, always dry them well and gently place into the hot oil. Ensure complete thawing of frozen foods before frying.
- Do not cover the vessel you use when heating oil.
- Place the pans and saucepans in a manner so that their handles are not over the hob to prevent heating of the handles. Do not place unbalanced and easily tilting vessels on the hob.
- Do not place empty vessels and saucepans on cooking zones that are switched on. They might get damaged.
- Operating a cooking zone without a vessel or saucepan on it will cause damage to the product. Turn off the cooking zones after the cooking is complete.
- As the surface of the product can be hot, do not put plastic and aluminum vessels on it. Clean any melted such materials on the surface immediately. Such vessels should not be used to keep foods either.
- Use flat bottomed saucepans or vessels only.
- Put appropriate amount of food in saucepans and pans. Thus, you will not have to make any unnecessary cleaning by preventing the dishes from overflowing. Do not put covers of saucepans or pans on cooking zones. Place the saucepans in a manner so that they are centered on the cooking zone. When you want to move the saucepan onto another cooking zone, lift and place it onto the cooking zone you want instead of sliding it.

### Tips about glass ceramic hobs

- Glass ceramic surface is heatproof and is not affected by big temperature differences.

- Do not use the glass ceramic surface as a place of storage or as a cutting board.
- Use only the saucepans and pans with machined bottoms. Sharp edges create scratches on the surface.
- Do not use aluminum vessels and saucepans. Aluminum damages the glass ceramic surface.

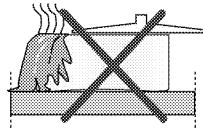

Spills may damage the glass ceramic surface and cause fire.

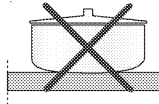

Do not use vessels with concave or convex bottoms.

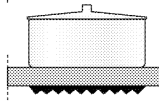

Use only the saucepans and pans with flat bottoms. They ensure easier heat transfer. If the diameter of the saucepan is too small, energy will be wasted.

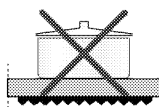

### Using the hobs

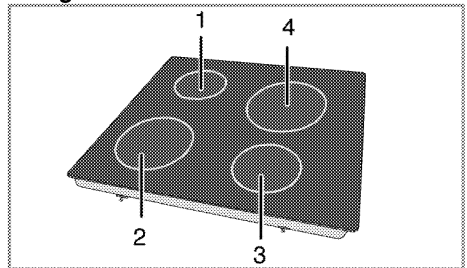

list of advised diameter of pots to be used on related burners.

- 1 Single-circuit cooking plate 14-16 cm
- 2 Single-circuit cooking plate 18-20 cm
- 3 Single-circuit cooking plate 14-16 cm
- 4 Single-circuit cooking plate 18-20 cm

**DANGER:**

Do not allow any object to drop on the hob. Even small objects such as a saltshaker may damage the hob.

Do not use cracked hobs. Water may leak through these cracks and cause short circuit. In case of any kind of damage on the surface (eg., visible cracks), switch off the product immediately to minimize the risk of electric shock.

Glass ceramic hob is equipped with an operation light and a hot zone warning indicator.

Hot zone warning indicator indicates the status of the active zone and it remains lit after the plate is turned off. When the temperature of the plate cools down to a level that it can be touched by hand, warning indicator turns off. Flickering of the hot zone warning indicator is not a failure.

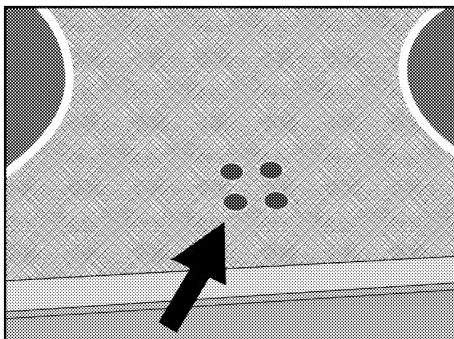

Quick heating glass-ceramic hobs emit a bright light when they are switched on. Do not stare at the bright light.

**Turning on the ceramic plates**

The hob control knobs are used for operating the plates. To obtain the desired cooking power, turn the hob control knobs to the corresponding level.

<b>Cooking level</b>	<b>1</b>	<b>2 — 3</b>	<b>4 — 6</b>
	warming	stewing, simmering	cooking, boiling

**Turning off the ceramic plates**

Turn the plate knob to OFF (upper) position.

## 6 How to operate the oven

### General information on baking, roasting and grilling



#### WARNING

Hot surfaces cause burns!  
Product may be hot when it is in use. Never touch the hot burners, inner sections of the oven, heaters and etc. Keep children away. Always use heat resistant oven gloves when putting in or removing dishes into/from the hot oven.



#### DANGER:

Be careful when opening the oven door as steam may escape.  
Exiting steam can scald your hands, face and/or eyes.

#### Tips for baking

- Use non-sticky coated appropriate metal plates or aluminum vessels or heat-resistant silicone moulds.
- Make best use of the space on the rack.
- Place the baking mould in the middle of the shelf.
- Select the correct rack position before turning the oven or grill on. Do not change the rack position when the oven is hot.
- Keep the oven door closed.

#### Tips for roasting

- Treating whole chicken, turkey and large piece of meat with dressings such as lemon juice and black pepper before cooking will increase the cooking performance.
- It takes about 15 to 30 minutes longer to roast meat with bones when compared to roasting the same size of meat without bones.
- Each centimeter of meat thickness requires approximately 4 to 5 minutes of cooking time.
- Let meat rest in the oven for about 10 minutes after the cooking time is over. The juice is better distributed all over the roast and does not run out when the meat is cut.
- Fish should be placed on the middle or lower rack in a heat-resistant plate.

#### Tips for grilling

When meat, fish and poultry are grilled, they quickly get brown, have a nice crust and do not get dry. Flat pieces, meat skewers and sausages are particularly suited for grilling as are vegetables with high water content such as tomatoes and onions.

- Distribute the pieces to be grilled on the wire shelf or in the baking tray with wire shelf in such a way that the space covered does not exceed the size of the heater.
- Slide the wire shelf or baking tray with grill into the desired level in the oven. If you are grilling on the wire shelf, slide the baking tray to the lower rack to collect fats. Add some water in the tray for easy cleaning.



Foods that are not suitable for grilling carry the risk of fire. Only grill food which is suitable for intensive grilling heat.

Do not place the food too far in the back of the grill. This is the hottest area and fatty food may catch fire.

### How to operate the electric oven

Product is equipped with two ovens. Overview section indicates the relevant knobs for each oven.

#### How to operate the main oven

#### Select temperature and operating mode/ Easy

#### Steam Cleaning

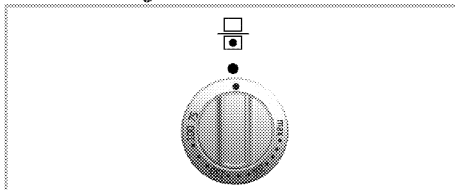

1. Set the Function knob to the desired temperature.  
» Oven heats up to the adjusted temperature and maintains it. During heating, temperature lamp stays on.

This function must be used for easy steam cleaning as well.

#### Switching off the electric oven

Turn the Function knob to Off (top) position.

#### Rack positions (For models with wire shelf)

It is important to place the wire shelf onto the side rack correctly. Wire shelf must be inserted between the side racks as illustrated in the figure.

Do not let the wire shelf stand against the rear wall of the oven. Slide your wire shelf to the front section of the rack and settle it with the help of the door in order to obtain a good grill performance.

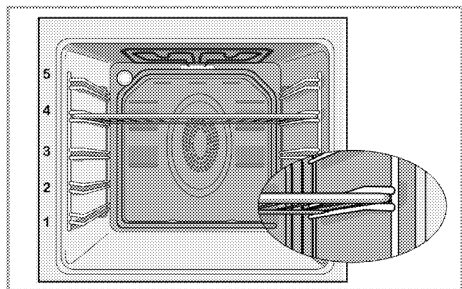

## Operating modes

All functions in your oven (including the main oven) are described in this section.

The order of operating modes shown here may be different from the arrangement on your product.

## Cooking times table



The timings in this chart are meant as a guide. Timings may vary due to temperature of food, thickness, type and your own preference of cooking.

## Baking and roasting



1st rack of the oven is the **bottom** rack.

Dish	Cooking level number	Rack position	Temperature (°C)	Cooking time (approx. in min.)
Cakes in tray*	One level	3	175	30 ... 45
Cakes in mould*	One level	2	175	30 ... 50
Cakes in cooking paper*	One level	3	160 ... 170	20 ... 30
Sponge cake*	One level	3	180 ... 200	10 ... 20
Cookies*	One level	3	160 ... 170	20 ... 30
Dough pastry*	One level	3	200	20 ... 30
Rich pastry*	One level	3	190	20 ... 35
Leaven*	One level	3	190	20 ... 40
Lasagna*	One level	3	180	25 ... 45
Beef steak (whole) / Roast	One level	2	25 min. 220, then 180 ... 190	80 ... 120
Leg of Lamb (casserole)	One level	2	25 min. 220 then 180 ... 190	70 ... 100
Roasted chicken	One level	2	15 min. 220, then 190	55 ... 75
Turkey (Sliced)	One level	3	25 min. 220, then 190	70 ... 120
Fish	One level	3	200	20 ... 30

(\*\*) In a cooking that requires preheating, preheat at the beginning of cooking until the thermostat lamp turns off.

### Tips for baking cake

- If the cake is too dry, increase the temperature by 10°C and decrease the cooking time.
- If the cake is wet, use less liquid or lower the temperature by 10°C.
- If the cake is too dark on top, place it on a lower rack, lower the temperature and increase the cooking time.
- If cooked well on the inside but sticky on the outside use less liquid, lower the temperature and increase the cooking time.

### Tips for baking pastry

- If the pastry is too dry, increase the temperature by 10°C and decrease the cooking time. Dampen the layers of dough with a sauce composed of milk, oil, egg and yoghurt.

- If the pastry takes too long to bake, pay care that the thickness of the pastry you have prepared does not exceed the depth of the tray.
- If the upper side of the pastry gets browned, but the lower part is not cooked, make sure that the amount of sauce you have used for the pastry is not too much at the bottom of the pastry. Try to scatter the sauce equally between the dough layers and on the top of pastry for an even browning.



Cook the pastry in accordance with the mode and temperature given in the cooking table. If the bottom part is still not browned enough, place it on one lower rack next time.

### Tips for cooking vegetables

- If the vegetable dish runs out of juice and gets too dry, cook it in a pan with a lid instead of a tray. Closed vessels will preserve the juice of the dish.

- If a vegetable dish does not get cooked, boil the vegetables beforehand or prepare them like canned food and put in the oven.

### How to operate the top oven

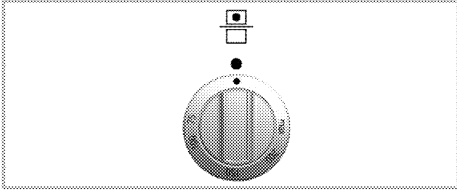

Grill oven can be used both as a grill and a baking oven. Switch on the top oven operates the oven when the oven door is closed, and the grill when the oven door is opened.

#### Turning on the oven

Oven is operated with Function knob. Oven is turned off when the Function knob is in Off (upper) position.

1. Close the oven door.
  2. Set the oven temperature.
- » Temperature light will turn of when the set temperature is attained.

#### Turning off the grill oven

1. Turn the Function knob to Off (top) position.

#### Cooking times table

**i** The timings in this chart are meant as a guide. Timings may vary due to temperature of food, thickness, type and your own preference of cooking.

**i** Maximum load capacity of oven tray: 4 kg (8.8 lb).

**i** 1st rack of the oven is the **bottom** rack.

- Do not place cookware with rough bases on the oven door.

- Ensure that there is at least 25mm space at top of oven when cooking larger foods or using taller cookware.

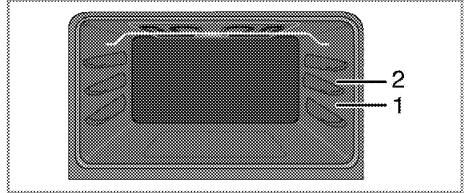

It is important to position the wire grill on the wire shelf correctly. The wire grill must be placed so that it will fit into the opening of the wire shelf as illustrated in the figure.

When removing tray from top oven, pull as shown in picture and hold with two hands from two sides.

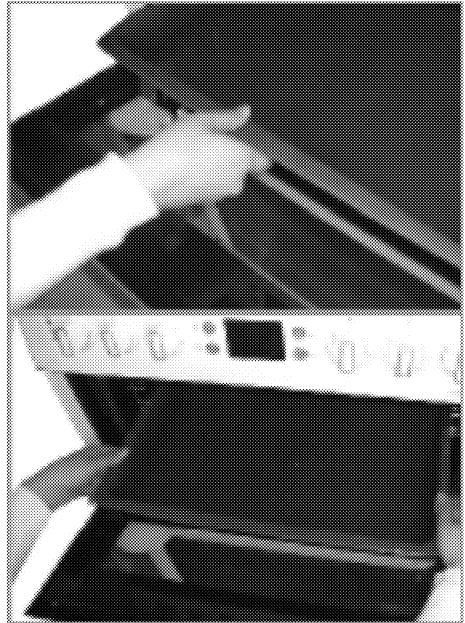

## Baking and roasting

Food	Cooking level number	Rack position	Temperature (°C)	Cooking time
Fruit pies	One level	1	175	25...35 min.
Pizza	One level	1	200	15...20 min. depending on thickness
Small cakes	One level	1	160...170	25...35 min.
Victoria sandwich	One level	1	160...170	20...40 min.
Biscuits	One level	1	160...170	15...30 min.
Scones	One level	1	190	20...30 min.
Casseroles	One level	1	160	2...3 hours
Whole fish	One level	1	180	25...35 min.
Pasta bake	One level	1	170...180	20...40 min.
Roast Beef	One level	1	160...170	20...40 min. per 450 g + 15 min.

## How to operate the top grill



### WARNING

Hot surfaces may cause burns! Children must be kept away.

**When the door fully open, it remains tilted slightly, so that any spillage will be directed away from you.**



### WARNING

This product is designed for OPEN DOOR GRILLING.

Grill oven can be used both as a grill and a baking oven. Switch on the top oven operates the oven when the oven door is closed, and the grill when the oven door is opened.

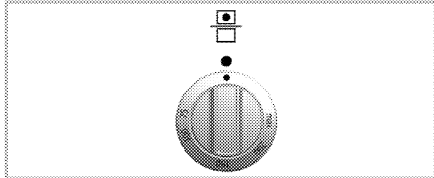

## Switching on the grill

Grill is operated with Function knob. Grill is turned off when the Function knob is in Off (upper) position.

1. Open the oven / grill door.
2. Set the temperature to "max" and if required, perform a preheating for about 5 minutes.
3. Then, select the desired grilling temperature.  
» Thermostat (temperature) light turns on.

## Turning off the grill oven

1. Turn the Function knob to Off (top) position.

- Put big or medium-sized portions in correct rack position under the grill heater for grilling.
- For food only whose top is required to be roasted, grill the food either by placing onto the wire grill in the tray or by placing the tray onto the floor of grilling compartment.
- Food and plates placed onto the floor of grill compartment will get heated when the main oven is in use. Do not switch on the grill compartment when using it for storing food.

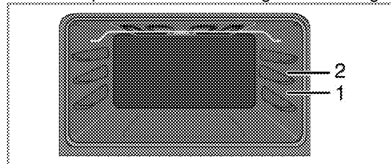

Foods that are not suitable for grilling carry the risk of fire. Only grill food which is suitable for intensive grilling heat.

Do not place the food too far in the back of the grill. This is the hottest area and fatty food may catch fire.

## Top oven cooking times table for grilling

### Grilling with electric grill



1st rack of the oven is the **bottom** rack.

Food	Insertion level	Grilling time (approx.)
Fish	1	20...25 min. #
Sliced chicken	1	25...35 min.
Lamb chops	1	20...25 min.
Roast beef	1	25...30 min. #
Veal chops	1	25...30 min. #
Toast bread	2	1...3 min.

# depending on thickness

## 7 Maintenance and care

### General information

Service life of the product will extend and the possibility of problems will decrease if the product is cleaned at regular intervals.

**DANGER:**

Disconnect the product from mains supply before starting maintenance and cleaning works.

There is the risk of electric shock!

**DANGER:**

Allow the product to cool down before you clean it.

Hot surfaces may cause burns!

- Clean the product thoroughly after each use. In this way it will be possible to remove cooking residues more easily, thus avoiding these from burning the next time the appliance is used.
- No special cleaning agents are required for cleaning the product. Use warm water with washing liquid, a soft cloth or sponge to clean the product and wipe it with a dry cloth.
- Always ensure any excess liquid is thoroughly wiped off after cleaning and any spillage is immediately wiped dry.
- Do not use cleaning agents that contain acid or chloride to clean the stainless or inox surfaces and the handle. Use a soft cloth with a liquid detergent (not abrasive) to wipe those parts clean, paying attention to sweep in one direction.



The surface might get damaged by some detergents or cleaning materials.

Do not use aggressive detergents, cleaning powders/creams or any sharp objects during cleaning.

Do not use harsh abrasive cleaners or sharp metal scrapers to clean the oven door glass since they can scratch the surface, which may result in shattering of the glass.



Do not use steam cleaners to clean the appliance as this may cause an electric shock.

### Cleaning the hob

#### Glass ceramic surfaces

Wipe the glass ceramic surface using a piece of cloth dampened with cold water in a manner as not to leave any cleaning agent on it. Dry with a soft and dry cloth.

Residues may cause damage on the glass ceramic surface when using the hob for the next time.

Dried residues on the glass ceramic surface should under no circumstances be scraped with hook blades, steel wool or similar tools.

Remove calcium stains (yellow stains) by a small amount of lime remover such as vinegar or lemon juice. You can also use suitable commercially available products.

If the surface is heavily soiled, apply the cleaning agent on a sponge and wait until it is absorbed well. Then, clean the surface of the hob with a damp cloth.



Sugar-based foods such as thick cream and syrup must be cleaned promptly without waiting the surface to cool down. Otherwise, glass ceramic surface may be damaged permanently.

Slight color fading may occur on coatings or other surfaces in time. This will not affect operation of the product.

Color fading and stains on the glass ceramic surface is a normal condition, and not a defect.

### Cleaning the control panel

Clean the control panel and knobs with a damp cloth and wipe them dry.



Do not remove the control buttons/knobs to clean the control panel. Control panel may get damaged!

### Cleaning the oven

#### To clean the side wall

(This feature is optional. It may not exist on your product.)

1. Remove the front section of the side rack by pulling it in the opposite direction of the side wall.
2. Remove the side rack completely by pulling it towards you.

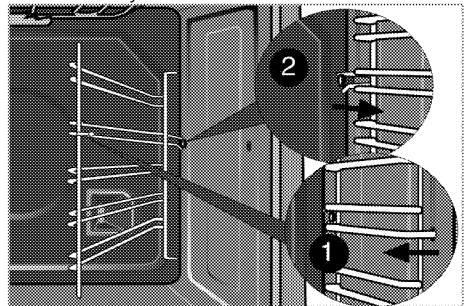

## Catalytic walls

(This feature is optional. It may not exist on your product.)

The inner side walls (A) and/or the rear wall (B) of your product may be coated with catalytic enamel. Catalytic walls have a light matte colour and a porous surface. Catalytic walls of the oven should not be cleaned. Porous surfaces of the catalytic walls are automatically cleaned by absorbing and converting the spilled oil (steam and carbon dioxide).

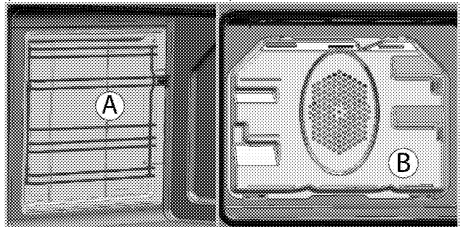

## Easy Steam Cleaning

It ensures easy cleaning because the dirt (having waited not for too long) is softened with the steam that forms inside the oven and the water drops condensing on the inner surfaces of the oven.

1. Remove all accessories inside the oven.
2. Pour 500 ml of water into the oven tray and place the tray at the 2nd rack of the oven.

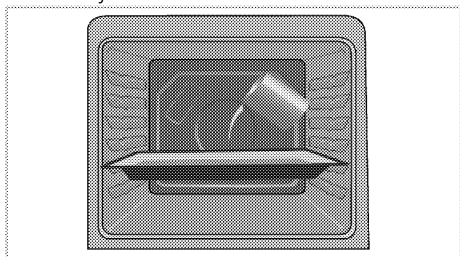

3. Set the oven to easy steam cleaning mode and run at 100°C for 25 minutes.
4. Open the door and wipe the inner surfaces of the oven with a damp sponge or cloth.
5. Use warm water with washing liquid, a soft cloth or sponge to clean the persistent dirt and wipe it with a dry cloth.

## Clean oven door

To clean the oven door, use warm water with washing liquid, a soft cloth or sponge to clean the product and wipe it with a dry cloth.



Don't use any harsh abrasive cleaners or sharp metal scrapers for cleaning the oven door. They could scratch the surface and destroy the glass.

## Removing the top oven door

1. Open the front door (1).
2. Open the clips at the hinge housing (2) on the right and left hand sides of the front door by pressing them down as illustrated in the figure.

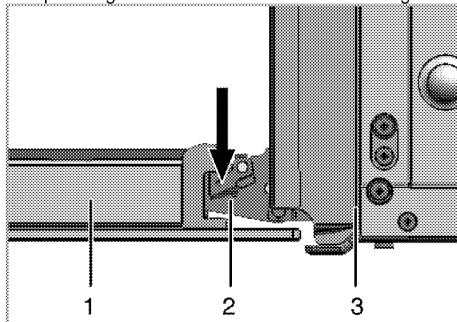

- 1 Front door
- 2 Hinge
- 3 Oven

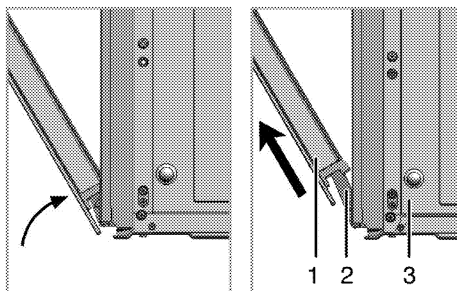

3. Move the front door to half-way.
4. Remove the front door by pulling it upwards to release it from the right and left hinges.



Steps carried out during removing process should be performed in reverse order to install the door. Do not forget to close the clips at the hinge housing when reinstalling the door.



## Removing the door inner glass

(This feature is optional. It may not exist on your product.)

The entire inner glass panel of the oven door can be removed for cleaning.

Open the oven door.

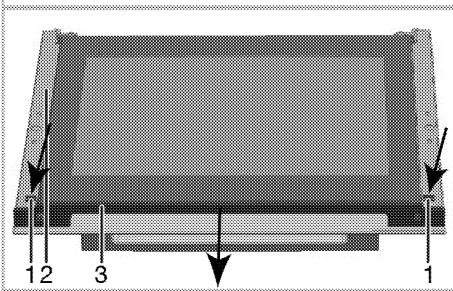
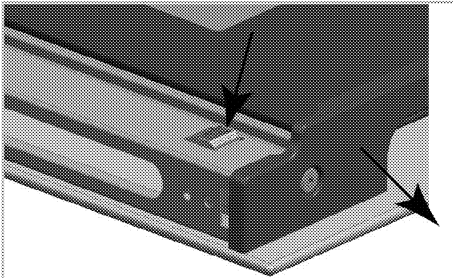

- 1 Tab
- 2 Frame
- 3 Profile

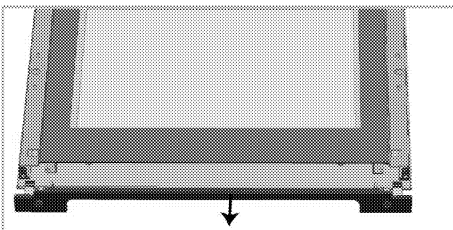

As illustrated in the figures above, press on the tabs (1) and pull the profile (3) towards yourself simultaneously to remove the profile attached to the upper side of the front door.

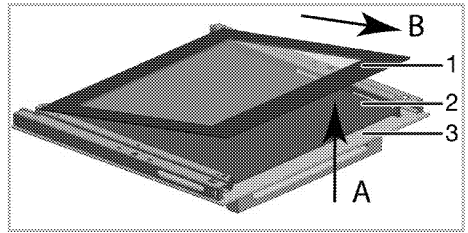

- 1 Innermost glass panel
- 2 Inner glass panel\*
- 3 Outer glass panel

\* (It may not exist on your product.)

As illustrated in the figure, raise the innermost glass panel (1) slightly in direction 'A' and pull it out in direction 'B'.

If your product is equipped with an inner glass panel; Pull the glass holder connecting elements in the middle as illustrated in the figure to free them from the glass panels.

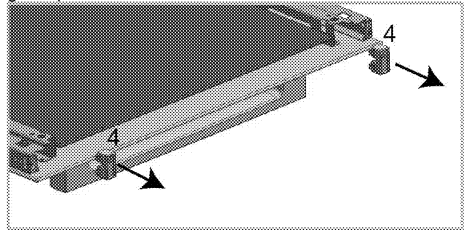

- 4 Glass holder connecting element\*

\* (It may not exist on your product.)

Repeat the same procedure to remove the inner glass panel (2). The first step to regroup the door is reinstalling inner glass panel (2).

As illustrated in the figure, place the glass panel so that it is inserted to the plastic slot.

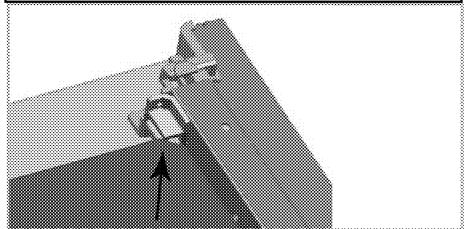

When installing the innermost glass panel (1), make sure that the printed side of the panel faces towards the inner glass panel.

It is important that the lower corners of the innermost glass panel are seated into the plastic slots.

**i** Otherwise the glass panel will not seat completely and may get exposed to vibration and break.

Please remember to place the glass holding connecting parts into their slots.

Finally, press on the tabs of the profile to make them seat into their slots again.

### Replacing the oven lamp

**!** **DANGER:**  
Before replacing the oven lamp, make sure that the product is disconnected from mains and cooled down in order to avoid the risk of an electrical shock.  
Hot surfaces may cause burns!

**i** The oven lamp is a special electric light bulb that can resist up to 300 °C. See *Technical specifications, page 12* for details. Oven lamps can be obtained from Authorised Service Agents or technician with licence.

**i** Position of lamp might vary from the figure.

**i** The lamp used in this appliance is not suitable for household room illumination. The intended purpose of this lamp is to assist the user to see foodstuffs.

**i** The lamps used in this appliance have to withstand extreme physical conditions such as temperatures above 50 °C.

#### If your oven is equipped with a round lamp:

1. Disconnect the product from mains.
2. Turn the glass cover counter clockwise to remove it.

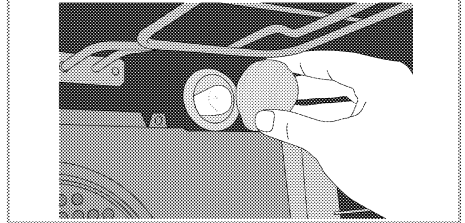

3. If your oven lamp is of type (A) shown in the figure below, remove it by rotating as shown and replace it. If it is of type (B), pull and remove it as shown in the figure and replace it.

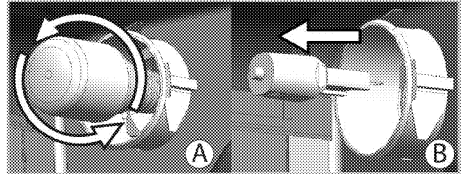

4. Install the glass cover.

## 8 Troubleshooting

### **Oven emits steam when it is in use.**

- It is normal that steam escapes during operation. >>> *This is not a fault.*

### **Product emits metal noises while heating and cooling.**

- When the metal parts are heated, they may expand and cause noise. >>> *This is not a fault.*

### **Product does not operate.**

- The mains fuse is defective or has tripped. >>> *Check fuses in the fuse box. If necessary, replace or reset them.*
- Product is not plugged into the (grounded) socket. >>> *Check the plug connection.*

### **Oven light does not work.**

- Oven lamp is defective. >>> *Replace oven lamp.*
- Power is cut. >>> *Check if there is power. Check the fuses in the fuse box. If necessary, replace or reset the fuses.*

### **Oven does not heat.**

- Function and/or Temperature are not set. >>> *Set the function and the temperature with the Function and/or Temperature knob/key.*
- Power is cut. >>> *Check if there is power. Check the fuses in the fuse box. If necessary, replace or reset the fuses.*



Consult the Authorised Service Agent or technician with licence or the dealer where you have purchased the product if you can not remedy the trouble although you have implemented the instructions in this section. Never attempt to repair a defective product yourself.

## 9 Guarantee Details

Your new Beko product is guaranteed against faulty materials, defective components or manufacturing defects. The guarantee starts from the date of original purchase of the product for a period of twelve (12) months unless Beko plc (the "Manufacturer") agrees to extend the guarantee for the product in writing. If you have any questions about the guarantee on your product (including how long it is valid), please contact your retailer or our Call Centre on 0333 207 9710.

This guarantee does not in any way diminish or affect your statutory rights in connection with the product. This guarantee is in addition to your statutory rights as a consumer. If you have any questions about these rights, please contact the retailer from which you purchased the product. In certain circumstances, it is possible that your statutory rights may offer additional or higher levels of protection than those offered under the terms of this guarantee.

### What is covered by this guarantee?

- Repairs to the product required as a result of faulty materials, defective components or manufacturing defects.
- Functional replacement parts to repair a product.
- The costs of a Beko Approved Engineer to carry out the repair.

### What is not covered?

- Transit and delivery damage.
- Cabinet or appearance parts, including but not limited to control knobs, flaps and handles.
- Accessories and/or consumable items including but not limited to ice trays, scrapers, cutlery baskets, filters and light bulbs.
- Repairs necessary as a direct or indirect result of:
  - Accidental damage, misuse or abuse of a product.
  - An attempted repair of a product by anyone other than a Beko authorised repairer.
  - Installation or use of a product where such installation or use fails to meet the requirements contained in this guarantee or the User Instructions Booklet.
- Repairs to a product operated at any time on commercial or non-residential household premises (unless we have previously agreed to the installation environment).

This guarantee is limited to the cost of repairing the product. To the extent permitted by law, the Manufacturer does not accept and will not be held liable for any financial loss incurred in connection with the failure of any product to operate in accordance with the expected standards. Such financial loss includes but is not limited to loss arising from:

- Time taken off work.
- Damaged food, clothing or other items.
- Meals taken at restaurants or from takeaways.
- General compensation for inconvenience.

### Important Notes

- Your product is designed and built for domestic household use only.
- The guarantee will automatically be void if the product is installed or is used in commercial or non-residential domestic household premises, unless we have previously agreed to the installation environment.
- The product must be correctly installed, located and operated in accordance with the instructions contained in the User Instructions Booklet provided with your product.
- Professional installation by a qualified Electrical Domestic Appliance Installer is recommended for all Washing Machines, Dishwashers and Electric Cookers (as incorrect installation may result in you having to pay for the cost of repairing the product).
- Gas Cookers must be professionally installed by a Gas Safe (or Gas Networks Ireland for Republic of Ireland) registered gas installer.

- This guarantee is given in respect of products purchased and used within the United Kingdom and the Republic of Ireland.
- This guarantee is effective from the initial date of purchase of a new product from an authorised retailer and will be void if the product is resold.
- This guarantee does not apply to graded sales (where the product is purchased as a “second”).
- Possession of a copy of these terms and conditions does not necessarily mean that a product has the benefit of this guarantee. If you have any questions, please call our Call Centre on the number set out above.
- The Manufacturer reserves the right to terminate the guarantee if its staff or representatives are subjected to physical or verbal abuse in the course of carrying out their duties.
- Optional extras, where available (i.e. extendable feet) are supplied on a chargeable basis only.

### **Does Beko offer replacements?**

This is a repair-only guarantee. On occasion, the Manufacturer may at its sole discretion, replace your product with a new product instead of carrying out a repair. Where a replacement is offered, this would normally be an identical model but when this is not possible, a model of similar specification will be provided. The Manufacturer will cover the costs and arrange for the delivery of the new product and for the return of the old product. Any costs related to disconnecting the faulty product and installing the replacement product will not be borne by the Manufacturer unless previously agreed to in writing. The original guarantee will continue to apply to the replacement product; the new product will not come with a new guarantee.

### **When will the repair take place?**

Our Engineers work Monday to Friday 9.00am to 5.00pm. Appointments outside these hours may be possible at the sole discretion of the Manufacturer but cannot be guaranteed. Whilst our Engineers will endeavour to minimize inconvenience and to meet requests for specific timed appointments, this cannot be guaranteed. We will not be liable for delays or if it is unable to carry out a repair because a convenient appointment cannot be arranged.

### **Will there be any charge for the repairs?**

It is your responsibility to provide evidence to the Engineer that your product is covered by this guarantee with a proof of purchase. The Manufacturer reserves the right to charge for the reasonable cost of any service call if:

- You cannot provide evidence that your product is covered by this guarantee.
- Where a service call has been made and the engineer finds that there is no fault with your product.
- That your product has not been installed or operated in accordance with the User Instructions Booklet.
- That the fault was caused by something other than faulty materials, defective components or manufacturing defects.
- For missed appointments.

Payment of these costs are due immediately upon the Engineer providing you with an invoice. The Manufacturer reserves the right to terminate the guarantee if you fail to pay the costs for the service call in a timely manner.

If you are a resident of the United Kingdom, this guarantee will be governed by English law and subject to the English Courts, save where you live in another part of the United Kingdom, in which case the law and courts of that location will apply.

If you are resident in the Republic of Ireland, this guarantee will be governed by Irish law and the Irish courts will have jurisdiction.

## HOW TO OBTAIN SERVICE

Please keep your purchase receipt or other proof of purchase in a safe place; you will need to have it should the product require attention under guarantee.

It will be useful if you complete the details below, as it will help us assist you when requesting service (the model number is printed on the Instruction Booklet and the serial number is printed on the Rating Label affixed to the appliance). Recording of these details alone will not count as proof of purchase. A valid proof of purchase is required for under guarantee service.

The area around the product must be easily accessible to the Engineer without the need for cabinets or furniture being removed.

It is your responsibility to ensure our Engineers have a clean and safe environment to carry out any repairs.

.....  
Model No:

Serial No:

Retailer:

Date of purchase:  
.....

**For service under guarantee simply telephone the appropriate number below:**

**UK Mainland & Northern Ireland:** 0333 207 9710 or [customerservice@support.Beko.co.uk](mailto:customerservice@support.Beko.co.uk)

**Republic of Ireland:** 01 862 3411 or [customerservice@support.Beko.ie](mailto:customerservice@support.Beko.ie)

**Register your appliance:** For UK registrations visit [beko.co.uk/register](http://beko.co.uk/register) and for the Republic of Ireland [beko.ie/register](http://beko.ie/register).

Before requesting service please check the troubleshooting guide in the Operating Instructions as a charge may be levied where no fault is found even though your product may still be under guarantee.

**Service once the manufacturers guarantee has expired**

If you have purchased an extended guarantee please refer to the instructions contained within the extended guarantee agreement document, otherwise please call the appropriate number above where service can be obtained at a charge.

Should you experience any difficulty in obtaining service contact the Beko Customer Helpline on Tel: 0333 207 9710 or e-mail: [CustomerService@support.beko.co.uk](mailto:CustomerService@support.beko.co.uk)  
.....

This guarantee is provided by Beko plc. Beko House, 1 Greenhill Crescent, Watford, Herts, WD18 8QU. Beko plc is registered in England and Wales with company registration number 02415578.







## Free Manuals Download Website

<http://myh66.com>

<http://usermanuals.us>

<http://www.somanuals.com>

<http://www.4manuals.cc>

<http://www.manual-lib.com>

<http://www.404manual.com>

<http://www.luxmanual.com>

<http://aubethermostatmanual.com>

Golf course search by state

<http://golfingnear.com>

Email search by domain

<http://emailbydomain.com>

Auto manuals search

<http://auto.somanuals.com>

TV manuals search

<http://tv.somanuals.com>