

Microwave Oven

User Manual



MOF20110X

EN

01M-8854283200-1117-04

beko

Please read this manual first!



Dear Customer,

Thank you for selecting a Beko product. We hope that you get the best results from your product which has been manufactured with high quality and state-of-the-art technology. Therefore, please read this entire user manual and all other accompanying documents carefully before using the product and keep it as a reference for future use. If you handover the product to someone else, give the user manual as well. Follow all warnings and information in the user manual.

Remember that this user manual is also applicable for several other models. Differences between the models are explicitly described in the manual.

Meanings of the symbols

Following symbols are used in the various section of this user manual:

	Important information and useful hints about usage.
	Warnings for dangerous situations concerning the safety of life and property.
	Warning for hot surfaces.



This product has been manufactured in environmentally modern facilities.

CONTENTS

1 Important safety and environmental instructions 4

1.1 General safety.....	4
1.2 Intended use.....	8
1.3 Children's safety.....	9
1.4 Compliance with the WEEE Directive and Disposing of the Waste Product:	10
1.5 Compliance with RoHS Directive.....	10
1.6 Package information.....	10
1.7 Plug Wiring.....	10

2 Your microwave oven 11

2.1 Overview.....	11
2.2 Technical data	11
2.3 Installing the turntable	12

3 Installation and connection 13

3.1 Installation and connection	13
---------------------------------------	----

4 Operation 14

4.1 Control panel.....	14
4.2 Operating instructions	14
4.2.1 Setting the time.....	14
4.2.2 Kitchen timer (counter).....	14
4.2.3 Cooking with microwave oven.....	15
4.3 Speedy Cooking.....	16
4.4 Defrost by weight	16
4.5 Defrost by time.....	16
4.6 Auto menu.....	16
4.6.1 Auto cooking menu	17
4.7 Multi-Stage cooking	18
4.8 Inquiring Function.....	18
4.9 Child lock	18
4.10 Specification	18

5 Cleaning and maintenance 19

5.1 Cleaning.....	19
5.2 Storage.....	19

6 Troubleshooting 20

7 Guarantee and Service 21

1 Important safety and environmental instructions

Important Safety Instructions Read Carefully And Keep For Future Reference

This section contains safety instructions that will help protect from risk of fire, electric shock, exposure to leak microwave energy, personal injury or property damage. Failure to follow these instructions shall void any warranty.

1.1 General safety

- The microwave oven is intended for heating food and beverages. Drying of food or clothing and heating of warming pads, slippers, sponges, damp cloth and similar may lead to risk of injury, ignition or fire.

This appliance is intended to be used in household and similar applications such as:

- Staff kitchen areas in shops, offices and other working environments;
- Farm houses
- By clients in hotels, and other residential type environments;
- Bed and Breakfast type environments.

- Do not attempt to start the oven when its door is open; otherwise you may be exposed to harmful microwave energy. Safety locks should not be disabled or tampered with.
- Do not place any object between the front side and the door of the oven. Do not allow dirt or cleaning agent remnants to build up on the closure surfaces.
- Any service works involving removal of the cover that provides protection against exposure to microwave energy must be performed by authorized persons/service. Any other approach is dangerous.
- Your product is intended for cooking, heating and defrost food at home. It must not be used for commercial purposes. Manufacturer shall not be held liable for damages that have arisen from misuse.
- Do not use this appliance outdoors, bathrooms, humid environments or in places where the it can get wet.
- No responsibility or warranty claim shall be assumed for damages arising from misuse or improper handling of the appliance.

1 Important safety and environmental instructions

- Never attempt to dismantle the appliance. No warranty claims are accepted for damage caused by improper handling.
- Only use the original parts or parts recommended by the manufacturer.
- Do not leave this appliance unattended while it is in use.
- Always use the appliance on a stable, flat, clean dry, and non-slip surface.
- The appliance should not be operated with an external clock timer or separate remote control system.
- Before using the appliance for the first time, clean all parts. Please see the details given in the "Cleaning and Maintenance" section.
- Operate the appliance for its intended purpose only as described in this manual. Do not use abrasive chemicals or steam on this appliance. This oven is particularly intended for heating and cooking the food.
It is not intended for industrial or laboratory use.
- Do not use your appliance to dry clothes or kitchen towels.
- Appliance becomes very hot while it is in use. Pay attention not to touch the hot parts inside the oven.
- Your oven is not designed to dry any living being.
- Do not operate the oven empty.
- Only use utensils that are suitable for use in microwave ovens.
- Cooking utensil may get hot due to the heat transferred from the heated food to the utensil. You may need oven gloves to hold the utensil.
- Utensils shall be checked to ensure that they are suitable for use in microwave ovens.
- Do not place the oven on stoves or other heat generating appliances. Otherwise, it may be damaged and the warranty becomes void.
- Microwave oven must not be placed in a cabinet that is not in compliance with the installation instructions.
- Steam may come out while opening the covers or the foil after cooking the food.
- Use gloves while taking any kind of heated food out.

1 Important safety and environmental instructions

- The appliance and its accessible surfaces may be very hot when the appliance is in use.
- Door and outer glass may be very hot when the appliance is in use.
- Use the appliance with a grounded outlet only.
- Never use the appliance if the power cable or the appliance itself is damaged.

1.1.1 Electrical safety

- If the supply cord is damaged, it must be replaced by the manufacturer or its service agent or a similarly qualified person in order to avoid a hazard.
- Beko Microwave Ovens comply with the applicable safety standards; therefore, in case of any damage on the appliance or power cable, it should be repaired or replaced by the dealer, service center or a specialist and authorized service alike to avoid any danger. Faulty or unqualified repair work may be dangerous and cause risk to the user.
- Make sure that your mains power supply complies with the information supplied on the rating plate of the appliance.

The only way to disconnect the appliance from the power supply is to remove the power plug from the power outlet.
- Do not use this appliance with an extension cord.
- Never touch the appliance or its plug with damp or wet hands.
- Place the appliance in a way so that the plug is always accessible.
- Prevent damage to the power cable by not squeezing, bending, or rubbing it on sharp edges. Keep the power cable away from hot surfaces and naked flame.
- Make sure that there is no danger that the power cable could be accidentally pulled or that someone could trip over it when the appliance is in use.
- Unplug the appliance before each cleaning and when the appliance is not in use.
- Do not pull the power cable of the appliance to disconnect it from its power supply and never wrap its power cable around the appliance.
- Do not immerse the appliance, power cable, or power plug in water or any other liquids. Do not hold it under running water.

1 Important safety and environmental instructions

- When heating food in plastic or paper containers, keep an eye on the oven due to the possibility of ignition. Ensure containers are suitable for microwave use.
- Remove the wire strings and/or metal handles of paper or plastic bags before placing bags suitable for use in microwave oven to the oven.
- If smoke is observed, switch off or unplug the appliance if safe to do so and keep the door closed in order to stifle any flames.
- Do not use microwave oven for storage. Do not leave paper items, cooking material or food inside the oven when it is not being used.
- The contents of feeding bottles and baby food jars should be stirred or shaken and the temperature be checked before consumption, in order to avoid burns.
- This appliance is a Group 2 Class B ISM equipment. Group 2 contains all ISM (Industrial, Scientific and Medical) equipment in which radio-frequency energy is intentionally generated and/or used in the form of electromagnetic radiation for the treatment of material, and spark erosion equipment.
- Class B equipment is suitable for use in domestic establishments and establishments directly connected to a low voltage power supply network.
- Door or outer surface of the appliance may become hot when it is in use.

1.1.2 Product safety

- Be careful when removing beverages and food from the microwave.
- Do not use cooking oil in the oven. Hot oil may damage the components and materials of the oven, and it may even cause skin burns.
- Pierce food with thick crust such as potatoes, courgettes, apples and chestnuts.
- Appliance must be placed so that the rear side is facing the wall.
- Before moving the appliance, please secure the turntable to prevent damage.

1

Important safety and environmental instructions

- Eggs in their shell and whole hard-boiled eggs must not be heated in microwave ovens since they may explode, even after microwave heating has ended.
- Never remove the parts at the rear and sides of the appliance, which protect the minimum distances between the cabinet walls and the appliance in order to allow for the required air circulation.
- **WARNING:** It is hazardous for anyone other than a competent person to carry out any service or repair operation which involves the removal of a cover which gives protection against exposure to microwave energy.
- **WARNING:** Liquids and other foods must not be heated in sealed containers since they are liable to explode.

1.2 Intended use

- Failure to maintain the oven in a clean condition could lead to deterioration of the surface that could adversely affect the life of the appliance and possibly result in a hazardous situation.
- Cleaning the door seals and adjacent parts: Use hot soapy water. Clean with a dish cloth, do not scour. Do not use a metal or glass scraper for cleaning.
- **WARNING:** If the door or door seals are damaged, the oven must not be operated until it has been repaired by a competent person.
- The oven should be cleaned regularly and any food deposits removed.
- There should be min 30 cm free space above the top surface of the oven.
- Do not use the appliance for anything other than its intended use.
- Do not use the appliance as a heat source.
- Microwave oven is intended to thaw, cook and stew food only.
- Do not over-cook foods; otherwise, you may cause a fire.
- Do not use steam assisted cleaners to clean the appliance.

1 Important safety and environmental instructions

1.3 Children's safety

- Extreme caution is advised when being used near children and persons who are restricted in their physical, sensory or mental abilities.
- This appliance can be used by the children who are at the age of 8 or over and by the people who have limited physical, sensory or mental capacity or who do not have knowledge and experience, as long as they are supervised with regard to safe use of the product or they are instructed accordingly or understand the risks of using the product. Children should not play with the appliance. Cleaning and user maintenance procedures should not be performed by children unless they are controlled by their elders.
- Danger of choking! Keep all the packaging materials away from children.
- Only allow children to use the oven without supervision when adequate instructions have been given so that the child is able to use the microwave oven in a safe way and understands the hazards of improper use.
- Due to excessive heat that arises in grill and combination modes, children should only be allowed to use these modes under supervision of an adult.
- Keep the product and its power cable so that they are inaccessible by children under 8 years old.
- The appliance and its accessible surfaces may be very hot when the appliance is in use. Keep children away.
- The appliance is not intended for use by persons (including children) with reduced physical, sensory or mental capabilities, or lack of experience and knowledge, unless they have been given supervised or instruction concerning use of the appliance by a responsible person for their safety.
- Young children should be supervised to ensure that they do not play with the appliance.
- **WARNING:** Only allow children to use the oven without supervision when adequate instructions have been given so that the child is able to use the oven in a safe way and understands the hazards of improper use.

1

Important safety and environmental instructions

1.4 Compliance with the WEEE Directive and Disposing of the Waste Product:

This product complies with EU WEEE Directive (2012/19/EU). This product bears a classification symbol for waste electrical and electronic equipment (WEEE).



This product has been manufactured with high quality parts and materials which can be reused and are suitable for recycling. Do not dispose of the waste product with normal domestic and other wastes at the end of its service life. Take it to the collection center for the recycling of electrical and electronic equipment. Please consult your local authorities to learn about these collection centers.

1.5 Compliance with RoHS Directive

The product you have purchased complies with EU RoHS Directive (2011/65/EU). It does not contain harmful and prohibited materials specified in the Directive.

1.6 Package information



Packaging materials of the product are manufactured from recyclable materials in accordance with our National Environment Regulations. Do not dispose of the packaging materials together with the domestic or other wastes. Take them to the packaging material collection points designated by the local authorities.

1.7 Plug Wiring

The moulded plug on this appliance incorporates a 13 A fuse. Should the fuse need to be replaced an ASTA approved BS1362 fuse of the same rating must be used. Do not forget to refit the fuse cover. In the event of losing the fuse cover, the plug must not be used until a replacement fuse cover has been fitted. Colour of the replacement fuse cover must be the same colour as that visible on the pin face of the plug. Fuse covers are available from any good electrical store.

• Fiting a different plug

As the colours of the wires in the mains lead of this appliance may not correspond with the coloured markings identifying the terminals on your plug, proceed as follows:

- Brown cable = L (Live)
- Blue cable = N (Neutral)
- Green/yellow cable must be connected to ground (E) \equiv line

With the alternative plugs a 13 A fuse must be fitted either in the plug or adaptor or in the main fuse box. If in doubt contact a qualified electrician.

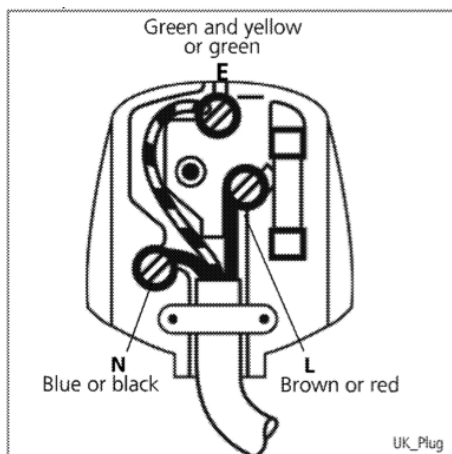

2 Your microwave oven

2.1 Overview

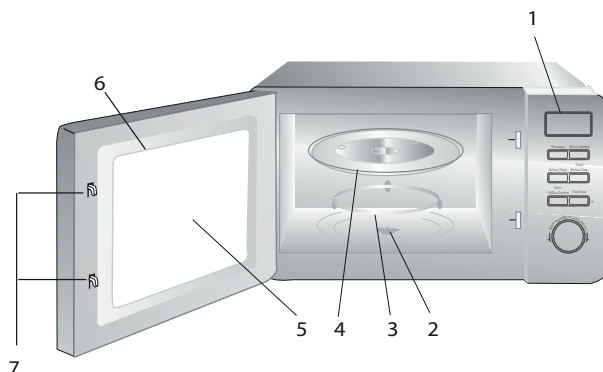

1. Control panel
2. Turntable shaft
3. Turntable support
4. Glass tray
5. Oven window
6. Door group
7. Door safety interlock system

2.2 Technical data

Power consumption	230 V~50 Hz, 1250 W (Microwave)
Output	800 W
Operating frequency	2450 MHz
Ampere value	13A
External dimensions (Microwave Oven)	(H) 258.2 mm / (l) 439.5 mm / (P) 356 mm
Internal dimensions of the oven	(H) 205.2 mm / (l) 303.6 mm / (P) 306 mm
Oven Capacity	20 Liters
Net weight	11.1 kg
Net weight (Kit contents)	12.1 kg

Markings on the product or the values stated in other documents supplied with the product are values obtained under laboratory conditions as per relevant standards. These values may vary according to the usage of the appliance and ambient conditions. Power values are tested at 230V.

2 Your microwave oven

2.3 Installing the turntable

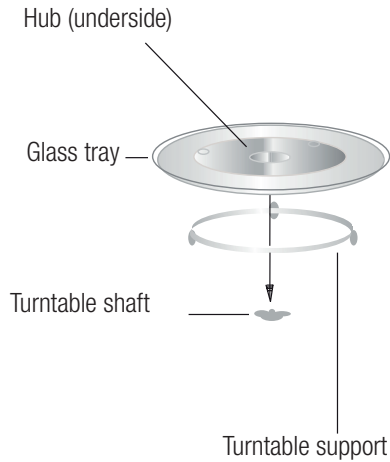

- Never place the glass tray upside down. The glass tray should never be restricted.
- Both glass tray and turntable support must always be used during cooking.
- All food and containers of food must always place on the glass tray for cooking.
- If glass tray or turntable support crack or break, contact your nearest authorized service center.

3 Installation and connection

3.1 Installation and connection

- Remove all packing material and accessories. Examine the oven for any damage such as dents or broken door. Do not install if oven is damaged.
- Remove any protective film found on the microwave oven cabinet surface.
- Do not remove the light brown Mica cover that is attached to the oven cavity to protect the magnetron.
- Select a flat surface that provides sufficient space for inlet and outlet ducts.

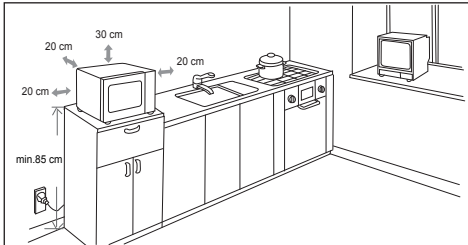

- Minimum installation height is 85 cm.
 - The rear surface of appliance shall be placed against a wall. Leave a minimum clearance of 30cm above the oven, a minimum clearance of 20cm is required between the oven and any adjacent walls.
 - Do not remove the legs from the bottom of the oven.
 - Blocking the intake and / or outlet openings can damage the oven.
 - Place the oven as far away from radios and TV as possible. Operation of microwave oven may cause interference to your radio or TV reception.
2. Plug your oven into a standard household outlet. Be sure the voltage and the frequency is the same as the voltage and the frequency on the rating label.



The accessible surface may be hot during operation.



WARNING: Do not install oven over a range cooktop or other heat-producing appliance. If installed near or over a heat source, the oven could be damaged and the warranty would be void.

4 Operation

4.1 Control panel

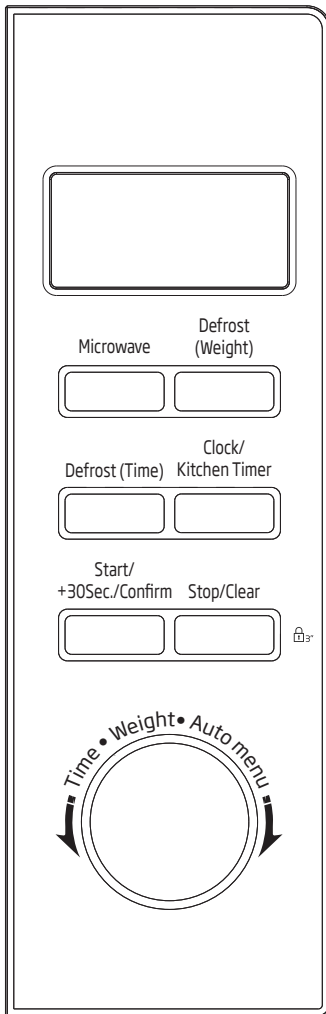



4.2 Operating instructions

This microwave oven uses modern electronic control to adjust cooking parameters to meet your needs better for cooking.

4.2.1 Setting the time

When the microwave oven is turned on, "0:00" will be displayed in LED screen and buzzer will ring once.

1. Press "Clock/Kitchen Timer" key once and the figures for clock will start flashing.
2. Turn  to adjust the hour; the input value should be between 0 and 23.
3. Press "Clock/Kitchen Timer" key and the figures for minutes will start flashing.
4. Turn  to adjust the minutes; the input value should be between 0 and 59.
5. Press "Clock/Kitchen Timer" key to complete the time setting. ":" symbol will flash and time will appear.



If the clock is not set, it would not function when powered.



If you press "Stop/Clear" during time setting, oven will automatically return back to previous mode.

4.2.2 Kitchen timer (counter)

Your oven is equipped with an automatic counter which is not linked with the oven functions and can be used separately in the kitchen (it can be set to max. 95 minutes.)

1. Press "Clock/Kitchen Timer" key twice and 00:00 will be displayed in LED screen.
2. Turn  to enter the correct time.
3. Press "Start/+30Sec./Confirm" to confirm the setting.

4 Operation

4. When the kitchen time is reached, clock indicator will go out. The buzzer will ring 5 times.

If the clock has been set (24-hour system), screen will display the current time.

Press "Stop/Clear" to abort the timer at anytime.



Kitchen timer functions different than 24-clock system. Kitchen timer is just a timer.

4.2.3 Cooking with microwave oven

1. Press "Microwave" and "P100" will be displayed in LED screen.

2. Press "Microwave" or turn  to select the microwave power "P100", "P80", "P50", "P30", "P10" will display in order.

3. Press "Start/+30Sec./Confirm" to confirm and turn  to set the cooking time to a value between 0:05 and 95:00.

4. Press "Start/+30Sec./Confirm" again to start cooking.



Example: If you want to use 80% microwave power to cook for 20 minutes, you can operate the oven with the following steps.

5. Press "Microwave" once and "P100" will be displayed in the screen.

6. Press "Microwave" once again or turn  to set 80% microwave power.

7. Press "Start/+30Sec./Confirm" to confirm and "P 80" will be displayed in the screen.

8. Turn  to adjust the cooking time until the oven displays "20:00".

9. Press "Start/+30Sec./Confirm" to start cooking. The steps for adjusting the time in coding button are as below:

Setting the duration	Increment amount
0-1 minute	5 seconds
1-5 minutes	10 seconds
5-10 minutes	30 seconds
10-30 minutes	1 minute
30-95 minutes	5 minutes

4 Operation

Microwave Power Chart

Press	Once	Twice	3 times	4 times	5 times
Microwave Power	100%	80%	50%	30%	10%

4.3 Speedy Cooking

1. In waiting state (no functions selected), press "Start/+30Sec./Confirm" key to cook with 100% power level for 30 seconds. Each press on the same key can increase 30 seconds. The maximum cooking time is 95 minutes.
2. During the microwave cooking and time defrost process, press "Start/+30Sec./Confirm" to increase the cooking time.
3. In waiting state (no functions selected), turn  left to choose the cooking time directly. After choosing the time, press "Start/+30Sec./Confirm" to start cooking. The microwave power is 100%.



Under the states of auto menu and weight defrost, cooking time cannot be increased by pressing "Start/+30Sec./Confirm"

4.4 Defrost by weight



1. Press "Defrost Weight" once, the screen will display "dEF1".
2. Turn  to select the weight of food from 100 to 2000 g.
3. Press "Start/+30Sec./Confirm" to start defrost.

4.5 Defrost by time

1. Press "Defrost Time" once, the screen will display "dEF2".



2. Turn  to select the defrost time. The maximum time is 95 minutes.
3. Press "Start/+30Sec./Confirm" to start defrost. Defrost power is P30 and cannot be changed.

4.6 Auto menu

1. Turn  clockwise to select the desired menu. Menus between "A-1" and "A-8", will be displayed, namely pizza, meat, vegetable, pasta, potato, fish, beverage and popcorn, (refer to chart on following page).
2. Press "Start/+30Sec./Confirm" to confirm.
3. Turn  to choose the default weight in accordance with the menu chart.
4. Press "Start/+30Sec./Confirm" to start cooking.



Example: If you want to use "Auto Menu" to cook 350 g fish:

1. Turn  clockwise until "A-3" is displayed in the screen.
2. Press "Start/+30Sec./Confirm" to confirm.
3. Turn  to select the weight of fish until "350" is displayed in the screen.
4. Press "Start/+30Sec./Confirm" to start cooking.

4 Operation

4.6.1 Auto cooking menu

Menu	Weight	Display
A-1 Auto reheat	200 g	200
	400 g	400
	600 g	600
A-2 Vegetable	200 g	200
	300 g	300
	400 g	400
A-3 Fish	250 g	250
	350 g	350
	450 g	450
A-4 Meat	250 g	250
	350 g	350
	450 g	450
A-5 Pasta	50 g (with 450 ml cold water)	50
	100 g (with 800 ml cold water)	100
A-6 Potato	200 g	200
	400 g	400
	600 g	600
A-7 Pizza	200 g	200
	400 g	400
A-8 Soup	200 ml	200
	400 ml	400

4 Operation



4.7 Multi-Stage cooking

A maximum of two stages can be set. If one stage is defrosting, it should be put in the first stage automatically. The buzzer will ring once after each stage and the next stage will begin.

Auto menu cannot be set as one of the multi-stage.



if you want to defrost the food for 5 minutes, then to cook with 80% microwave power for 7 minutes. The steps are as following:

1. Press "Defrost Time" once, the screen will display "dEF2".
2. Turn  to adjust the defrost time of 5 minutes;
3. Press "Microwave" once;
4. Turn  to choose 80% microwave power till "P80" display;
5. Press "Start/+30Sec./Confirm" to confirm;
6. Turn  to adjust the cooking time of 7 minutes;
7. Press "Start/+30Sec./Confirm" to start cooking.

4.8 Inquiring Function

1. In cooking mode press "Microwave", the current power will be for 3 seconds.
2. During cooking mode, press "Clock/Kitchen Timer" to check the current time. It will be displayed for 3 seconds.

4.9 Child lock

1. **Locking:** In waiting state (no functions selected), press "Stop/Clear" for 3 seconds, there will be a long "beep" denoting entering the children-lock state.
2. **Unlocking:** In locked state, press "Stop/Clear" for 3 seconds, there will be a long "beep" denoting that the lock is released.

4.10 Specification

1. The buzzer will sound once when turning the knob at the beginning;
2. "Start/+30Sec./Confirm" must be pressed to continue cooking if the door is opened during cooking;
3. Once the cooking programme has been set, and the "Start/+30Sec./Confirm" is not pressed within 1 minute. The current time will be displayed. The setting will be cancelled.
4. The buzzer sounds once by efficient press, inefficient press will have no response.
5. The buzzer will sound five times to remind you when cooking is finished.

5 Cleaning and maintenance

5.1 Cleaning



WARNING: Never use gasoline, solvent, abrasive cleaning agents, metal objects or hard brushes to clean the appliance.



WARNING: Never immerse the appliance or its power cable in water or in any other liquid.

1. Turn the appliance off and disconnect it from wall socket.
2. Wait for the appliance to completely cool down.
3. Keep the inside of the oven clean. Wipe with a damp cloth when splashed food or spilled liquids stick on the walls of the oven. A mild detergent may be used if the oven gets very dirty. Avoid using sprays and other harsh cleaning agents as they may cause stains, marks, and opaqueness on the door surface.
4. Outer surfaces of the oven must be cleaned with a damp cloth. Do not allow water ingress from ventilation openings to prevent damage to the operating parts in the oven.
5. Wipe both sides of the door and the glass, door gaskets and parts near the gaskets frequently with a damp cloth in order to remove the overflowing and splashing stains. Do not use abrasive cleaning agents.
6. Do not allow control panel to get wet. Clean with a soft damp cloth. Leave the door of the oven open to prevent inadvertent operation while cleaning the control panel.
7. If steam accumulates inside or around the oven door, wipe with a soft cloth. This may occur when the microwave oven is operated under high humidity conditions. It is normal.
8. In some cases, you may need to remove the glass tray for cleaning. Wash the tray in warm soapy water or in a dishwasher.
9. The roller ring and oven floor should be cleaned regularly to avoid excessive noise. It would be sufficient to wipe the lower surface of the oven with a mild detergent. Roller ring may be washed in warm soapy water or in a dishwasher. When you remove the roller ring from oven internal floor for cleaning, ensure that you install it in the correct position while replacing it.
10. In order to remove bad odors in your oven, put a glass of water and juice and peel of a lemon to a deep bowl suitable for use in microwave and operate the oven for 5 minutes in microwave mode. Wipe thoroughly and dry with a soft cloth.
11. Please contact the authorized service when the oven lamp needs to be replaced.
12. The oven should be cleaned regularly and any food deposits should be removed. If the oven is not kept clean, this may cause surface defects that would affect the lifecycle of the appliance negatively and that would possibly cause risks.
13. Please do not dispose this appliance with household waste; old ovens shall be disposed to special waste centers provided by the municipalities.
14. When the microwave oven is used in grill function, a small amount of smoke and odor may occur which will disappear after a certain time of usage.

5.2 Storage

- If you do not intend to use the appliance for a long time, please store it carefully.
- Please make sure that the appliance is unplugged, cooled down and totally dry.
- Store the appliance in a cool and dry place.
- Keep the appliance out of the reach of children.

6 Troubleshooting

Normal	
Microwave oven interferes with TV reception	Radio and TV reception may be interfered when microwave oven is operating. It is similar to the interference caused by small electrical appliances, like mixer, vacuum cleaner, and electric fan. It is normal.
Oven light is dimmed	In low power microwave cooking, oven light may be dimmed. It is normal.
Steam accumulating on door, hot air coming out of vents	During cooking, steam may arise from the food. Most of this steam will get out from vents. But some may accumulate on a cool place like oven door. It is normal.
Oven started accidentally with no food in it.	It is not allowed to run the appliance without any food inside. It is very dangerous.

Problem	Possible Reason	Solution
Oven cannot be started.	1) Power cable is not plugged in properly.	Unplug. Then plug again after 10 seconds.
	2) Fuse is blown or circuit breaker is activated.	Replace fuse or reset circuit breaker (repaired by professional personnel of our company).
	3) Trouble with outlet.	Test the outlet with other electrical appliances.
Oven does not heat.	4) Door is not closed properly.	Close the door properly.
Glass turntable makes noise when microwave oven operates	5) Turntable and bottom of the oven is dirty.	Refer to "Cleaning and Maintenance" section to clean dirty parts.

7 Guarantee and Service

Product Guarantee

12 months breakdown and repair guarantee

Guarantor: **Beko plc, 1 Greenhill Crescent, Watford, Hertfordshire. WD18 8UF**

The guarantee does not in any way diminish your statutory or legal rights.

Your **microwave** has the benefit of our manufacturer's guarantee which covers the product for 12 months from the date of original purchase.

This gives you reassurance that if within that time, your **microwave** is proven to be defective because of either workmanship or materials, we will at our discretion either repair or replace your **microwave**.

The **microwave** must be correctly installed, located and operated in accordance with the instructions contained in the user manual. The guarantor disclaims any liability for accidental or consequential damage.

The Guarantee is subject to the following conditions:

- Documentary proof of the original purchase date is provided.
- The microwave has been installed and operated correctly and in accordance with our operating and maintenance instructions.
- The microwave is used only on the electricity supply on the rating plate.
- The microwave has only been used for normal domestic purposes.
- The microwave has not been altered, serviced, dismantled or otherwise interfered with by any person.
- The microwave is used in the United Kingdom or Republic of Ireland.
- Any parts removed during repair work or any product that has been replaced becomes our property.
- The guarantee is not transferrable if the product is resold.

The Guarantee does not cover:

- Transit, installation or delivery damage.
- Accidental damage.
- Misuse or abuse.
- Replacement of any consumable item or accessories. These include but are not limited to: plugs, cables, light bulbs, knobs, filters and flaps.
- Repairs or replacements required as a result of unauthorised repairs or inexpert installation that fails to meet the requirements contained in the user guide or instruction book.
- Repairs to products used in commercial or non-residential household premises.

How to obtain after sales service, help or general advice

Please keep your purchase receipt or other proof of purchase in a safe place as you will need to show us this document if your product requires attention within the guarantee period.

Please also record your product details below, which will allow you to access our services more quickly and help us identify your product. The model number is printed on the front of the user guide and the serial and model number is shown on your products rating plate.

Model number	Serial number	Purchased from	Date of purchase

Please call our UK based Customer Service department if you need help or advice from us:

United Kingdom and Northern Ireland: **0333 207 9710**
Republic of Ireland: **01 862 3411**
You can also contact us through our website: **www.beko.co.uk**



Free Manuals Download Website

<http://myh66.com>

<http://usermanuals.us>

<http://www.somanuals.com>

<http://www.4manuals.cc>

<http://www.manual-lib.com>

<http://www.404manual.com>

<http://www.luxmanual.com>

<http://aubethermostatmanual.com>

Golf course search by state

<http://golfingnear.com>

Email search by domain

<http://emailbydomain.com>

Auto manuals search

<http://auto.somanuals.com>

TV manuals search

<http://tv.somanuals.com>