

BEKO

installation & operating
instructions and washing guidance

Automatic
washing machine

WMA 520 S

WMA 520 W



get the best from your new washer

Dear customer

Congratulations on your choice of a Beko quality washing machine which has been designed to give you lasting service.

Please read these instructions thoroughly before installing or using - and keep for handy reference. Make sure you understand the controls prior to using your appliance. The washer must only be used for its intended purpose, ie the washing of clothes in the home. Failure to observe these instructions may invalidate your right to free service during the guarantee period.

If you have any questions, or if you are not sure about any information contained in this booklet please contact us - details are on the back cover.

Beko Customer Service

Notes

Due to the quality control processes applied to your machine during production, there may be some water left in your machine. This does not cause any damage.

Note that temperatures in this book are for guidance only. Always check the clothing labels before selecting your wash programme.

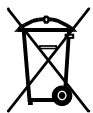

Recycling: This product bears the selective sorting symbol for waste electrical and electronic equipment (WEEE). This means that this product must be handled pursuant to European Directive 2002/96/EC in order to be recycled or dismantled to minimize its impact on the environment. For further information, please contact your local or regional authorities.

Electronic products not included in the selective sorting process are potentially dangerous for the environment and human health due to the presence of hazardous substances.

contents

Introduction

Welcome	2
---------	---

Installation

Know your washing machine/specification	4
---	---

Location	5
----------	---

Installation	5
--------------	---

Electrical connection	7
-----------------------	---

Operating

How to use	8
------------	---

Programme descriptions	12-13
------------------------	-------

Function buttons	13
------------------	----

ITCL fabric care symbols	13
--------------------------	----

Machine care

Care & maintenance	14
--------------------	----

Before calling service/troubleshooting	16
--	----

Guarantee	17
-----------	----

Service	17
---------	----

know your washing machine

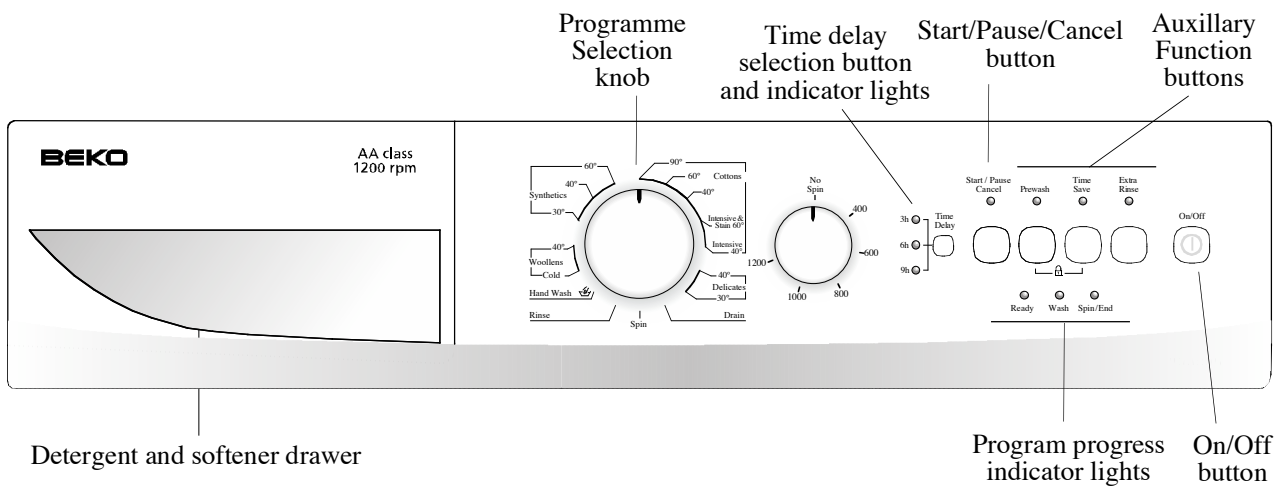
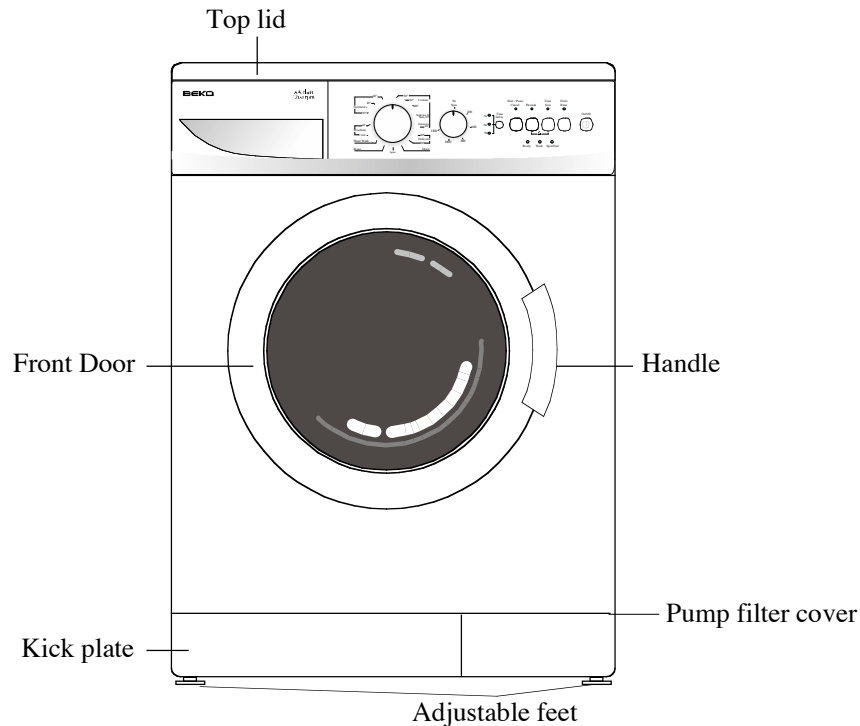

specification

Capacity (dry fabric)	5kg
Dimensions width x depth x height	60cm x 54cm x 85cm
Net weight	67 kg
Supply voltage	230 V~ 50Hz
Nominal current	10A
Motor power	300 watts
Heater power	2050 watts
Washing speed	52 rpm
Spin speed (max.)	1200 rpm

Because we continually strive to improve our products, we may change our specifications and designs without prior notice.

location

You can locate the washing machine anywhere (except bathrooms, showers and away from rain, damp places and water) as long as you have cold water supply, drainage and electrical connection alongside.

Ensure there is clearance each side of the machine to allow slight side ways movement during washing and spin drying.

Attention!

Never place your machine on a carpet. This prevents air circulation. The electrical components of the machine may overheat and may cause damage.

Please ensure the power, water supplies and waste are suitable, if in doubt, consult a qualified plumber or electrician.

Different methods of floor construction can result in an increase in vibration/noise during spin modes.

If these symptoms are experienced please ensure firstly that all four feet are in firm contact with the floor to minimise any out of balance vibration which may be generated.

Additional information is available by request.

In addition to this, washing machines should not be installed on carpet, foam backed laminate, or parquet flooring where the nature of these types of flooring can also contribute to the inefficient operation of the washing machine on the spin cycle.

installation

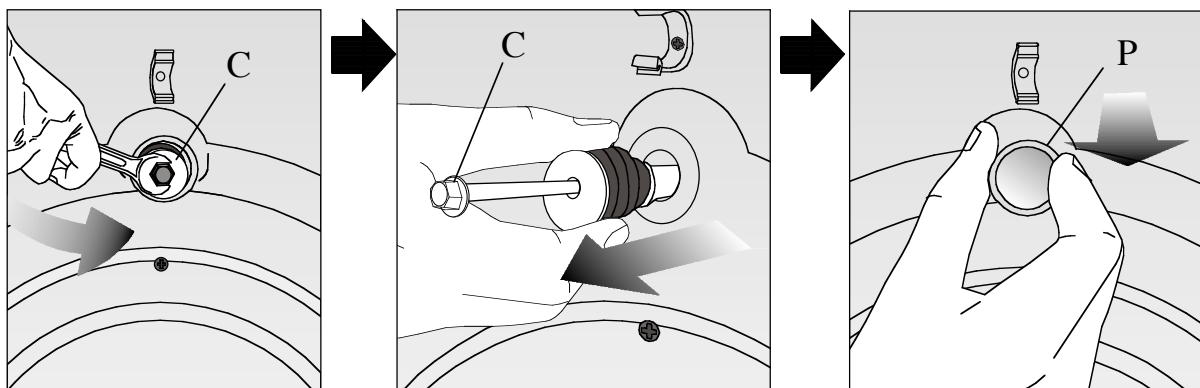

Removing transport safety bolts

The transport safety bolts must be removed before any operation of the machine.

- 1 Turn the bolt heads C anti-clockwise until the bolt can be partially withdrawn.
- 2 Remove them and the rubber bushes by pulling outwards. An up/down action and a small squirt of washing up liquid will ease removal.
- 3 Plastic plugs, supplied inside the protective bag, designated P, should be placed in the safety bolt holes as shown.

Attention! Keep the safety bolts for future transportation and reinstate them before transporting your machine. Never transport your machine without the transport bolts in position. Any resultant damage is not covered by the warranty.

Feet adjustment

To ensure quiet and stable operation, the machine should be positioned correctly and leveled. If the machine is unstable, adjust feet by loosening the plastic lock nut and screwing or unscrewing the feet until the machine is level. After positioning, tighten the lock nut.

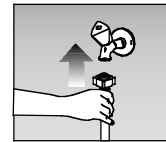
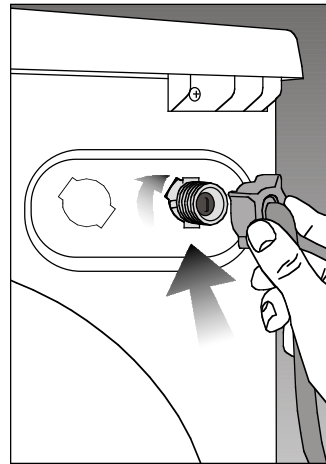
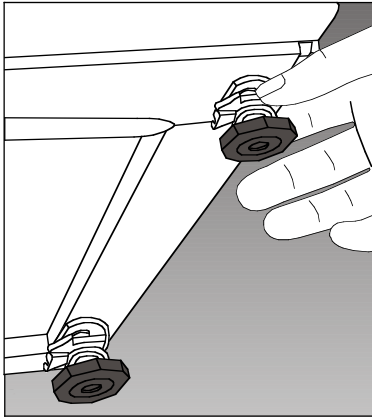

Water inlet connection

Your machine comes with cold water connection only.

Connect the cold water using the hose with blue printing or colour.

Cold water supply

For proper operation, the pressure of cold water should be between 1 and 10 bars. (1 bar corresponds to more than 8 litres per minute flow rate with a fully open tap.)

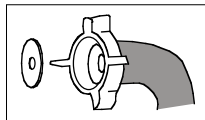

To prevent water leaks, sealing washers are supplied with the water inlet hose inside the machine. Place these on the hose end and tighten both ends fully.

In order to prevent any water leakage and damage, turn off the water tap when not in use. Connect the right angled end of the hose to the machine water inlet.

The washing machine must only be connected with the new hose provided and old hoses must not be reused.

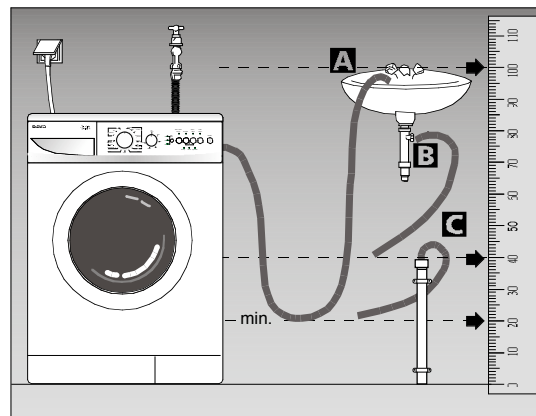

Drain hose

The drain hose should be placed and secured either at the side of the sink A, directly to the drain B or directly to the waste water inlet C.

- The hose should not be bent.
- Using method A, the drain hose should be secured with the elbow so that it can not be dislodged.
- The waste pipe must only be connected into the foul drains and not surface water drainage system.
- The hose should be placed between 20 and 80cm from the floor level and must not be extended otherwise the machine may not empty the waste water.
- The minimum diameter of any external pipe must be 32 mm.

electrical connection

Make sure that you have an earthed power outlet socket rated at 13 amps (minimum).

Attention!

If you use your machine as built-in, the socket must be reachable after installation, or a separate switch (which can disconnect the two poles) must be used in the installation.

Electrical requirements

Before you insert the plug into the wall socket make sure that the voltage and the frequency shown in the rating label corresponds to your electricity supply.

We recommend that this appliance be connected to the mains supply via a suitable switched and fused socket in a readily accessible position.

Should the mains lead of the appliance become damaged or need replacing at any time, it must be replaced by a special purpose made mains lead which can only be obtained from a Beko Authorised Service Agent.



Warning

This appliance must be earthed

If the fitted moulded plug is not suitable for your socket, then the plug should be cut off and an appropriate plug fitted.

The moulded plug on this appliance incorporates a 13A fuse. Should the fuse need to be replaced an ASTA approved BS1362 fuse of the same rating must be used. Do not forget to refit the fuse cover. In the event of losing the fuse cover, the plug must not be used until a replacement fuse cover has been fitted.

Colour of the replacement fuse cover must be the same colour as that visible on the pin face of the plug. Fuse covers are available from any good electrical store.

In order to avoid hazards, damaged supply cord should be replaced by the manufacturer, its service agent or similarly qualified people.



Important Fitting a different plug

As the colours of the wires in the mains lead of this appliance may not correspond with the coloured markings identifying the terminals on your plug, proceed as follows:

- 1 Connect the green - yellow or green (earth) wire to the terminal in the plug marked 'E' or with the symbol \perp or coloured green and yellow or green.
- 2 Connect the blue (neutral) wire to the terminal in the plug marked 'N' or coloured black.
- 3 Connect the brown (live) wire to the terminal in the plug marked 'L' or coloured red.

With the alternative plugs a 13A fuse must be fitted either in the plug or adaptor or in the main fuse box. If in doubt contact a qualified electrician.

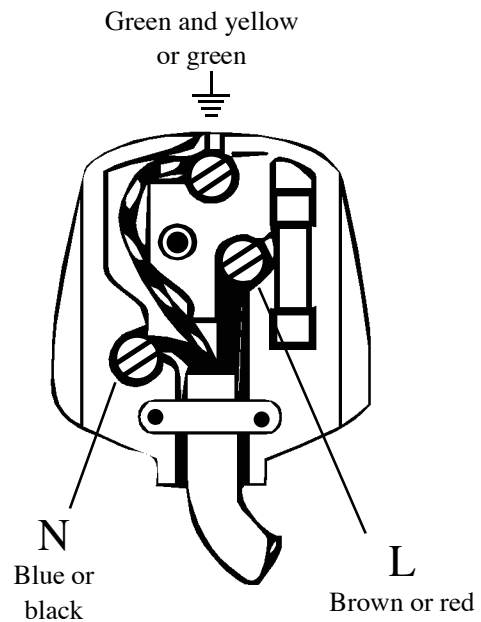

Sorting laundry

Sort the laundry according to the following groups and wash them separately:

- White and colour fast fabrics
- Non-fast, coloured fabrics
- Delicate fabrics (silk, rayon etc.)
- Woollens
- Hand knits should be placed inside out in the machine.

Be sure to empty pockets and remove any belts, buckles, pins, etc. from the clothing. Never exceed the maximum load of the selected programme (see page 13)

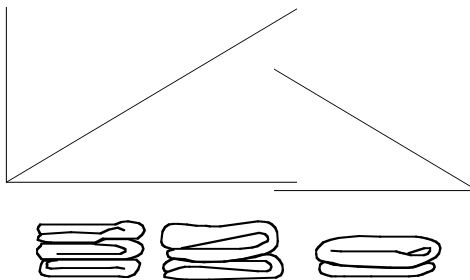

Loading the machine

Make sure power button is off.

- 1 Pull the door handle.
- 2 Place the fabrics uniformly inside the machine. Make sure that there is no clothing obstructing the door.
- 3 Close the door by pushing lightly.

If the door does not close completely, the machine will not start. This is a safety precaution. The front door is locked until the end of the washing programme and it cannot be opened for about 2 minutes following the end of the programme.

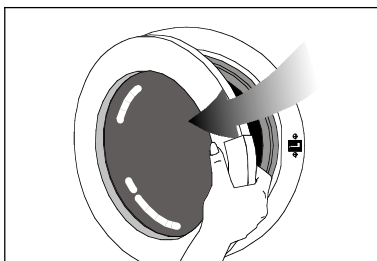

Programme selection

Select the programme after referring to the programme descriptions and table on page 12-13.

Warning! Always switch on the machine before selecting your wash programme.

- 1 Turn the programme selection knob to the desired programme. You have now selected both the washing programme and the washing temperature at the same time.
- 2 If you don't change the spin speed, default spin speed would be used.

Programme selection indicator

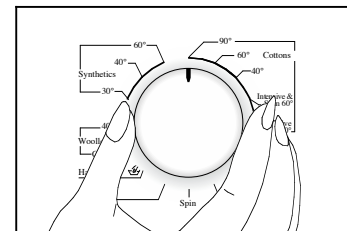

Function selection

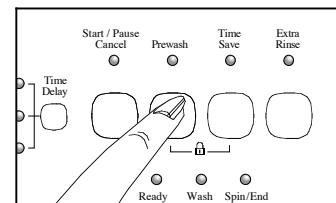

Select the desired auxiliary function such as Time Save, Extra Rinse, etc. before you push the "Start/Pause/Cancel" button. Indicator light of the function selected will be on. Door will be locked after pressing "Start/Pause/Cancel" button.

To cancel the selected function, press "Start/Pause/Cancel" button. Your machine will pause. Any auxiliary function button can be selected now if needed, see page 13.

You have to start the programme by repressing the "Start/Pause/Cancel".

Auxiliary functions

It is not possible to activate all auxiliary functions in all wash programs. If any auxiliary function is selected, its indicator light will be on.

It is restricted to select some auxiliary functions together. For example, if the cotton programme is selected, “Time Save” and “pre-wash” functions can not be selected at the same time. If “Pre-wash” button is selected first and the “Time Save” function next, the indicator light of the pre-wash function will go off as it is not active any more.

Detergent and softener dispenser

- 1 Open the drawer.
- 2 Put powder detergent and the fabric softener in the compartments as shown.
- 3 Close the detergent and softener drawer.

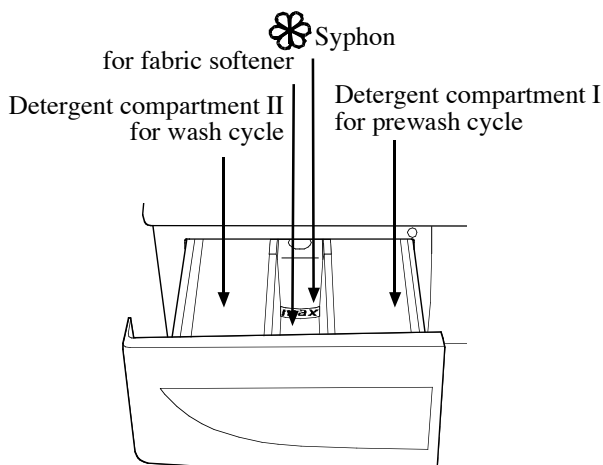

Powders and liquids

The performance of the washing machine depends on the effectiveness of the detergent. Stains can remain if low quality detergents are used.

- Only use powders specific for automatic washers, otherwise over foaming and poor washing performance will be experienced.
- Do not use liquid detergent in your detergent drawer. Only use liquid detergents with a dosing ball.
- Do not attempt to use detergents and bleaching agents that contain chlorine and sulphur.
- Concentrated softener may clog the syphon, in this case add some water to the softener liquid.

Amounts

Follow the manufacturer’s recommended amount of detergent given on the packaging.

Adjust the amount according to the dirt level, the amount of fabric and the softness of the water. For example, if a small amount of clothing is washed, put in half the amount of detergent normally required.

- Do not fill the fabric softener above the max mark as any excess amount will mix into the wash water and you will have to re-fill the compartment.

Starting

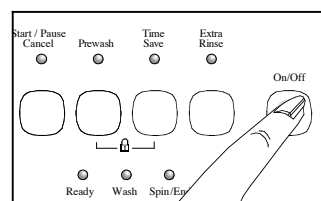

Attention!

Before any operation of the machine check the following:

- Have you closed the door?
- The tap open?
- Is the drain hose placed and secured properly?
- Is power connected?

When you press the On/Off button, your machine is ready to select the desired programme. To switch the machine off, repress the On/Off button.

Washing can only start when the “Start/Pause/Cancel” button is pressed.

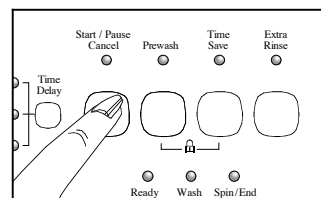

Attention!

Pressing the On/Off button does not mean that the washing operation will start! To start the washing, press the Start/Cancel/Pause button!

Child Lock

To prevent operation by children you may activate child lock while the machine is in operation. In order to activate the child lock, press Prewash and Time Save function keys simultaneously for 3 seconds after the washing programme has started. The prewash indicator light will flash continuously.

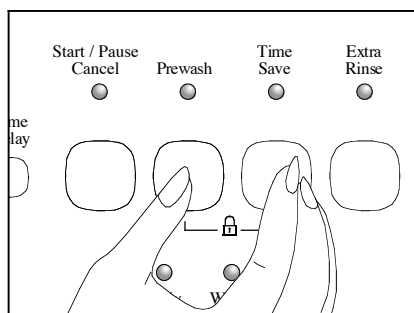

Only the on/off button can be used when child lock option is selected.

To start a new program after the program is over or to adjust with the program, child lock should be deactivated. The child lock will be deactivated when the same keys are pressed together for 3 seconds and the Prewash indicator light will go out.

Programme operation

During the machine's operation, the indicator lights on the programme follower will light up as each stage is reached.

Softener is added in the softener compartment, it will be used in the last rinse cycle.

Programme Follower

If the machine is on, a programme can be followed by means of the programme follower. If a washing step is over and the next step is started, the indicator light of the previous step will continue to light.

When the washing operation is finished, then all related washing steps on the programme follower will be lit.

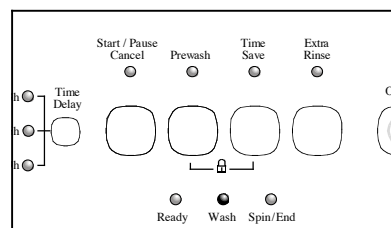

Additional Laundry

When loading laundry, make sure the garments are unfolded and are loosely placed in the drum.

Press the Start/Cancel/Pause button. If the water level does not exceed the lower level of the door, in 1 to 2 minutes, ready indicator light will come on. This indicates that the door may be opened to add more laundry.

Press Start/Cancel/Pause button again to let the programme continue.

Re-Selection / Cancellation of Functions After Operation Start

In order to change auxiliary functions, spin speed, push the Start/Pause/Cancel button for a short time to pause the program. Change the auxiliary functions or spin speed from those allowed by the selected program. Then push the Start/Pause/Cancel button for a short time to continue the program.

End of the programme

When the program ends “ Spin/End” indicator light will come on. The door can be opened after about 2 minutes and machine is ready for next washing. Press “On/Off” to turn the machine off.

Unloading

The machine stops automatically after programmes are completed.

- 1 In about 2 min, the door will unlock. Open the door.
- 2 Press the On/Off button to switch off the machine.
- 3 Unload the machine and leave the front door open. Check to see if there is any water left in the door gasket. If so, remove with a soft cloth.

Time Delay

Allows you to delay the program start by 3, 6 or 9 hours.

When time delay button is pressed once 3 hours delay is adjusted and indicator light will come on. If same key is pressed once more delay will be 6 hours, and if it is pressed once more 9 hours delay would have been selected. If time delay button is pressed again delay will be cancelled. After selection of time delay when “Start/Pause/Cancel” is pressed the program will start with delay. During delay period door can be opened or laundry can be added

After time delay is initiated by pressing “Start/Pause/Cancel” you can switch machine to “Pause” mode and change delay time.

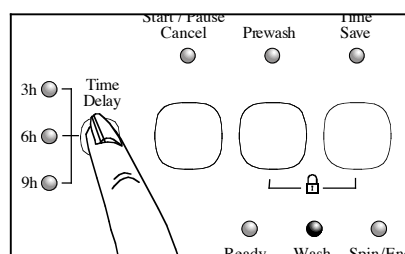

Programme Cancellation

To cancel a programme before it starts to wash press “Start/Pause/Cancel” for 3 seconds. “Start/Pause/Cancel” and the other indicator lights will be off. You can select a new program and start washing.

If the programme has started and you want to cancel it, press Start/Pause button for 3 seconds. The programme will move to the “spin” step and spin indicator will light. Machine will start to pump for draining and the door can be opened after 1-2 minutes.

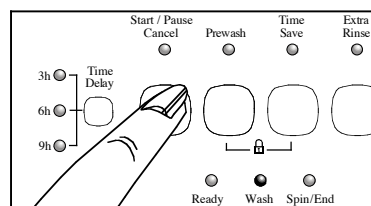

programme descriptions

Cottons

Cottons 90, Cottons 60, Cottons 40, Intensive & Stain 60, Intensive 40 Programmes

These programmes are used for white and coloured cotton and linen fabrics.

Cottons 90 Programme with main wash (main wash, 3 rinses, 3 intermediate spin, final spin). The set temperature is 90°C for this programme.

Cottons 60 Programme with main wash (main wash, 3 rinses, 3 intermediate spin, final spin). The set temperature is 60°C for this programme.

Cottons 40 Programme with main wash (main wash, 3 rinses, 3 intermediate spin, final spin). The set temperature is 40°C for this programme.

Intensive 60 Intensive wash (main wash, 3 rinses, 2 intermediate spin, final spin). The set temperature is 60°C for this programme.

Intensive 40 Intensive wash (main wash, 3 rinses, 2 intermediate spin, final spin). The set temperature is 40°C for this programme.

Synthetics

Synthetics 60, Synthetics 40, Synthetics 30, Delicates 40, Delicates 30 Programmes

These programmes are designed for synthetic fabrics, nylon clothing, curtains and non iron wool fabrics. The clothing is washed gently with more water.

Synthetics 60 Normal programme for synthetics (main wash, 3 rinses, 3 intermediate spin, final spin). The set temperature is 60°C for this programme.

Synthetics 40 Normal programme for synthetics (main wash, 3 rinses, 3 intermediate spin, final spin). The set temperature is 40°C for this programme.

Synthetics 30 Normal programme for synthetics (main wash, 3 rinses, 3 intermediate spin, final spin). The set temperature is 30°C for this programme.

Delicates 40 Delicate programme. (main wash, no intermediate spin, 3 rinses, final spin)

Delicates 30 Delicate programme. (main wash, no intermediate spin, 3 rinses, final spin)

Woollens

Woollens 40, Woollens cold, Handwash Programmes

Woollens 40 Woollen programme (main wash, 3 rinses, 1 intermediate spin, final spin). The set temperature is 40°C for this programme.

Woollens Cold Woollen programme (main wash, 3 rinses, 1 intermediate spin, final spin).

Handwash 30 Special programme for hand wash marked wool and silk. (main wash, 2 rinses, no intermediate spin, final spin). The set temperature is 30°C.

Program	Type of laundry	Max Load (kg)	Program Duration (min.)	Water Consumption (lt)	Energy Consumption (kWh)	Prewash	Time Save	Extra Rinse
Cottons 90	Heavy soiled light Durable fabrics made of cotton and linen	5	150	50	1.70	•	•	•
Cottons 60*	Normal soiled light cotton and linen durable to heat	5	135	49	0.95	•	•	•
Cottons 40	Less soiled light cotton and linen sensitive to heat	5	125	49	0.65	•	•	•
Intensive & Stain 60	Heavy soiled light Durable fabrics made of cotton and linen	6	160	55	1.00			•
Intensive 40	Heavy soiled light Durable fabrics made of cotton and linen (baby clothes etc.)	5	160	55	0.55			•
Synthetics 60	Normal soiled light cotton/synthetic blended durable to heat	2,5	115	50	0.95	•	•	•
Synthetics 40	Less soiled light cotton/synthetic blended durable to heat	2,5	105	50	0.55	•	•	•
Synthetics 30	Very Less soiled light or cotton/synthetic blended sensitive to heat	2,5	90	50	0.30	•	•	•
Delicates 40	Delicate, sensitive synthetic, cotton blended	2	70	55	0.35			•
Delicates 30	Delicate, sensitive synthetic, cotton blended	2	65	55	0.25			•
Woollen 40	Woollen and delicate blended with machine wash label	1,5	55	50	0.30			•
Woollen Cold	Woollen and delicate laundry with machine wash sign	1,5	45	50	0.03			•
Handwash 30	Special program for silk, cashmere or laundry with no machine wash sign	1	40	35	0.15			•
Rinse	Rinse Program	5	23	11	0.04			•
Spin	Spin Program	5	11	–	0.03			•
Drain	Pump Program	–	2	–	–			•

• Options available
* Default function selection

(*) Energy Labelling program acc. to EN 60456:1999 ve IEC 60456 Ed.4 2001 (model Dependent)

function buttons

Prewash

A pre-wash is only worth while with heavily soiled laundry. Without prewash you save energy, water, washing powder and time.

Extra rinse

Using this function, you can have 4 rinse cycles instead of 3. The additional rinse will extract more detergent for sensitive skin.

Time Save

Shortens washing time for lightly soiled fabrics. This function can be used for all cotton and synthetic programs.

ITCL fabric care symbols

Descriptions of the international textile care label (ITCL) symbols.

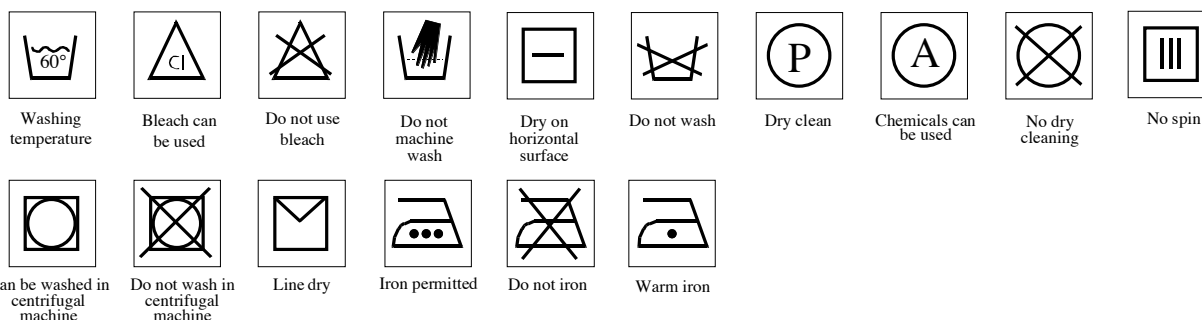

Detergent dispenser

It is necessary to remove the detergent dispenser drawer from time to time to clean away residue and ensure correct operation.

To remove

Pull out the drawer and press down on the coloured insert to release it fully from its housing. Wash the drawer in warm water to remove detergent and softener residue and before replacing wipe it dry.

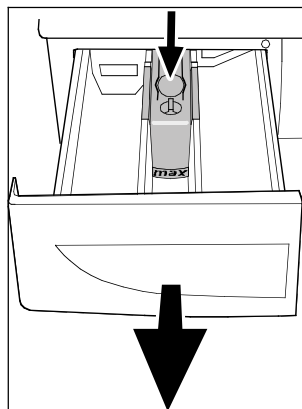

Syphon

The syphon (coloured insert in the dispenser) must be cleaned. Remove the dispenser drawer and lift out the syphon and wash in warm water to remove any softener residue. Refit ensuring that the syphon is correctly fitted before use.

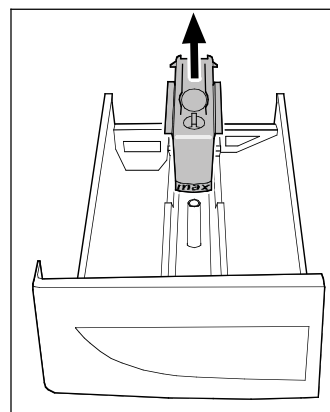

Maintenance wash

If you regularly use low temperature programs, for example 40°C, certain detergents cause build up of greasy deposits over time. We recommend a hot maintenance wash once every 6 months to clear such accumulation of residue.

Simply run the wash programme “Cotton 90” without laundry using the usual amount of detergent.

Water intake filter

At the end of the water intake connection and water inlet hose-tap side there are filters.

These filters prevent any dirt and objects passing into the machine. It is advisable that these filters should be cleaned every 30-40 washes. To clean these filters, first turn the tap off. Then, disconnect the hose and clean the filter with a thin brush. If the filter is very dirty, you may clean it by pulling out with pliers. To clean the filter at the tap side of the hose, pull it out by hand and clean the filter under tap water. Ensure that the sealing rings are in place before reassembly.

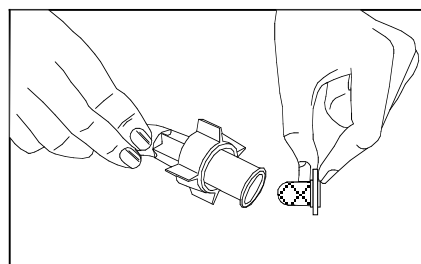
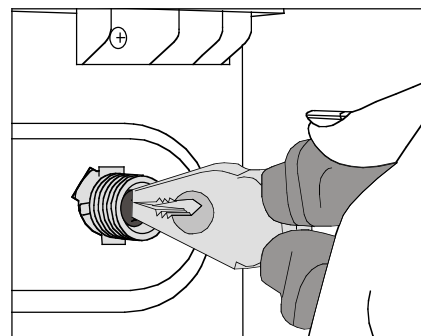

Pump filter warning

When the appliance is in use and depending on the programme selected there can be hot water in the filter. Never remove the filter during a wash cycle, always wait until the appliance has finished the cycle, and is empty. When replacing the filter, ensure it is securely retightened so as to stop leaks and young children being able to remove it.

Hoses

To prevent any leakage, check the hoses every two years. If the machine is placed in cold ambient temperatures, the water remaining inside the pump and hoses should be drained to prevent freezing, empty the water intake hoses by disconnecting from taps.

Drum

Do not leave any metal objects (pins, needles, etc.) inside the drum. These objects may cause rust on the drum surface and stain clothing. Do not clean the drum with abrasive materials.

Cleaning the pump filter

Warning

Hot water danger! Always ensure that the drum is completely empty. Be careful while taking out the filter!

Switch off the appliance. Open the filter cover by pulling at the holder as shown.

Open the filter as shown turning the cap anti-clockwise, drain the water. If there are any foreign parts inside the filter, take them out and clean the filter before replacing it. Then, place the filter while turning it clockwise. When securely tightened, close the filter cover.

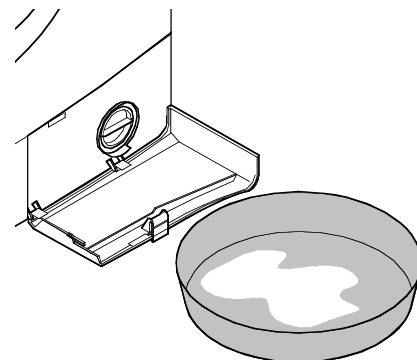
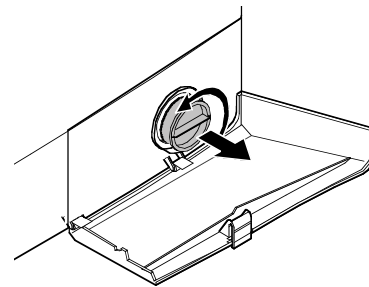
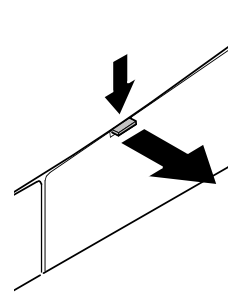

before calling service/troubleshooting

You turned the machine on, but the indicator light is not lit

Have you plugged in and switched on at the socket? Check the power cable, or for a blown fuse. Check the front door is properly closed.



After your machine starts operation, if Start/Pause/Cancel button starts flashing then door is not locked. Open and close the door again and press Start/Pause/Cancel button to begin washing program again.

Machine does not take in water

- Check the door for proper closure. Either tap closed or water inlet filter is clogged.
- Turn the programme selector to the programme required.
- If the “wash” led on the program progress display and Start/Pause/Cancel button are flashing either there is no water or tap is off. Check your taps. Press Start/Pause/Cancel button. If the problem persists unplug your machine, turn off tap water and call authorized service.



Water is syphoned / discharged

Check if the drain hose is positioned as described on page 6.



If the machine vibrates or is too noisy

- Have all the transit bolts and packing been removed?
- Is the machine touching something?
- Are all the feet resting firmly on the ground?
- Have the lock nuts been secured?
- Has the recommended wash load been exceeded? (See page 12 for max program loads)

Water coming from beneath the machine

Check the water inlet and drain hoses. Tighten the connections. The washers of the hoses may be worn out or the pump filter may not have been closed properly.



Foam coming out of the detergent dispenser

Check whether your detergent is suitable for automatic machines. Next time use less detergent.



Pump does not drain water

Check Rinse Hold button has not been selected in error. Clean the pump filter. Do not attempt to remove the filter if the machine is full of water. Check whether the drain hose is bent or not. If there is a need to clean the pump filter, refer to the pump filter cleaning section on page 15.

Pre-wash indicator light on the program follower is blinking

Cancel child lock

guarantee

Your new Beko product is guaranteed against the cost of breakdown repairs for twelve months from the date of the original purchase.

What is covered?

- Repairs necessary as a result of faulty materials, defective components or manufacturing defect.
- The cost of functional replacement parts, but excluding consumable items.
- The labour costs of a Beko approved repairer to carry out the repair.

What is not covered?

- Transit, delivery or accidental damage or misuse and abuse.
- Cabinet or appearance parts, including knobs, flaps, handles or container lids.
- Accessories or consumable items including but not limited to, ice trays, scrapers, cutlery baskets, filters and light bulbs.
- Repairs required as a result of unauthorised repair or inexperienced installation that fails to meet the requirements contained in the user instruction book.
- Repairs to products used on commercial or non-residential household premises.
- Loss of frozen food in freezers or fridge/freezers. (Food loss insurance is often included within your household contents insurance policy, or may be available

separately from your retailer).

Important notes.

- Your Beko product is designed and built for domestic household use only.
- The guarantee will be void if the product is installed without indicator light or used in commercial or non-residential domestic household premises.
- The product must be correctly installed with indicator light, located and operated in accordance with the instructions contained in the User Instructions Booklet provided.
- Professional installation by a qualified Electrical Domestic Appliance Installer is recommended for all Washing Machines, Dishwashers and Electric Cookers
- Gas Cookers must only be installed by a CORGI (or BORD GAIS) registered Gas Installer.
- The guarantee is given only within the boundaries of the United Kingdom and the Republic of Ireland.
- The guarantee is applicable only to new products and is not transferable if the product is resold.
- Beko disclaims any liability for incidental or consequential damages.
- The guarantee does not in anyway diminish your statutory or legal rights.

service

Please keep your purchase receipt or other proof of purchase in a safe place; you will need to have it should the product require attention under guarantee.

You should also complete the details below; it will help us assist you when requesting service. (The model number is printed on the Instruction Booklet and the serial number is printed on the Rating Label affixed to the appliance)

Model No: _____

Serial No: _____

Retailer: _____

Date of purchase: _____

For service under guarantee simply telephone the appropriate number below

UK Mainland & Northern Ireland
Fridges & Freezers 0870 241 0638
Electric Cookers 0870 241 1320
Gas & Dual Fuel Cookers 0870 241 1321
Washing Machines & Dishwashers 0870 241 0357

Republic of Ireland
All Refrigeration, 01 862 3411
All Cookers
Washing Machines & Dishwashers

Before requesting service please check the trouble-shooting guide in the Operating Instructions as a charge may be levied where no fault is found even though your product may still be under guarantee.

Service once the manufacturers guarantee has expired.

If you have purchased an extended guarantee please refer to the instructions contained within the extended guarantee agreement document. Otherwise please call the appropriate number above where service can be obtained at a charge.

Should you experience any difficulty in obtaining service please contact the Beko Customer Help-Line.

Tel: 0870 774 1050
e-mail:service@beko.co.uk

BEKO



**Beko plc Beko House, Caxton Way, Watford
Hertfordshire, WD18 8UF**

Tel: 08707741050

Fax: 08707741090

Email: service@beko.co.uk

www.beko.co.uk

Free Manuals Download Website

<http://myh66.com>

<http://usermanuals.us>

<http://www.somanuals.com>

<http://www.4manuals.cc>

<http://www.manual-lib.com>

<http://www.404manual.com>

<http://www.luxmanual.com>

<http://aubethermostatmanual.com>

Golf course search by state

<http://golfingnear.com>

Email search by domain

<http://emailbydomain.com>

Auto manuals search

<http://auto.somanuals.com>

TV manuals search

<http://tv.somanuals.com>