

Washing Machine

User Manual

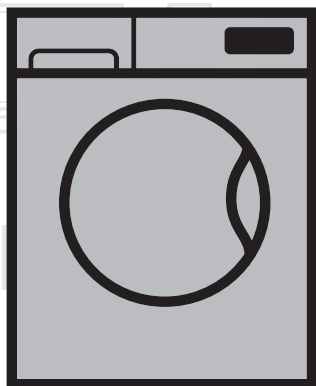

WMI 71442

EN

CE

beko

Document Number= 2820525508/ 27-12-16.(13:47)

Please read this user manual first!





Dear Customer,

Thank you for preferring an Beko product. We hope that you get the best results from your product which has been manufactured with high quality and state-of-the-art technology. Therefore, please read this entire user manual and all other accompanying documents carefully before using the product and keep it as a reference for future use. If you handover the product to someone else, give the user manual as well. Follow all warnings and information in the user manual.

Remember that this user manual is also applicable for several other models. Differences between models will be identified in the manual.

Explanation of symbols

Throughout this user manual the following symbols are used:

	Important information or useful hints about usage.
	Warning for hazardous situations with regard to life and property.
	Warning for electric shock.
	Packaging materials of the product are manufactured from recyclable materials in accordance with our National Environment Regulations.

Do not dispose of the packaging materials together with the domestic or other wastes. Take them to the packaging material collection points designated by the local authorities.



This product was manufactured using the latest technology in environmentally friendly conditions.

TABLE OF CONTENTS

1 General safety instructions	4	5.7 Special programmes.....	23
1.1 Life and property safety	4	5.8 Temperature selection	23
1.2 Children's safety	4	5.9 Spin speed selection	24
1.3 Electrical safety	5	5.10 Programme and consumption table ..	25
1.4 Hot surface safety.....	6	5.11 Auxiliary function selection	27
1.5 Compliance with WEEE Directive	6	5.12 Time display.....	28
1.6 Package information	6	5.13 Starting the programme	29
1.7 Intended use	6	5.14 Progress of programme	29
2 Your washing machine	7	5.15 Loading door lock	29
2.1 Overview	7	5.16 Changing the selections after programme has started.....	29
2.2 Package Contents	8	5.17 Child Lock	30
2.3 Technical specifications.....	9	5.18 Cancelling the programme	30
3 Installation	10	5.19 Machine is in Rinse Hold mode.....	31
3.1 Appropriate installation location	10	5.20 End of programme	31
3.2 Removing packaging reinforcement ..	10	5.21 Your machine is equipped with a "Standby Mode".....	31
3.3 Removing the transportation locks ...	10	6 Maintenance and cleaning	32
3.4 Connecting water supply.....	11	6.1 Cleaning the detergent drawer.....	32
3.5 Connecting to the drain	11	6.2 Cleaning the loading door and the drum	32
3.6 Adjusting the feet.....	12	6.3 Cleaning the body and control panel ..	33
3.7 Electrical connection	12	6.4 Cleaning the water intake filters.....	33
4 Preparation	14	6.5 Draining remaining water and cleaning the pump filter.....	33
4.1 Sorting the laundry.....	14	7 Troubleshooting	35
4.2 Preparing laundry for washing	15	8 BUILT-IN INSTALLATION	41
4.3 Things to be done for energy saving ..	15		
4.4 Initial use.....	15		
4.5 Correct load capacity	16		
4.6 Loading the laundry.....	16		
4.7 Using detergent and softener.....	16		
4.8 Tips for efficient washing.....	19		
5 Operating the product	20		
5.1 Control panel	20		
5.2 Display symbols	20		
5.3 Preparing the machine	21		
5.4 Programme selection	21		
5.5 Main programmes	21		
5.6 Additional programmes	22		

1 General safety instructions

This section includes security instructions which may help prevent the injuries and material damage risks. All kinds of warranties shall be invalid if these instructions are not observed.

1.1 Life and property safety

- Never place the product on a carpet-covered floor. Electrical parts will get overheated since air cannot circulate from under the device. This will cause problems with your product.
- Unplug the product if it is not in use.
- Always have the repairing procedures carried out by the Authorised Service Agent. Manufacturer shall not be held liable for damages that may arise from procedures carried out by unauthorised persons.
- The water supply and draining hoses must be securely fastened and remain undamaged. Otherwise, water leak may occur.
- While there is still water inside the product, never open the loading door or remove the filter. Otherwise, risk of flooding and injury from hot water will occur.
- Do not force open the locked loading door. Door can be opened a few minutes after the washing cycle ends. In case of forcing the loading door to open, the door and the lock mechanism may get damaged.
- Use detergents, softeners and supplements suitable for automatic washing machines only.
- Follow the instructions on the label of textiles and the detergent package.

1.2 Children's safety

- This product can be used by the children who are at the age of 8 and over and the people whose physical, sensory or mental skills are not fully developed or who do not have necessary required experience and knowledge as long as they are supervised or trained about the safe use of the product and its risks. Children should not play with the device. Cleaning and maintenance works should not be performed by children unless they are supervised by someone. Children of less than 3 years should be kept away unless continuously supervised.
- Packaging materials may be dangerous for the children. Keep packaging materials in a safe place away from reach of the children.
- Electrical products are dangerous for the children. Keep the children away from the product when it is in use. Do not allow them to play with the product. Use child lock to prevent children from intervening with the product.
- Do not forget to close the loading door when leaving the room where the product is located.

Important instructions for safety and environment

- store all detergents and additives in a safe place away from the reach of the children by closing the cover of the detergent container or sealing the detergent package.

1.3 Electrical safety

- If the product has a failure, it should not be operated unless it is repaired by the Authorised Service Agent. Risk of electric shock!
- This product is designed to resume operating in the event of powering on after a power interruption. If you wish to cancel the programme, see “Cancelling the programme” section.
- Plug the product into a grounded outlet protected by a 13 A fuse. Do not neglect to have the grounding installation made by a qualified electrician. Our company shall not be liable for any damages that will arise when the product is used without grounding in accordance with the local regulations.
- Do not wash the product by spraying or pouring water onto it! Risk of electric shock!
- Never touch the power cable plug with wet hands! Do not grab the power cord to unplug the machine, always unplug it by holding the socket with one hand, and pulling the plug with the other hand.
- Product should be unplugged during installation, maintenance, cleaning and repair procedures.
- If the power cable is damaged, it must be replaced by the manufacturer, after sales service or a similarly qualified person (preferably an electrician) or someone designated by the importer in order to avoid possible risks.

Important instructions for safety and environment

1.4 Hot surface safety



While washing the laundry at high temperatures, the loading door glass will get hot. Considering this fact, during washing operation keep the children away from the loading door of the product to prevent them touching it.

1.5 Compliance with WEEE Directive



This product complies with EU WEEE Directive (2012/19/EU). This product bears a classification symbol for waste electrical and electronic equipment (WEEE).

This product has been manufactured with high quality parts and materials which can be reused and are suitable for recycling. Do not dispose of the waste product with normal domestic and other wastes at the end of its service life. Take it to the collection center for the recycling of electrical and electronic equipment. Please consult your local authorities to learn about these collection centers.

Compliance with RoHS Directive:

The product you have purchased complies with EU RoHS Directive (2011/65/EU). It does not contain harmful and prohibited materials specified in the Directive.

1.6 Package information

Packaging materials of the product are manufactured from recyclable materials in accordance with our National Environment Regulations. Do not dispose of the packaging materials together with the domestic or other wastes. Take them to the packaging material collection points designated by the local authorities.

1.7 Intended use

- This product has been designed for domestic use. It is not for commercial purposes or it should not be used out of its intended use.
- The product must only be used for washing and rinsing of laundry that are marked accordingly.
- The manufacturer waives any responsibility arisen from incorrect usage or transportation.
- The service life of your product is 10 years. During this period, original spare parts will be available to operate the appliance properly.

2 Your washing machine

2.1 Overview

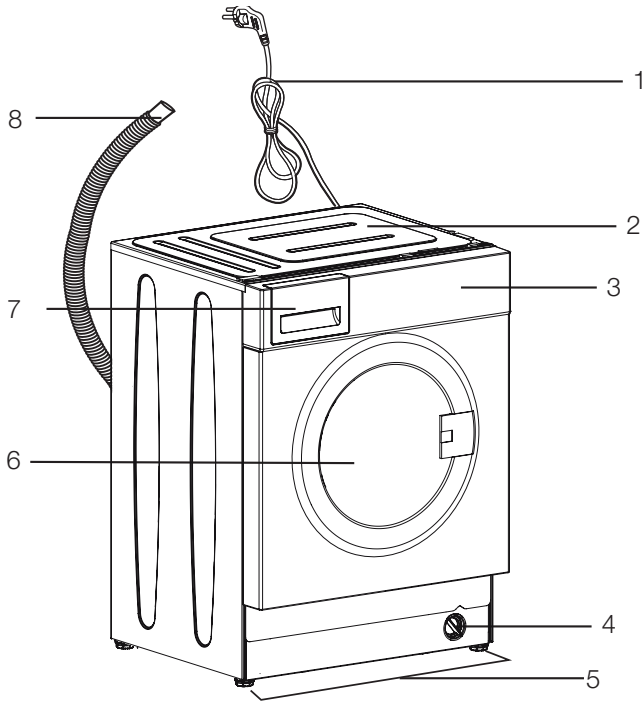

- 1- Power cable
- 2- Top panel
- 3- Control panel
- 4- Filter cap

- 5- Adjustable feet
- 6- Loading door
- 7- Detergent drawer
- 8- Drain hose

Your washing machine

2.2 Package Contents

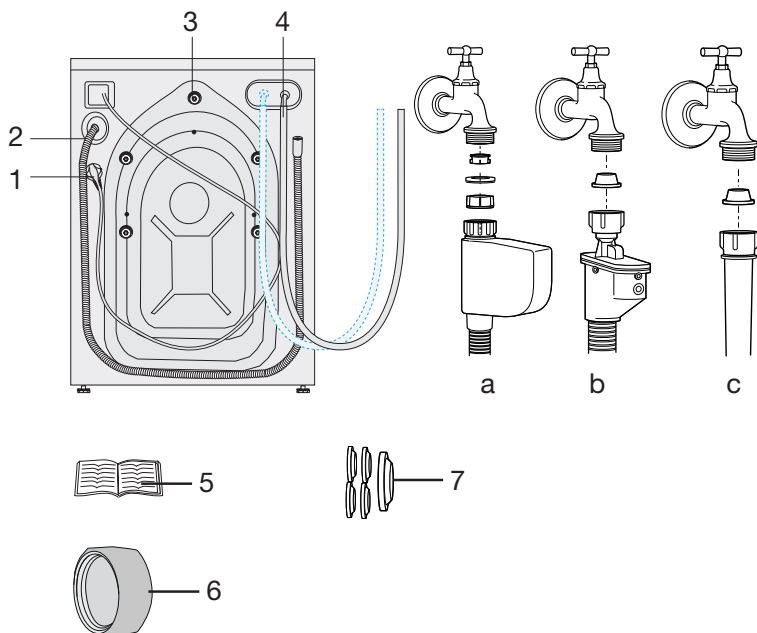

1- Power cable

2- Drain hose

3- Transportation safety bolts *

4- Mains water inlet hose (One of the following filter types is used for the mains hose connection.)

a- Electronical water shut-off

b- Mechanical water shut-off

c- Standard

5- User Manual

6- Blind plug**

7- Plastic plug group

* Number of transportation safety bolts may change depending on the model of your machine.

** This is supplied if your machine is equipped with double water inlet.



Your washing machine

2.3 Technical specifications

Complying Commission Delegated Regulation (EU) No 1061/2010	
Supplier name or trademark	Beko
Model name	WMI71442
Rated capacity (kg)	7
Energy efficiency class / Scale from A+++ (Highest Efficiency) to D (Lowest Efficiency)	A++
Annual Energy Consumption (kWh) ⁽¹⁾	194
Energy consumption of the standard 60°C cotton programme at full load (kWh)	1.001
Energy consumption of the standard 60°C cotton programme at partial load (kWh)	0.838
Energy consumption of the standard 40°C cotton programme at partial load (kWh)	0.652
Power consumption in 'off-mode' (W)	0.200
Power consumption in 'left-on mode' (W)	1.000
Annual Water Consumption (l) ⁽²⁾	9020
Spin-drying efficiency class / Scale from A (Highest Efficiency) to G (Lowest Efficiency)	B
Maximum spin speed (rpm)	1400
Remaining moisture Content (%)	53
Standard cotton programme ⁽³⁾	Cotton Eco 60°C and 40°C
Programme time of the standard 60°C cotton programme at full load (min)	160
Programme time of the standard 60°C cotton programme at partial load (min)	145
Programme time of the standard 40°C cotton programme at partial load (min)	130
Duration of the left-on mode (min)	N/A
Airborne acoustical noise emissions washing/spinning (dB)	51/66
Built-in	Yes
Height (cm)	82
Width (cm)	60
Depth (cm)	54
Net weight (±4 kg.)	71
Single Water inlet / Double Water inlet	• / -
• Available	
Electrical input (V/Hz)	230 V / 50Hz
Total current (A)	10
Total power (W)	2200
Main model code	8811
⁽¹⁾ Energy Consumption based on 220 standard washing cycles for cotton programmes at 60°C and 40°C at full and partial load, and the consumption of the low-power modes. Actual energy consumption will depend on how the appliance is used.	
⁽²⁾ Water consumption based on 220 standard washing cycles for cotton programmes at 60°C and 40°C at full and partial load. Actual water consumption will depend on how the appliance is used.	
⁽³⁾ "Standard 60°C cotton programme" and the "standard 40°C cotton programme" are the standard washing programmes to which the information in the label and the fiche relates and these programmes are suitable to clean normally soiled cotton laundry and that they are the most efficient programmes in terms of combined energy and water consumption.	
Technical specifications may be changed without prior notice to improve the quality of the product.	

3 Installation

To make the product ready for use, review the information in the user manual and make sure that the electricity, tap water supply and water drainage systems are appropriate. If they are not, call a qualified technician and plumber to have any necessary arrangements carried out.

	<p>Preparation of the location and electrical, tap water and waste water installations at the place of installation is under customer's responsibility.</p> <p>Make sure that the water inlet and discharge hoses as well as the power cable are not folded, pinched or crushed while pushing the product into its place after installation or cleaning procedures.</p>
	<p>WARNING: Manufacturer shall not be held liable for damages that may arise from procedures carried out by unauthorised persons.</p>
	<p>WARNING: Prior to installation, visually check if the product has any defects on it. If so, do not have it installed. Damaged products cause risks for your safety.</p>

3.1 Appropriate installation location



- Place the machine on a rigid floor. Do not place it on a long pile rug or similar surfaces.
- Total weight of the washing machine and the dryer -with full load- when they are placed on top of each other reaches to approx. 180 kilograms. Place the product on a solid and flat floor that has sufficient load carrying capacity!
- Do not place the product on the power cable.
- Do not install the product at places where temperature may fall below 0°C.
- Place the product at least 1 cm away from the edges of other furniture.

3.2 Removing packaging reinforcement

Tilt the machine backwards to remove the packaging reinforcement. Remove the packaging reinforcement by pulling the ribbon.



3.3 Removing the transportation locks

	<p>WARNING: Do not remove the transportation locks before taking out the packaging reinforcement.</p>
	<p>WARNING: Remove the transportation safety bolts before operating the washing machine! Otherwise, the product will be damaged.</p>

1. Loosen all the bolts with a suitable spanner until they rotate freely .

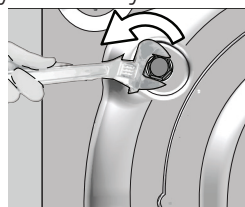

2. Remove transportation safety bolts by turning them gently.

Installation

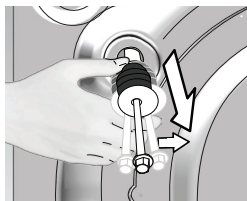

3. Attach the plastic covers supplied in the User Manual bag into the holes on the rear panel.

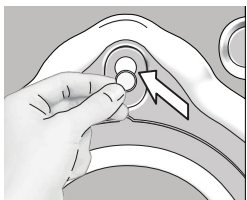

Tighten all hose nuts by hand. Never use a tool when tightening the nuts.

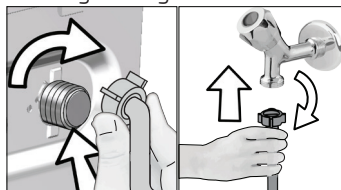

Keep the transportation safety bolts in a safe place to reuse when the washing machine needs to be moved again in the future.

Never move the product without the transportation safety bolts properly fixed in place!

3.4 Connecting water supply



The water supply pressure required to run the product is between 1 to 10 bars (0.1 - 1 MPa). It is necessary to have 10 - 80 liters of water flowing from the fully open tap in one minute to have your machine run smoothly. Attach a pressure reducing valve if water pressure is higher.

Open the taps completely after making the hose connection to check for water leaks at the connection points. If any leaks occur, turn off the tap and remove the nut. Retighten the nut carefully after checking the seal. To prevent water leakages and damages caused by them, keep the taps closed when the machine is not in use.

3.5 Connecting to the drain

- The end of the drain hose must be directly connected to the wastewater drain or to the washbasin.
- Drain hose shall be attached to a wall drain, stand pipe or sink siphon connected to the foul water drain, do not connect to surface water drains.



WARNING: Models with a single water inlet should not be connected to the hot water tap. In such a case the laundry will get damaged or the product will switch to protection mode and will not operate.

WARNING: Do not use old or used water inlet hoses on the new product. It may cause stains on your laundry.



WARNING: Your house will be flooded if the hose comes out of its housing during water discharge. Moreover, there is risk of scalding due to high washing temperatures! To prevent such situations and to ensure smooth water intake and discharge of the machine, fix the end of the discharge hose tightly so that it cannot come out.

Installation

- The hose should be attached to a height of at least 40 cm, and 100 cm at most.
- In case the hose is elevated after laying it on the floor level or close to the ground (less than 40 cm above the ground), water discharge becomes more difficult and the laundry may come out excessively wet. Therefore, follow the heights described in the figure.

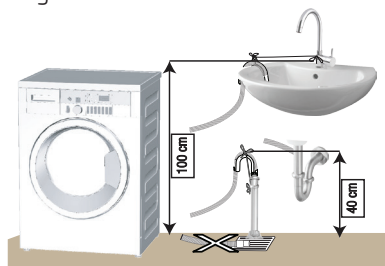

- To prevent flowing of dirty water back into the machine and to allow for easy discharge, do not immerse the hose end into the dirty water or do not drive it in the drain more than 15 cm. If it is too long, cut it short.
- The end of the hose should not be bent, it should not be stepped on and the hose must not be pinched between the drain and the machine.
- If the length of the hose is too short, use it by adding an original extension hose. Length of the hose may not be longer than 3.2 m. To avoid water leak failures, the connection between the extension hose and the drain hose of the product must be fitted well with an appropriate clamp as not to come off and leak.

3.6 Adjusting the feet



WARNING: In order to ensure that the product operates more silently and vibration-free, it must stand level and balanced on its feet. Balance the machine by adjusting the feet. Otherwise, the product may move from its place and cause crushing and vibration problems.

1. Loosen the lock nuts on the feet by hand.



2. Adjust the feet until the product stands level and balanced.

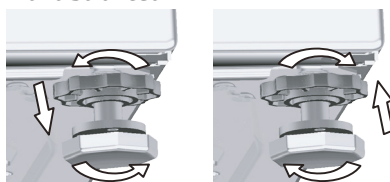

3. Tighten all lock nuts again by hand.



WARNING: Do not use any tools to loosen the lock nuts. Otherwise, they will get damaged.

3.7 Electrical connection

Connect the product to a grounded outlet protected by a 13 A fuse. Our company shall not be liable for any damages that will arise when the product is used without grounding in accordance with the local regulations.

- Connection must comply with national regulations.
- Power cable plug must be within easy reach after installation.
- If the current value of the fuse or breaker in the house is less than 13 Amps, have a qualified electrician install a 13 Amp fuse.
- The voltage specified in the "Technical specifications" section must be equal to your mains voltage.
- Do not make connections via extension cables or multi-plugs.

Installation



WARNING: Damaged power cables must be replaced by the Authorised Service Agents.

Electrical requirements

Before you insert the plug into the wall socket make sure that the voltage and the frequency shown in the rating label corresponds to your electricity supply.

We recommend that this appliance be connected to the mains supply via a suitable switched and fused socket in a readily accessible position.

Should the mains lead of the appliance become damaged or need replacing at any time, it must be replaced by a special purpose made mains lead which can only be obtained from a Authorised Service Agent.



WARNING: This appliance must be earthed.

If the fitted moulded plug is not suitable for your socket, then the plug should be cut off and an appropriate plug fitted.

Destroy the old plug, which is cut off as a plug with a bared cord could cause a shock hazard if inserted into a socket elsewhere in the house.

The moulded plug on this appliance incorporates a 13A fuse. Should the fuse need to be replaced an ASTA approved BS1362 fuse of the same rating must be used. Do not forget to refit the fuse cover. In the event of losing the fuse cover, the plug must not be used until a replacement fuse cover has been fitted.

Colour of the replacement fuse cover must be the same colour as that visible on the pin face of the plug. Fuse covers are available from any good electrical store.

Important

Fitting a different plug

As the colours of the wires in the mains lead of this appliance may not correspond with the coloured markings identifying the terminals on your plug, proceed as follows:

- 1 Connect the green - yellow or green (earth) wire to the terminal in the plug marked 'E' or with the symbol  or coloured green and yellow or green.
- 2 Connect the blue (neutral) wire to the terminal in the plug marked 'N' or coloured black.
- 3 Connect the brown (live) wire to the terminal in the plug marked 'L' or coloured red.

With the alternative plugs a 13A fuse must be fitted either in the plug or adaptor or in the main fuse box. If in doubt contact a qualified electrician.

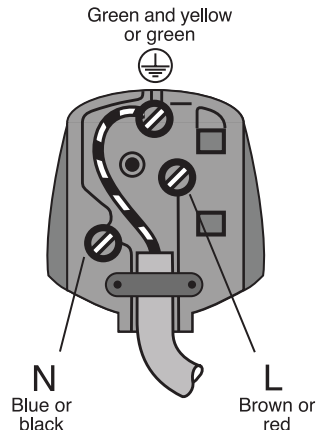

Transportation of the product

1. Unplug the product before transporting it.
2. Remove water drain and water supply connections.
3. Drain all water that has remained in the product. See 6.5
4. Install transportation safety bolts in the reverse order of removal procedure; see 3.3.



Never move the product without the transportation safety bolts properly fixed in place!











































WARNING: Packaging materials are dangerous to children. Keep packaging materials in a safe place away from reach of the children.

4 Preparation

4.1 Sorting the laundry

- Sort laundry according to type of fabric, colour, and degree of soiling and allowable water temperature.
- Always obey the instructions given on the garment tags.

LAUNDRY WASH SYMBOLS												
 Machine Wash Symbols	 Normal wash		 No Iron		 Sensitive-Delicate wash		 Hand wash		 Not washable		 No Spin	
	WASH Water Temperatures	Maximum Symbol(s)	95°C 	70°C 	60°C 	50°C 	40°C 	30°C 				
 Drying Symbols	 Suitable for dryer		 No Iron		 Sensitive / Delicate dry		 Do not dry with dryer		 Do not dry		 Do not dry-clean	
	DRYING Drying Settings	 At any temperature	 At high temperature	 At medium temperature	 At low temperature	 Without heating	 Hang to dry	 Lay to dry	 Hang wet to dry	 Lay in shadow to dry	 Dry-cleanable	
 IRON	Iron -		 Iron at high temperature		 Iron at medium temperature		 Iron at low temperature		 Do not iron		 Iron without steam	
	Dry or Steam		200 °C		150 °C		110 °C					
	Maximum temperature											
 BLEACH	 All bleaches are allowed				 Bleach (sodium hypochlorite) can be used		 Bleach is not allowed		 Only bleaches without chlorine are allowed			

4.2 Preparing laundry for washing

- Laundry items with metal attachments such as, underwired bras, belt buckles or metal buttons will damage the machine. Remove the metal pieces or wash the clothes by putting them in a laundry bag or pillow case.
- Take out all substances in the pockets such as coins, pens and paper clips, and turn pockets inside out and brush. Such objects may damage the product or cause noise problem.
- Put small size clothes such as infant's socks and nylon stockings in a laundry bag or pillow case.
- Place curtains in without compressing them. Remove curtain attachment items.
- Fasten zippers, sew loose buttons and mend rips and tears.
- Wash "machine washable" or "hand washable" labeled products only with an appropriate programme.
- Do not wash colours and whites together. New, dark coloured cottons release a lot of dye. Wash them separately.
- Tough stains must be treated properly before washing. If unsure, check with a dry cleaner.
- Use only dyes/colour changers and limescale removers suitable for machine wash. Always follow the instructions on the package.
- Wash trousers and delicate laundry turned inside out.
- Keep laundry items made of Angora wool in the freezer for a few hours before washing. This will reduce pilling.
- Laundry that are subjected to materials such as flour, lime dust, milk powder, etc. intensely must be shaken off before placing into the machine. Such dusts and powders on the laundry may build up on the inner parts of the machine in time and can cause damage.

4.3 Things to be done for energy saving

Following information will help you use the product in an ecological and energy-efficient manner.

- Operate the product in the highest capacity allowed by the programme you have selected, but do not overload; see, "Programme and consumption table".
- Always follow the instructions on the detergent packaging.
- Wash slightly soiled laundry at low temperatures.
- Use faster programmes for small quantities of lightly soiled laundry.
- Do not use prewash and high temperatures for laundry that is not heavily soiled or stained.
- If you plan to dry your laundry in a dryer, select the highest spin speed recommended during washing process.
- Do not use detergent in excess of the amount recommended on the detergent package.

4.4 Initial use

Before starting to use the product, make sure that all preparations are made in accordance with the instructions in sections "Important safety instructions" and "Installation". To prepare the product for washing laundry, perform first operation in Drum Cleaning programme. If your product is not equipped with Drum Cleaning programme, perform the Initial Use procedure in accordance with the methods described under "6.2 Cleaning the loading door and the drum" section of the user manual.

Preparation



Use an anti-limescale suitable for the washing machines.



Some water might have remained in the product due to the quality control processes in the production. It is not harmful for the product.

4.5 Correct load capacity

The maximum load capacity depends on the type of laundry, the degree of soiling and the washing programme desired.

The machine automatically adjusts the amount of water according to the weight of the loaded laundry.



WARNING: Follow the information in the "Programme and consumption table". When overloaded, machine's washing performance will drop. Moreover, noise and vibration problems may occur.

Laundry type	Weight (g)
Bathrobe	1200
Napkin	100
Duvet cover	700
Bed Sheet	500
Pillowcase	200
Tablecloth	250
Towel	200
Hand towel	100
Evening gown	200
Underclothing	100
Men's overalls	600
Men's shirt	200
Men's pajamas	500
Blouses	100

4.6 Loading the laundry

1. Open the loading door.
2. Place laundry items loosely into the machine.
3. Push the loading door to close until you hear a locking sound. Ensure that no items are caught in the door.



The loading door is locked while a programme is running. The door can only be opened a while after the programme comes to an end.



WARNING: In case of misplacing the laundry, noise and vibration problems may occur in the machine.

4.7 Using detergent and softener



When using detergent, softener, starch, fabric dye, bleach or limescale remover read the manufacturer's instructions on the package carefully and follow the suggested dosage values. Use measuring cup if available.

Detergent Drawer

Detergent drawer of your washing machine consists of four different compartments for powder main wash detergent, liquid main wash detergent, liquid softener and powder pre-wash detergent. Each of these laundry additives are dispensed automatically in the

Preparation

relevant time during the washing Programme. Do not place the laundry additives directly into the drum. Always use the detergent drawer. Do not close the drawer too fast after putting the laundry additives. This may cause the additives be dispensed early, creating unsatisfactory washing results and fabric damage.



Do not open the drawer during washing Programme.

The detergent drawer compartments are indicated below:

- 1) Left compartment with number "II" (Main wash compartment for powder detergent or powder bleach/stain remover)
- 2) Left compartment with number "II" and a water drop symbol (Main wash compartment for liquid detergent or liquid stain remover)
- 3) Middle compartment with number "I" (pre-wash compartment for powder detergent, powder stain remover or liquid bleach - liquid bleach must be added either during the pre-wash or during the first rinsing step of the washing Programme). Liquid bleach must be added manually while the machine takes in water.
- 4) Right compartment with "✳" symbol (liquid softener compartment)

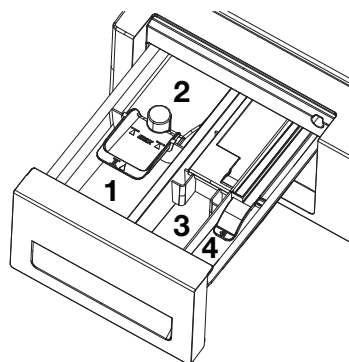

(II) Main Wash Compartment

Before starting the washing Programme, put powder detergent into the left compartment with number "II". Use the detergent manufacturer's measuring cup and follow the instructions on the package. Powder bleach/stain remover must also be put into this compartment.

Put the liquid detergent into the main wash compartment with number "II" and a water drop symbol before starting the washing Programme. Liquid stain remover must be put into this compartment. Put the suggested amount of liquid detergent into the left compartment with "II" and a water drop symbol and dilute it to the maximum filling level line (max. II and a water drop symbol) with warm water.

Particularly the concentrated detergents must be diluted with warm water; otherwise, the siphon may get clogged in time.

Do not fill the detergent above the maximum filling level line; otherwise the excess amount of detergent will reach the laundry without water and may cause stains on the garments. In this case you will need to refill the compartment. Do not pour the detergent onto the laundry directly since this may cause stains on the garments.

Liquid Softener Compartment

Put the suggested amount of liquid softener into the right compartment with "✳" symbol and dilute it to the maximum filling level line (max. ✳) with warm water.

Particularly the concentrated softeners must be diluted with warm water; otherwise, the siphon may get clogged in time.

Do not fill the softener above the maximum filling level line; otherwise the excess amount of softener will get mixed with the washing water and you will need to refill the compartment. Do not pour the softener onto the laundry directly since this may cause stains on the garments.

Preparation

Liquid softener will be dispensed automatically at the final rinsing step of the washing Programme.

(I) Pre-Wash Compartment

Put the powder pre-wash detergent or powder stain remover into the middle compartment with number "I".

You can also put liquid bleach into this compartment while the machine takes in water during pre-wash or first rinsing step. Adding the liquid bleach while the machine takes in water allows it to be diluted before it is poured onto the laundry.

You must select extra rinsing option if you use liquid bleach in a washing Programme. Bleach must be removed from the laundry with rinsing; otherwise it may cause itching on the skin.



Read the dosage instructions and label of your garments carefully before using the liquid bleach.

Starch

- Add liquid starch, powder starch or the dyestuff into the softener compartment as instructed on the package.
- Never use fabric softener and starch together in the same washing cycle.
- Wipe the inside of the drum after using starch.

Bleaches

If you are going to use regular bleach in your machine, it is suggested to select a Programme with pre-wash step and add the bleach at the beginning of the pre-wash without putting detergent into the pre-wash compartment. Alternatively, it is suggested to select a Programme with extra rinsing and add the bleach while the machine takes in water from the detergent drawer in the first rinsing step. Bleach should not be mixed with detergent. Since the bleach may cause irritation on skin, little amounts must be used and rinsed thoroughly. Do not pour bleach directly onto the laundry and do not use it with colour laundry.

When using oxygen based bleach, follow the instructions on the package and select a Programme at low temperature. Oxygen based bleach can be used together with the detergent. However, if it is not at the same thickness with the detergent, then it must be added from the compartment number "II" right after the detergent foams with water.

Eliminating lime formation

- When required, use only appropriate lime removers developed specifically for washing machines and always follow the instructions on the package.

Preparation

4.8 Tips for efficient washing

		Clothes			
		Light colours and whites	Colours	Dark colours	Delicates/Woolens/Silks
		(Recommended temperature range based on soiling level: 40-90°C)	(Recommended temperature range based on soiling level: cold-40°C)	(Recommended temperature range based on soiling level: cold-40°C)	(Recommended temperature range based on soiling level: cold-30°C)
Soiling Level	Heavily Soiled (difficult stains such as grass, coffee, fruits and blood.)	It may be necessary to pre-treat the stains or perform prewash. Powder and liquid detergents recommended for whites can be used at dosages recommended for heavily soiled clothes. It is recommended to use powder detergents to clean clay and soil stains and the stains that are sensitive to bleaches.	Powder and liquid detergents recommended for colours can be used at dosages recommended for heavily soiled clothes. It is recommended to use powder detergents to clean clay and soil stains and the stains that are sensitive to bleaches. Use detergents without bleach.	Liquid detergents suitable for colours and dark colours can be used at dosages recommended for heavily soiled clothes.	Prefer liquid detergents produced for delicate clothes. Woolen and silk clothes must be washed with special woolen detergents.
	Normally Soiled (For example, stains caused by body on collars and cuffs)	Powder and liquid detergents recommended for whites can be used at dosages recommended for normally soiled clothes.	Powder and liquid detergents recommended for colours can be used at dosages recommended for normally soiled clothes. Use detergents without bleach.	Liquid detergents suitable for colours and dark colours can be used at dosages recommended for normally soiled clothes.	Prefer liquid detergents produced for delicate clothes. Woolen and silk clothes must be washed with special woolen detergents.
	Lightly Soiled (No visible stains exist.)	Powder and liquid detergents recommended for whites can be used at dosages recommended for lightly soiled clothes.	Powder and liquid detergents recommended for colours can be used at dosages recommended for lightly soiled clothes. Use detergents without bleach.	Liquid detergents suitable for colours and dark colours can be used at dosages recommended for lightly soiled clothes.	Prefer liquid detergents produced for delicate clothes. Woolen and silk clothes must be washed with special woolen detergents.

5 Operating the product

5.1 Control panel

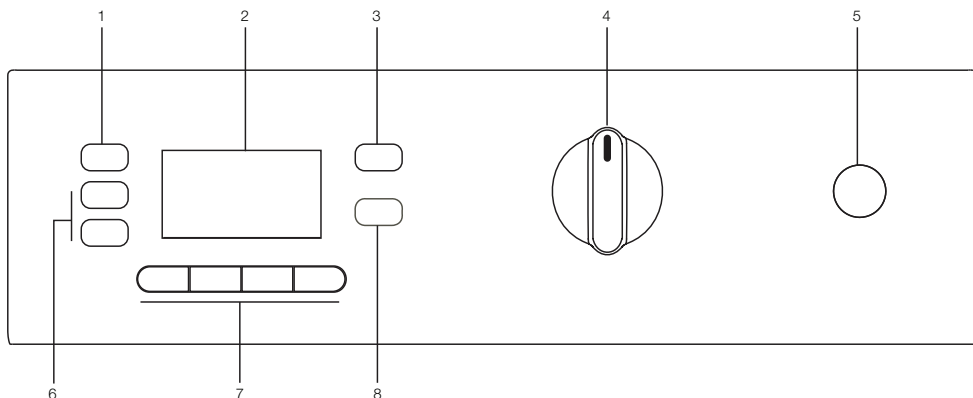

- | | | | |
|-----|-------------------------------|-----|-------------------------------|
| 1 - | Spin Speed Adjustment button | 5 - | On / Off button |
| 2 - | Display | 6 - | Delayed Start buttons (+ / -) |
| 3 - | Temperature Adjustment button | 7 - | Auxiliary Function buttons |
| 4 - | Programme Selection knob | 8 - | Start / Pause / Cancel button |

5.2 Display symbols

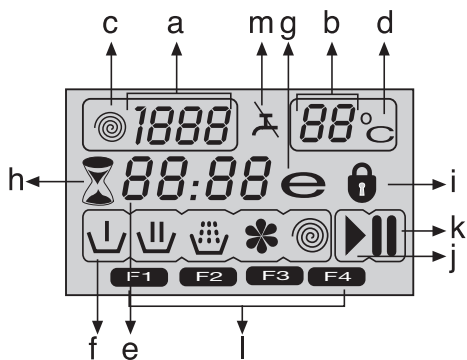

- | | |
|-----|---|
| a - | Spin Speed indicator |
| b - | Temperature indicator |
| c - | Spin symbol |
| d - | Temperature symbol |
| e - | Remaining Time and Delayed Start indicator |
| f - | Programme Indicator symbols (Prewash / Main Wash / Rinse / Softener / Spin) |
| g - | Economy symbol |
| h - | Delayed Start symbol |
| i - | Door Locked symbol |
| j - | Start symbol |
| k - | Pause symbol |
| l - | Auxiliary Function symbols |
| m - | No Water symbol |

Operating the product

5.3 Preparing the machine





1. Make sure that the hoses are connected tightly.
2. Plug in your machine.
3. Turn the tap on completely.
4. Place the laundry in the machine.
5. Add detergent and fabric softener.

5.4 Programme selection

1. Select the programme suitable for the type, quantity and soiling degree of the laundry in accordance with the "Programme and consumption table" and the temperature table below.

90°C	Heavily soiled white cottons and linens. (coffee table covers, tableclothes, towels, bed sheets, etc.)
60°C	Normally soiled, coloured, fade proof linens, cottons or synthetic clothes (shirt, nightgown, pyjamas, etc.) and lightly soiled white linens (underwear, etc.)
40°C- 30°C- Cold	Blended laundry including delicate textile (veil curtains, etc.), synthetics and woollens.

2. Select the desired programme with the Programme Selection button.

	Programmes are limited with the highest spin speed appropriate for that particular type of fabric.
	When selecting a programme, always consider the type of fabric, colour, degree of soiling and permissible water temperature.
	Always select the lowest required temperature. Higher temperature means higher power consumption.
	For further programme details, see "Programme and consumption table"

5.5 Main programmes

Depending on the type of fabric, use the following main programmes.

• Cottons

Use this programme for your cotton laundry (such as bed sheets, duvet and pillowcase sets, towels, bathrobes, underwear, etc.). Your laundry will be washed with vigorous washing action for a longer washing cycle.

• Synthetics

Use this programme to wash your synthetic clothes (shirts, blouses, synthetic/cotton blends, etc.). It washes with a gentle action and has a shorter washing cycle compared to the Cottons programme. For curtains and tulle, use the Synthetic 40°C programme with prewash and anti-creasing functions selected. As their meshed texture causes excessive foaming, wash the veils/tulle by putting little amount of detergent into the main wash compartment. Do not put detergent in the prewash compartment.

• Woollens

Use this programme to wash your woollen clothes. Select the appropriate temperature complying with the tags of your clothes. Use appropriate detergents for woollens.

Operating the product

5.6 Additional programmes

For special cases, additional programmes are available in the machine.



Additional programmes may differ according to the model of the machine.

• Cottons Eco

You may wash your normally soiled durable cotton and linen laundry in this programme with the highest energy and water saving compared to all other wash programmes suitable for cottons. Actual water temperature may differ from the declared cycle temperature. Programme duration may automatically be shortened during later stages of the programme if you wash less amount (e.g. ½ capacity or less) of laundry. In this case energy and water consumption will be further decreased giving you the opportunity for a more economical wash. This feature is available for certain models having remaining time display.

• BabyClothing

Use this programme to wash baby laundry, and the laundry that belongs to allergic persons. Longer heating time and an additional rinsing step provide a higher level of hygiene.

• Hand wash

Use this programme to wash your woollen/delicate clothes that bear “not machine-washable” tags and for which hand wash is recommended. It washes laundry with a very gentle washing action to not to damage clothes.

• Daily Quick

Use this programme to wash your lightly soiled cotton clothes in a short time.

• Super Short

Use this programme to wash your little amount of lightly soiled cotton clothes in a short time.

• Dark Care

Use this programme to wash your dark coloured laundry, or the coloured laundry that you do not want them get faded. Washing is performed with less mechanical movements at low temperature. It is recommended to use liquid detergent or wool shampoo for dark coloured laundry.

• Mixed Fabrics

Use this programme to wash your cotton and synthetic clothes together without sorting them.

• Shirts

Use this programme to wash the shirts made of cotton, synthetic and synthetic blended fabrics together.

• Freshen Up

Use this programme to remove the odour on the laundry that are worn only for once and do not contain any stains or dirt.

• Eco Clean 20

Use this programme, which is much more sensitive to environment and natural resources, to wash your lightly soiled and unstained cotton laundry (max. 3.5 kg) in a short time and economically.



It is recommended to use liquid detergent or gel washing detergent.

• Self Clean

Use this programme regularly (once in every 1-2 months) to clean the drum and provide the required hygiene. Run the programme without any laundry in the machine. To obtain better results, put powder limescale remover for washing machines into the detergent compartment II. When the programme is over, leave the loading door ajar so that the inside of the machine gets dry.



This is not a washing programme. It is a maintenance programme.

Operating the product



Do not run the programme when there is something in the machine. If you try to do so, the machine detects that there is a load inside and aborts the programme

5.7 Special programmes

For specific applications, select any of the following programmes.

• Rinse

Use this programme when you want to rinse or starch separately.

• Spin+Drain

Use this programme to apply an additional spin cycle for your laundry or to drain the water in the machine.

Before selecting this programme, select the desired spin speed and press Start / Pause / Cancel button. The machine will spin the laundry with the set spin speed and drain the water coming out of them.

If you wish to drain only the water without spinning your laundry, select the Pump+Spin programme and then select the No Spin function with the help of Spin Speed Adjustment button. Press Start / Pause / Cancel button.



Use a lower spin speed for delicate laundries.

5.8 Temperature selection

Whenever a new programme is selected, the maximum temperature for the selected programme appears on the temperature indicator.

To decrease the temperature, press the Temperature Adjustment button. Temperature decreases with increments of 10° and finally, “-” symbol indicating the cold wash option appears on the display.

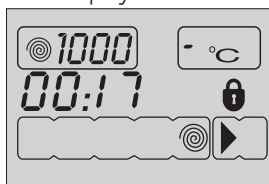

If you scroll to cold wash option and press Temperature Adjustment button again, the recommended temperature for the selected programme appears on the display. Press the Temperature Adjustment button again to decrease the temperature.

Economy symbol

Indicates the programmes and temperatures that provide energy savings.



Economy symbol can not be selected in Intensive and Hygiene programmes since washing is performed in long times and at high temperatures in order to provide hygiene. Similarly, Economy symbol can not be selected in Baby, Refresh, Drum Cleaning, Spin and Rinse programmes as well.



5.9 Spin speed selection

Whenever a new programme is selected, the recommended spin speed of the selected programme is displayed on the spin speed indicator.

To decrease the spin speed, press the Spin Speed Adjustment button. Spin speed decreases gradually. Then, depending on the model of the product, "Rinse Hold" and "No Spin" options appear on the display. See "Auxiliary function selection" section for explanations of these options.

Rinse Hold

If you are not going to unload your clothes immediately after the programme completes, you may use rinse hold function to keep your laundry in the final rinsing water in order to prevent them from getting wrinkled when there is no water in the machine. Press Start / Pause / Cancel button after this process if you want to drain the water without spinning your laundry. Programme will resume and complete after draining the water.

If you want to spin the laundry held in water, adjust the Spin Speed and press Start / Pause / Cancel button.

The programme resumes. Water is drained, laundry is spun and the programme is completed.



Rinse Hold option is indicated with "LJ" symbol and No Spin option is indicated with "--" symbol.

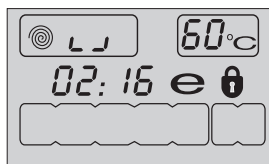

Operating the product

5.10 Programme and consumption table

EN	Programme (°C)	Max. Load (kg)	Water Consumption (l)	Energy Consumption (kWh)	Max. Speed***	Auxiliary functions				Selectable temperature range °C
						Prewash	Quicker Wash	Extra Rinse	Anti-Crease	
Cottons	90	7	80	2.10	1400	•	•	•	•	90-Cold
	60	7	77	1.55	1400	•	•	•	•	90-Cold
	40	7	77	1.00	1400	•	•	•	•	90-Cold
BabyClothing	90	7	70	2.00	1400			*		90-30
Cottons Eco	60**	7	44	1.00	1400					60-Cold
	60**	3.5	38	0.84	1400					60-Cold
	40**	3.5	38	0.65	1400					60-Cold
	40	7	60	0.84	1400					60-Cold
Synthetics	60	3	51	1.00	1200	•	•	•	•	60-Cold
	40	3	51	0.70	1200	•	•	•	•	60-Cold
Eco Clean 20	20	3.5	35	0.16	1400					20
Mixed Fabrics	40	3	45	0.50	1200	•	•	•	•	40-Cold
Shirts	40	3	45	0.50	800	•	•	•	*	60-Cold
Super Short	30	2	35	0.10	1400			•		30-Cold
Daily Quick	90	7	60	1.80	1400			•		90-Cold
	60	7	60	1.00	1400			•		90-Cold
	30	7	70	0.20	1400			•		90-Cold
Woollens	40	1.5	42	0.20	1200			•		40-Cold
Hand Wash	30	1	30	0.15	1200					30-Cold
Dark Care	40	3	65	0.55	1200			*		40-Cold
Self Clean	70	-	90	1.70	800			*		70
Freshen Up	-	2	20	0.03	1200					-

• : Selectable

* : Automatically selected, no cancelling.

** : Energy Label programme (EN 60456 Ed.3)

*** If maximum spin speed of the machine is lower then this value, you can only select up to the maximum spin speed.

- : See the programme description for maximum load.

Operating the product

 ** "Cotton eco 40°C and Cotton eco 60°C are standard cycles." These cycles are known as '40°C cotton standard cycle' and '60°C cotton standard cycle' and indicated with the   symbols on the panel.



The auxiliary functions in the table may vary according to the model of your machine.



Water and power consumption may vary subject to the changes in water pressure, water hardness and temperature, ambient temperature, type and amount of laundry, selection of auxiliary functions and spin speed, and changes in electric voltage.



You can see the washing time of the programme you have selected on the display of the machine. It is normal that small differences may occur between the time shown on the display and the real washing time.



"Selectability of auxiliary functions might be changed by the manufacturer. New selectabilities might be added or existing ones might be removed."
"The spin speed of your machine may vary among the programmes, however this speed cannot exceed the max. spin speed of your machine."

Indicative values for Synthetics programmes (EN)

	Load (kg)	Water Consumption (l)	Energy Consumption (kWh)	Programme Duration (min)*	Remaining Moisture Content (%) ** ≤ 1000 rpm	Remaining Moisture Content (%) ** > 1000 rpm
Synthetics 60	3	51	1.00	90'/120'	45	40
Synthetics 40	3	51	0.70	90'/120'	45	40

* You can see the washing time of the programme you have selected on the display of the machine. It is normal that small differences may occur between the time shown on the display and the real washing time.

** Remaining moisture content values may differ according to the selected spin speed.

Operating the product

5.11 Auxiliary function selection

Select the desired auxiliary functions before starting the programme. Furthermore, you may also select or cancel auxiliary functions that are suitable to the running programme by pressing the Start / Pause / Cancel button when the machine is operating. For this, the machine must be in a step before the auxiliary function you are going to select or cancel. Depending on the programme, press a, b, c or d buttons to select the desired auxiliary function. Symbol of the selected auxiliary function appears on the display.

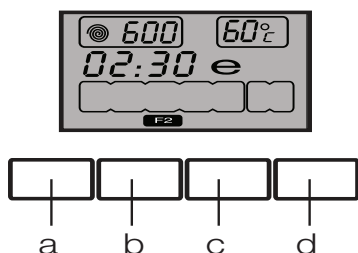

F1 appears on the display when you select this function (a).

• Quicker Wash

This function can be used in Cottons and Synthetics programmes. It decreases the washing times and also the number of rinsing steps for lightly soiled laundry.

F2 appears on the display when you select this function (b).



When you select this function, load your machine with half of the maximum laundry specified in the programme table.

• Extra Rinse

This function enables the machine to make another rinsing in addition to the one already made after the main wash. Thus, the risk for sensitive skins (babies, allergic skins, etc.) to be effected by the minimal detergent remnants on the laundry can be reduced.

F3 appears on the display when you select this function (c).

• Anti-Crease

This function creases the clothes lesser when they are being washed. Drum movement is reduced and spinning speed is limited to prevent creasing. In addition, washing is done with a higher water level.

F4 appears on the display when you select this function (d).



Some functions cannot be selected together. If a second auxiliary function conflicting with the first one is selected before starting the machine, the function selected first will be cancelled and the second auxiliary function selection will remain active. For example, if you want to select Quick Wash after you have selected the Prewash, Prewash will be cancelled and Quick Wash will remain active.



An auxiliary function that is not compatible with the programme cannot be selected. (See "Programme and consumption table")



Auxiliary Function buttons may vary according to the model of the machine.

• Prewash

A Prewash is only worthwhile for heavily soiled laundry. Not using the Prewash will save energy, water, detergent and time.

5.12 Time display

Remaining time to complete the programme appears on the display while the programme is running. Tim is displayed as "01:30" in hours and minutes format.

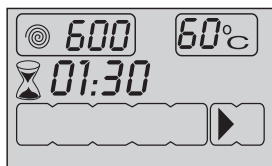

Programme time may differ from the values in the "Programme and consumption table" depending on the water pressure, water hardness and temperature, ambient temperature, amount and the type of laundry, auxiliary functions selected and the changes at the mains voltage.

Delayed start

With the Delayed Start function the startup of the programme may be delayed up to 24 hours. Delayed start time can be increased by increments of 30 minutes.



Do not use liquid detergents when you set Delayed Start! There is the risk of staining of the clothes.

1. Open the loading door, place the laundry and put detergent, etc.
2. Select the washing programme, temperature, spin speed and, if required, the auxiliary functions.
3. Set the desired delayed start time by pressing the Delayed Start + or - buttons. Delayed Start symbol flashes.
4. Press Start / Pause / Cancel button. Delayed start countdown starts. Delayed Start symbol illuminates steadily. Start symbol appears. ":" sign in the middle of the delayed start time on the display starts flashing.



Additional laundry may be loaded during the delayed start period. At the end of the countdown, Delayed Start symbol disappears, washing cycle starts and the time of the selected programme appears on the display.

Changing the delayed start period

If you want to change the time during countdown:

1. Press Start / Pause / Cancel button. ":" sign in the middle of the delayed start time on the display stops flashing. Pause symbol appears. Delayed Start symbol flashes. Start symbol disappears.
2. Set the desired delayed start time by pressing the Delayed Start + or - buttons.
3. Press Start / Pause / Cancel button. Delayed Start symbol illuminates steadily. Pause symbol disappears. Start symbol appears.
4. ":" sign in the middle of the delayed start time on the display starts flashing.

Cancelling the Delayed Start function

If you want to cancel the delayed start countdown and start the programme immediately:

1. Press Start / Pause / Cancel button. ":" sign in the middle of the delayed start time on the display stops flashing.
2. Start symbol disappears. Pause symbol and Delayed Start symbol flashes.
3. Decrease the delayed start time by pressing the Delayed Start - button. Programme duration appears after 30 minutes.
4. Press Start / Pause / Cancel button to start the programme.

Operating the product

5.13 Starting the programme

1. Press Start / Pause / Cancel button to start the programme.
2. Start symbol showing the startup of the programme will turn on.
3. Loading door is locked and Door Locked symbol appears on the display.
4. The symbol of the step from which the programme has started appears on the display (Prewash, Main Wash, Rinse, Softener and Spin).

5.14 Progress of programme

Progress of a running programme is indicated on the display with a set of symbols. Relevant symbol appears on the display at the beginning of each programme step and all symbols remain lit at the end of the programme. The farthestmost right symbol indicates the current programme step.

Prewash

If the Prewash auxiliary function is selected, Prewash symbol appears on the display indicating that the prewash step has started.

Main Wash

Main Wash symbol indicating that the main wash step has started appears on the display.

Rinse

Rinse symbol indicating that the rinsing step has started appears on the display.

Softener

Softener symbol indicating that the softener step has started appears on the display.

Spin

Appears at the beginning of the final spin step and remains lit during Spin and Pump special programmes.



If the machine does not pass to the spinning step, Rinse Hold function might be active or the automatic unbalanced load detection system might be activated due to the unbalanced distribution of the laundry in the machine.

5.15 Loading door lock

There is a locking system on the loading door of the machine that prevents opening of the door in cases when the water level is unsuitable.

Door Locked symbol appears when the loading door is locked. This symbol will flash until the loading door becomes ready to open when programme completes or the machine is paused. Do not force to open the loading door in this step. Symbol disappears when the door is ready to open. You can open the door when the symbol disappears.

5.16 Changing the selections after programme has started

Switching the machine to pause mode

Press the Start / Pause / Cancel button to switch the machine to pause mode. Pause symbol appears on the display indicating that the machine is paused. Start symbol disappears.

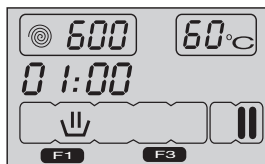

Changing the speed and temperature settings for auxiliary functions

Depending on the step the programme has reached, you may cancel or activate the auxiliary functions; see, "Auxiliary function selection".

You may also change the speed and temperature settings; see, "Spin speed selection" and "Temperature selection".

Adding or taking out laundry

1. Press the Start / Pause / Cancel button to switch the machine to pause mode. The programme follow-up light of the relevant step during which the machine was switched into the pause mode will flash.

Operating the product

2. Wait until the Loading Door can be opened.
3. Open the Loading Door and add or take out the laundry.
4. Close the Loading Door.
5. Make changes in auxiliary functions, temperature and speed settings if necessary.
6. Press Start / Pause / Cancel button to start the machine.



The loading door will not open if the water temperature in the machine is high or the water level is above the door opening.

5.17 Child Lock

Use Child Lock function to prevent children from tampering with the machine. Thus you can avoid any changes in a running programme.



You can switch on and off the machine with On / Off button when the Child Lock is active. When you switch on the machine again, programme will resume from where it has stopped.

To activate the Child Lock:

Press and hold 2nd and 4th Auxiliary Function buttons for 3 seconds. "Con" appears on the display.

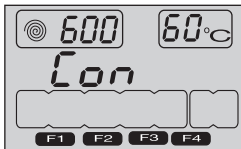

Same phrase will appear on the display if you press any button when Child Lock is enabled.

To deactivate the Child Lock:

Press and hold 2nd and 4th Auxiliary Function buttons for 3 seconds. "COFF" appears on the display.

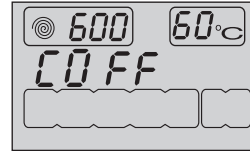

Do not forget to disable the child lock at the end of the programme if it was enabled before. Otherwise, machine will not allow to select a new programme.

5.18 Cancelling the programme

Press and hold Start / Pause / Cancel button for 3 seconds. Start symbol flashes. Symbol of the step at which the programme was cancelled remains lit. "End" appears on the display and the programme is cancelled.

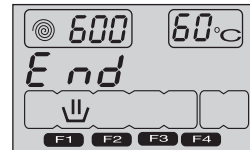

If you want to open the loading door after you have cancelled the programme but it is not possible to open the loading door since the water level in the machine is above the loading door opening, then turn the Programme Selection knob to Pump+Spin programme and discharge the water in the machine.

5.19 Machine is in Rinse Hold mode

Spin symbol flashes and Pause symbol illuminates when the machine is in Rinse Hold mode.

If you want to spin your laundry when the machine is in this mode:

Adjust the spin speed and press Start / Pause / Cancel button. Pause symbol disappears and Start symbol appears. Programme resumes, discharges the water and spins the laundry.

If you only want to drain the water without spinning:

Just press Start / Pause / Cancel button. Pause symbol disappears. Start symbol appears. Programme resumes and discharges the water only.

5.20 End of programme

"End" appears on the display at the end of the programme. Symbols of the programme steps remain lit. Auxiliary function, spin speed and temperature that were selected at the beginning of the programme remain selected.

5.21 Your machine is equipped with a "Standby Mode"

In case of not starting any programme or waiting without making any other operation when the machine is turned on by On/Off button and while it is in selection step or if no other operation is performed approximately 2 minutes after the programme you selected has come to an end, your machine will automatically switch to energy saving mode. Brightness of indicator lights will decrease. Also, if your product is equipped with a display showing the programme duration, this display will completely turn off. In case of rotating the Programme Selection knob or pressing any button, lights and display will restore to their previous condition. Your selections made while exiting the energy saving mode may change. Check the appropriateness of your selections before starting the programme. Readjust if necessary. This is not a fault.

6 Maintenance and cleaning

Service life of the product extends and frequently faced problems decrease if cleaned at regular intervals.

6.1 Cleaning the detergent drawer

Remove any powder residue buildup in the drawer. To do this;

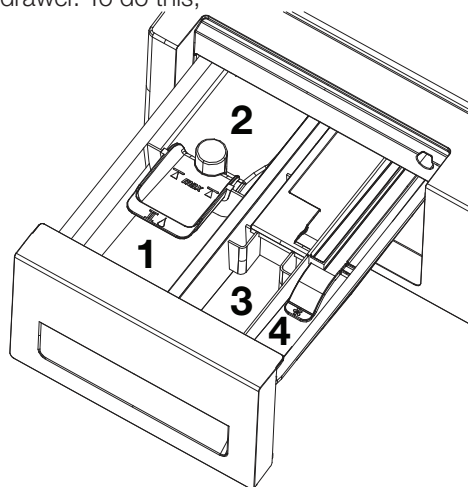

1. You can remove the detergent drawer by pulling it towards yourself strongly.



If more than a normal amount of softener and liquid detergent mixture starts to remain in the softener compartment, the siphon must be cleaned.

2. Wash the drawer and the siphon with plenty of lukewarm water in a washbasin. Wear protective gloves or use an appropriate brush to avoid touching the residues in the drawer when cleaning.
3. Replace the drawer into its housing after cleaning. Check if the siphon is in its original location.

6.2 Cleaning the loading door and the drum

Residues of softener, detergent and dirt may accumulate in your machine in time and may cause unpleasant odours and washing complaints. To avoid this, use the **Drum Cleaning** programme. If your machine is not featured with **Drum Cleaning** programme, use Cottons-90 programme and select **Additional Water** or **Extra Rinse** auxiliary functions as well. Run the Before starting the programme, put max. 100 g of powder anti-limescale into the main wash detergent compartment (compartment nr. 2). If the anti-limescale is in tablet form, put only one tablet into compartment nr. 2. Dry the inside of the bellow with a clean piece of cloth after the programme has come to an end.



Repeat Drum Cleaning process in every 2 months.



Use an anti-limescale suitable for the washing machines.

After every washing make sure that no foreign substance is left in the drum.



If the holes on the bellow shown in the figure is blocked, open the holes using a toothpick.



Foreign metal substances will cause rust stains in the drum. Clean the stains on the drum surface by using cleaning agents for stainless steel. Never use steel wool or wire wool.



WARNING: Never use sponge or scrub materials. These will damage the painted and plastic surfaces.

6.3 Cleaning the body and control panel

Wipe the body of the machine with soapy water or non-corrosive mild gel detergents as necessary, and dry with a soft cloth.

Use only a soft and damp cloth to clean the control panel.

6.4 Cleaning the water intake filters

There is a filter at the end of each water intake valve at the rear of the machine and also at the end of each water intake hose where they are connected to the tap. These filters prevent foreign substances and dirt in the water to enter the washing machine. Filters should be cleaned as they do get dirty.

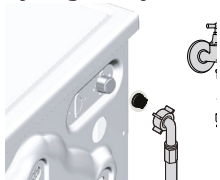

1. Close the taps.
2. Remove the nuts of the water intake hoses to access the filters on the water intake valves. Clean them with an appropriate brush. If the filters are too dirty, take them out by means of pliers and clean them.
3. Take out the filters on the flat ends of the water intake hoses together with the gaskets and clean thoroughly under running water.
4. Replace the gaskets and filters carefully in their places and tighten the hose nuts by hand.

6.5 Draining remaining water and cleaning the pump filter

The filter system in your machine prevents solid items such as buttons, coins and fabric fibers clogging the pump impeller during discharge of washing water. Thus, the water will be discharged without any problem and the service life of the pump will extend.

If the machine fails to drain water, the pump filter is clogged. Filter must be cleaned whenever it is clogged or in every 3 months. Water must be drained off first to clean the pump filter.

In addition, prior to transporting the machine (e.g., when moving to another house) and in case of freezing of the water, water may have to be drained completely.



WARNING: Foreign substances left in the pump filter may damage your machine or may cause noise problem.

In order to clean the dirty filter and discharge the water:

1. Unplug the machine to cut off the supply power.



WARNING: Temperature of the water inside the machine may rise up to 90 °C. To avoid burning risk, filter must be cleaned after the water in the machine cools down.

Maintenance and cleaning

2. Some of our products have emergency draining hose and some does not have. Follow the steps below to discharge the water.

Discharging the water when the product has an emergency draining hose:

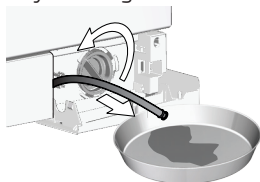

- a. Pull the emergency draining hose out from its seat
- b. Place a large container at the end of the hose. Drain the water into the container by pulling out the plug at the end of the hose. When the container is full, block the inlet of the hose by replacing the plug. After the container is emptied, repeat the above procedure to drain the water in the machine completely.
- c. When draining of water is finished, close the end by the plug again and fix the hose in its place.
- d. Turn the pump filter to take it out.
4. Clean any residues inside the filter as well as fibers, if any, around the pump impeller region.
5. Install the filter.
6. If the filter cap is composed of two pieces, close the filter cap by pressing on the tab. If it is one piece, seat the tabs in the lower part into their places first, and then press the upper part to close.

Problem	Reason	Solution
Programme does not start after closing the door.	Start / Pause / Cancel button was not pressed.	<ul style="list-style-type: none"> • *Press the Start / Pause / Cancel button.
Programme cannot be started or selected.	Washing machine has switched to self protection mode due to a supply problem (line voltage, water pressure, etc.).	<ul style="list-style-type: none"> • Press and hold Start / Pause / Cancel button for 3 seconds to reset the machine to factory settings. (see. "Cancellation of programme")
Water in the machine.	Some water might have remained in the product due to the quality control processes in the production.	<ul style="list-style-type: none"> • This is not a failure; water is not harmful to the machine.
Machine does not fill with water.	Tap is turned off.	<ul style="list-style-type: none"> • Turn on the taps.
	Water inlet hose is bent.	<ul style="list-style-type: none"> • Flatten the hose.
	Water inlet filter is clogged.	<ul style="list-style-type: none"> • Clean the filter.
	Loading door may be open.	<ul style="list-style-type: none"> • Close the door.
Machine does not drain water.	Water drain hose might be clogged or twisted.	<ul style="list-style-type: none"> • Clean or flatten the hose.
	Pump filter is clogged.	<ul style="list-style-type: none"> • Clean the pump filter.
Machine vibrates or makes noise.	Machine might be standing unbalanced.	<ul style="list-style-type: none"> • Adjust the feet to level the machine.
	A hard substance might have entered into the pump filter.	<ul style="list-style-type: none"> • Clean the pump filter.
	Transportation safety bolts are not removed.	<ul style="list-style-type: none"> • Remove the transportation safety bolts.
	Laundry quantity in the machine might be too little.	<ul style="list-style-type: none"> • Add more laundry to the machine.
	Machine might be overloaded with laundry.	<ul style="list-style-type: none"> • Take out some of the laundry from the machine or distribute the load by hand to balance it homogenously in the machine.
	Machine might be leaning on a rigid item.	<ul style="list-style-type: none"> • Make sure that the machine is not leaning on anything.
There is water leaking from the bottom of the washing machine.	Water drain hose might be clogged or twisted.	<ul style="list-style-type: none"> • Clean or flatten the hose.
	Pump filter is clogged.	<ul style="list-style-type: none"> • Clean the pump filter.
Machine stopped shortly after the programme started.	Machine might have stopped temporarily due to low voltage.	<ul style="list-style-type: none"> • It will resume running when the voltage restores to the normal level.
Machine directly discharges the water it takes in.	Draining hose might not be at adequate height.	<ul style="list-style-type: none"> • Connect the water draining hose as described in the operation manual.
No water can be seen in the machine during washing.	The water level is not visible from outside of the washing machine.	<ul style="list-style-type: none"> • This is not a failure.
Loading door cannot be opened.	Door lock is activated because of the water level in the machine.	<ul style="list-style-type: none"> • Drain the water by running the Pump or Spin programme.
	Machine is heating up the water or it is at the spinning cycle.	<ul style="list-style-type: none"> • Wait until the programme completes.
	Child lock is engaged. Door lock will be deactivated a couple of minutes after the programme has come to an end.	<ul style="list-style-type: none"> • Wait for a couple of minutes for deactivation of the door lock.

Troubleshooting

Problem	Reason	Solution
Washing takes longer time than specified in the manual. (*)	Water pressure is low.	<ul style="list-style-type: none"> Machine waits until taking in adequate amount of water to prevent poor washing quality due to the decreased amount of water. Therefore, the washing time extends.
	Voltage might be low.	<ul style="list-style-type: none"> Washing time is prolonged to avoid poor washing results when the supply voltage is low.
	Input temperature of water might be low.	<ul style="list-style-type: none"> Required time to heat up the water extends in cold seasons. Also, washing time can be lengthened to avoid poor washing results.
	Number of rinses and/or amount of rinse water might have increased.	<ul style="list-style-type: none"> Machine increases the amount of rinse water when good rinsing is needed and adds an extra rinsing step if necessary.
	Excessive foam might have occurred and automatic foam absorption system might have been activated due to too much detergent usage.	<ul style="list-style-type: none"> Use recommended amount of detergent.
Programme time does not countdown. (On models with display) (*)	Timer may stop during water intake.	<ul style="list-style-type: none"> Timer indicator will not countdown until the machine takes in adequate amount of water. The machine will wait until there is sufficient amount of water to avoid poor washing results due to lack of water. Timer indicator will resume countdown after this.
	Timer may stop during heating step.	<ul style="list-style-type: none"> Timer indicator will not countdown until the machine reaches the selected temperature.
	Timer may stop during spinning step.	<ul style="list-style-type: none"> Automatic unbalanced load detection system might be activated due to the unbalanced distribution of the laundry in the drum.
Programme time does not countdown. (*)	There might be unbalanced load in the machine.	<ul style="list-style-type: none"> Automatic unbalanced load detection system might be activated due to the unbalanced distribution of the laundry in the drum.
Machine does not switch to spinning step. (*)	There might be unbalanced load in the machine.	<ul style="list-style-type: none"> Automatic unbalanced load detection system might be activated due to the unbalanced distribution of the laundry in the drum.
	The machine will not spin if water is not drained completely.	<ul style="list-style-type: none"> Check the filter and the draining hose.
	Excessive foam might have occurred and automatic foam absorption system might have been activated due to too much detergent usage.	<ul style="list-style-type: none"> Use recommended amount of detergent.

Troubleshooting

Problem	Reason	Solution
Washing performance is poor: Laundry turns grey. (**)	Insufficient amount of detergent has been used over a long period of time.	<ul style="list-style-type: none"> Use the recommended amount of detergent appropriate for water hardness and the laundry.
	Washing was made at low temperatures for a long time.	<ul style="list-style-type: none"> Select the proper temperature for the laundry to be washed.
	Insufficient amount of detergent is used with hard water.	<ul style="list-style-type: none"> Using insufficient amount of detergent with hard water causes the soil to stick on the cloth and this turns the cloth into grey in time. It is difficult to eliminate greying once it happens. Use the recommended amount of detergent appropriate for water hardness and the laundry.
	Too much detergent is used.	<ul style="list-style-type: none"> Use the recommended amount of detergent appropriate for water hardness and the laundry.
Washing performance is poor: Stains persist or the laundry is not whitened. (**)	Insufficient amount of detergent is used.	<ul style="list-style-type: none"> Use the recommended amount of detergent appropriate for water hardness and the laundry.
	Excessive laundry was loaded in.	<ul style="list-style-type: none"> Do not load the machine in excess. Load with amounts recommended in the "Programme and consumption table".
	Wrong programme and temperature were selected.	<ul style="list-style-type: none"> Select the proper programme and temperature for the laundry to be washed.
	Wrong type of detergent is used.	<ul style="list-style-type: none"> Use original detergent appropriate for the machine.
	Too much detergent is used.	<ul style="list-style-type: none"> Put the detergent in the correct compartment. Do not mix the bleaching agent and the detergent with each other.
Washing performance is poor: Oily stains appeared on the laundry. (**)	Regular drum cleaning is not applied.	<ul style="list-style-type: none"> Clean the drum regularly. For this, please see 6.2.
Washing performance is poor: Clothes smell unpleasantly. (**)	Odours and bacteria layers are formed on the drum as a result of continuous washing at lower temperatures and/or in short programmes.	<ul style="list-style-type: none"> Leave the detergent drawer as well as the loading door of the machine ajar after each washing. Thus, a humid environment favorable for bacteria cannot occur in the machine.
Colour of the clothes faded. (**)	Excessive laundry was loaded in.	<ul style="list-style-type: none"> Do not load the machine in excess.
	Detergent in use is damp.	<ul style="list-style-type: none"> Keep detergents closed in an environment free of humidity and do not expose them to excessive temperatures.
	A higher temperature is selected.	<ul style="list-style-type: none"> Select the proper programme and temperature according to the type and soiling degree of the laundry.

Troubleshooting

Problem	Reason	Solution
It does not rinse well.	The amount, brand and storage conditions of the detergent used are inappropriate.	<ul style="list-style-type: none"> Use a detergent appropriate for the washing machine and your laundry. Keep detergents closed in an environment free of humidity and do not expose them to excessive temperatures.
	Detergent is put in the wrong compartment.	<ul style="list-style-type: none"> If detergent is put in the prewash compartment although prewash cycle is not selected, machine can take this detergent during rinsing or softener step. Put the detergent in the correct compartment.
	Pump filter is clogged.	<ul style="list-style-type: none"> Check the filter.
	Drain hose is folded.	<ul style="list-style-type: none"> Check the drain hose.
Laundry became stiff after washing. (**)	Insufficient amount of detergent is used.	<ul style="list-style-type: none"> Using insufficient amount of detergent for the water hardness can cause the laundry to become stiff in time. Use appropriate amount of detergent according to the water hardness.
	Detergent is put in the wrong compartment.	<ul style="list-style-type: none"> If detergent is put in the prewash compartment although prewash cycle is not selected, machine can take this detergent during rinsing or softener step. Put the detergent in the correct compartment.
	Detergent might be mixed with the softener.	<ul style="list-style-type: none"> Do not mix the softener with detergent. Wash and clean the dispenser with hot water.
Laundry does not smell like the softener. (**)	Detergent is put in the wrong compartment.	<ul style="list-style-type: none"> If detergent is put in the prewash compartment although prewash cycle is not selected, machine can take this detergent during rinsing or softener step. Wash and clean the dispenser with hot water. Put the detergent in the correct compartment.
	Detergent might be mixed with the softener.	<ul style="list-style-type: none"> Do not mix the softener with detergent. Wash and clean the dispenser with hot water.

Troubleshooting

Problem	Reason	Solution
Detergent residue in the detergent drawer. (**)	Detergent is put in wet drawer.	<ul style="list-style-type: none"> • Dry the detergent drawer before putting in detergent.
	Detergent has gotten damp.	<ul style="list-style-type: none"> • Keep detergents closed in an environment free of humidity and do not expose them to excessive temperatures.
	Water pressure is low.	<ul style="list-style-type: none"> • Check the water pressure.
	The detergent in the main wash compartment got wet while taking in the prewash water. Holes of the detergent compartment are blocked.	<ul style="list-style-type: none"> • Check the holes and clean if they are clogged.
	There is a problem with the detergent drawer valves.	<ul style="list-style-type: none"> • Call the Authorised Service Agent.
	Detergent might be mixed with the softener.	<ul style="list-style-type: none"> • Do not mix the softener with detergent. Wash and clean the dispenser with hot water.
	Regular drum cleaning is not applied.	<ul style="list-style-type: none"> • Clean the drum regularly. For this, please see 6.2.
Too much foam forms in the machine. (**)	Improper detergents for the washing machine are being used.	<ul style="list-style-type: none"> • Use detergents appropriate for the washing machine.
	Excessive amount of detergent is used.	<ul style="list-style-type: none"> • Use only sufficient amount of detergent.
	Detergent was stored under improper conditions.	<ul style="list-style-type: none"> • Store detergent in a closed and dry location. Do not store in excessively hot places.
	Some meshed laundry such as tulle may foam too much because of their texture.	<ul style="list-style-type: none"> • Use smaller amounts of detergent for this type of item.
	Detergent is put in the wrong compartment.	<ul style="list-style-type: none"> • Put the detergent in the correct compartment.
	Softener is being taken early.	<ul style="list-style-type: none"> • There may be problem in the valves or in the detergent dispenser. Call the Authorised Service Agent.
Foam is overflowing from the detergent drawer.	Too much detergent is used.	<ul style="list-style-type: none"> • Mix 1 tablespoonful softener and ½ l water and pour into the main wash compartment of the detergent drawer.
		<ul style="list-style-type: none"> • Put detergent into the machine suitable for the programmes and maximum loads indicated in the "Programme and consumption table". When you use additional chemicals (stain removers, bleachs and etc), reduce the amount of detergent.

Troubleshooting

Problem	Reason	Solution
Laundry remains wet at the end of the programme. (*)	Excessive foam might have occurred and automatic foam absorption system might have been activated due to too much detergent usage.	• Use recommended amount of detergent.
(*) Machine does not switch to spinning step when the laundry is not evenly distributed in the drum to prevent any damage to the machine and to its surrounding environment. Laundry should be rearranged and re-spun.		
(**) Regular drum cleaning is not applied. Clean the drum regularly. See 6.2		
	CAUTION: If you cannot eliminate the problem although you follow the instructions in this section, consult your dealer or the Authorised Service Agent. Never try to repair a nonfunctional product yourself.	

8 BUILT-IN INSTALLATION

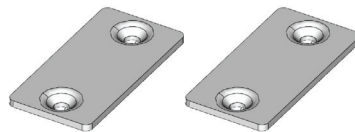
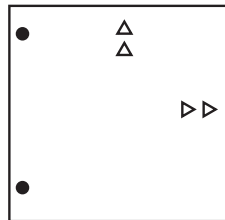
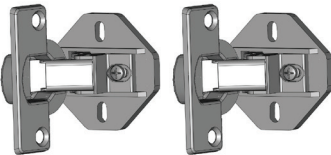
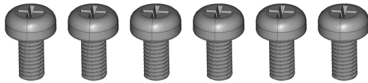
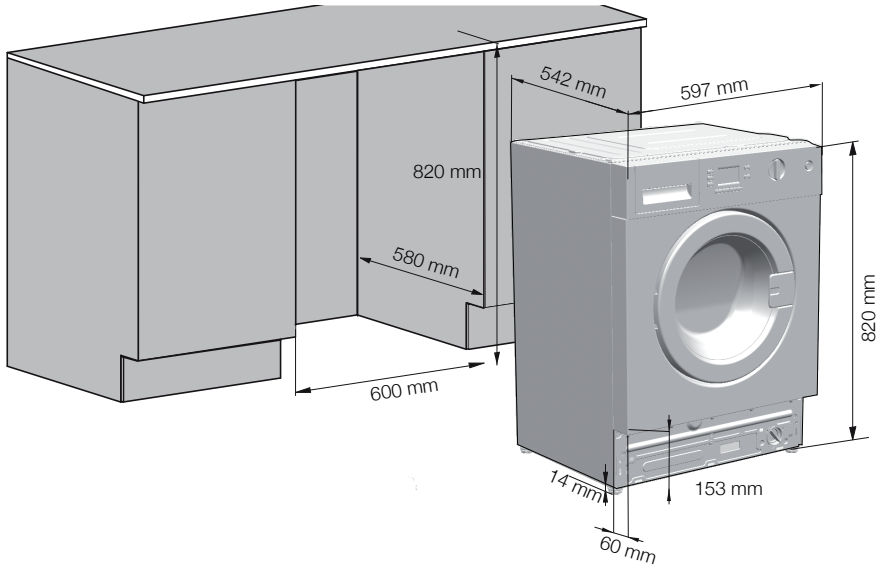

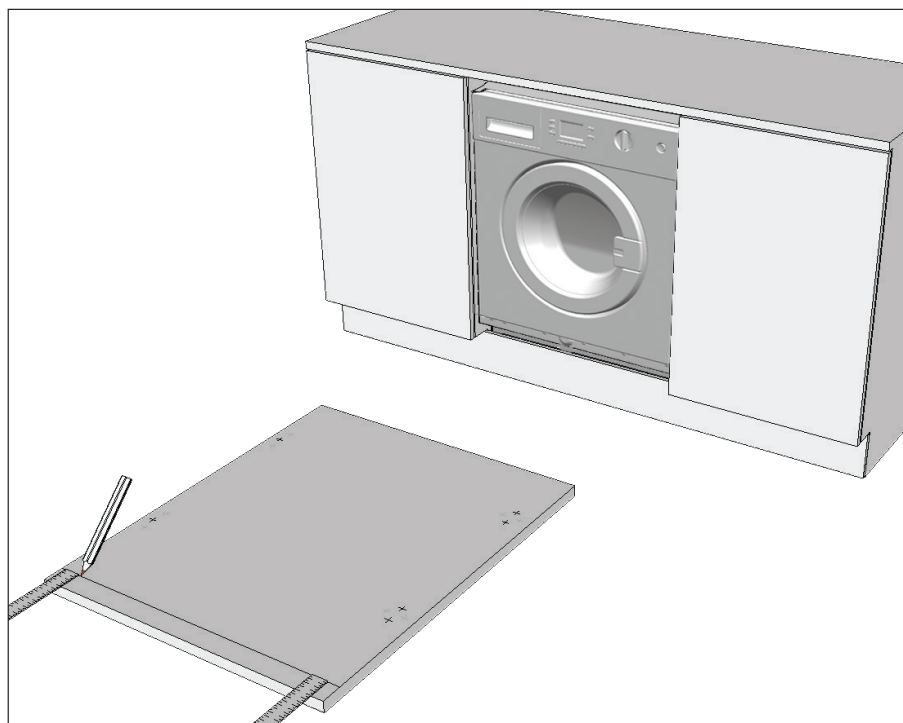
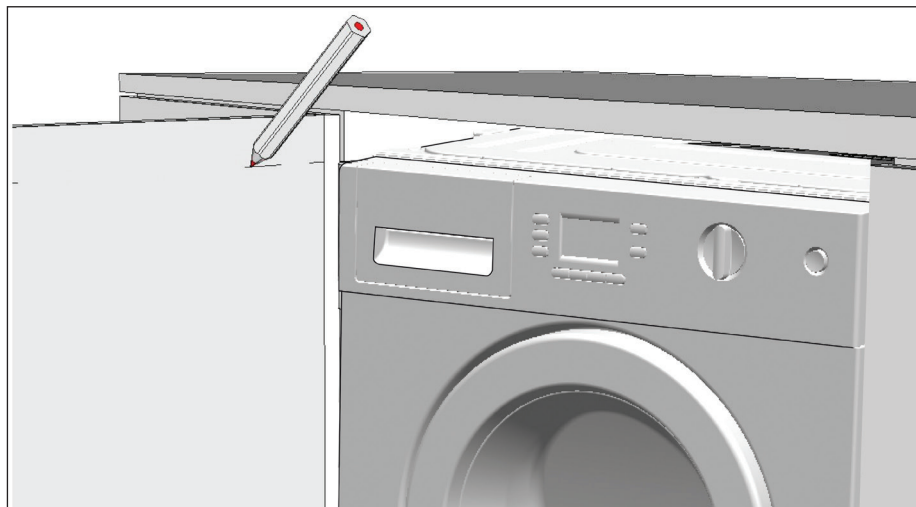

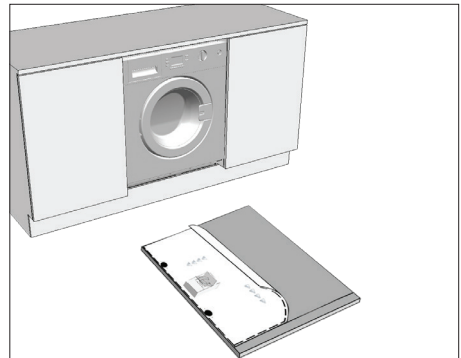
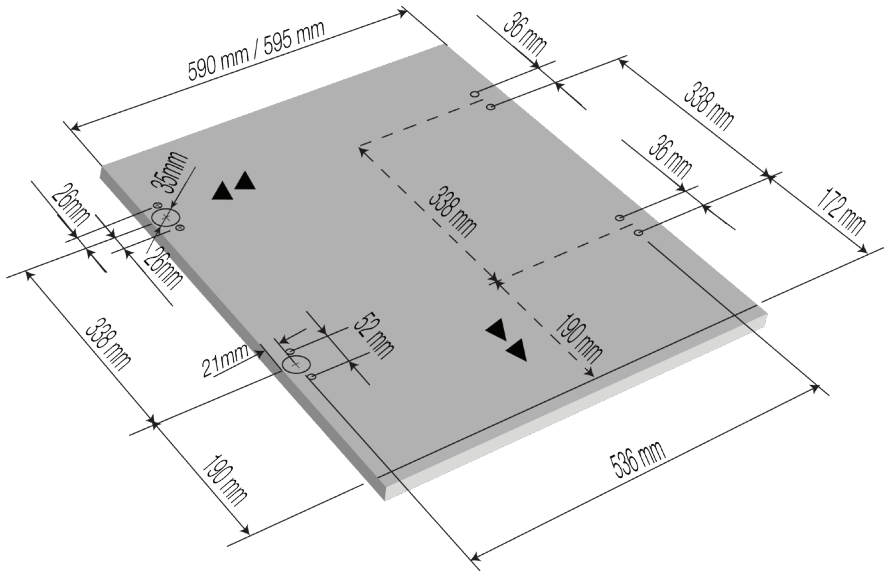
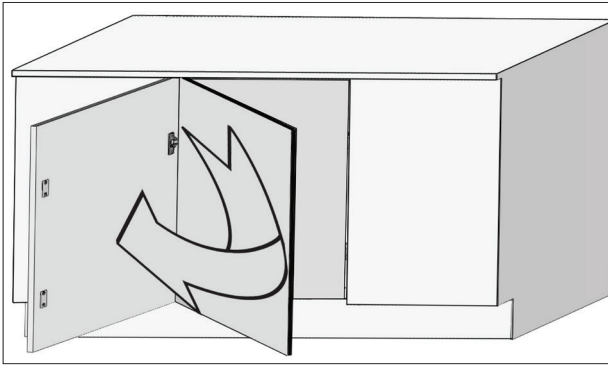

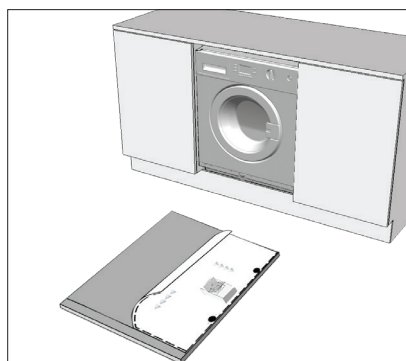
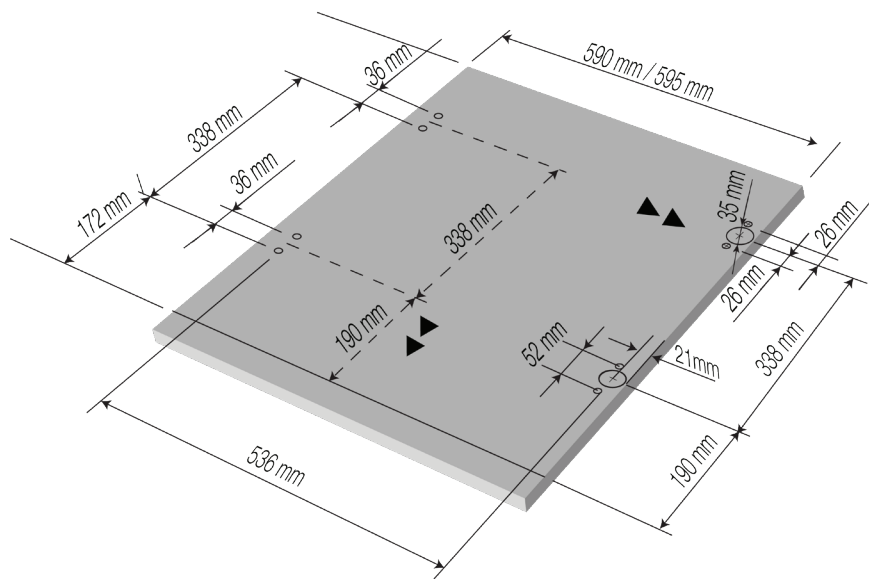
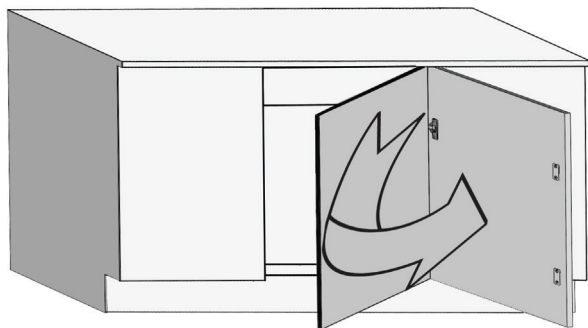

IF THE CABINET DOOR OPENS TO RIGHT

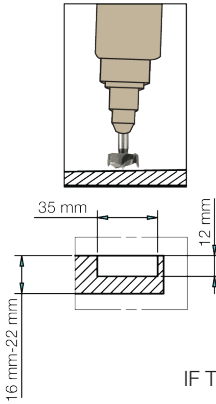
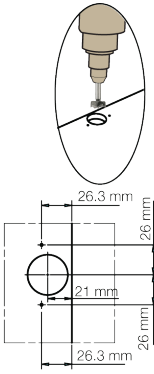
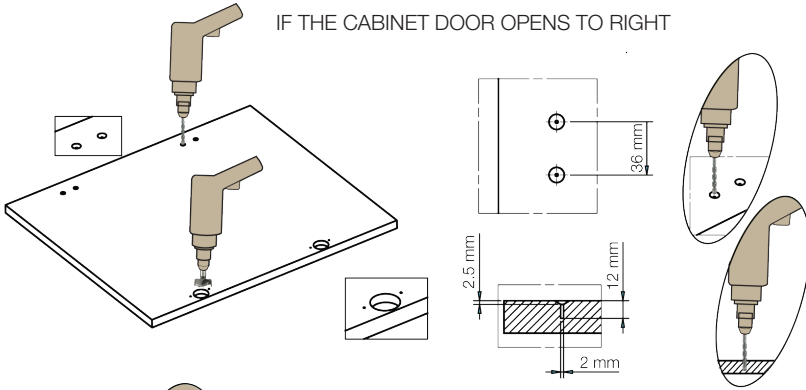

IF THE CABINET DOOR OPENS TO LEFT

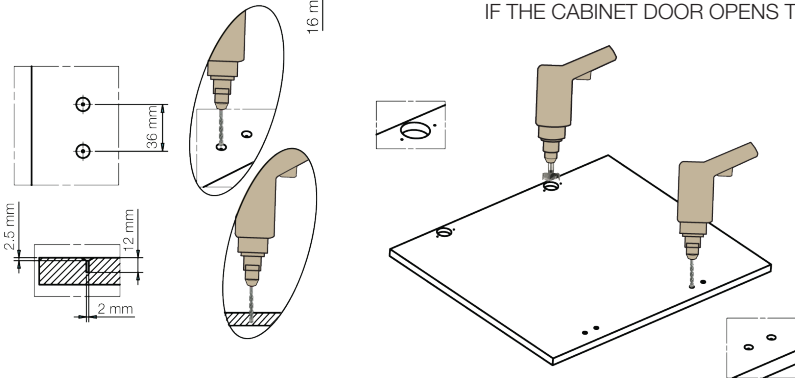

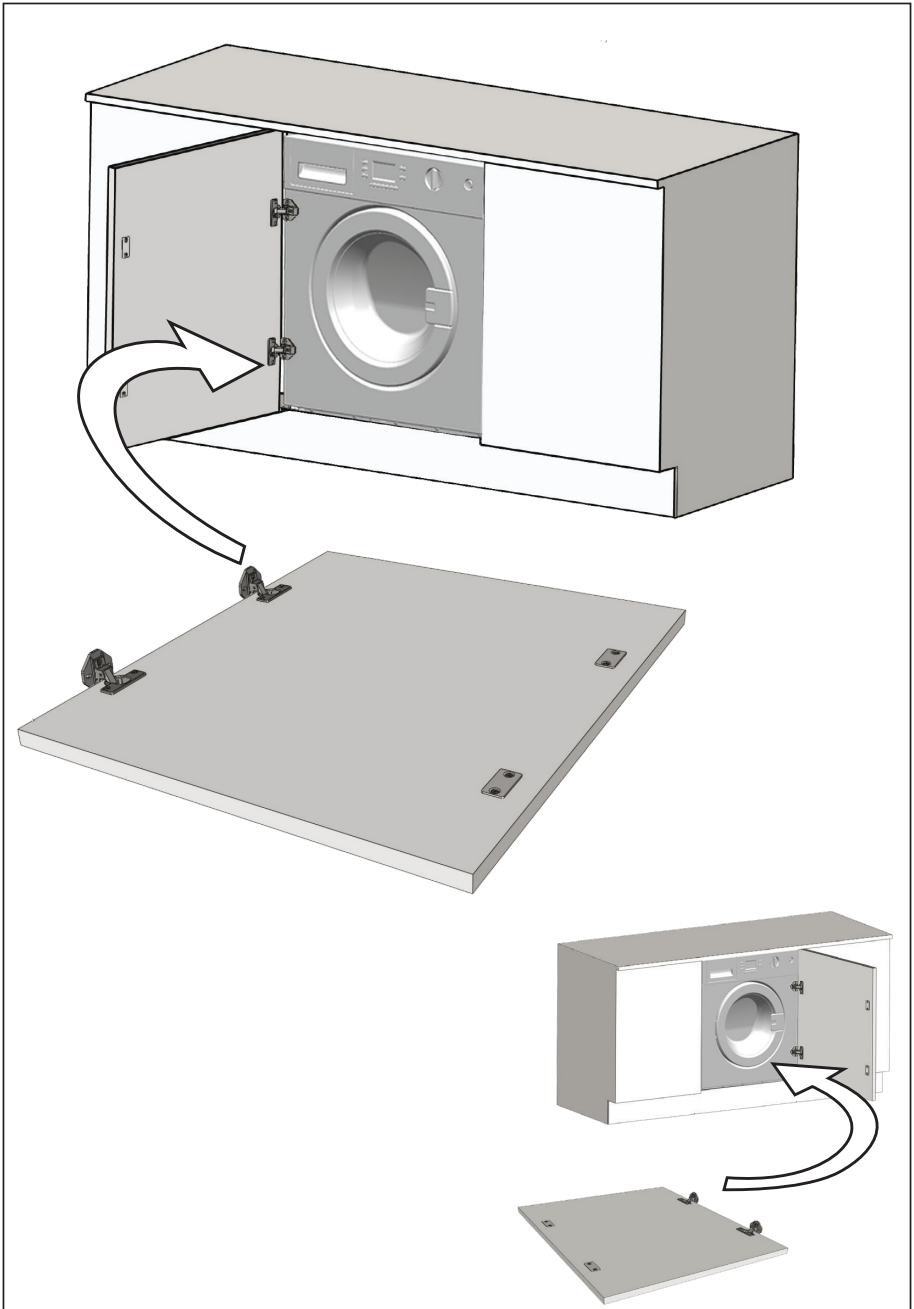

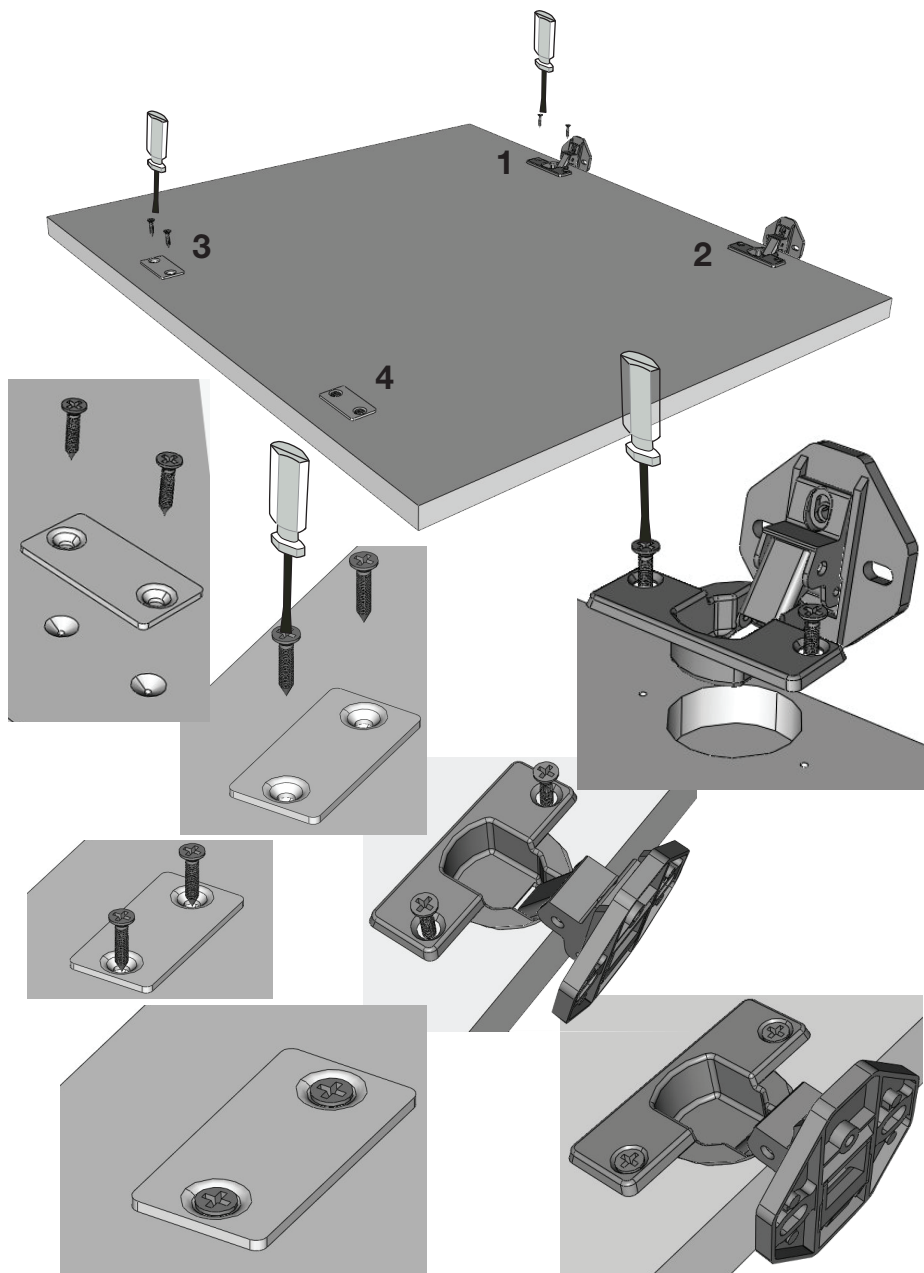



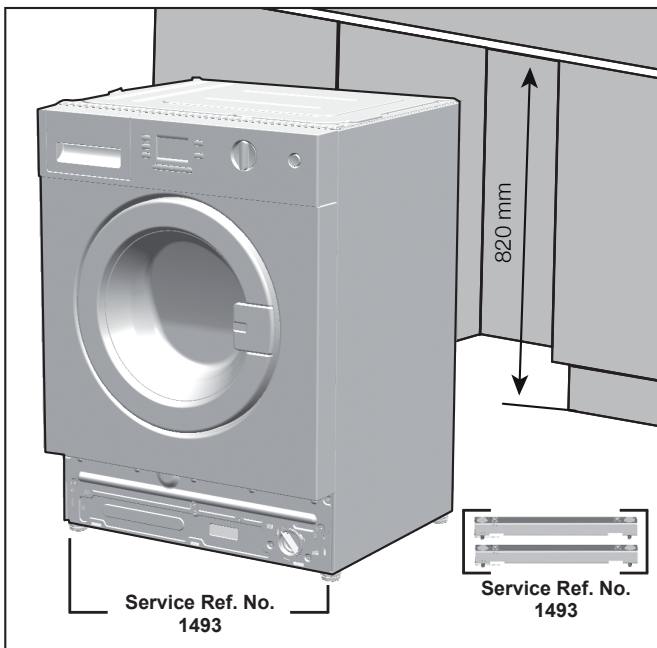
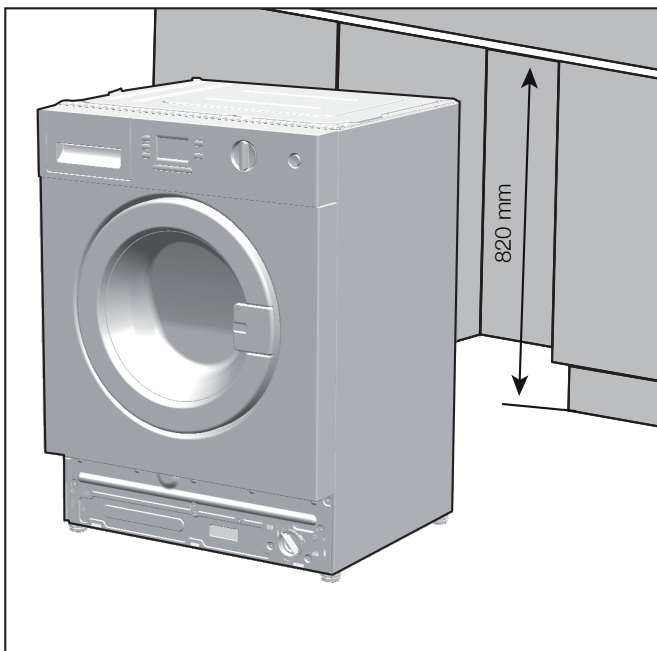

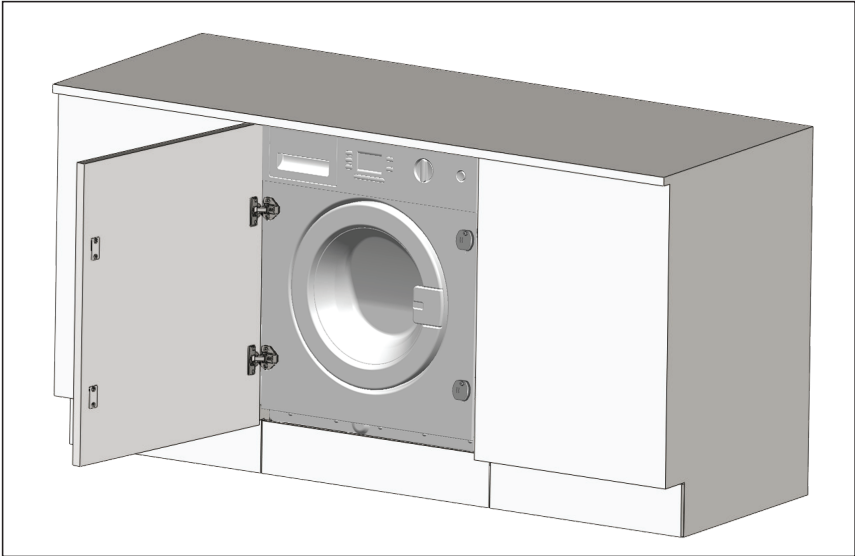

Guarantee Details

Your new Beko product is guaranteed against faulty materials, defective components or manufacturing defects. The guarantee starts from the date of original purchase of the product for a period of twelve (12) months unless Beko plc (the "Manufacturer") agrees to extend the guarantee for the product in writing. If you have any questions about the guarantee on your product (including how long it is valid), please contact your retailer or our Call Centre on 0333 207 9710.

This guarantee does not in any way diminish or affect your statutory rights in connection with the product. This guarantee is in addition to your statutory rights as a consumer. If you have any questions about these rights, please contact the retailer from which you purchased the product. In certain circumstances, it is possible that your statutory rights may offer additional or higher levels of protection than those offered under the terms of this guarantee.

What is covered by this guarantee?

- Repairs to the product required as a result of faulty materials, defective components or manufacturing defects.
- Functional replacement parts to repair a product.
- The costs of a Beko Approved Engineer to carry out the repair.

What is not covered?

- Transit and delivery damage.
- Cabinet or appearance parts, including but not limited to control knobs, flaps and handles.
- Accessories and/or consumable items including but not limited to ice trays, scrapers, cutlery baskets, filters and light bulbs.
- Repairs necessary as a direct or indirect result of:
 - Accidental damage, misuse or abuse of a product.
 - An attempted repair of a product by anyone other than a Beko Approved Engineer (the "Engineer").
 - Installation or use of a product where such installation or use fails to meet the requirements contained in this guarantee or the User Instructions Booklet.
- Repairs to a product operated at any time on commercial or non-residential household premises (unless we have previously agreed to the installation environment).

This guarantee is limited to the cost of repairing the product. To the extent permitted by law, the Manufacturer does not accept and will not be held liable for any financial loss incurred in connection with the failure of any product to operate in accordance with the expected standards. Such financial loss includes but is not limited to loss arising from:

- Time taken off work.
- Damaged food, clothing or other items.
- Meals taken at restaurants or from takeaways.

- General compensation for inconvenience.

Important Notes

- Your product is designed and built for domestic household use only.
- The guarantee will automatically be void if the product is installed or is used in commercial or non-residential domestic household premises, unless we have previously agreed to the installation environment.
- The product must be correctly installed, located and operated in accordance with the instructions contained in the User Instructions Booklet provided with your product.
- Professional installation by a qualified Electrical Domestic Appliance Installer is recommended for all Washing Machines, Dishwashers and Electric Cookers (as incorrect installation may result in you having to pay for the cost of repairing the product).
- Gas Cookers must be professionally installed by a Gas Safe (or Gas Networks Ireland for Republic of Ireland) registered gas installer.
- This guarantee is given in respect of products purchased and used within the United Kingdom and the Republic of Ireland.
- This guarantee is effective from the initial date of purchase of a new product from an authorised retailer and will be void if the product is resold.
- This guarantee does not apply to graded sales (where the product is purchased as a "second").
- Possession of a copy of these terms and conditions does not necessarily mean that a product has the benefit of this guarantee. If you have any questions, please call our Call Centre on the number set out above.
- The Manufacturer reserves the right to terminate the guarantee if its staff or representatives are subjected to physical or verbal abuse in the course of carrying out their duties.
- Optional extras, where available (i.e. extendable feet) are supplied on a chargeable basis only.

Does Beko offer replacements?

This is a repair-only guarantee. On occasion, the Manufacturer may at its sole discretion, replace your product with a new product instead of carrying out a repair. Where a replacement is offered, this would normally be an identical model but when this is not possible, a model of similar specification will be provided. The Manufacturer will cover the costs and arrange for the delivery of the new product and for the return of the old product. Any costs related to disconnecting the faulty product and installing the replacement product will not be borne by the Manufacturer unless previously agreed to in writing. The original guarantee will continue to apply to the replacement product; the new product will not come with a new guarantee.

When will the repair take place?

Our Engineers work Monday to Friday 9.00am to 5.00pm. Appointments outside these hours may be possible at the sole discretion of the Manufacturer but cannot be guaranteed. Whilst our Engineers will endeavour to minimize inconvenience and to meet requests for specific timed appointments, this cannot be guaranteed. We will not be liable for delays or if it is unable to carry out a repair because a convenient appointment cannot be arranged.

Will there be any charge for the repairs?

It is your responsibility to provide evidence to the Engineer that your product is covered by this guarantee with a proof of purchase. The Manufacturer reserves the right to charge for the reasonable cost of any service call if:

- You cannot provide evidence that your product is covered by this guarantee.
- Where a service call has been made and the engineer finds that there is no fault with your product.
- That your product has not been installed or operated in accordance with the User Instructions Booklet.
- That the fault was caused by something other than faulty materials, defective components or manufacturing defects.
- For missed appointments.

Payment of these costs are due immediately upon the Engineer providing you with an invoice. The Manufacturer reserves the right to terminate the guarantee if you fail to pay the costs for the service call in a timely manner.

If you are a resident of the United Kingdom, this guarantee will be governed by English law and subject to the English Courts, save where you live in another part of the United Kingdom, in which case the law and courts of that location will apply.

If you are resident in the Republic of Ireland, this guarantee will be governed by Irish law and the Irish courts will have jurisdiction.

HOW TO OBTAIN SERVICE

Please keep your purchase receipt or other proof of purchase in a safe place; you will need to have it should the product require attention under guarantee.

It will be useful if you complete the details below, as it will help us assist you when requesting service (the model number is printed on the Instruction Booklet and the serial number is printed on the Rating Label affixed to the appliance). Recording of these details alone will not count as proof of purchase. A valid proof of purchase is required for under guarantee service.

The area around the product must be easily accessible to the Engineer without the need for cabinets or furniture being removed.

It is your responsibility to ensure our Engineers have a clean and safe environment to carry out any repairs.

.....
Model No:

Serial No:

Retailer:

Date of purchase:
.....

For service under guarantee simply telephone the appropriate number below:

UK Mainland & Northern Ireland: 0333 207 9710 or customerservice@support.Beko.co.uk

Republic of Ireland: 01 862 3411 or customerservice@support.Beko.ie

Register your appliance: For UK registrations visit beko.co.uk/register and for the Republic of Ireland beko.ie/register.

Before requesting service please check the troubleshooting guide in the Operating Instructions as a charge may be levied where no fault is found even though your product may still be under guarantee.

Service once the manufacturers guarantee has expired

If you have purchased an extended guarantee please refer to the instructions contained within the extended guarantee agreement document, otherwise please call the appropriate number above where service can be obtained at a charge.

Should you experience any difficulty in obtaining service contact the Beko Customer Helpline on Tel: 0333 207 9710 or e-mail: CustomerService@support.beko.co.uk

.....
This guarantee is provided by Beko plc. Beko House, 1 Greenhill Crescent, Watford, Herts, WD18 8QU. Beko plc is registered in England and Wales with company registration number 02415578.



Free Manuals Download Website

<http://myh66.com>

<http://usermanuals.us>

<http://www.somanuals.com>

<http://www.4manuals.cc>

<http://www.manual-lib.com>

<http://www.404manual.com>

<http://www.luxmanual.com>

<http://aubethermostatmanual.com>

Golf course search by state

<http://golfingnear.com>

Email search by domain

<http://emailbydomain.com>

Auto manuals search

<http://auto.somanuals.com>

TV manuals search

<http://tv.somanuals.com>