

USER MANUAL

LHC210A, LHC211A, LHC212A, LGC210A, LGC211A, LGC212A, LHGC-RACK

MEDIA CONVERTERS AND CHASSIS

24/7 TECHNICAL SUPPORT AT 1.877.877.2269 OR VISIT BLACKBOX.COM

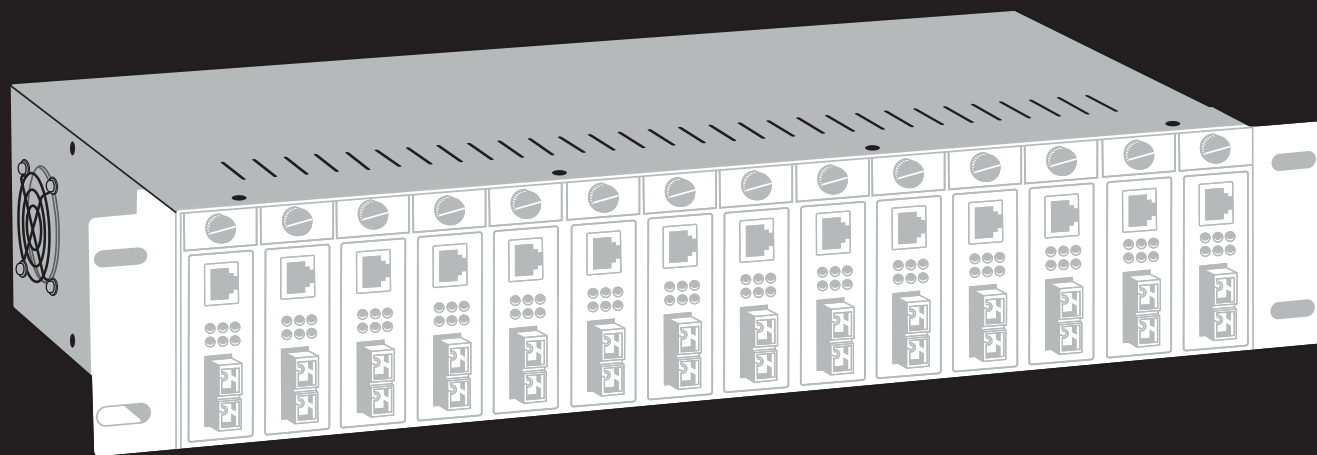

TABLE OF CONTENTS

1. SPECIFICATIONS	3
2. OVERVIEW	4
2.1 Introduction.....	4
2.2 Features	4
2.3 What's Included.....	4
2.4 Hardware Description	5
2.4.1 LHC210A.....	5
2.4.2 LHC211A.....	6
2.4.3 LHC212A	7
2.4.4 LGC210A.....	8
2.4.5 LGC211A.....	9
2.4.6 LGC212A.....	10
2.4.7 LHGC-RACK.....	11
2.5 Application Diagram	12
3. INSTALLING THE CONVERTERS	13
3.1 Initial Steps for Standalone or Rackmount Installation	13
3.1.1 Install the SFP Module in the SFP Cage (LHC210A and LGC210A Only).....	13
3.1.2 Set the DIP Switches (LHC210A, LHC211A and LHC212A Only).....	13
3.2 Installing the Converter as a Standalone Unit.....	15
3.2.1 Connect the Media Cables (LHC210A, LHC211A, LHC212A, LGC210A, LGC211A, LGC212A).....	15
3.3 Installing the Media Converters in the 14-Slot Chassis.....	15
3.3.1 Install the Chassis in a 19" Cabinet or Rack	15
3.3.2 Plug the Media Converters into the Chassis Slots.....	15
3.3.3 Connect the Network Cables	15
3.4 Installation Diagram.....	16
4. MAINTENANCE AND TROUBLESHOOTING	17
4.1 Maintenance	17
4.1.1 Finding Out the Problems	17
4.1.2 Replacing the Power Supply	17
4.2 Troubleshooting	17
APPENDIX A: REGULATORY INFORMATION	18
A.1 FCC Statement	18
A.2 NOM Statement	19
APPENDIX B: DISCLAIMER/TRADEMARKS	20
B.1 Disclaimer	20
B.2 Trademarks Used in this Manual.....	20



CHAPTER 1: SPECIFICATIONS

TABLE 1-1. CHASSIS SPECIFICATIONS

SPECIFICATION	DESCRIPTION
Number of Slots	14
Compatible Media Converters	LHC210A, LHC211A, LHC212A, LGC210A, LGC211A, LGC212A
Media Supported	10/100/1000BASE-T twisted pair and 10/100/1000BASE-FX fiber optic cable
Connectors	Depends on media converters installed
Power	Dual Power supplies included: (1) LHGC-RACK-PS-L and (1) LHGC-RACK-PS-R; Input: 100-240 VAC, 50/60 Hz, 3.0 A; Output: 5 VDC, 12 A, 60 W; Connector: IEC320 C14 on each power supply; Circuit breaker for overvoltage or short circuit protection
Temperature	Operating: 32 to 122° F (0 to 50° C); Storage: -4 to 185° F (-20 to +85° C)
Relative Humidity	5 to 95%, noncondensing
Dimensions	3.5" H (2U) x 19" W x 9.1" D (8.9 x 48.2 x 23.1 cm)
Weight	15.4 lb. (7.0 kg)
Mounting	Comes with blanks and mounting hardware for 14 converters

TABLE 1-2. MEDIA CONVERTERS SPECIFICATIONS

SPECIFICATION	DESCRIPTION
Approvals	FCC Class B, CE, RoHS
Standards	LHC210A, LHC211A, LHC212A: 10/100BASE-TX, 100BASE-FX; LGC210A: LGC211A, LGC212A: 10/100BASE-TX/1000BASE-TX, 1000BASE-FX
Media Supported	10/100/1000BASE-T: CAT5 UTP/STP, max. 328 ft. (100 m); 100/1000BASE-FX
Connectors	All: (1) RJ-45, LHC210A, LGC210A: (1) SFP slot; LHC211A, LGC211A: (1) MM SC; LHC212A, LGC212A: (1) SM SC;
User Controls	LHC210A, LHC211A, LHC212A: (2) 4-position DIP switches
Maximum Distance	LHC210A, LGC210A: Depends on SFP installed; LHC211A: 1.2 mi. (2 km) over multimode fiber optic cable; LHC212A: 12.4 mi. (20 km) over single-mode fiber optic cable; LGC211A: 1640 ft. (500 m) over multimode fiber optic cable; LGC212A: 6.2 mi. (10 km) over single-mode fiber optic cable
NIC Transmission Rate	LHC210A, LHC211A, LHC212A: 10/100 Mbps, auto MDI/MDI-X; LGC210A, LGC211A, LGC212A: 10/100/1000 Mbps, auto MDI/MDI-X
Optical Port Transmission Rate	LHC210A, LHC211A, LHC212A: 100 Mbps; LGC210A, LGC211A, LGC212A: 1000 Mbps
Optical Connector Wavelength	LHC210A, LGC210A: Depends on SFP installed; LHC211A, LHC212A, LGC212A: 1310 nm; LGC211A: 850 nm
Power	All: 5 VDC; LHC210A, LHC211A, LHC212A: <1 W; LGC210A, LGC211A, LGC212A: <3 W
Temperature	Operating: 32 to 122° F (0 to 50° C); Storage: -4 to 158° F (-20 to +70° C)
Relative Humidity	5 to 90%, noncondensing
Dimensions	Each unit: 1" H x 3.7" W x 2.7" D (2.5 x 9.4 x 6.9 cm)

CHAPTER 2: OVERVIEW

2.1 INTRODUCTION

The 10/100 and 10/100/1000 Media Converters support three types of media for network connection, including 10/100BASE-T and 10/100/1000BASE-T for twisted-pair connection and 1000BASE-FX for single-mode or multimode fiber connection. The chassis can hold up to 14 media converters.

2.2 FEATURES

- ◆ Complies with IEEE 802.3 10/100BASE-TX, 10/100/1000BASE-TX and 1000BASE-TX standards
- ◆ Each media converter has one RJ-45 twisted-pair port and one MM or SM SC port or SFP module slot
- ◆ Twisted-pair port supports auto-adaption rate and full/half-duplex mode, as well as auto MDI/MDI-X
- ◆ Six LEDs indicate optical power and twisted-pair port status
- ◆ Chassis includes a built in power supply and Media Converters come with an external power supply which will not be used if they are going to be used in the chassis
- ◆ Optional 2U chassis holds up to 14 media converters for convenient mounting in a 19" rack or cabinet

2.3 WHAT'S INCLUDED

Before you start installing the Converter, verify that the package contains the following:

LHC210A, LHC211A, LHC212A, LGC210A, LGC211A or LGC212A:

- ◆ The TP-Fiber Converter
- ◆ 5-VDC Power Adapter

LHGC-RACK:

- ◆ (2) Power supplies
- ◆ (14) Rackmount brackets

If anything is missing or damaged, contact Black Box Technical Support at 877-877-2269 or info@blackbox.com



CHAPTER 2: OVERVIEW

2.4 HARDWARE DESCRIPTION

2.4.1 LHC210A

Figures 2-1 and 2-2 show the front and back panels of the LHC210A converter. Tables 2-1 and 2-2 describe its components.

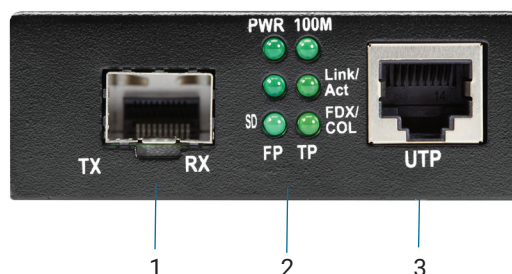

FIGURE 2-1. LHC210A FRONT PANEL

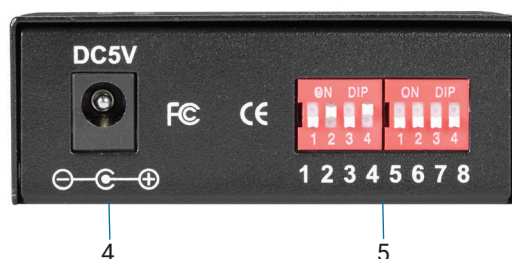

FIGURE 2-2. LHC210A BACK PANEL

TABLE 2-1. LHC210A MEDIA CONVERTER COMPONENTS

NUMBER IN FIGURE 2-1 OR 2-2	COMPONENT	DESCRIPTION
1	SFP cage	SFP module installs here
2	LED indicators	See Table 2-2
3	RJ-45 connector	Links to RJ-45 cable
4	Barrel connector for power	Links to 47–57-VDC power supply
5	(2) 4-position DIP switches, numbered 1–8	See Table 3-2

TABLE 2-2. LHC210A LED INDICATORS

LED NAME	STATUS	DESCRIPTION
PWR	ON	Power is ON and normal
FX Link/ACT	ON	Connection Status display for fiber link. ON indicates that the fiber link is correctly connected
	Blinking	Packet is being transmitted through the FX end
SD	ON	Fiber signal is detected
100M	ON	Link is operating at 100 Mbps
	OFF	Link is operating at 10 Mbps
TX Link/Act	ON	Connection status display for copper link. ON indicates that the link is correctly connected
TX FDX/COL	Blinking	Active status display of copper link. Packet is being transmitted through the TX end

CHAPTER 2: OVERVIEW

2.4.2 LHC211A

Figures 2-3 and 2-4 show the front and back panels of the LHC211A converter. Tables 2-3 and 2-4 describe its components.

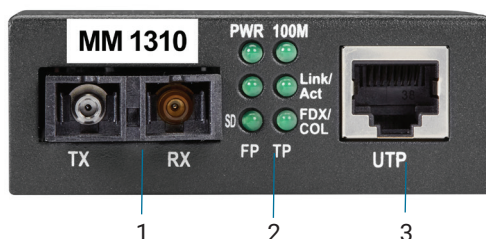

FIGURE 2-3. LHC211A FRONT PANEL



FIGURE 2-4. LHC211A BACK PANEL

TABLE 2-3. LHC211A MEDIA CONVERTER COMPONENTS

NUMBER IN FIGURE 2-3 OR 2-4	COMPONENT	DESCRIPTION
1	MM 1310 Fiber SC connectors	Links to 1310 MM Fiber cable
2	LED indicators	See Table 2-4
3	RJ-45 connector	Links to RJ-45 cable
4	Barrel connector for power	Links to 47–57-VDC power supply
5	(2) 4-position DIP switches, numbered 1–8	See Table 3-2

TABLE 2-4. LHC211A LED INDICATORS

LED NAME	STATUS	DESCRIPTION
PWR	ON	Power is ON and normal
FX Link/ACT	ON	Connection Status display for fiber link. ON indicates that the fiber link is correctly connected
	Blinking	Packet is being transmitted through the FX end
SD	ON	Fiber signal is detected
100M	ON	Link is operating at 100 Mbps
	OFF	Link is operating at 10 Mbps
TX Link/Act	ON	Connection status display for copper link. ON indicates that the link is correctly connected
TX FDX/COL	Blinking	Active status display of copper link. Packet is being transmitted through the TX end

CHAPTER 2: OVERVIEW

2.4.3 LHC212A

Figures 2-5 and 2-6 show the front and back panels of the LHC212A converter. Tables 2-5 and 2-6 describe its components.

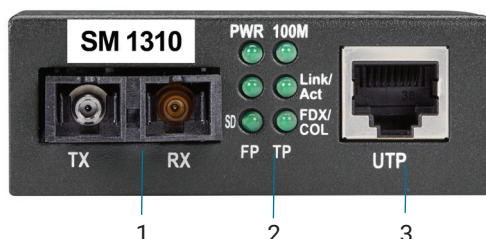

FIGURE 2-5. LHC212A FRONT PANEL



FIGURE 2-6. LHC212A BACK PANEL

TABLE 2-5. LHC212A MEDIA CONVERTER COMPONENTS

NUMBER IN FIGURE 2-5 OR 2-6	COMPONENT	DESCRIPTION
1	SM 1310 Fiber SC connectors	Links to 1310 SM Fiber cable
2	LED indicators	See Table 2-6
3	RJ-45 connector	Links to RJ-45 cable
4	Barrel connector for power	Links to 47–57-VDC power supply
5	(2) 4-position DIP switches, numbered 1–8	See Table 3-2

TABLE 2-6. LHC212A LED INDICATORS

LED NAME	STATUS	DESCRIPTION
PWR	ON	Power is ON and normal
FX Link/ACT	ON	Connection Status display for fiber link. ON indicates that the fiber link is correctly connected
	Blinking	Packet is being transmitted through the FX end
SD	ON	Fiber signal is detected
100M	ON	Link is operating at 100 Mbps
	OFF	Link is operating at 10 Mbps
TX Link/Act	ON	Connection status display for copper link. ON indicates that the link is correctly connected
TX FDX/COL	Blinking	Active status display of copper link. Packet is being transmitted through the TX end

CHAPTER 2: OVERVIEW

2.4.4 LGC210A

Figures 2-7 and 2-8 show the front and back panels of the LGC210A converter. Tables 2-7 and 2-8 describe its components.

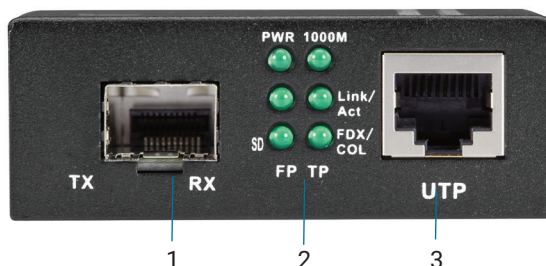

FIGURE 2-7. LGC210A FRONT PANEL

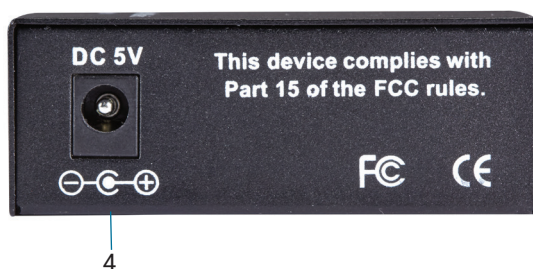

FIGURE 2-8. LGC210A BACK PANEL

TABLE 2-7. LGC210A MEDIA CONVERTER COMPONENTS

NUMBER IN FIGURE 2-7 OR 2-8	COMPONENT	DESCRIPTION
1	SFP cage	SFP module installs here
2	LED indicators	See Table 2-8
3	RJ-45 connector	Links to RJ-45 cable
4	Barrel connector for power	Links to 47–57-VDC power supply

TABLE 2-8. LGC210A LED INDICATORS

LED NAME	STATUS	DESCRIPTION
PWR	ON	Power is ON and normal
FX Link/ACT	ON	Connection Status display for fiber link. ON indicates that the fiber link is correctly connected
	Blinking	Packet is being transmitted through the FX end
SD	ON	Fiber signal is detected
1000M	ON	Link is operating at 1000 Mbps
	OFF	Link is operating at 10/100 Mbps
TX Link/Act	ON	Connection status display for copper link. ON indicates that the link is correctly connected
TX FDX/COL	Blinking	Active status display of copper link. Packet is being transmitted through the TX end

CHAPTER 2: OVERVIEW

2.4.5 LGC211A

Figures 2-9 and 2-10 show the front and back panels of the LGC211A converter. Tables 2-9 and 2-10 describe its components.

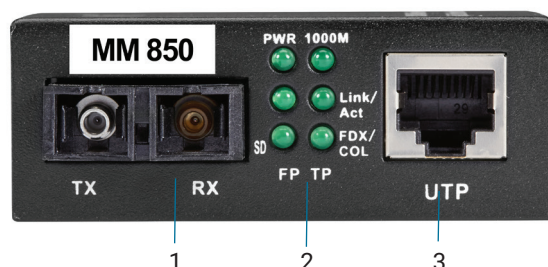

FIGURE 2-9. LGC211A FRONT PANEL



FIGURE 2-10. LGC211A BACK PANEL

TABLE 2-9. LGC211A MEDIA CONVERTER COMPONENTS

NUMBER IN FIGURE 2-9 OR 2-10	COMPONENT	DESCRIPTION
1	MM 850 Fiber SC connectors	Links to 850 MM Fiber cable
2	LED indicators	See Table 2-10
3	RJ-45 connector	Links to RJ-45 cable
4	Barrel connector for power	Links to 47–57-VDC power supply

TABLE 2-10. LGC211A LED INDICATORS

LED NAME	STATUS	DESCRIPTION
PWR	ON	Power is ON and normal
FX Link/ACT	ON	Connection Status display for fiber link. ON indicates that the fiber link is correctly connected
	Blinking	Packet is being transmitted through the FX end
SD	ON	Fiber signal is detected
1000M	ON	Link is operating at 1000 Mbps
	OFF	Link is operating at 10/100 Mbps
TX Link/Act	ON	Connection status display for copper link. ON indicates that the link is correctly connected
TX FDX/COL	Blinking	Active status display of copper link. Packet is being transmitted through the TX end

CHAPTER 2: OVERVIEW

2.4.6 LGC212A

Figures 2-11 and 2-12 show the front and back panels of the LGC212A converter. Tables 2-11 and 2-12 describe its components.

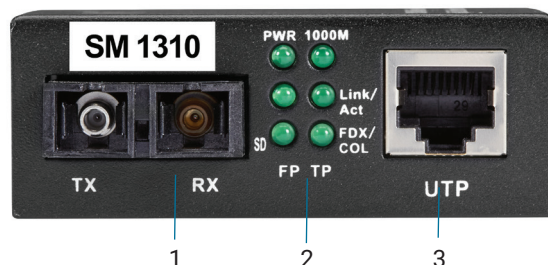

FIGURE 2-11. LGC212A FRONT PANEL



FIGURE 2-12. LGC212A BACK PANEL

TABLE 2-11. LGC212A MEDIA CONVERTER COMPONENTS

NUMBER IN FIGURE 2-11 OR 2-12	COMPONENT	DESCRIPTION
1	SM 1310 Fiber SC connectors	Links to 1310 SM Fiber cable
2	LED indicators	See Table 2-12
3	RJ-45 connector	Links to RJ-45 cable
4	Barrel connector for power	Links to 47–57-VDC power supply

TABLE 2-12. LGC212A LED INDICATORS

LED NAME	STATUS	DESCRIPTION
PWR	ON	Power is ON and normal
FX Link/ACT	ON	Connection Status display for fiber link. ON indicates that the fiber link is correctly connected
	Blinking	Packet is being transmitted through the FX end
SD	ON	Fiber signal is detected
1000M	ON	Link is operating at 1000 Mbps
	OFF	Link is operating at 10/100 Mbps
TX Link/Act	ON	Connection status display for copper link. ON indicates that the link is correctly connected
TX FDX/COL	Blinking	Active status display of copper link. Packet is being transmitted through the TX end

CHAPTER 2: OVERVIEW

2.4.7 LHGC-RACK

Figure 2-13 shows the front of the rackmount chassis with media converters and blank slot covers installed. Figure 2-14 shows the back of the rackmount chassis. Table 2-13 describes its components.



FIGURE 2-13. LHGC-RACK, FRONT VIEW

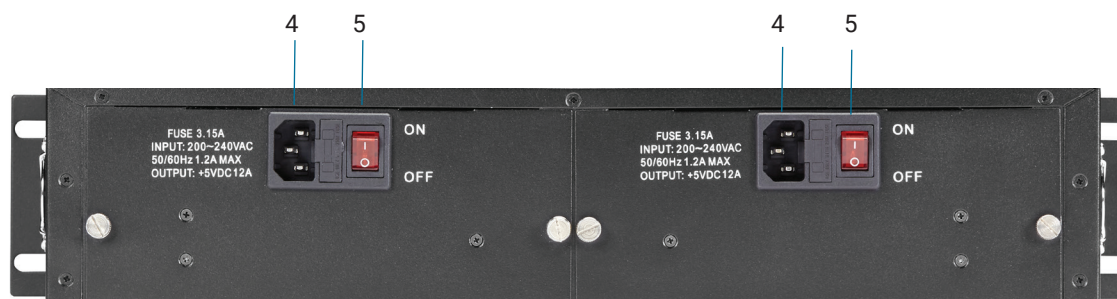

FIGURE 2-14. LHGC-RACK, BACK VIEW

TABLE 2-13. MEDIA CONVERTER CHASSIS COMPONENTS

NUMBER IN FIGURE 2-12 OR 2-14	COMPONENT	DESCRIPTION
1	Blank slot cover	SFP module installs here
2	Media Converter	Media Converter installs here
3	Rackmount ears	Attaches to 19" rack or cabinet
4	3-prong outlet	Links to power cord
5	ON/OFF switch	Turns power ON or OFF

2.5 APPLICATION DIAGRAM

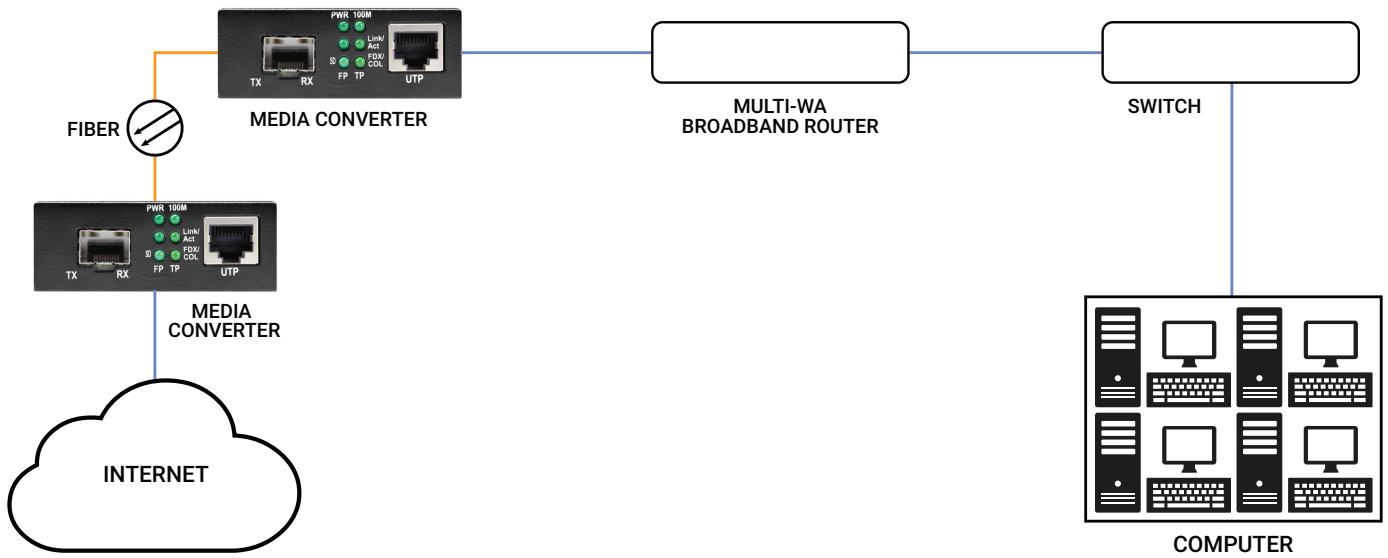

FIGURE 2-15 APPLICATION DIAGRAM

CHAPTER 3: INSTALLING THE CONVERTER

3.1 INITIAL STEPS FOR STANDALONE OR RACKMOUNT INSTALLATION

3.1.1 INSTALL THE SFP MODULE IN THE SFP CAGE (LHC210A AND LGC210A ONLY)

Gently insert a compatible SFP module in the SFP cage on the LHC210A or LGC210A media converter.

See the table below for a list of compatible SFP modules.

TABLE 3-1. COMPATIBLE SFP MODULES (INSTALL IN LHC210A OR LGC210A ONLY)

PRODUCT CODE	DESCRIPTION	COMPATIBLE MEDIA CONVERTER
LFP401	SFP - 155-Mbps, Extended Diagnostics, 850-nm Multimode Fiber, 2-km, LC	LHC210A
LFP402	SFP - 155-Mbps, Extended Diagnostics, 1310-nm Multimode Fiber, 2-km, LC	LHC210A
LFP403	SFP - 155-Mbps, Extended Diagnostics, 1310-nm Single-Mode Fiber, 30-km, LC	LHC210A
LFP404	SFP - 155-Mbps, Extended Diagnostics, 1310-nm Single-Mode Fiber, 60-km, LC	LHC210A
LFP411	SFP - 1250-Mbps, Extended Diagnostics, 850-nm Multimode Fiber, 550-m, LC	LGC210A
LFP412	SFP - 1250-Mbps, Extended Diagnostics, 1310-nm Multimode Fiber, 2-km, LC	LGC210A
LFP413	SFP - 1250-Mbps, Extended Diagnostics, 1310-nm Single-Mode Fiber, 10-km, LC	LGC210A
LFP414	SFP - 1250-Mbps, Extended Diagnostics, 1310-nm Single-Mode Fiber, 30-km, LC	LGC210A
LFP418	SFP - 1250-Mbps, Extended Diagnostics, 1550-nm Single-Mode Fiber, 80-km, LC	LGC210A
LFP420, LFP421	SFP - 1250-Mbps, Extended Diagnostics, 1550-nm TX, 1310-nm RX, Simplex, Single-Mode Fiber, 10-km, LC; SFP - 1250-Mbps, Extended Diagnostics, 1310-nm TX, 1550-nm RX, Simplex Single-Mode Fiber, 10-km, LC	LGC210A
LFP416	SFP - 1250-Mbps, Extended Diagnostics, 10/100/1000BASE-T, SGMII Interface, RJ-45	LGC210A

NOTE: LFP420, LFP421 are single-strand fiber SFPs, so they must be used in pairs.

NOTE: Use the LFP416 for a copper interface.

3.1.2 SET THE DIP SWITCHES (LHC210A, LHC211A AND LHC212A ONLY)

The LHC210A, LHC211A and LHC212A have an 8-position DIP switch, shown in Figure 3-1. The DIP switch functions are described in Table 3-2.

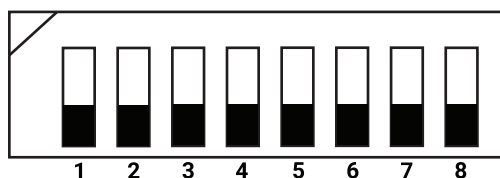

FIGURE 3-1. DIP SWITCH ON THE LHC210A, LHC211A AND LHC212A

CHAPTER 3: INSTALLING THE CONVERTER**TABLE 3-2. LHC210A, LHC211A AND LHC212A DIP SWITCH SETTINGS**

DIP SWITCH POSITIONS								DESCRIPTION
1	2	3	4	5	6	7	8	
ON	–	–	–	–	–	–	–	LFP enabled
OFF	–	–	–	–	–	–	–	LFP disabled
–	OFF	OFF	–	–	–	–	–	Store and Forward
OFF	ON	OFF	ON	ON	OFF	OFF	OFF	Jumbo enabled
–	OFF	ON	–	–	–	–	–	Modified cut-through switch mode enabled
–	ON	OFF	–	–	–	–	–	Converter mode enabled
–	ON	ON	–	–	–	–	–	Auto-change-forward enabled
–	–	–	–	–	–	–	OFF	Force fiber port to full-duplex mode
–	–	–	–	OFF	–	–	–	IEEE 802.3x enabled
–	–	–	–	ON	–	–	–	IEEE 802.3x disabled
–	–	–	OFF	–	OFF	OFF	–	Force TX port to 10M/100M full duplex/half-duplex with auto-negotiation
–	–	–	OFF	–	OFF	ON	–	Force TX port to 10M/100M half-duplex with auto-negotiation
–	–	–	OFF	–	ON	OFF	–	Force TX port to 10M full duplex/half-duplex with auto-negotiation
–	–	–	OFF	–	ON	OFF	–	Force TX port to 10M half-duplex with auto-negotiation
–	–	–	ON	–	OFF	OFF	–	Force TX port to 100M full duplex with auto-negotiation
–	–	–	ON	–	OFF	ON	–	Force TX port to 100M half-duplex with auto-negotiation
–	–	–	ON	–	ON	OFF	–	Force TX port to 10M full duplex with auto-negotiation
–	–	–	ON	–	ON	ON	–	Force TX port to 10M half-duplex with auto-negotiation



CHAPTER 3: INSTALLING THE CONVERTER

3.2 INSTALLING THE CONVERTER AS A STANDALONE UNIT

3.2.1 CONNECT THE MEDIA CABLES (LHC210A, LHC211A, LHC212A, LGC210A, LGC211A, LGC212A)

1. Verify that the AC-DC adapter conforms to your country's AC power requirement and insert the power plug.
2. Connect the media cable for network connection.
 - 2a. For the fiber port, the TX/RX fiber cable must be paired at both ends. The default setting for the converter is full-duplex mode.
 - 2b. For the twisted-pair port, attach the CAT5 twisted-pair cable to the RJ-45 port on the converter.

3.3 INSTALLING THE CONVERTERS IN THE 14-SLOT CHASSIS

The 14-slot media converter chassis supports plug-and-play installation of up to 14 table-top media converters. The chassis can supply several media converters with power.

You can hot-swap the media converters in and out of the chassis. The chassis works with a single power supply or dual power supplies, depending on your power requirements.

3.3.1 INSTALL THE CHASSIS IN A 19" CABINET OR RACK

Install the media converter chassis in a standard 19" rack or cabinet and secure it with screws (not included).

3.3.2 PLUG THE MEDIA CONVERTERS INTO THE CHASSIS SLOTS

1. Unscrew the two screws next to the RJ-45 port of the first media converter. Use these two screws to affix the media converter to the chassis.
2. Insert the media converter in to the chassis, making sure the power plug of the chassis is inserted in the power port of the media converter. When the converter is fully and firmly fitted to the chassis, fasten the screws on the chassis.
3. Repeat steps 1 and 2 for the remaining media converters you want to install.

3.3.3 CONNECT THE NETWORK CABLES

1. Insert the RJ-45 twisted-pair cable into the RJ-45 port on the converter, and insert the fiber cable into the fiber port on the converter.
2. Connect the supplied AC power cable to the receptacle at the back of the chassis, attach the plug to a standard 100 to 260 VAC outlet.
3. Turn the power switch ON and the Power LEDs on the front of the chassis will light green.
4. Turn on both power supplies. This extends the life cycle of the power supply and provides redundant power if one power supply fails.

CHAPTER 3: INSTALLING THE CONVERTER

3.4 INSTALLATION DIAGRAM

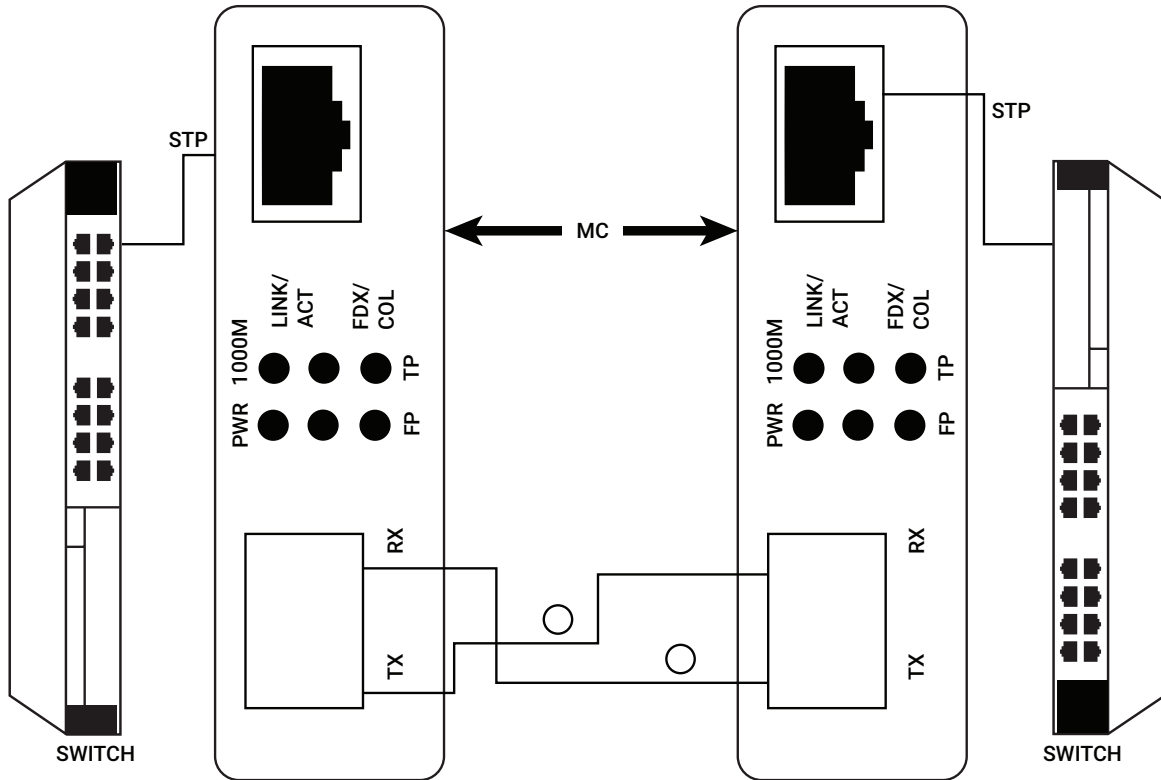

FIGURE 3-2. TYPICAL INSTALLATION

CHAPTER 4: MAINTENANCE AND TROUBLESHOOTING

4.1 MAINTENANCE

4.1.1 FINDING OUT THE PROBLEMS

When the electrical current becomes dangerous, the Power LEDs on the chassis will light red. When the problems have been cleared, the LEDs return to normal.

If the fuse has blown or the power supply has broken down, the POWER LEDs will be off and the fans will not work. (The fuse is under the plug; you can pull it out to check or change it.)

When the fans of chassis have broken down, the POWER LEDs will light green, but the fans will not work. If this happens, replace the power supply.

If the power supply of chassis is operating normally, but the LEDs on the media converters are off, there may be problems with the connection between the plug board of chassis and the power supply. Stop the electrical current, pull out the power adapter and check it, then reinsert the power adapter.

4.1.2 REPLACING THE POWER SUPPLY

When one of the dual power supplies has broken down, the chassis can work normally. The power supplies are hot-swappable, so you don't need to power down the chassis if the redundant power supply is still working. Remove the broken power supply, pull out the plug and replace it with a new power supply and connect the plug.

When a single power supply broken down, follow the above steps. The converters installed in the chassis will stop working until a new power supply is installed and working normally.

4.2 TROUBLESHOOTING

TABLE 4-1. PROBLEMS/CAUSES/SOLUTIONS

PROBLEM	CAUSE	POSSIBLE SOLUTION
Poewr LEDs are OFF	Power plug not connected or not a valid connection	Connect the power plug and make sure it is a valid connection
Link/Act LED is OFF	<ol style="list-style-type: none"> 1. Electrical cables not connected to the electrical port or not a valid connection 2. Wrong cables used for electrical connection 3. NIC or terminal fault 	<ol style="list-style-type: none"> 1. Connect the electrical cables to the electrical port and make sure it's a valid connection 2. Use the correct type of cables 3. Make sure the NIC and Ethernet terminal can work normally
FX and FX Link/Act LEDs are OFF	<ol style="list-style-type: none"> 1. There may be a fault with the terminal optical devices 2. The optical fiber has broken down or the optical fiber connection is not valid 3. The optical fiber is overloss 	Check the terminal optical devices and the main fiber to see if they can work normally. If not, repair or replace them
TX and FX LEDs are normal, but data cannot be transmitted	<ol style="list-style-type: none"> 1. The connection between the optical fiber and devices is not valid 2. The system does not receive enough power 	<ol style="list-style-type: none"> 1. Check the fiber connectors and make sure the connection between optical fiber and devices is valid 2. Turn off the power supply, wait a minute, then power on the unit and try again

APPENDIX A: REGULATORY INFORMATION

A.1 FCC STATEMENT

Class B Digital Device. This equipment has been tested and found to comply with the limits for a Class B computing device pursuant to Part 15 of the FCC Rules. These limits are designed to provide reasonable protection against harmful interference in a residential installation. However, there is no guarantee that interference will not occur in a particular installation. This equipment generates, uses, and can radiate radio frequency energy, and, if not installed and used in accordance with the instructions, may cause harmful interference to radio communications. If this equipment does cause harmful interference to radio or telephone reception, which can be determined by turning the equipment off and on, the user is encouraged to try to correct the interference by one of the following measures:

Reorient or relocate the receiving antenna.

- ◆ Increase the separation between the equipment and receiver.
- ◆ Connect the equipment into an outlet on a circuit different from that to which the receiver is connected.
- ◆ Consult an experienced radio/TV technician for help.

CAUTION:

Changes or modifications not expressly approved by the party responsible for compliance could void the user's authority to operate the equipment.

To meet FCC requirements, shielded cables and power cords are required to connect this device to a personal computer or other Class B certified device.

This digital apparatus does not exceed the Class B limits for radio noise emission from digital apparatus set out in the Radio Interference Regulation of Industry Canada.

Le présent appareil numérique n'émet pas de bruits radioélectriques dépassant les limites applicables aux appareils numériques de classe B prescrites dans le Règlement sur le brouillage radioélectrique publié par Industrie Canada.



APPENDIX A: REGULATORY INFORMATION

A.2 NOM STATEMENT

1. Todas las instrucciones de seguridad y operación deberán ser leídas antes de que el aparato eléctrico sea operado.
2. Las instrucciones de seguridad y operación deberán ser guardadas para referencia futura.
3. Todas las advertencias en el aparato eléctrico y en sus instrucciones de operación deben ser respetadas.
4. Todas las instrucciones de operación y uso deben ser seguidas.
5. El aparato eléctrico no deberá ser usado cerca del agua—por ejemplo, cerca de la tina de baño, lavabo, sótano mojado o cerca de una alberca, etc.
6. El aparato eléctrico debe ser usado únicamente con carritos o pedestales que sean recomendados por el fabricante.
7. El aparato eléctrico debe ser montado a la pared o al techo sólo como sea recomendado por el fabricante.
8. Servicio—El usuario no debe intentar dar servicio al equipo eléctrico más allá a lo descrito en las instrucciones de operación. Todo otro servicio deberá ser referido a personal de servicio calificado.
9. El aparato eléctrico debe ser situado de tal manera que su posición no interfiera su uso. La colocación del aparato eléctrico sobre una cama, sofá, alfombra o superficie similar puede bloquea la ventilación, no se debe colocar en libreros o gabinetes que impidan el flujo de aire por los orificios de ventilación.
10. El equipo eléctrico deber ser situado fuera del alcance de fuentes de calor como radiadores, registros de calor, estufas u otros aparatos (incluyendo amplificadores) que producen calor.
11. El aparato eléctrico deberá ser conectado a una fuente de poder sólo del tipo descrito en el instructivo de operación, o como se indique en el aparato.
12. Precaución debe ser tomada de tal manera que la tierra física y la polarización del equipo no sea eliminada.
13. Los cables de la fuente de poder deben ser guiados de tal manera que no sean pisados ni pellizcados por objetos colocados sobre o contra ellos, poniendo particular atención a los contactos y receptáculos donde salen del aparato.
14. El equipo eléctrico debe ser limpiado únicamente de acuerdo a las recomendaciones del fabricante.
15. En caso de existir, una antena externa deberá ser localizada lejos de las líneas de energía.
16. El cable de corriente deberá ser desconectado del cuando el equipo no sea usado por un largo periodo de tiempo.
17. Cuidado debe ser tomado de tal manera que objetos líquidos no sean derramados sobre la cubierta u orificios de ventilación.
18. Servicio por personal calificado deberá ser provisto cuando:
 - A: El cable de poder o el contacto ha sido dañado; u
 - B: Objetos han caído o líquido ha sido derramado dentro del aparato; o
 - C: El aparato ha sido expuesto a la lluvia; o
 - D: El aparato parece no operar normalmente o muestra un cambio en su desempeño; o
 - E: El aparato ha sido tirado o su cubierta ha sido dañada.

APPENDIX B: DISCLAIMER/TRADEMARKS

B.1 DISCLAIMER

Black Box Corporation shall not be liable for damages of any kind, including, but not limited to, punitive, consequential or cost of cover damages, resulting from any errors in the product information or specifications set forth in this document and Black Box Corporation may revise this document at any time without notice.

B.2 TRADEMARKS USED IN THIS MANUAL

Black Box and the Black Box logo type and mark are registered trademarks of Black Box Corporation.

Any other trademarks mentioned in this manual are acknowledged to be the property of the trademark owners.



**NEED HELP?
LEAVE THE TECH TO US**

**LIVE 24/7
TECHNICAL
SUPPORT**

1.877.877.2269



Free Manuals Download Website

<http://myh66.com>

<http://usermanuals.us>

<http://www.somanuals.com>

<http://www.4manuals.cc>

<http://www.manual-lib.com>

<http://www.404manual.com>

<http://www.luxmanual.com>

<http://aubethermostatmanual.com>

Golf course search by state

<http://golfingnear.com>

Email search by domain

<http://emailbydomain.com>

Auto manuals search

<http://auto.somanuals.com>

TV manuals search

<http://tv.somanuals.com>