

# BLACK+ DECKER™

## AIRSWIVEL™ ULTRA LIGHT WEIGHT UPRIGHT VACUUM CLEANER

### INSTRUCTION MANUAL

#### MODEL NUMBER

**BDASP101**

**BDASP102**

**BDASP103**

**BDASP201**

**BDASP202**

**BDASP303**

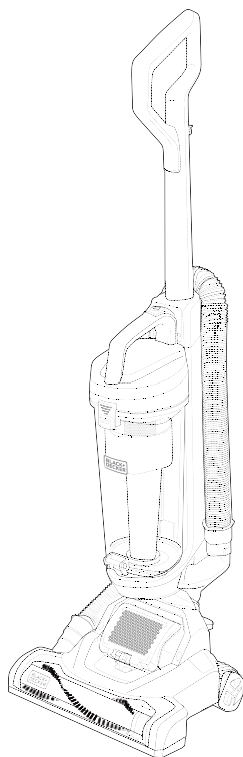

Thank you for choosing BLACK+DECKER!

**PLEASE READ BEFORE RETURNING THIS PRODUCT FOR ANY REASON.**

If you have a question or experience a problem with your BLACK+DECKER purchase, go to <http://www.blackanddecker.com>.

If you can't find the answer or do not have access to the Internet, call 1-800-524-6716 from 9 a.m. to 5 p.m. EST Mon. - Fri. to speak with an agent. Please have the model number available when you call.

**SAVE THIS MANUAL FOR FUTURE REFERENCE.**

To register your new product, visit  
[www.BlackandDecker.com](http://www.BlackandDecker.com)

# IMPORTANT SAFETY INSTRUCTION

## SAFETY GUIDELINES - DEFINITIONS

It is important for you to read and understand this manual.

The information it contains relates to protecting YOUR SAFETY and PREVENTING PROBLEMS. The symbols below are used to help you recognize this information.

⚠ **DANGER:** Indicates an imminently hazardous situation which, if not avoided, will result in death or serious injury.

⚠ **WARNING:** Indicates a potentially hazardous situation which, if not avoided, could result in death or serious injury.

⚠ **CAUTION:** Indicates a potentially hazardous situation which, if not avoided, may result in minor or moderate injury.

**NOTICE:** Used without the safety alert symbol indicates potentially hazardous situation which, if not avoided, may result in property damage.

When using an electrical appliances, basic precautions should always be followed, including the following:

## READ ALL INSTRUCTIONS BEFORE USING THE APPLIANCE.

⚠ **WARNINGS:** Before using this appliance, read and follow all warnings and instructions in this manual, even if you are familiar with this product.

This appliance is not intended for use by persons (including children) with reduced physical, sensory or mental capabilities, or lack of experience and knowledge, unless they have been given supervision or instruction concerning use of the appliance by a person responsible for their safety.

Young children should be supervised to ensure that they do not play with the appliance.

## Safety Direction

Please read this instruction manual carefully before first use. It is advisable to keep this instruction manual for future reference.

**DO NOT** vacuum water, wet objects, liquids, ashes, hot coals, cigarette butts, matches or any hot, smoking or burning objects, etc.

**DO NOT** pick up flammable or combustible materials (i.e. lighter fluid, petrol, kerosene, etc.) or use in the presence of explosive liquids or vapor.

**DO NOT** pick up toxic material (i.e. chlorine bleach, ammonia, drain cleaner, etc.)

**DO NOT** vacuum Toner (for laser printer, copy machines etc.) as there is a risk of fire and explosion.

**DO NOT** vacuum plaster, cement etc. as the filter can become blocked.

**DO NOT** use the vacuum without all the filters fitted.

**DO NOT** store or use the appliance near high temperature areas.

**DO NOT** run over the power cord with the vacuum cleaner.

**DO NOT** use the vacuum cleaner if it is blocked. Turn off and clear all blockages before continuing.

**DO NOT** use the vacuum cleaner with blocked filters. Clean or replace filters before continuing. (refer to User Maintenance section).

**DO NOT** use the vacuum cleaner if the appliance malfunctions, abnormal noise, smell, smoke, is dropped or damaged in any manner or any breakage is found during operation.

**DO NOT** misuse the cord. Never pull the appliance by the cord or pull to disconnect it from the outlet. Instead, grasp the plug and pull to disconnect.

**DO NOT** use the vacuum cleaner to pick up large objects, hard or sharp objects such as glass, nails, screws, coins, etc. that are likely to cause damage.

**DO NOT** Leave Unattended when plugged in and/or switched on.

**DO NOT** use vacuum cleaner if it has been dropped, damaged, left outdoors, or dropped into liquid (water etc.)

**DO NOT** close door on cord, or pull cord around sharp edges or corners.

**DO NOT** handle the plug or vacuum cleaner with wet hands.

**DO NOT** put any objects into openings.

**DO NOT** use with any openings blocked and do not restrict airflow.

**DO NOT** operate the appliance with a damaged cord or plug. If the supply cord is damaged, it must be replaced by the manufacturer, its service agent or similarly qualified persons in order to avoid a hazard.

**DO NOT** use without filters in place.

**DO NOT** attempt to modify this product in any way.

**DO** empty the Dust Canister and clean the filters regularly for optimal operation of the vacuum.

**DO** keep hair, loose clothing, fingers, feet and body parts away from openings or moving parts.

**DO** disconnect the appliance from the mains supply before connecting the flexible suction hose.

**DO** turn off controls before you connect or disconnect the appliance to or from the mains supply.

**DO disconnect the appliance from the power supply when not in use, before** changing the filters, cleaning the filters or connecting / disconnecting the accessories.

**DO** use only on dry, indoor surfaces.

**DO** use only as described in this manual. Use only manufacturer's recommended attachments.

**DO** Keep cord away from heated surfaces.

**DO** Keep all openings free of dust, lint, hair, and anything that may reduce airflow.

**DO** use extra care when vacuuming on stairs.

**DO** keep your work area well lit.

**DO** store your appliance indoors in a cool, dry area.

**DO** ensure children and babies cannot play with plastic bags or any packaging materials.

**DO** operate the appliance from a power source of the same voltage, frequency and rating as indicated on the product identification plate.

If this appliance is used by a third party,

**DO** supply the instruction manual with it. No liability can be accepted for any damage caused by non-compliance with these instructions or any other improper use or mishandling of appliance.

This product has not been designed for any uses other than those specified in this manual.

**DO NOT** modify the polarized plug to fit a non - polarized outlet or extension cord.

**Keep appliance on a level surface.**

**ONLY** for domestic use.

Industrial or commercial use invalidates the warranty.

# IMPORTANT SAFETY INSTRUCTION CONT.

## READ AND SAVE THESE INSTRUCTIONS

### Symbols

- The label on your tool may include the following symbols.

The symbols and their definitions are as follows:

V.....volts

A.....amperes

Hz.....hertz

W.....watts

min .....minutes

~ or AC.....alternating current

— or DC....direct current

$n_o$ .....no load speed

Ⓡ .....Class I Construction

Ⓢ .....earthing terminal  
(grounded)

⚠ .....safety alert symbol

Ⓜ .....Class II Construction (double insulated)

.../min or rpm...revolutions or reciprocation per minute

- When using an extension cord, be sure to use one heavy enough to carry the current your product will draw. An undersized cord will cause a drop in line voltage resulting in loss of power and overheating.

The following table shows the correct size to use depending on cord length and nameplate ampere rating. If in doubt, use the next heavier gauge. The smaller the gauge number, the heavier the cord.

Volts	Minimum Gauge for Cord Sets Total Length of Cord in Feet				
	120V	0-25 (0-7,6m)	26-50 (7,6-15,2m)	51-100 (15,2-30,4m)	101-150 (30,4-45,7m)
240V	0-50 (0-15,2m)	51-100 (15,2-30,4m)	101-200 (30,4-60,9m)	201-300 (60,9-91,4m)	
Ampere Rating					
More Than	Not more Than	American Wire Gauge			
0	6	18	16	16	14
6	10	18	16	14	12
10	12	16	16	14	12
12	16	14	12	Not Recommended	

### Transporting your Vacuum

To move your vacuum cleaner from room to room, unplug the unit and either push the appliance or carry using the carry handle.

Never pull or carry the vacuum cleaner by its cord.

Never carry or pull the vacuum cleaner by the flexible hose.

## Product View

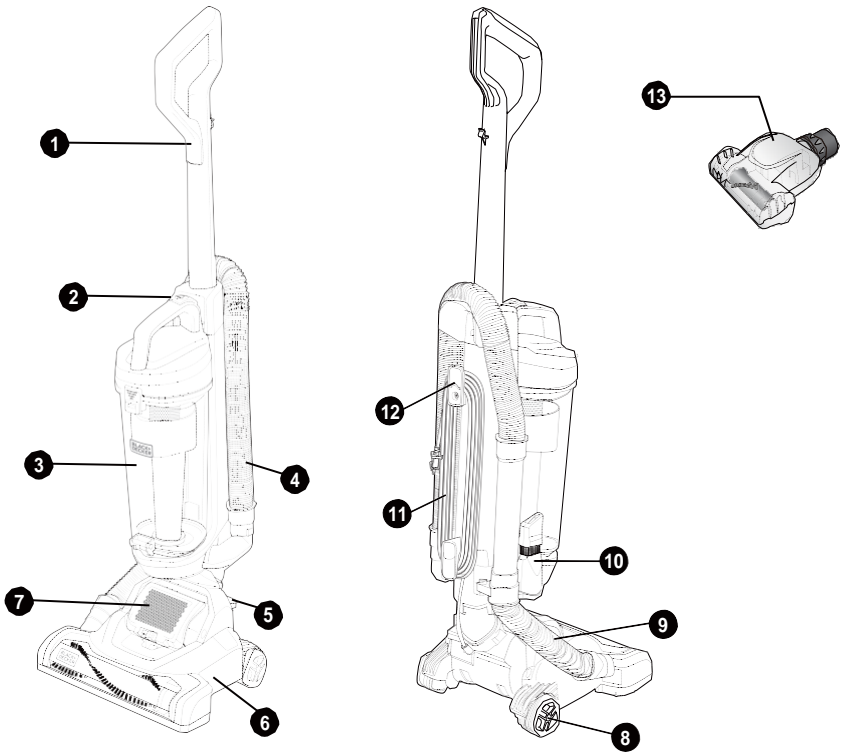

1. Handle
2. Dust cup release
3. Dust cup
4. Handle hose
5. Power on/off
6. Nozzle
7. Air outlet

8. Wheel
9. Connecting hose
10. 2-in-1 crevice tool accessory
11. Power cord
12. Power cord wrap
13. Turbo Pet Tool accessory

The pet hair cleaning tool (13) is for use when vacuuming pet hair and/or ground-in debris from carpeted or upholstery surfaces.

**⚠ WARNING:** Injury to pets. Do not use pet hair cleaning tool directly on animals.

## Assembly

**Please Note:** Always remove the plug from the power socket before fitting or removing accessories. Ensure all Filters are fitted, and fitted correctly before using.

**⚠ WARNING:** DO NOT plug in your vacuum cleaner until you have completely assembled it per the following instructions and are familiar with all instructions and operation procedures.

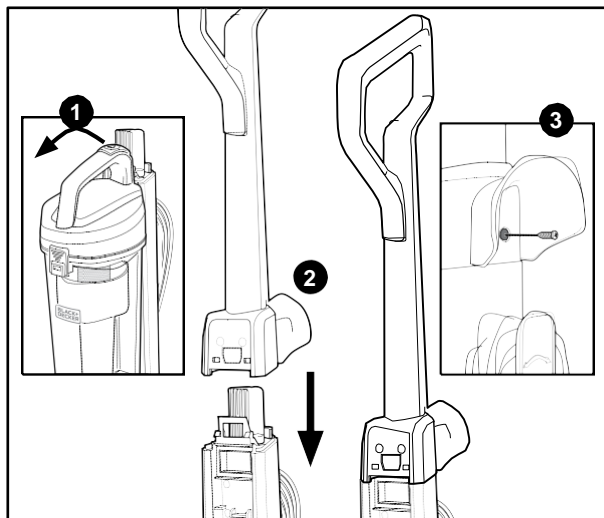

Remove the dust cup before installing handle.  
Insert the handle into the vacuum body, then rotate the screw into body as shown. **IMPORTANT:** The handle must be inserted first before re-placing the dust cup.

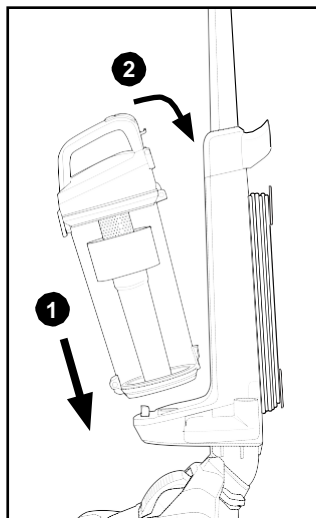

Place the dust cup back onto the machine and push until it clicks into place.

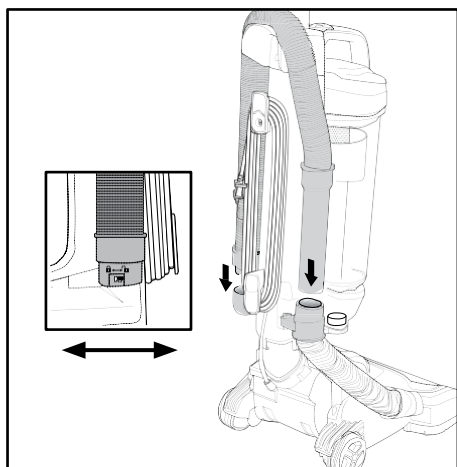

Insert the handle hose end into the connector hose and rotate clockwise to join. Then insert the handle into the other hose of the body.

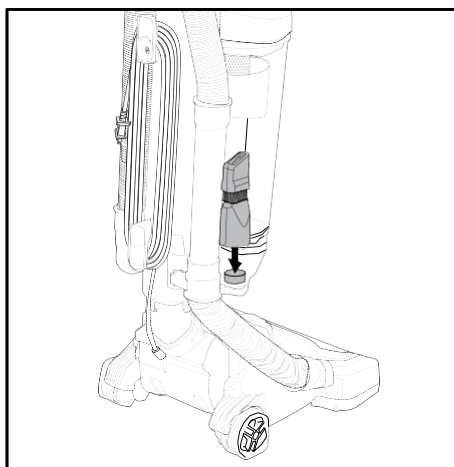

Insert the 2-in-1 crevice tool accessory into the on-board storage reservoir, as shown.

## Operation

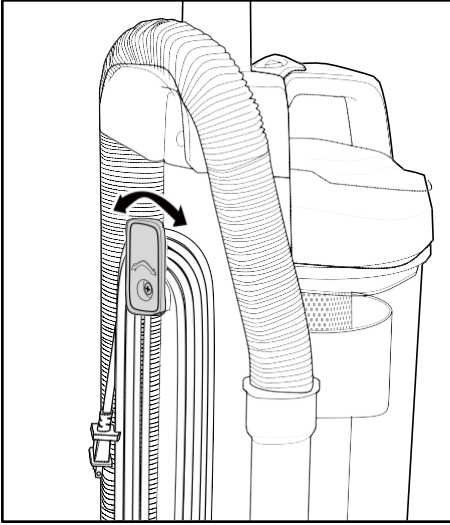

Twist the quick release cord hook to release the power cord.

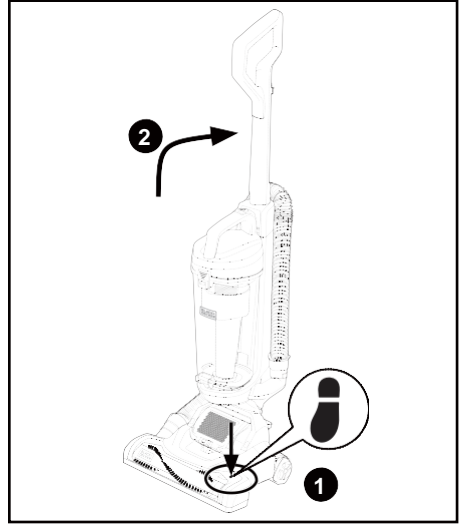

Step on the brush cover and pull back on handle, to engage for operation.

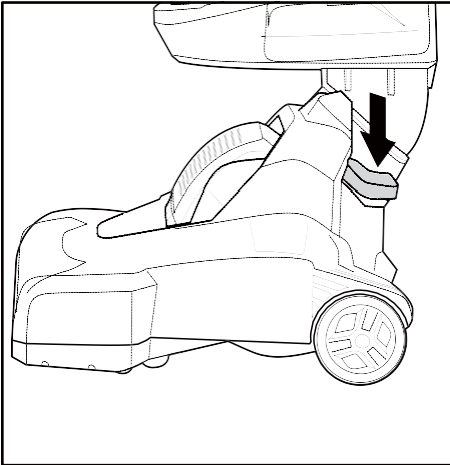

Plug in your machine and push ON/OFF button to switch ON/OFF.

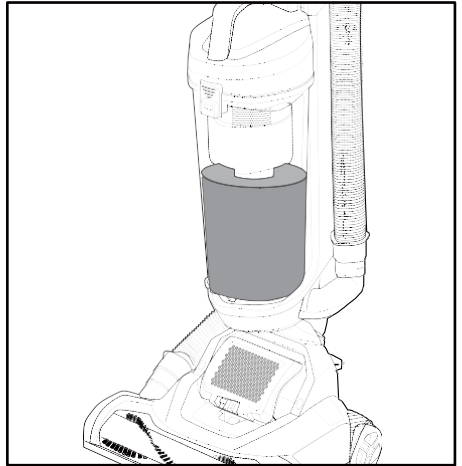

To maintain optimal performance, please empty dust cup when debris reaches MAX FILL line.

## Operation

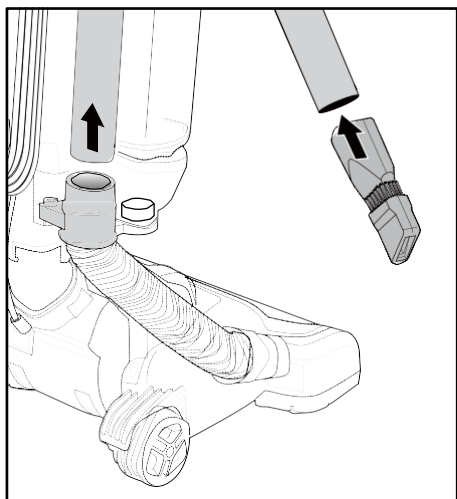

Remove hose handle and 2-in-1 crevice tool accessory from the machine.

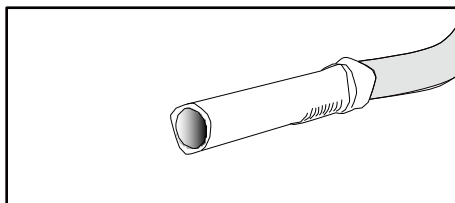

The handle hose can be used immediately.

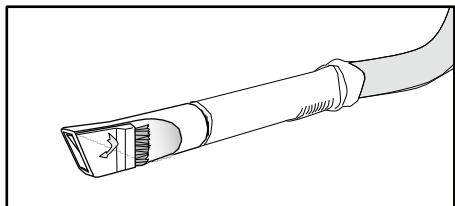

At the same time, you can insert the 2-in-1 crevice tool into the hose handle to extend the distance.

## Accessories

### 2-in-1 Crevice Tool Accessory

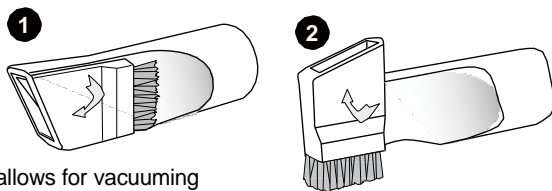

The 2-in-1 crevice tool with brush allows for vacuuming in narrow and hard-to-reach places.

### TURBO Pet Tool

For vacuuming pet hair of all surface.

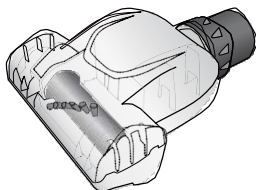



## Maintenance And Care - Emptying

**⚠WARNING:** Turn off and unplug vacuum cleaner before performing maintenance to the vacuum cleaner.

### Emptying and cleaning the dust cup

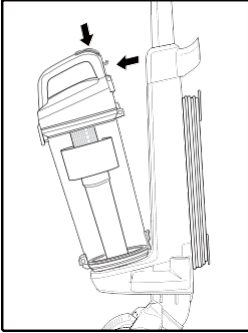

Press dust cup release button to remove the dust cup.

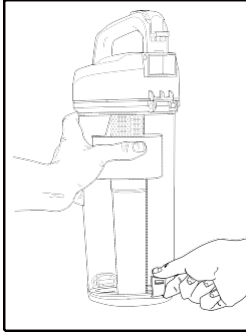

Hold dust cup over garbage bin and unclip the lock on the bottom of the cup, allowing the dust to empty.

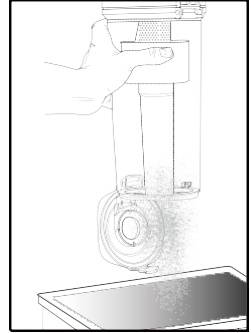

Close the base of the dust cup, align the cup base back onto the machine and push until it clicks back into place.

## Maintenance And Care - Cleaning Exhaust Filter

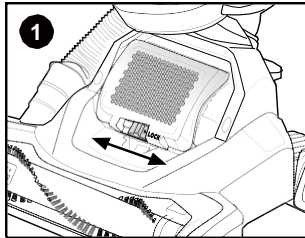

Locate and unlock filter cover as shown. Push left to un-lock, right to lock.

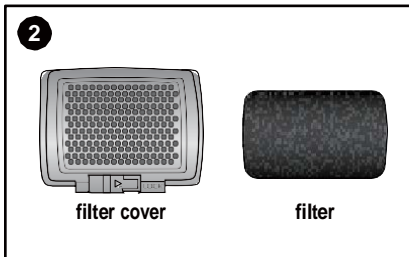

Remove filter cover with filter. Wipe with cloth over garbage bin, removing dirt and debris.

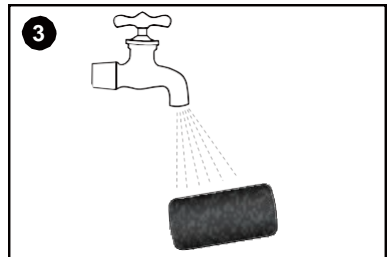

Wash with water every 3 months, allow at least 24 hours to dry and make sure it is dry thoroughly before re-using.

## Maintenance And Care - Cleaning Dust Cup Filter

**⚠ WARNING:** Turn off and unplug vacuum cleaner before performing maintenance to the vacuum cleaner.

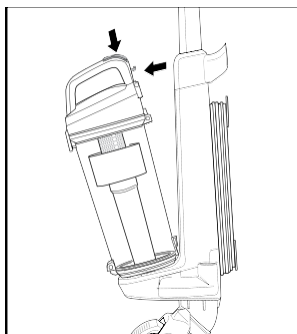

1. Remove the dust cup.

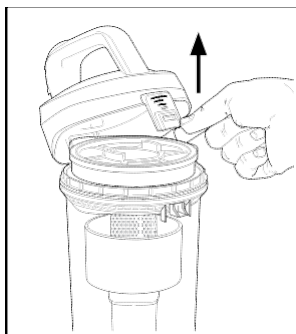

2. Open the dust cup filter lid, located on the top of the cup.

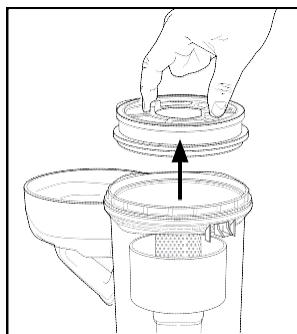

3. Remove the dust cup foam filter.

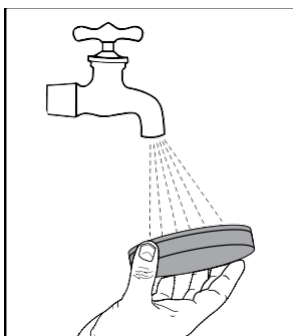

4. Hand wash the foam filter.



5. Allow filter to dry 24 hours before putting back into vacuum cleaner.

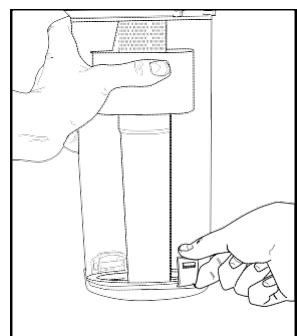

6. Push the release button, open the dust cup and clean all parts of the dust cup.

**DO NOT** operate without filter installed.

**DO NOT** wash dust cup in the dishwasher.

**DO NOT** install filter damp.

**⚠ CAUTION:** Do not turn appliance on when dust cup is removed.

- In order to keep the suction force optimized, the dust cup and filters must be cleaned regularly.
- Reassemble after cleaning

## Maintenance And Care - Cleaning Brush Roll

**⚠ WARNING:** Turn off and unplug vacuum cleaner before performing maintenance to the vacuum cleaner.

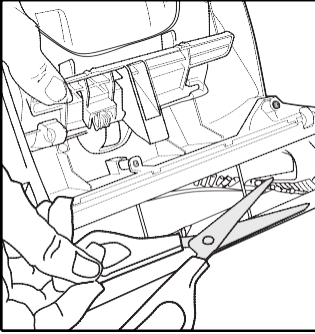

Carefully remove any string, hair or debris located on the brush roll.

You can use a tool such as a small knife or scissors to remove and cut any hair or string.

## Maintenance And Care - Cleaning Pet Tool

**⚠ WARNING:** Turn off and unplug vacuum cleaner before performing maintenance to the vacuum cleaner.

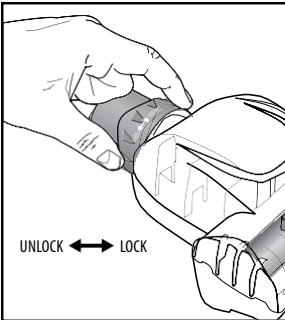

1. To release the pet tool plastic upper cap for internal cleaning, rotate, unlock and remove the plastic locking ring as shown.

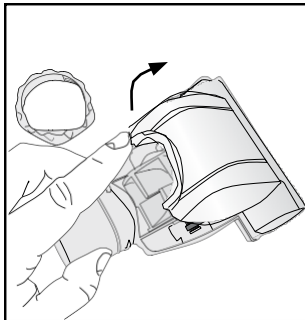

2. Pull up on the plastic upper cap of the pet tool as shown.

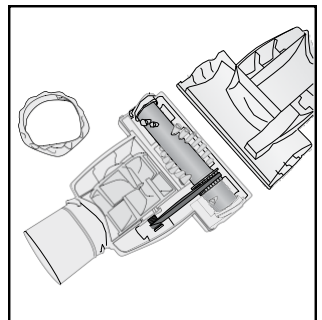

3. Remove plastic upper cap and clean, removing pet hair and debris.

## Maintenance And Care - Cleaning Vacuum And Tools

Do not clean the vacuum cleaner, components or accessories using petrol or any other flammable liquid or solvents, etc.

Clean only the outside of the vacuum cleaner.

Use only a moist cloth and mild detergent for cleaning the vacuum cleaner, components and accessories.

After cleaning, wipe off the moisture on vacuum cleaner, components and accessories with a dry cloth.

**Do Not** place accessories, tools or components in a dishwasher.

## Maintenance And Care - Replace Brush Roll

**⚠ WARNING:** Turn off and unplug vacuum cleaner before performing maintenance to the vacuum cleaner.

You should check your cleaner's brush roll and drive belt regularly for wear or damage. You should also clean the brush and brush ends by removing string, hair and carpet fibers. These can wrap around the brush and hamper its ability to effectively clean your carpet. Also remove any debris that has accumulated under the brush cover.

1. Turn off vacuum and unplug from electrical outlet.
2. Place vacuum upside down with brush roll facing upwards.
3. Remove the six screws as shown with a small Phillips screwdriver.
4. Lift off brush cover.
5. Grasp floor brush at both ends and remove by lifting out.
6. Clean string, hair and other debris from floor brush, motor pulley, and drive belt.
7. Check floor brush for worn areas and replace if needed.
8. Check air passageway for obstructions. Remove debris from this area.
9. When finished cleaning, reposition floor brush and drive belt.  
Then replace the brush cover and re-install the five screws.
10. Turn floor brush by hand several times in the direction of the motor pulley.  
If properly installed, the drive belt will align itself on floor brush.

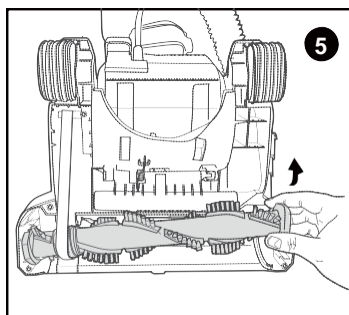
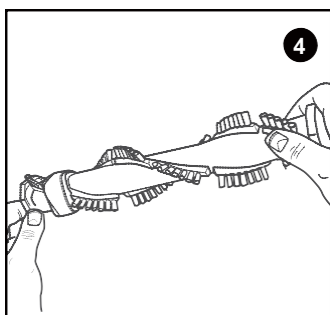
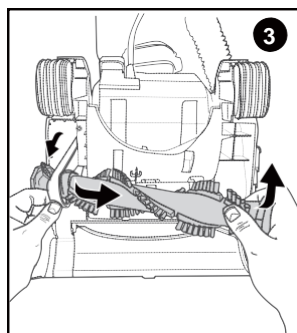
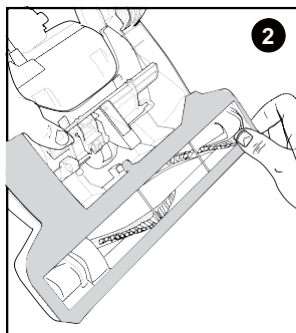
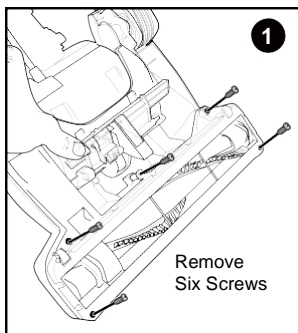

## Troubleshooting

**⚠ WARNING:** To reduce the risk of electric shock, turn power OFF and disconnect plug from electrical outlet before performing maintenance or troubleshooting to the vacuum cleaner.

Vacuum cleaner won't run: Possible causes	Remedies
<ol style="list-style-type: none"> <li>1. Vacuum cleaner is not plugged in</li> <li>2. Blown fuse/tripped breaker</li> </ol>	<ol style="list-style-type: none"> <li>1. Check electrical plug</li> <li>2. Check/replace fuse or reset breaker</li> </ol>
Vacuum cleaner won't pick up dirt: Possible causes	Remedies
<ol style="list-style-type: none"> <li>1. Dust cup is full</li> <li>2. Filter is dirty</li> <li>3. Hose not secure</li> <li>4. Dust cup not in place</li> <li>5. Vacuum path clogged</li> </ol>	<ol style="list-style-type: none"> <li>1. Empty dust cup</li> <li>2. Check, remove debris or clean</li> <li>3. Check to be sure hose is snapped into place at both ends</li> <li>4. Make sure dust cup is fully inserted and dust cup release handle is pushed in completely</li> <li>5. Visually check air passageway, hose inlet, and hose for anything that might be obstructing the vacuum path. Carefully remove blockage</li> </ol>

## Replacement Parts

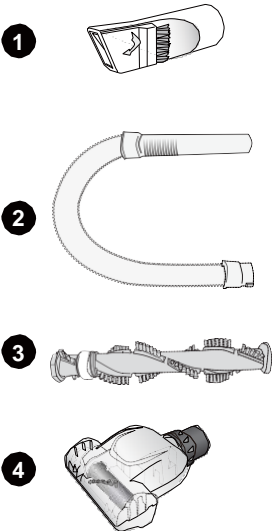

Item	Name	Part No.	Color
1	2 in 1 Crevice Tool	L0101	Black
		L0102	Cool Grey 4C
2	Hose	L0301	Black
		L0302	Cool Grey 4C
3	Brush Roll	L0401	Blue
		L0402	Red
4	Pet Tool	P0501	Blue
		P0502	Red

Other maintenance or service not included in the manual should be performed by an authorized service representative. Thank you for selecting a BLACK& DECKER product.

Please do not return this product to the store

For any questions or concerns, BLACK&DECKER is happy to be of service.  
Contact us directly at 1-800 524-6716

# WARRANTY

## ONE-YEAR LIMITED WARRANTY

Black & Decker (U.S.) Inc. warrants this product to be free from defects in material or workmanship for a period of one (1) year following the date of purchase, provided that the product is used in a home environment. This limited warranty does not cover failures due to abuse, accidental damage or when repairs have been made or attempted by anyone other than BLACK+DECKER authorized service agent. A defective product meeting the warranty conditions set forth herein will be replaced or repaired at no charge in either of two ways:

The first, which will result in exchanges only, is to return the product to the retailer from whom it was purchased (provided that the store is a participating retailer). Returns should be made within the time period of the retailer's policy for exchanges. Proof of purchase may be required. Please check with the retailer for its specific return policy regarding time limits for returns or exchanges.

The second option is to take or send the product (prepaid) to a BLACK+DECKER authorized Service Agent for

repair or replacement at BLACK+DECKER's option. Proof of purchase may be required. This warranty does not apply to accessories. This warranty gives you specific legal rights and you may have other rights which vary from state to state. Should you have any questions, please call customer service at **1-800-524-6716**.

This product is not intended for commercial use, and accordingly, such commercial use of this product will void this warranty. All other guarantees, express or implied, are hereby disclaimed.

For assistance with your product, visit our website **[www.blackanddecker.com](http://www.blackanddecker.com)** or call the BLACK+DECKER help line at **1-800-524-6716**

Imported By  
Midea USA, Inc.  
5 Sylvan Way Parsippany,  
NJ 07054, USA



## Free Manuals Download Website

<http://myh66.com>

<http://usermanuals.us>

<http://www.somanuals.com>

<http://www.4manuals.cc>

<http://www.manual-lib.com>

<http://www.404manual.com>

<http://www.luxmanual.com>

<http://aubethermostatmanual.com>

Golf course search by state

<http://golfingnear.com>

Email search by domain

<http://emailbydomain.com>

Auto manuals search

<http://auto.somanuals.com>

TV manuals search

<http://tv.somanuals.com>