



SOLUTIONS FOR ALL YOUR APPLICATIONS

**Stock No.
5800
USER MANUAL**

BIDA Series

Broadband Indoor Distribution Amplifiers - Active Return Path

Model	Stock No.	Model	Stock No.
BIDA 55A-30	5800 53	BIDA 86A-30	5800 83
BIDA 55A-30P	5800P53	BIDA 86A-30P	5800P83
BIDA 55A-43	5800 54	BIDA 86A-43	5800 84
BIDA 55A-43P	5800P54	BIDA 86A-43P	5800P84
BIDA 55A-50	5800 55	BIDA 100A-30	5800 13
BIDA 75A-30	5800 73	BIDA 100A-30P	5800P13
BIDA 75A-30P	5800P73	BIDA 100A-43	5800 14
BIDA 75A-43	5800 74	BIDA 100A-43P	5800P14
BIDA 75A-43P	5800P74		

Status	Date	Document No.	Issue No.	Author
ACTIVE	9/08/2014	651187000 P	1	KK

800-523-6049

www.blondertongue.com

Product Summary

Description

The Blonder Tongue BIDA-ARP is a completely self-contained broadband indoor distribution amplifier designed specifically for CATV and SMATV signal distribution systems which use a cable drop as a signal source. Seventeen models are available with bandwidths ranging from 49-550 MHz to 49-1000 MHz, gains of either 30 dB or 43 dB, and push-pull or power doubling hybrid technology.

All models have a return path bandwidth of 5-36 MHz and can be configured for either a passive (as shipped) or active return. When field configured to an active return the BIDA-ARP Series have a full gain of 20 dB. All models can be attenuated over a range of 10 dB in the forward path and 18 dB in the return path. Gain and slope controls are located on the front panel for easy set-up and adjustment. Two -30 dB backmatched test points are provided to permit testing without interruption of service.

In applications where input signals are too high or where greater cable equalization is necessary, the BIDA-ARP can be reconfigured by using plug-in fixed attenuators (forward and return) and cable slope equalizers (forward) to meet particular requirements.

Push-pull and power doubling hybrid modules, hybrid IC modules enable the BIDA-ARP to operate at high output levels while retaining low distortion characteristics.

The aluminum chassis is designed to provide excellent heat dissipation thus allowing operation at high ambient temperatures with no degradation of performance or reliability.

Features

- Provides Two-Way Capability with an Active or Passive Return Path Set by Field-Changeable Jumpers.
- Hybrid IC Circuitry for High Output with Low Distortion.
- Front Panel Gain and Slope Controls for Easy Adjustments.
- Sockets for Hybrid IC to Make a Hybrid IC Change in the Field.
- Forward Path Input-Side Plug-In Fixed Attenuator and Cable Equalizer for Optimum Performance.
- Return Path Output-Side Fixed Attenuator for Optimum Performance.
- Externally Accessible Test Points Permit In-Service Testing.
- Exceeds FCC Specs for Both Conducted and Radiated Interference at Full Output Level.
- External "UL Listed" Power Transformer.



Section 1 — General & Safety Instructions



The STOP sign symbol is intended to alert you to the presence of REQUIRED operating and maintenance (servicing) instructions that if not followed, may result in product failure or destruction.



The YIELD sign symbol is intended to alert you to the presence of RECOMMENDED operating and maintenance (servicing) instructions.



The LIGHTNING flash symbol is intended to alert you to the presence of uninsulated "dangerous voltage" within the product's enclosure that may be of sufficient magnitude to constitute a risk of electrical shock.

**TO REDUCE THE RISK OF ELECTRICAL SHOCK, DO NOT REMOVE COVER FROM THIS UNIT.
 NO USER-SERVICEABLE PARTS INSIDE. REFER SERVICING TO QUALIFIED SERVICE PERSONNEL.**

WARNING: TO PREVENT FIRE OR SHOCK HAZARD, DO NOT EXPOSE THIS UNIT TO RAIN OR MOISTURE

NOTE TO CATV SYSTEM INSTALLER

This reminder is provided to call the CATV System Installer's attention to Article 820-40 of the NEC that provides guidelines for proper grounding and, in particular, specifies that the cable ground shall be connected to the grounding system of the building, as close to the point of cable entry as practical.

Safety Instructions



**YOU SHOULD ALWAYS FOLLOW THESE INSTRUCTIONS TO HELP ENSURE
 AGAINST INJURY TO YOURSELF AND DAMAGE TO YOUR EQUIPMENT.**

- Elevated Operating Ambient - If installed in a closed or multi-unit rack assembly, the operating ambient temperature of the rack environment may be greater than room ambient. Therefore, consideration should be given to installing the equipment in an environment compatible with the maximum ambient temperature.
- Reduced Air Flow - Installation of the equipment in a rack should be such that the amount of air flow required for safe operation of the equipment is not compromised.
- Mechanical Loading - Mounting of the equipment in the rack should be such that a hazardous condition is not achieved due to uneven mechanical loading.
- Circuit Overloading - Consideration should be given to the connection of the equipment to the supply circuit and the effect that overloading of the circuits might have on overcurrent protection and supply wiring. Appropriate consideration of equipment nameplate ratings should be used when addressing this concern.
- Reliable Earthing - Reliable earthing of rack-mounted equipment should be maintained. Particular attention should be given to supply connections other than direct connections to the branch circuit (e.g. use of power strips).
- Read all safety and operating instructions before you operate the unit.
- Retain all safety and operating instructions for future reference.
- Heed all warnings on the unit and in the safety and operating instructions.

Safety Instructions - continued

- Follow all installation, operating, and use instructions.
- Unplug the unit from the AC power outlet before cleaning. Use only a damp cloth for cleaning the exterior of the unit.
- Do not use accessories or attachments not recommended by Blonder Tongue, as they may cause hazards, and will void the warranty.
- Do not operate the unit in high-humidity areas, or expose it to water or moisture.
- Do not place the unit on an unstable cart, stand, tripod, bracket, or table. The unit may fall, causing serious personal injury and damage to the unit.
- Do not block or cover slots and openings in the unit. These are provided for ventilation and protection from overheating. Never place the unit near or over a radiator or heat register. Do not place the unit in an enclosure such as a cabinet without proper ventilation. Do not mount equipment in the rack space directly above or below the unit.
- Operate the unit using only the type of power source indicated on the marking label. Unplug the unit power cord by gripping the plug, not the cord.
- The unit is equipped with a three-wire ground-type plug. This plug will fit only into a ground-type power outlet. If you are unable to insert the plug into the outlet, contact an electrician to replace the outlet. Do not defeat the safety purpose of the ground-type plug.
- Route power supply cords so that they are not likely to be walked on or pinched by items placed upon or against them. Pay particular attention to cords at plugs, convenience receptacles, and the point where they exit from the unit.
- Be sure that the outdoor components of the antenna system are grounded in accordance with local, federal, and National Electrical Code (NEC) requirements. Pay special attention to NEC Sections 810 and 820. See the example shown in the following diagram:

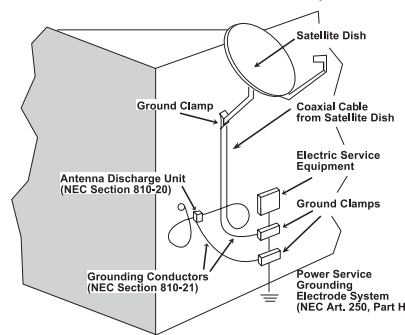

- We strongly recommend using an outlet that contains surge suppression or ground fault protection. For added protection during a lightning storm, or when the unit is left unattended and unused for long periods of time, unplug it from the wall outlet and disconnect the lines between the unit and the antenna. This will prevent damage caused by lightning or power line surges.
- Do not locate the antenna near overhead power lines or other electric light or power circuits, or where it can fall into such power lines or circuits. When installing the antenna, take extreme care to avoid touching such power lines or circuits, as contact with them can be fatal.
- Do not overload wall outlets or extension cords, as this can result in a risk of fire or electrical shock.
- Never insert objects of any kind into the unit through openings, as the objects may touch dangerous voltage points or short out parts. This could cause fire or electrical shock.
- Do not attempt to service the unit yourself, as opening or removing covers may expose you to dangerous voltage and will void the warranty. Refer all servicing to authorized service personnel.
- Unplug the unit from the wall outlet and refer servicing to authorized service personnel whenever the following occurs:
 - The power supply cord or plug is damaged;
 - Liquid has been spilled, or objects have fallen into the unit;
 - The unit has been exposed to rain or water;
 - The unit has been dropped or the chassis has been damaged;
 - The unit exhibits a distinct change in performance.
- When replacement parts are required, ensure that the service technician uses replacement parts specified by Blonder Tongue. Unauthorized substitutions may damage the unit or cause electrical shock or fire, and will void the warranty.
- Upon completion of any service or repair to the unit, ask the service technician to perform safety checks to ensure that the unit is in proper operating condition.

Returning Product for Repair (or Credit)

A Return Material Authorization (RMA) Number is required on all products returned to Blonder Tongue, regardless if the product is being returned for repair or credit. Before returning product, please contact the Blonder Tongue Service Department at 1-800-523-6049, Ext. 4256 or visit our website: www.blondertongue.com for further information.

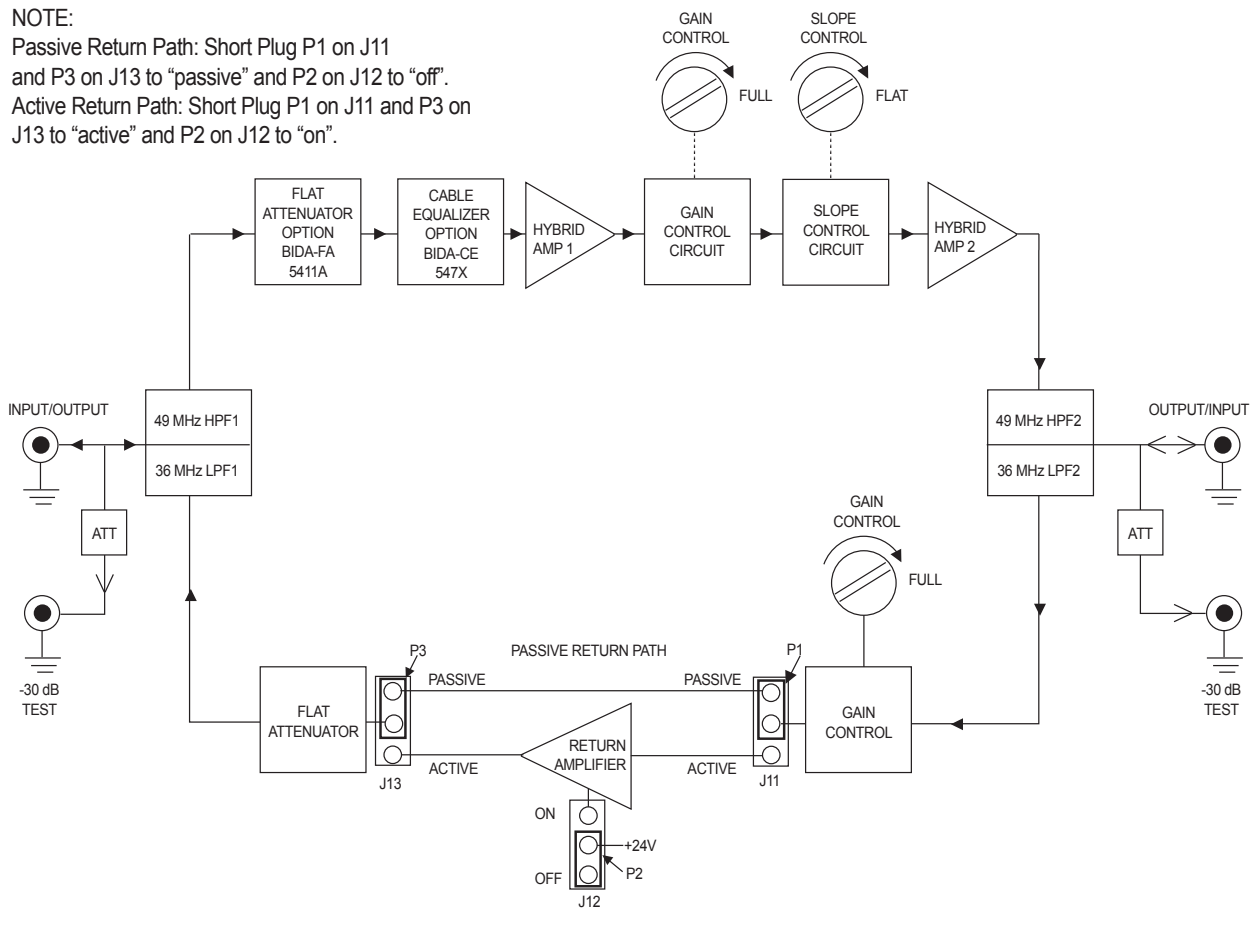

Figure 1

Specifications

Model: BIDA-ARP Stock No:	55A-30 5800-53	55A-30P 5800P53	55A-43 5800-54	55A-43P 5800P54	55A-50 5800-55	75A-30 5800-73	75A-30P 5800P73	75A-43 5800-74	75A-43P 5800P74	86A-30 5800-83	86A-30P 5800P83	86A-43 5800-84	86A-43P 5800P84	100A-30 5800-13	100A-30P 5800P13	100A-43 5800-14	100A-43P 5800P14	Integrated Active Return Path
Frequency Range:	49-550 MHz																	
Gain:	30 dB	30 dB	43 dB	43 dB	50 dB	30 dB	30 dB	43 dB	43 dB	30 dB	30 dB	43 dB	43 dB	30 dB	30 dB	43 dB	43 dB	20 dB
Flatness:	±0.50 dB																	
Gain Control Range:	10 dB																	
Slope Control Range:	8 dB																	
Input Return Loss:	16 dB																	
Output Return Loss:	16 dB																	
Noise Figure:	7 dB	8.5 dB																
No. of Channels (for CSO, CTB, & XMD):	77																	
Output Level:	36/44 dBmV																	
Composite Triple Beat (CTB):	-64 dB	-71 dB	-63 dB	-68 dB	-63 dB	-60 dB	-64 dB	-56 dB	-64 dB	-54 dB	-62 dB	-56 dB	-60 dB	-59 dB	-70 dB	-65 dB	-70 dB	-60
Crossmodulation (XMOD):	-67 dB	-74 dB	-66 dB	-69 dB	-60 dB	-62 dB	-68 dB	-60 dB	-68 dB	-54 dB	-62 dB	-60 dB	-65 dB	-60 dB	-66 dB	-58 dB	-66 dB	-60
2nd Order Composite (CSO):	-61 dB	-65 dB	-60 dB	-58 dB	-65 dB	-61 dB	-59 dB	-61 dB	-57 dB	-61 dB	-59 dB	-59 dB	-59 dB	-59 dB	-69 dB	-63 dB	-69 dB	-60
Impedance:	75 Ω																	
Hum Modulation:	-70 dB																	
Input/Output Test Port Level:	-30 dB; ±2 dB																	
Input/Output Test Port Return Loss:	20 dB																	
Operating Temperature Range:	-20 to +60 °C																	
Power Requirements:	Wall Power Transformer 105-130 VAC, 60 Hz 0.38 AMP Max																	
Dimensions (LxWxH):	10.5" x 7.25" x 3.25" (26.4 cm x 18.42 cm x 8.26 cm)																	
Shipping Weight:	6 lbs (2.7kg)																	
Plug-in Accessories:	#5411A-(*)																	
1) Flat Attenuator: (1-20dB in 1dB steps)	#5477-(*)																	
2) Cable Equalizer: (3,6,9,12,15,18 dB)	#5475-(*)																	
	#5478-(*)																	
	#5479-(*)																	

(*) Specify dB § Reference to +1 dB tilt

**THERE ARE NO USER SERVICEABLE PARTS IN THIS UNIT.
 INFORMATION BELOW IS FOR QUALIFIED INSTALLATION PERSONNEL ONLY**

Field Installable Optional Modules.

Take care not to bend jack pins when plugging in modules - view orientation of pins through holes provided - pins are polarized to prevent wrong installation - see Location Diagram.

Leakage-current and/or resistance measurements should be made by service technician after repairs are completed to determine that exposed parts are acceptably insulated from the supply circuit.

BIDA-CE Cable Equalizer

- Stock No. 5475 (for BIDA 550 MHz) = BIDA CE-5-(*)
- Stock No. 5477 (for BIDA 750 MHz) = BIDA CE-7-(*)
- Stock No. 5478 (for BIDA 860 MHz) = BIDA CE-8-(*)
- Stock No. 5479 (for BIDA 1000 MHz) = BIDA CE-10-(*)

Plug-in cable equalizer for increasing forward slope in BIDA series amplifiers. The BIDA-CE provides attenuation that varies inversely with frequency to correct inherent tilt of coaxial cable used in distribution systems. A sheet metal cover is mounted over the circuitry to improve stability while preventing accidental detuning during shipping, handling, and installation. The BIDA-CE is available in fixed values of 3, 6, 9, 12, 15 and 18 dB. Before inserting, remove the factory installed "0 dB" jumper wire W2 (between J6 & J8). Loosen mounting screw and rotate Cable Equalizer clamp clockwise. After inserting Cable Equalizer, rotate Cable Equalizer clamp counter-clockwise so it lays atop the mounting tab. Tighten mounting screw to secure Cable Equalizer clamp position, (View A).

* Specify dB value.

Note: Refer to Fig.1 for reverse path information.

BIDA-FA-(*) Flat Attenuator

Stock No. 5411A

Plug-in flat attenuator pad for reducing forward and/or return gain in BIDA series amplifiers. The BIDA-FA is available in fixed values of 1-20 dB in 1 dB steps. Before inserting, remove the factory installed "0 dB" jumper wire W1 (between J3 & J5) for forward and W3 (between J14 & J16) for return.

* Specify dB value.

Note: The unit is shipped with 18 gauge jumpers which are not re-installable. Do not remove jumpers except when installing optional equipment modules.

Accessory Identification

For future reference, it is recommended that the type and value of the accessories installed in the BIDA be marked in the space provided on the front panel. The full sized reproduction may also be copied and used for that purpose.

Accessories Installed

Forward Attenuator	_____	dB
Forward Equalizer	_____	dB
Return Path Attenuator	_____	dB

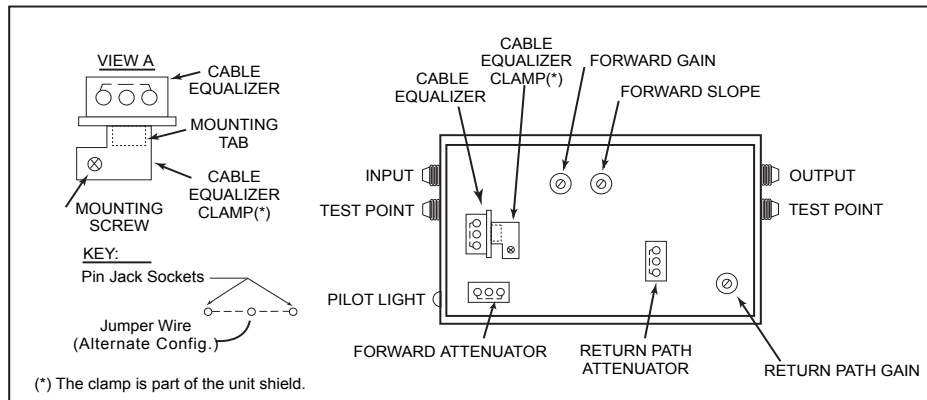

Figure 2 - Module and Control Location Diagram (Top View)

NOTES

NOTES

NOTES



Blonder
Tongue



SOLUTIONS FOR ALL YOUR APPLICATIONS

Encoders • EdgeQAM/IP • Transcoders • HD Solutions • OEM

Extended Warranty Program

STANDARD TERMS & CONDITIONS OF THE EXTENDED WARRANTY

A. THE EXTENDED WARRANTY AGREEMENT (EWA)

If during the period following the expiration of the Blonder Tongue Manufacturers' Standard Warranty (Copy Included) the products which constitute the subject matter of the extended warranty, manifest any manufacturing or similar such defects then Blonder Tongue shall at its option repair or replace the product. It is emphasized that the extended warranty is in effect an extension of the Blonder Tongue Warranty and covers the items stipulated in Paragraph B to the exclusion of the terms in Paragraph C of this agreement. Eligibility to purchase EW is limited to 90 days following initial shipment on selected products of sufficient value.

The product/products included in this extended warranty agreement are listed in the invoice that accompanies the EWA. Term of the extension will be _____ year(s). Purchase Order is required for extended warranty coverage.

B. WHAT IS COVERED?

1. If a product has been determined to have failed, which falls within the Terms & Conditions of this EWA, Blonder Tongue Inc. may at its sole discretion repair, modify or replace its component parts that are defective at 100% coverage for parts and labor.
2. A loaner unit may be available on request; PO required.
3. Product is manufactured by Blonder Tongue.
4. Extended warranty period is up to and not to exceed 24 months and sold in increments of 12 months. Order # 9981 for 1 year and #9982 for 2 year extensions.
5. Return of repair or replaced product shipping costs for ground shipments.
6. Firmware upgrades at no charge with automatic notification.

C. WHAT IS NOT COVERED?

1. The warranty does not cover any defects caused by foreign objects /connection errors .
2. Use other than by the customer at the declared address appearing in this document.
3. Failure by the end user to comply with the manufacturers' instructions for installation, maintenance or use.
4. The use of accessories which have not been approved by Blonder Tongue.
5. The application and/or use of any incorrect or abnormal electrical supply to the product.
6. Any defect in wiring or electrical connections which does not form part of the product at the time of the original purchase.
7. Neglect, misuse, or willful abuse of the product.
8. Any repairs or attempted repairs of the product by any person other than Blonder Tongue Service Department.
9. Any modification of the product by any person other than Blonder Tongue Service Department.
10. Fire, flood, war, civil disturbance, industrial action, acts of God or any other causes beyond the reasonable control of Blonder Tongue.
11. Any defect caused by lightning strike or power surges.
12. Shipping costs to return products to Blonder Tongue for warranty service.
13. Blonder Tongue will not in any circumstances be liable for any consequential loss or damages suffered by the customer whether directly or indirectly related defect in the product to the extent permissible by law.
14. Repairs may not be effected without prior authorization from Blonder Tongue Laboratories.

D. GENERAL

1. The customer shall notify Blonder Tongue Laboratories in writing within ten days of any change of his or her address.
2. Customer must provide original ***purchase receipt*** and ***serial number*** to initiate extended warranty coverage.
3. The fee paid for the warranty is not refundable under any circumstances unless cancelled within seven days of purchase.
4. The customer shall take all reasonable precautions to maintain the product is maintained in good working order.
5. The warranty contract ceases to exist if the product is replaced or a credit is given to the customer. Any monies paid for the warranty contract are forfeited and not refundable. This is only applicable when the product is out of the manufacturer's warranty.
6. The extended warranty period as stated on the Extended Warranty Agreement shall be the governing period notwithstanding any additional supplier warranty on specific components.
7. The warranty shall in no way effect the terms and conditions of the sale agreement in terms of which the customer bought the product.
8. The extended warranty is limited to the terms and conditions herein contained
9. No agreement, varying, adding to, amended, deleting, or cancelling this warranty shall be effective unless given in writing (email is acceptable) and signed by or on behalf of both parties.
10. The cost of the extended warranty is 8% of the purchase price for a 1 or 2 year extension beyond the Blonder Tongue standard warranty. e.g. A product price of \$1000 will be \$80 for the 1st year (12 mos) and additional \$80 for 2 year (24 mos) extension for a total of \$160.
11. Warranty product return postage paid to: Blonder Tongue Laboratories, Inc.

Attn: Warranty Service Dept.
1 Jake Brown Road
Old Bridge, NJ 08857

Contact Blonder Tongue at 800-523-6049 ext. 555 to order extended warranty service.

Limited Warranty

Seller will at its sole option, either repair or replace (with a new or factory reconditioned product, as Seller may determine) any product manufactured or sold (or in the case of software, licensed) by Seller which is defective in materials or workmanship or fails to meet the applicable specifications that are in effect on the date of shipment or such other specifications as may have been expressly agreed upon in writing: (i) for a period of three (3) years from the date of original purchase for all stock hardware products (other than those specifically referenced herein below having a shorter warranty period); (ii) for a period of one (1) year from the date of original purchase, with respect to all MegaPort™, IPTV products, test equipment and fiber optics receivers, transmitters, couplers and integrated receiver/distribution amplifiers; (iii) for a period of one (1) year from the date of original purchase (or such shorter period of time as may be set forth in the license agreement specific to the particular software being licensed from Seller) with respect to all software products licensed from Seller (other than Core Product Software) that is (a) developed for a specific function or application, (b) complimentary to and does not function without the Core Product Software, and (c) listed with a specific model number and stock number in Seller's Price List ("**Non-Core Software**"); (iv) for a period of ninety (90) days from the date of original purchase, with respect to non-serialized products and accessories, such as parts, sub-assemblies, splitters and all other products sold by Seller (other than Core Product Software and Refurbished/Closeout Products) not otherwise referred to in clauses (i) through (iii) above. The warranty period for computer programs in machine-readable form included in a hardware product, which are essential for the functionality thereof as specifically stated in the published product specifications ("**Core Product Software**") will be coincident with the warranty period of the applicable hardware product within which such Core Product Software is installed.

Software patches, bug fixes, updates or workarounds do not extend the original warranty period of any Core Product Software or Non-Core Software.

Notwithstanding anything herein to the contrary,

(i) Seller's sole obligation for software that when properly installed and used does not substantially conform to the published specifications in effect when the software is first shipped by Seller, is to use commercially reasonable efforts to correct any reproducible material non-conformity (as determined by Seller in its sole discretion) by providing the customer with: (a) telephone or e-mail access to report non-conformance so that Seller can verify reproducibility, (b) a software patch or bug fix, if available or a workaround to bypass the issue if available, and (c) where applicable, replacement or damaged or defective external media, such as CD-ROM disk, on which the software was originally delivered;

(ii) Seller does not warrant that the use of any software will be uninterrupted, error-free, free of security vulnerabilities or that the software will meet the customer's particular requirements; and the customer's sole and exclusive remedy for breach of this warranty is, at Seller's option, to receive (a) suitably modified software, or part thereof, or (b) comparable replacement software or part thereof;

(iii) Seller retains all right, title and interest in and to and ownership of all software (including all Core Product Software and Non-Core Software) including any and all enhancements, modifications and updates to the same; and

(iv) in some cases, the warranty on certain proprietary sub-assembly modules manufactured by third-party vendors and contained in Seller's products, third party software installed in certain of Seller's products, and on certain private-label products manufactured by third-parties for resale by Seller, will be of shorter duration or otherwise more limited than the standard Seller limited warranty. In such cases, Seller's warranty with respect to such third-party proprietary sub-assembly modules, third-party software and private-label products will be limited to the duration and other terms of such third-party vendor's warranty, if any. In addition, certain products, that are not manufactured by Seller, but are resold by Seller, may carry the original OEM warranty for such products, if any. The limited warranty set forth above does not apply to any product sold by Seller, which at the time of sale constituted a Refurbished/Closeout Product, the limited warranty for which is provided in the following paragraph.

Seller will at its sole option, either repair or replace (with a new or factory-reconditioned product, as Seller may determine) any product sold by Seller which at the time of sale constituted a refurbished or closeout item ("**Refurbished/Closeout Product**"), which is defective in materials or workmanship or fails to meet the applicable specifications that are in effect on the date of shipment of that product or fails to meet such other specifications as may have been expressly agreed upon in writing between the parties, for a period of ninety (90) days from the date of original purchase. Notwithstanding the foregoing, in some cases the warranty on certain proprietary sub-assembly modules manufactured by third-party vendors and contained in Seller products, third party software installed in certain of Seller's products, and on certain private-label products manufactured by third-parties for resale by Seller will be of shorter duration or otherwise more limited than Seller limited warranty for Refurbished/Closeout Products. In such cases, Seller's warranty for Refurbished/Closeout Products constituting such third party proprietary sub-assembly modules, third party software, and private-label products will be limited to the duration and other terms of such third-party vendor's warranty, if any. In addition, notwithstanding the foregoing, (i) certain Refurbished/Closeout Products that are not manufactured (but are resold) by Seller, may carry the original OEM warranty for such products, if any, which may be longer or shorter than Seller's limited warranty for Refurbished/Closeout Products. All sales of Refurbished/Closeout Products are final.

To obtain service under this warranty, the defective product, together with a copy of the sales receipt, serial number if applicable, or other satisfactory proof of purchase and a brief description of the defect, must be shipped freight prepaid to Seller at the following address: One Jake Brown Road, Old Bridge, New Jersey 08857.

This warranty does not cover failure of performance or damage resulting from (i) use or installation other than in strict accordance with manufacturer's written instructions, (ii) disassembly or repair by someone other than the manufacturer or a manufacturer-authorized repair center, (iii) misuse, misapplication or abuse, (iv) alteration, (v) exposure to unusual physical or electrical stress, abuse or accident or forces or exposure beyond normal use within specified operational or environmental parameters set forth in applicable product specifications, (vi) lack of reasonable care or (vii) wind, ice, snow, rain, lightning, or any other weather conditions or acts of God.

OTHER THAN THE WARRANTIES SET FORTH ABOVE, SELLER MAKES NO OTHER WARRANTIES OR REPRESENTATIONS OF ANY KIND, EXPRESS OR IMPLIED, AS TO THE CONDITION, DESCRIPTION, FITNESS FOR A PARTICULAR PURPOSE, MERCHANTABILITY, OR AS TO ANY OTHER MATTER, AND SUCH WARRANTIES SET FORTH ABOVE SUPERSEDE ANY ORAL OR WRITTEN WARRANTIES OR REPRESENTATIONS MADE OR IMPLIED BY SELLER OR BY ANY OF SELLER'S EMPLOYEES OR REPRESENTATIVES, OR IN ANY OF SELLER'S BROCHURES MANUALS, CATALOGS, LITERATURE OR OTHER MATERIALS. IN ALL CASES, BUYER'S SOLE AND EXCLUSIVE REMEDY AND SELLER'S SOLE OBLIGATION FOR ANY BREACH OF THE WARRANTIES CONTAINED HEREIN SHALL BE LIMITED TO THE REPAIR OR REPLACEMENT OF THE DEFECTIVE PRODUCT F.O.B. SHIPPING POINT, AS SELLER IN ITS SOLE DISCRETION SHALL DETERMINE. SELLER SHALL IN NO EVENT AND UNDER NO CIRCUMSTANCES BE LIABLE OR RESPONSIBLE FOR ANY CONSEQUENTIAL, INDIRECT, INCIDENTAL, PUNITIVE, DIRECT OR SPECIAL DAMAGES BASED UPON BREACH OF WARRANTY, BREACH OF CONTRACT, NEGLIGENCE, STRICT TORT LIABILITY OR OTHERWISE OR ANY OTHER LEGAL THEORY, ARISING DIRECTLY OR INDIRECTLY FROM THE SALE, USE, INSTALLATION OR FAILURE OF ANY PRODUCT ACQUIRED BY BUYER FROM SELLER.

All claims for shortages, defects, and non-conforming goods must be made by the customer in writing within five (5) days of receipt of merchandise, which writing shall state with particularity all material facts concerning the claim then known to the customer. Upon any such claim, the customer shall hold the goods complained of intact and duly protected, for a period of up to sixty (60) days. Upon the request of Seller, the customer shall ship such allegedly non-conforming or defective goods, freight prepaid to Seller for examination by Seller's inspection department and verification of the defect. Seller, at its option, will either repair, replace or issue a credit for products determined to be defective. Seller's liability and responsibility for defective products is specifically limited to the defective item or to credit towards the original billing. All such replacements by Seller shall be made free of charge f.o.b. the delivery point called for in the original order. Products for which replacement has been made under the provisions of this clause shall become the property of Seller. Under no circumstances are products to be returned to Seller without Seller's prior written authorization. Seller reserves the right to scrap any unauthorized returns on a no-credit basis. Any actions for breach of a contract of sale between Seller and a customer must be commenced by the customer within thirteen (13) months after the cause of action has accrued. A copy of Seller's standard terms and conditions of sale, including the limited warranty, is available from Seller upon request. Copies of the limited warranties covering third-party proprietary sub-assembly modules and private-label products manufactured by third-parties may also be available from Seller on request. (Rev 0713)



One Jake Brown Road
Old Bridge, NJ 08857-1000 USA
732-679-4000 • Fax 732-679-4353
www.blondertongue.com

Printed in China

Free Manuals Download Website

<http://myh66.com>

<http://usermanuals.us>

<http://www.somanuals.com>

<http://www.4manuals.cc>

<http://www.manual-lib.com>

<http://www.404manual.com>

<http://www.luxmanual.com>

<http://aubethermostatmanual.com>

Golf course search by state

<http://golfingnear.com>

Email search by domain

<http://emailbydomain.com>

Auto manuals search

<http://auto.somanuals.com>

TV manuals search

<http://tv.somanuals.com>