

Thank you for choosing Brother. Your support is important to us and we value your business. Your Brother product is engineered and manufactured to the highest standards to deliver reliable performance, day in and day out.





Please read the Product Safety Guide before you set up your machine.

NOTE

Unless otherwise specified, illustrations in this guide show the ADS-2500We.

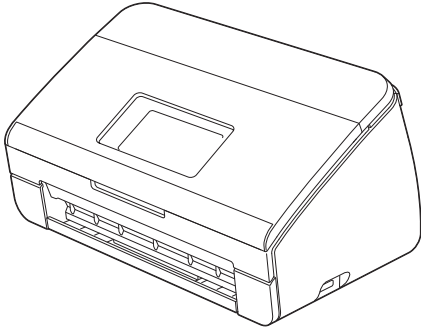
1**Unpack the machine and check the components**

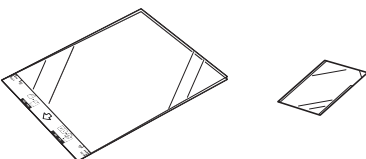
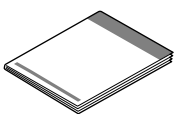
■ The components included in the box may differ depending on your country.

	 AC Power Cord	 USB Interface Cable
	 Carrier Sheet/ Plastic Card Carrier Sheet	 Quick Setup Guide Product Safety Guide
 DVD-ROM	 Product Registration Sheet (USA only) Warranty Card (USA only)	

You can download the *User's Guide* and *Network User's Guide* for your model from the Brother Solutions Center at <http://support.brother.com>. If your computer does not have a DVD-ROM drive, the supplied DVD-ROM does not contain drivers for your operating system, or you want to download manuals and utilities, visit your model page at <http://support.brother.com>

WARNING

- This product was packaged in a plastic bag. To avoid suffocation, keep plastic bags away from babies and children. Do not use the bag in cribs, beds, carriages, or play pens. The bag is not a toy.
- Use only the AC power cord supplied with this product.

NOTE

- We recommend saving the original packaging in case you must ship your machine.
- Use the supplied USB cable if you want to connect the machine to a computer.

- Remove the protective tape and film covering the machine and the LCD or Control Panel.
- Make sure you have all the components.

2 Connect the power cord

IMPORTANT

DO NOT CONNECT THE USB CABLE YET.

- a** Connect the power cord.

⚠ WARNING

The machine must be fitted with a three prong grounded plug.

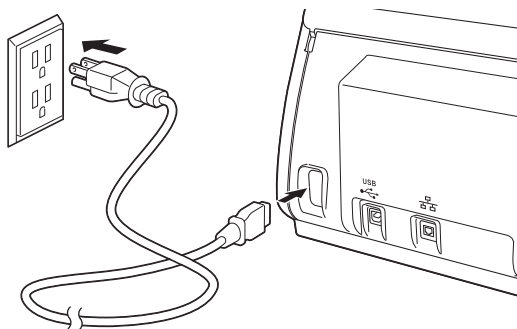

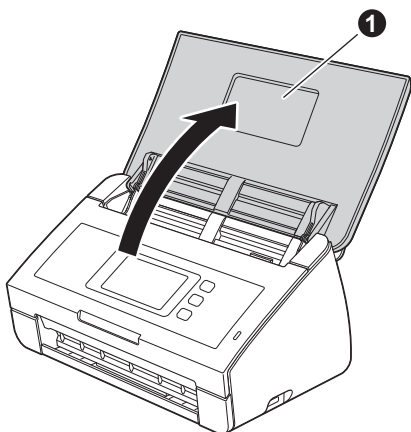

- b** Open the Top Cover ①.

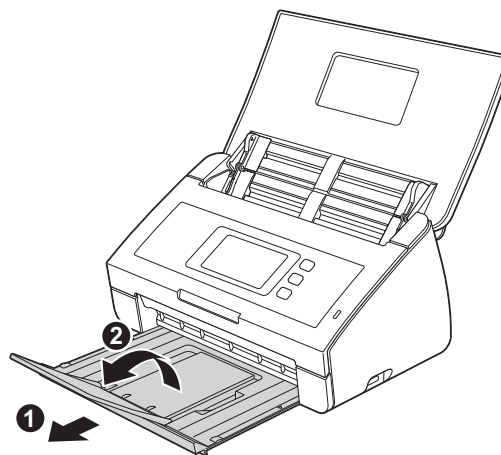

- c** Pull the Output Tray out of the machine ①, and then unfold the Document Stopper ②.



3 Choose your language (if needed) (ADS-2500We only)

- a** Press .
- b** Press ▲ or ▼ to display Initial Setup. Press Initial Setup.
- c** Press Local Language.
- d** Press ▲ or ▼ to display your language. Press your language.
- e** Press .

4

Choose your connection type

These installation instructions are for Windows® XP Home, XP Professional, Windows Vista®, Windows® 7, Windows® 8, and OS X v10.7.5, 10.8.x and 10.9.x.

If your computer does not have a DVD-ROM drive or the supplied DVD-ROM does not contain drivers for your operating system, or you want to download manuals and utilities, visit your model page at <http://support.brother.com>. Some software applications included on the DVD-ROM may not be available as a download.

NOTE

Windows® 8 users: If the Brother manuals are in PDF format, use Adobe® Reader® to open them. If Adobe® Reader® is installed on your computer but you cannot open the files in Adobe® Reader®, change the file association for PDF.

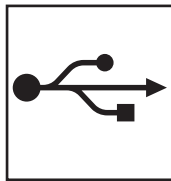
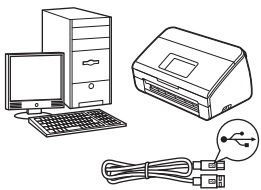

For USB interface cable

Windows®, go to page 4
Macintosh, go to page 6

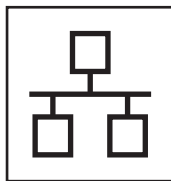
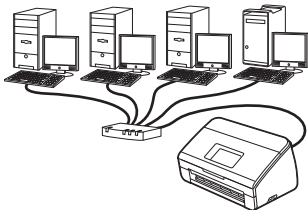

For Wired Network (ADS-2500We only)

Go to page 8

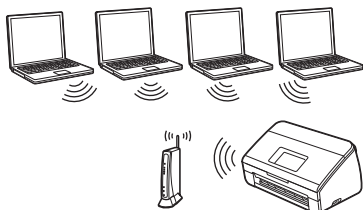

For Wireless Network (ADS-2500We only)

Go to page 12

Windows®
USB
Macintosh

Wired Network

Wireless Network



For Windows® USB interface users

(Windows® XP Home/XP Professional/Windows Vista®/Windows® 7/Windows® 8)

5 Before you install

Make sure that your computer and your Brother machine are ON.

NOTE

- **DO NOT CONNECT THE USB CABLE YET.**
- If there are any programs running, close them.
- The screens may differ depending on your operating system.
- The DVD-ROM includes Nuance™ PaperPort™ 12SE. This software supports Windows® XP Home (SP3 or greater), XP Professional (SP3 or greater), Windows Vista® (SP2 or greater), Windows® 7 and Windows® 8. Update to the latest Windows® Service Pack before installing MFL-Pro Suite.

6 Install MFL-Pro Suite

a Put the DVD-ROM into your DVD-ROM drive. If the model name screen appears, choose your machine. If the language screen appears, choose your language.

NOTE

- If the Brother screen does not appear automatically, go to **Computer (My Computer)**.
(For Windows® 8: click the  **(File Explorer)** icon on the taskbar, and then go to **Computer**.)
- Double-click the DVD-ROM icon, and then double-click **start.exe**.

b Click **Install MFL-Pro Suite**, and then click **Yes** if you accept the license agreements.

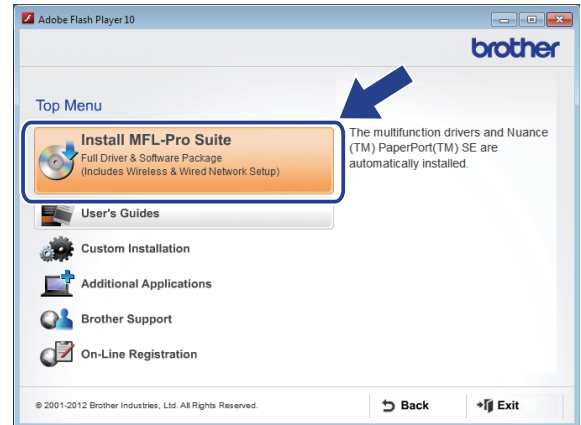

NOTE

For Windows Vista®, Windows® 7 and Windows® 8, when the User Account Control screen appears, click **Allow** or **Yes**.

c Choose **Local Connection (USB)**, and then click **Next**.

d Follow the on-screen instructions.

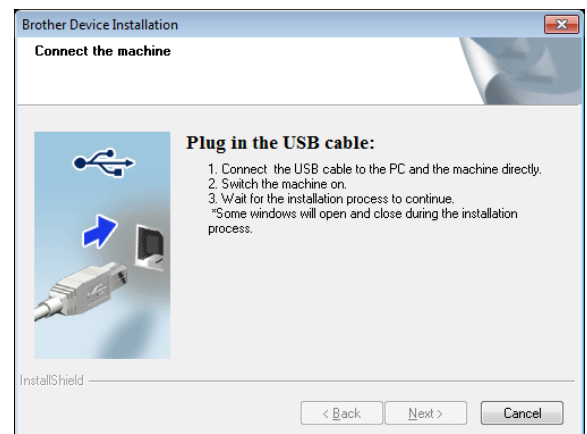



7 Connect the USB cable

- a Connect the USB cable to the USB port marked with a  symbol on the back of your machine. Connect the other end of the cable to your computer.

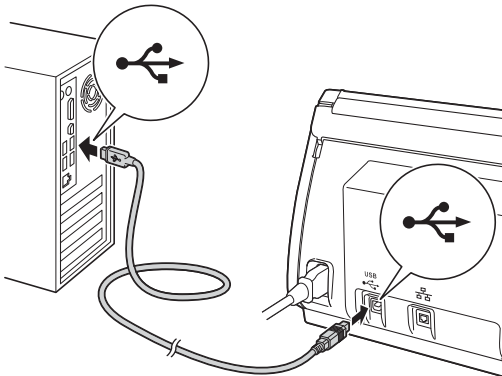

- b The installation will continue automatically. The installation screens appear one after another.

NOTE

DO NOT cancel any of the screens during the installation. It may take a few seconds for all screens to appear.

- c When the **On-Line Registration** screen is displayed, make your selection and follow the on-screen instructions.

8 Finish and restart

- a Click **Finish** to restart your computer.

NOTE

- If an error message appears during the software installation, run the **Installation Diagnostics**, double-click  (**Brother Utilities**) on the desktop, and then click the drop-down list and select your model name (if not already selected). Click **Tools** in the left navigation bar.
- Depending on your security settings, a Windows® Security or antivirus software window may appear when using the machine or its software. Please click **Allow** or **Permit** the window to continue.

- b The following screens will appear:
 - When the **Software Update Setting** screen appears, choose the software update setting you want and click **OK**.
 - When the Brother Product Research and Support Program screen appears, select your preference and follow the on-screen instructions.

NOTE

Internet access is required for the software update and the Brother Product Research and Support Program.

Finish

The installation is now complete and it is time to do a test scan. See *Test Scan (Scan to PC)* on page 21.

To install optional applications:

Now go to

Page 19



For Macintosh USB interface users

(OS X v10.7.5, 10.8.x and 10.9.x)

5 Before you install

Make sure that your Macintosh and your Brother machine are ON.

NOTE

OS X v10.6.x users must upgrade to OS X v10.7.5 - 10.9.x.

6 Connect the USB cable

NOTE

- DO NOT connect the machine to a USB port on a keyboard or a non-powered USB hub.
- Connect the machine directly to your Macintosh.

Connect the USB cable to the USB port marked with a  symbol on the back of your machine. Connect the other end of the cable to your computer.

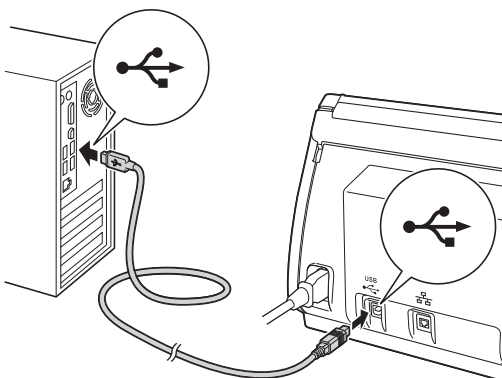

7 Install MFL-Pro Suite

- a** Download the full driver and software package from the Brother Solutions Center (<http://support.brother.com/>).
- > Select your country.
 - > Select your language.
 - > Click **Downloads**, navigate to your product page, then select your OS.

NOTE

For help identifying your OS, click the link **How to identify your Operating System (OS)**.

- b** Double-click the **Start Here OSX** icon to install. If the model name screen appears, choose your machine.



- c** Choose **Local Connection (USB)**, and then click **Next**. Follow the on-screen instructions.
- d** After the installation, the Brother software will search for the Brother device. This will take a few moments to complete.



- e Choose your machine from the list, and then click **Next**.

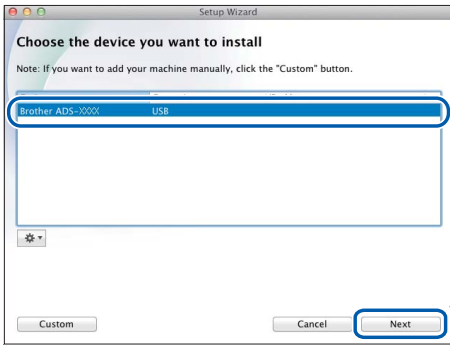

Finish

The installation is now complete and it is time to do a test scan. See *Test Scan (Scan to PC)* on page 21.

To install optional applications:

Now go to

Page 20

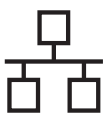

5

Connect the network cable

- a** Make sure that your computer and your Brother machine are ON.

NOTE

If there are any programs running, close them.

- b** You will find the Ethernet port marked with a  symbol on the back of the machine as shown below. Remove the protective cap and connect the network cable to the Ethernet port.

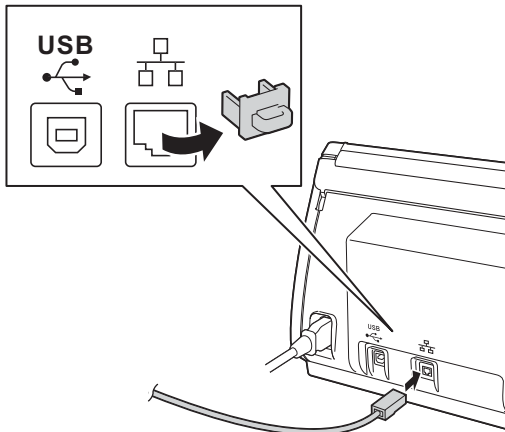

- c** Connect the cable to your network.

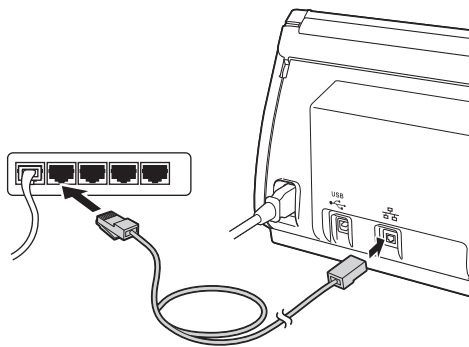

For Mobile device users:

NOTE

- Download and install Brother iPrint&Scan (Android™/iOS/Windows® Phone) from your mobile device's application download site.
- To download the User's Guide for the application you are using (Brother iPrint&Scan), visit the Brother Solutions Center at <http://support.brother.com> and click Manuals on your model's page.

Finish

The installation is now complete and it is time to do a test scan.

For Windows® users:

NOTE

- For Windows® XP Home/XP Professional/Windows Vista®/Windows® 7/Windows® 8
- The screens may differ depending on your operating system.
- The DVD-ROM includes Nuance™ PaperPort™ 12SE. This software supports Windows® XP Home (SP3 or greater), XP Professional (SP3 or greater), Windows Vista® (SP2 or greater), Windows® 7 and Windows® 8. Update to the latest Windows® Service Pack before installing MFL-Pro Suite.

Now go to

Page 9

For Macintosh users:

NOTE

- OS X v10.6.x users, upgrade to OS X v10.7.5 - 10.9.x.

Now go to

Page 11

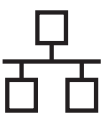

6 Install MFL-Pro Suite

a Put the supplied DVD-ROM into your DVD-ROM drive. If the model name screen appears, choose your machine. If the language screen appears, choose your language.

NOTE

- If the Brother screen does not appear automatically, go to **Computer (My Computer)**. (For Windows® 8: click the  (File Explorer) icon on the taskbar, and then go to **Computer**.)
- Double-click the DVD-ROM icon, and then double-click **start.exe**.

b The DVD-ROM Top Menu will appear. Click **Install MFL-Pro Suite** and click **Yes** if you accept the license agreements. Follow the on-screen instructions.

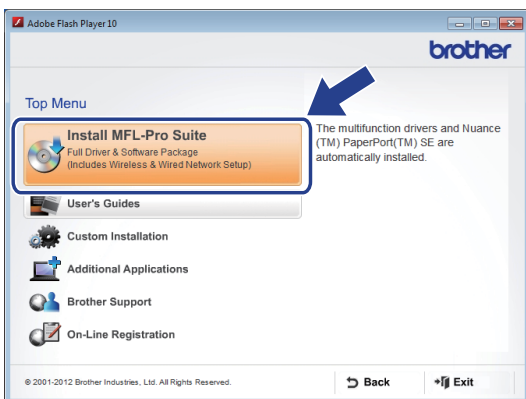

NOTE

For Windows Vista®, Windows® 7 and Windows® 8, when the User Account Control screen appears, click **Allow** or **Yes**.

c Choose **Wired Network Connection (Ethernet)**, and then click **Next**.

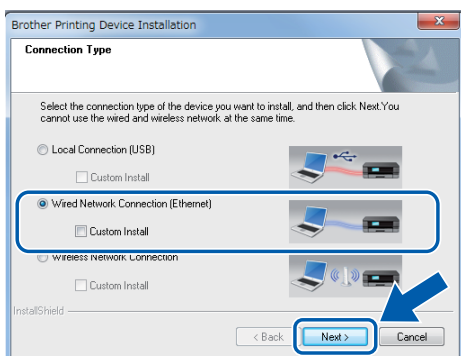

d When this screen appears, choose **Change the Firewall port settings to enable network connection and continue with the installation. (Recommended)** and click **Next**.

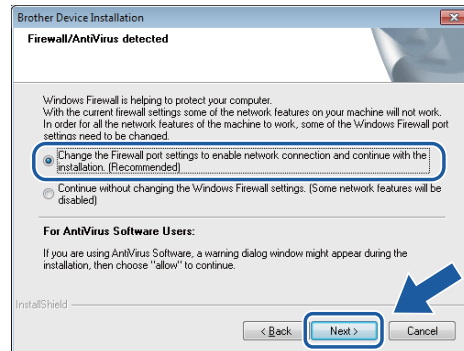

e The installation of the Brother drivers will automatically start. The installation screens appear one after another.

IMPORTANT

DO NOT cancel any of the screens during the installation. It may take a few seconds for all screens to appear.

f When the **On-Line Registration** screen appears, make your selection and follow the on-screen instructions.

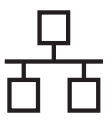

7 Finish and restart

- a** Click **Finish** to restart your computer.
- b** The following screens will appear.
 - When the **Software Update Setting** screen appears, choose the software update setting you want and click **OK**.
 - When the Brother Product Research & Support Program starts up, follow the on-screen instructions.

NOTE

Internet access is required for the software update and the Brother Product Research & Support Program.

Finish

The installation is now complete and it is time to do a test scan. See *Test Scan (Scan to PC)* on page 21.

To install optional applications:

Now go to

Page 19

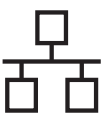

6 Install MFL-Pro Suite

- a Download the full driver and software package from the Brother Solutions Center (<http://support.brother.com/>).
 - > Select your country.
 - > Select your language.
 - > Click **Downloads**, navigate to your product page, then select your OS.

NOTE

For help identifying your OS, click the link **How to identify your Operating System (OS)**.

- b Double-click the **Start Here OSX** icon to install. If the model name screen appears, choose your machine.



- c Choose **Wired Network Connection (Ethernet)**, and then click **Next**. Follow the on-screen instructions.

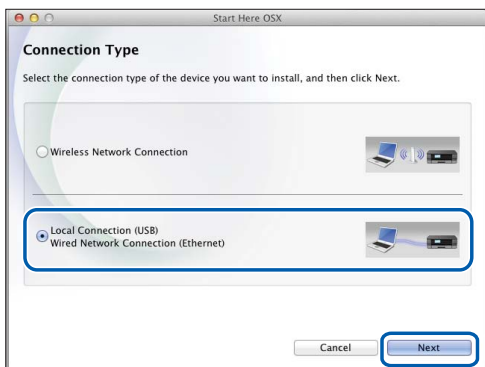

- d After the installation, the Brother software will search for the Brother device. This will take a few moments to complete.

- e Choose your machine from the list, and then click **Next**.

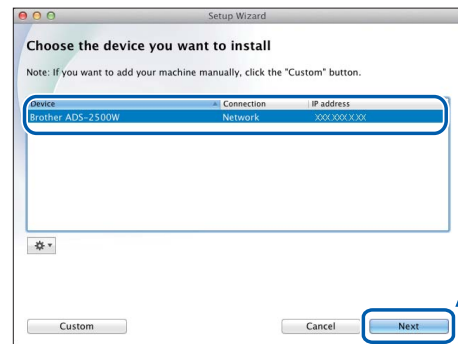

NOTE

- If your machine is not found over the network, confirm your network settings.
- You can find your machine's MAC Address (Ethernet Address) and IP Address from the control panel of the machine.
- If this screen appears, enter a name for your Macintosh up to 15 characters long, and then click **Next**.

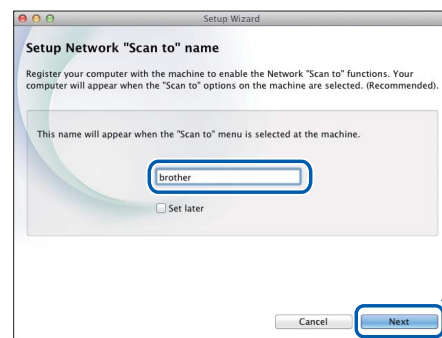

The name you enter will appear on the machine's LCD when you choose a scan option. (For more information, see Scan from the Control Panel of the Machine in the User's Guide.)

Finish

The installation is now complete and it is time to do a test scan. See **Test Scan (Scan to PC)** on page 21.

To install optional applications:

Now go to

Page 20



For wireless network interface users

5 Choose your wireless setup method

The following instructions offer two methods for setting up your Brother machine on a wireless network. If you want to scan using your mobile devices only, select method **b**. Otherwise, select method **a**.

a Setup using the driver and a USB cable (Windows® and Macintosh)

- We recommend using a computer wirelessly connected to your network for this method.
- You will need to use a USB cable temporarily during configuration.

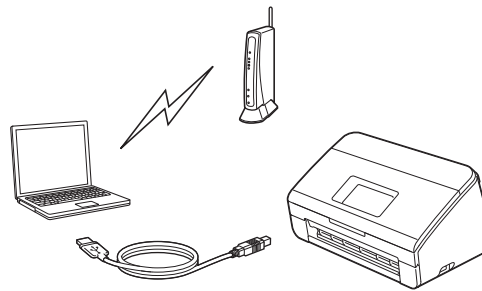

Now go to

page 13

b Setup using your Brother machine

- Use this method if you want to scan using your mobile devices only.
- If you want to scan using your computer, use method **a**.

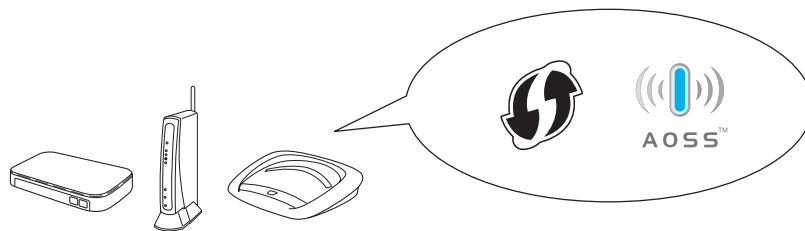

Now go to

page 16



6 Setup using the DVD-ROM and USB cable (Windows® and Macintosh)

For Macintosh Users:

For Macintosh installation, download the full driver and software package from the Brother Solutions Center (<http://support.brother.com/>). After downloading the file on your Macintosh, double-click "Start Here OSX". Select "Wireless" installation and follow the "Wireless Device Setup" instructions on your computer screen. When setup is complete, go to step g on page 15.

For Windows® Users:

- a Put the DVD-ROM into your DVD-ROM drive. If the model name screen appears, choose your machine. If the language screen appears, choose your language.

NOTE

- If the Brother screen does not appear automatically, go to **Computer (My Computer)**. (For Windows® 8: click the  (File Explorer) icon on the taskbar, and then go to **Computer**.)
- Double-click the DVD-ROM icon, and then double-click **start.exe**.

- b Click **Install MFL-Pro Suite** and click **Yes** if you accept the license agreements.

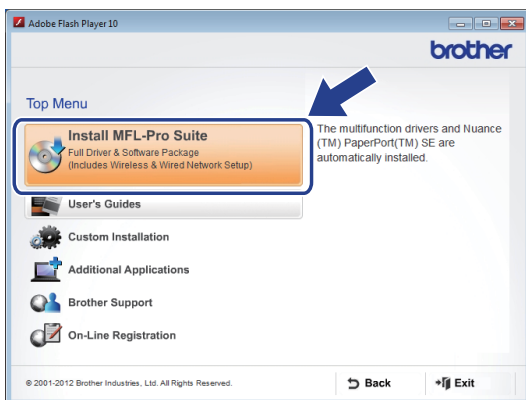

NOTE

- For Windows Vista®, Windows® 7 and Windows® 8, when the User Account Control screen appears, click **Allow** or **Yes**.
- Click **Yes** if you accept the license agreements.

- c Choose **Wireless Network Connection**, and then click **Next**.
- d When the **Firewall/AntiVirus detected** screen appears, choose **Change the Firewall port settings to enable network connection and continue with the installation. (Recommended)** and click **Next**.

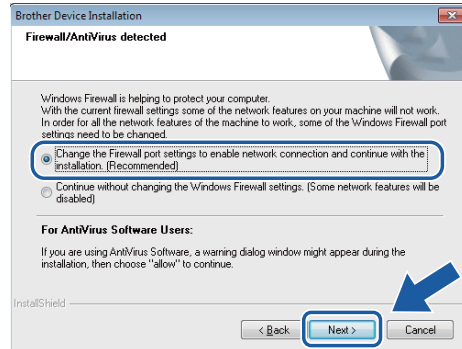

- e Follow the on-screen instructions to set up the Brother machine.
- f Your machine will now try to connect to your wireless network. It may take a few minutes.



Wireless setup is now complete.

The Wi-Fi light  on the Control Panel lights up, indicating that the machine's Network I/F is set to WLAN.

To install MFL-Pro Suite

For Windows® users:

Now go to

Step g on page 14

For Macintosh users:

Now go to

Step g on page 15



- g** Choose your machine from the list, and then click **Next**.

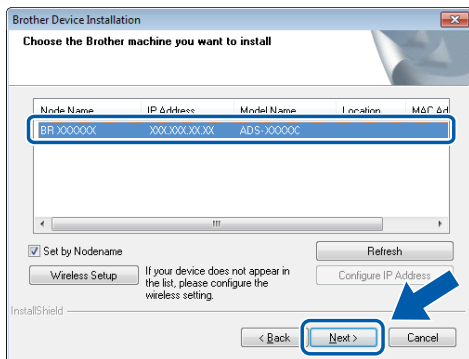

NOTE

- If your machine is not found over the network, confirm your settings by following the on-screen instructions.
- If you are using WEP and the LCD displays *Connected* but your machine is not found on the network, make sure you entered the WEP key correctly. The WEP key is case-sensitive.

- h** The installation of the Brother drivers will automatically start. The installation screens appear one after another.

NOTE

- DO NOT cancel any of the screens during the installation. It may take a few seconds for all screens to appear.
- If the **Windows Security** screen appears, select the check box and click **Install** to complete the installation correctly.

- i** When the **On-Line Registration** screen appears, make your selection and follow the on-screen instructions.

7 Finish and restart

- a** Click **Finish** to restart your computer.

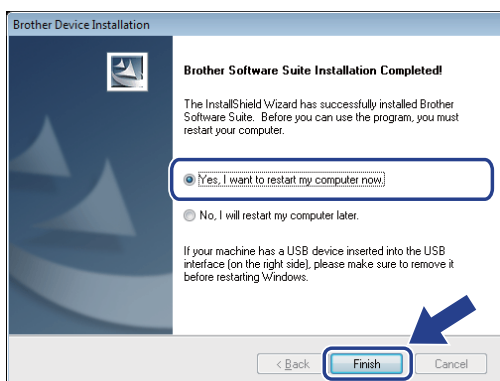



NOTE

If an error message appears during the software installation, run the **Installation Diagnostics**, double-click  (**Brother Utilities**) on the desktop, and then click the drop-down list and select your model name (if not already selected). Click **Tools** in the left navigation bar.

- b** The following screens will appear:

- When the **Software Update Setting** screen appears, choose the software update setting you want and click **OK**.
- When the Brother Product Research and Support Program starts up, follow the on-screen instructions.

NOTE

- Internet access is required for the software update and the Brother Product Research and Support Program.
- When you install MFL-Pro Suite, Brother Help will also be installed automatically. Launch Brother Help  by clicking  in the system tray. Click  to access the Brother Solutions Center.

Finish The installation is now complete and it is time to do a test scan. See **Test Scan (Scan to PC)** on page 21.

To install optional applications:

Now go to

Page 19



- 9 Choose your machine from the list, and then click **Next**.

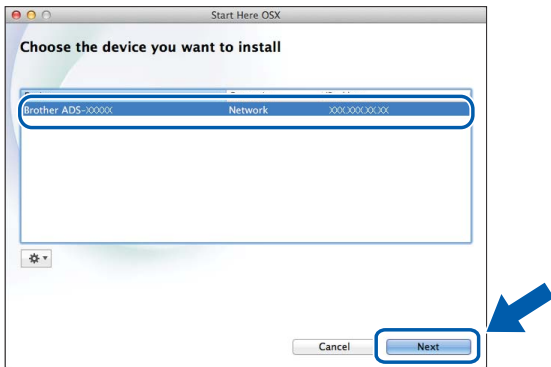

NOTE

If your wireless settings fail, the **Wireless Device Setup Wizard** screen appears. Follow the on-screen instructions to complete the wireless configuration.



- h The installation of the Brother drivers will automatically start. Please wait for the software to install.

NOTE

- You can display your machine's MAC Address (Ethernet Address) and IP Address using the machine's LCD.

To find the MAC Address, press

 (Settings) > Network > WLAN > MAC Address.

To find the IP Address, press

 (Settings) > Network > WLAN > TCP/IP > IP Address.

- If the **Setup Network "Scan to" name** screen appears, type a name for your Macintosh (up to 15 characters), and then click **Next**.

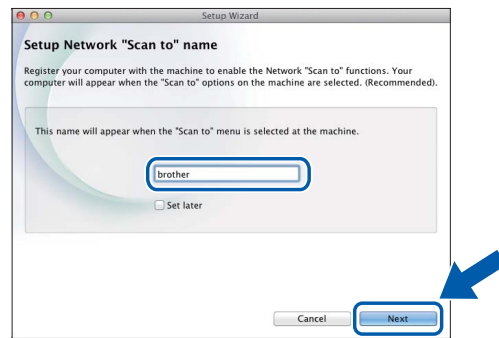

The name you type will appear on the LCD of the machine when you choose a scan option. For more information, see *Scan from the Control Panel of the Machine* in the *User's Guide*.

Finish

The installation is now complete and it is time to do a test scan. See **Test Scan (Scan to PC)** on page 21.

To install optional applications:

Now go to

Page 20



7

Setup using your Brother machine

a Place the Brother machine within range of your wireless access point/router. The range may differ depending on your environment. Refer to the instructions provided with your wireless access point/router.

b If your wireless access point/router has the WPS or AOSS™ symbol as shown below, go to **d**. If not, go to **c**.



c On the machine's LCD, press



(Settings) > Network > WLAN >

Setup Wizard. Follow the instruction on the LCD. Then go to **g**.

d On the machine's LCD, press



(Settings) > Network > WLAN >

WPS/AOSS.

When **Enable WLAN?** appears, press **Yes** to accept.

NOTE

- If you do not start WPS/AOSS from the machine's LCD a few seconds after pressing the WPS or AOSS™ button on your wireless access point/router, the connection may fail.
- If your wireless access point/router supports WPS and you want to configure your machine using the PIN (Personal Identification Number) Method, see *Configuration using the PIN Method of WPS (Wi-Fi Protected Setup)* in the *Network User's Guide*.

e When the LCD instructs you to start WPS or AOSS™, press the WPS or AOSS™ button on your wireless access point/router (for more information, see the instructions provided with your wireless access point/router).

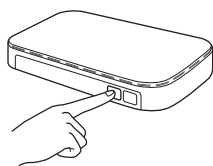

Press **OK** on your Brother machine's LCD

f

This feature will automatically detect which mode (WPS or AOSS™) your wireless access point/router uses and try to connect to your wireless network.

g

If your wireless device is connected successfully, the LCD will display the message **Connected** until you press **OK**. If the connection fails, the LCD will display an error code. Make a note of the error code, see *Troubleshooting* on page 17, and then correct the error.



Wireless setup is now complete.

The Wi-Fi light  on the Control Panel lights up, indicating that the machine's Network I/F is set to WLAN.

NOTE

- Connect your mobile device to a wireless access point/router using a Wi-Fi connection.
- Download and install Brother iPrint&Scan (Android™/iOS/Windows® Phone) from your mobile device's application download site.
- To download the User's Guide for the application you are using (Brother iPrint&Scan), visit the Brother Solutions Center at <http://support.brother.com> and click Manuals on your model's page.



Troubleshooting

If you need assistance during setup and want to contact Brother Customer Service, make sure you have your SSID (Network Name) and Network Key ready. We cannot assist you in locating this information.

How can I find the wireless security information (SSID* and Network Key**)?

- 1) Check the documentation provided with your wireless access point/router.
- 2) The default SSID could be the manufacturer's name or the model name.
- 3) If you do not know the security information, please consult the router manufacturer, your system administrator, or your Internet provider.

* If the WLAN access point/router is not broadcasting the SSID, the SSID will not automatically be detected. You must manually enter the SSID name. See *Configuring your machine when the SSID is not broadcasting* in the *Network User's Guide*.

**The Network Key may also be described as the Password, Security Key, or Encryption Key.

Error Codes

If the LCD displays an error code, locate code in the table that follows and use the recommended solution to correct the error.

Error Code	Recommended Solutions
TS-01	<p>The wireless setting is not activated.</p> <p>Turn the wireless setting to ON:</p> <ol style="list-style-type: none"> 1. On your machine, press  (Settings) > Network > WLAN > Setup Wizard. 2. When <i>Enable WLAN?</i> is displayed, press <i>Yes</i>. This will start the wireless setup wizard.
TS-02	<p>The wireless access point/router cannot be detected.</p> <ol style="list-style-type: none"> 1. Check the following: <ul style="list-style-type: none"> - Make sure that the wireless access point/router is powered on. - Move your machine to an obstruction-free area, or closer to the wireless access point/router. - Temporarily place your machine within about 3.3 feet (one meter) from the wireless access point when you are configuring the wireless settings. - If your wireless access point/router is using MAC address filtering, confirm that the Brother machine's MAC address is allowed in the filter. 2. If you manually entered the SSID and security information (SSID/authentication method/encryption method/Network Key), the information may be incorrect. <p>Confirm the SSID and security information and re-enter the correct information as necessary. See <i>How can I find the wireless security information (SSID* and Network Key**)?</i> on page 17.</p>
TS-03	<p>The wireless network and security setting you entered may be incorrect.</p> <p>Confirm the wireless network settings. See <i>How can I find the wireless security information (SSID* and Network Key**)?</i> on page 17.</p> <p>Confirm that the entered or selected SSID/authentication method/encryption method/UserID/Userpass are correct.</p>

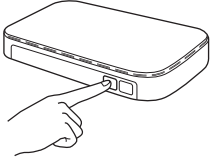

Error Code	Recommended Solutions												
TS-04	<p>The Authentication/Encryption methods used by the selected wireless access point/router are not supported by your machine.</p> <p>For infrastructure mode, change the authentication and encryption methods of the wireless access point/router. Your machine supports the following authentication methods:</p> <table border="1" data-bbox="440 412 1198 674"> <thead> <tr> <th>Authentication Method</th> <th>Encryption Method</th> </tr> </thead> <tbody> <tr> <td rowspan="2">WPA-Personal</td> <td>TKIP</td> </tr> <tr> <td>AES</td> </tr> <tr> <td>WPA2-Personal</td> <td>AES</td> </tr> <tr> <td rowspan="2">Open</td> <td>WEP</td> </tr> <tr> <td>None (without encryption)</td> </tr> <tr> <td>Shared key</td> <td>WEP</td> </tr> </tbody> </table> <p>If your problem is not solved, the SSID or network settings you entered may be incorrect. Confirm the wireless network settings. See <i>How can I find the wireless security information (SSID* and Network Key**)?</i> on page 17.</p> <p>For ad-hoc mode, change the authentication and encryption methods of your computer for the wireless setting. Your machine supports Open authentication method only, with optional WEP encryption.</p>	Authentication Method	Encryption Method	WPA-Personal	TKIP	AES	WPA2-Personal	AES	Open	WEP	None (without encryption)	Shared key	WEP
Authentication Method	Encryption Method												
WPA-Personal	TKIP												
	AES												
WPA2-Personal	AES												
Open	WEP												
	None (without encryption)												
Shared key	WEP												
TS-05	<p>The security information (SSID/Network Key) is incorrect.</p> <p>Confirm the SSID and security information (Network Key). See <i>How can I find the wireless security information (SSID* and Network Key**)?</i> on page 17.</p> <p>If your router uses WEP encryption, enter the key used as the first WEP key. Your Brother machine supports the use of the first WEP key only.</p>												
TS-06	<p>The wireless security information (Authentication method/Encryption method/Network Key) is incorrect.</p> <p>Confirm the wireless security information (Authentication method/Encryption method/Network Key) using the Authentication Method table in error TS-04. See <i>How can I find the wireless security information (SSID* and Network Key**)?</i> on page 17.</p> <p>If your router uses WEP encryption, enter the key used as the first WEP key. Your Brother machine supports the use of the first WEP key only.</p>												
TS-07	<p>The machine cannot detect a wireless access point/router that has WPS or AOSS™ enabled.</p> <p>To configure your wireless settings using WPS or AOSS™, you must operate both your machine and the wireless access point/router. Confirm that your wireless access point/router supports WPS or AOSS™, and try starting from step 7 on page 16 again.</p> <p>If you do not know how to operate your wireless access point/router using WPS or AOSS™, see the documentation provided with your wireless access point/router, ask the manufacturer of your wireless access point/router, or ask your network administrator.</p> 												
TS-08	<p>Two or more wireless access points that have WPS or AOSS™ enabled are detected.</p> <p>Confirm that only one wireless access point/router within range has the WPS or AOSS™ method active and try again.</p> <p>To avoid interference from other access points, after a few minutes, try again starting from step 7 on page 16.</p>												
TS-20	<p>The machine is still trying to connect to your wireless network. Please wait a few minutes, and then check the WLAN status.</p>												

Install Optional Applications

1 Install optional applications (Windows® users)

NewSoft Presto! BizCard 6

Presto! BizCard lets you manage the information from scanned business cards, such as names, companies, mailing addresses, phone/fax numbers and e-mail addresses on your computer. Simply scan or import your business cards, and Presto! BizCard automatically saves the data and image for each card. Different viewing modes are available for easy searching, editing, creating, and sorting.

Nuance PDF Converter Professional 8

Nuance PDF Converter Professional 8 offers a variety of features for handling PDF files. It can unlock and open PDF files for viewing, editing, annotation and re-assembly.

Enter the Nuance serial number that is shown on the MFL-Pro Suite DVD-ROM sleeve when installing Nuance PDF Converter Professional 8.

a Reinsert the DVD-ROM or double-click the **start.exe** program. If the model name screen appears, choose your machine. If the language screen appears, choose your language.

b The DVD-ROM **Top Menu** will appear. Click **Additional Applications**.

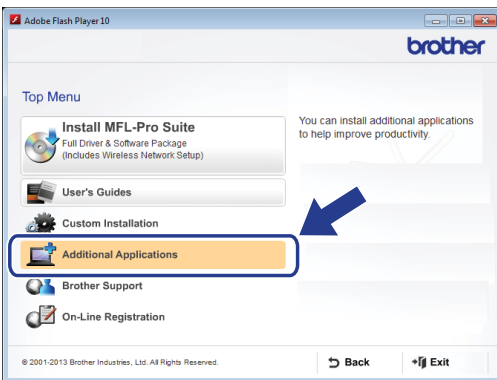



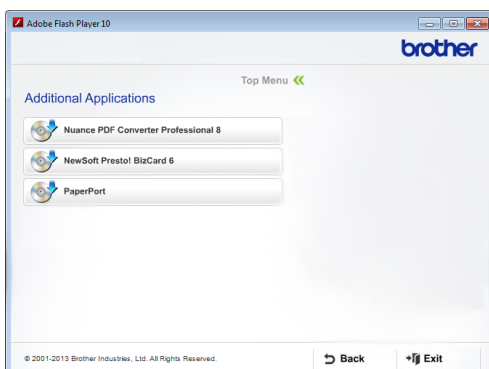

c Click the button for the application you want to install. (These applications available may differ depending on your country.)



d When installation is complete, click **Back** to go back to the **Additional Applications** screen and install other applications.

To exit, click **Exit**.

NOTE

- To start NewSoft Presto! BizCard 6, do one of the following:
 - Windows® XP, Windows Vista® and Windows® 7 users: Click  (**Start**) > **All Programs** > **NewSoft** > **Presto! BizCard 6**.
 - Windows® 8 users: Move your mouse to the lower right corner of your desktop. When the menu bar appears, click  (**Start**) and then click  (**Presto! BizCard 6**).
- To start Nuance PDF Converter Professional 8, do one of the following:
 - Windows® XP, Windows Vista® and Windows® 7 users: Click  (**Start**) > **All Programs** > **Nuance PDF Converter Professional 8** > **PDF Converter Professional**.
 - Windows® 8 users: Move your mouse to the lower right corner of your desktop. When the menu bar appears, click **Start** and then click  (**PDF Converter Professional**).

Finish

The installation is now complete.

Install Optional Applications

1 Install optional applications (Macintosh users)

NewSoft Presto! BizCard 6

Presto! BizCard lets you manage the information from scanned business cards, such as names, companies, mailing addresses, phone/fax numbers and e-mail addresses on your computer. Simply scan or import your business cards, and Presto! BizCard automatically saves the data and image for each card. Different viewing modes are available for easy searching, editing, creating, and sorting.

Presto! PageManager

Presto! PageManager adds Optical Character Recognition (OCR) capability to Brother ControlCenter2. For more detail about ControlCenter2, See *Scan Using ControlCenter2 (Macintosh)* in the User's Guide. OCR allows you to scan a document and convert its contents to text, so that you can edit the text using the word processing application of your choice. You can also scan, share and organize photos and documents using Presto! PageManager.

- a** Double-click the **Brother Support** icon to install. The **Brother Support** window will appear.



- b** Click the button for the application you want to install. (These applications available may differ depending on your country.)

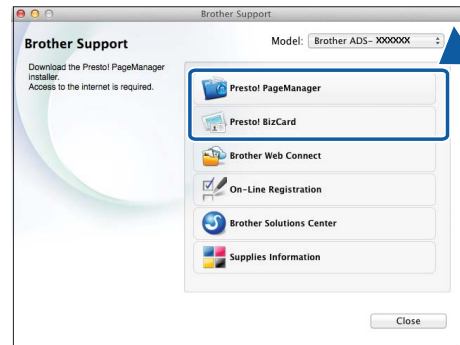

Finish The installation is now complete.

Test Scan (Scan to PC)

1

Scan your document

Your Brother scanner offers various scanning methods (see the *User's Guide*). With the following Scan to File feature, you can scan and save documents as PDF files.

To scan documents and configure various settings, please ensure you have installed the driver and connected the machine to your computer by following the instructions in this guide.

- a** Confirm that the machine is connected to your computer.
- b** Load your document.

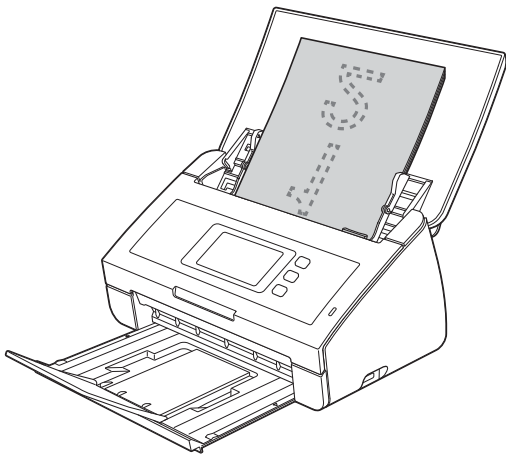

NOTE

When you load multiple documents, position the documents so that the leading edges are aligned at a slight angle in the feed direction.

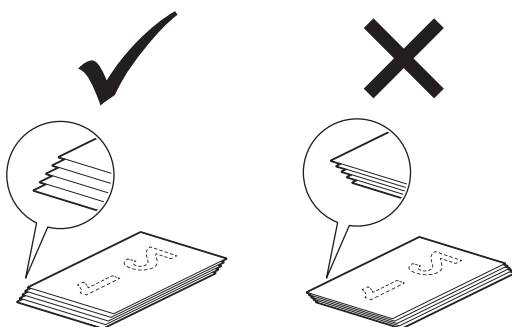

- ADS-2000e users, go to **c**.
- ADS-2500We users, go to **d**.

- c** Press  (Scan to PC key). The machine starts to feed and scan your document. Go to **i**.
- d** Swipe left or right, or press ◀ or ▶ to display Scan 1.

- e** Press to PC.
- f** Swipe left or right to select to File and then press OK.
- g** Select the destination computer you want to save to.
- h** Press Start. The machine starts to feed and scan your document.
- i** The scanned data is saved in PDF format destination folder on the computer that is connected to the machine.

Finish

The test scan is now complete.

User's Guides and where to find them

Download your Brother machine's User's Guides from the Brother Solutions Center.

<http://support.brother.com/>

and:

- > Select your country.
- > Select your language.
- > Click **Manuals**, navigate to your product page, then click on the User's Guide(s) you want.

NOTE

For help identifying your model name, click the link: [How to identify your model name.](#)

Which manual?	What's in it?
Quick Setup Guide (This book)	Follow the instructions for setting up your machine and installing the drivers and software for the operating system and connection type you are using. This Guide also includes the Safety Instructions before you set up your machine. Read the instructions first.
User's Guide	Learn the Scan operations, learn how to perform routine maintenance, and see troubleshooting tips.
Network User's Guide (ADS-2500We only)	This Guide provides useful information about network settings and security settings using the Brother machine. You can also find supported protocol information for your machine and detailed troubleshooting tips.
Web Connect Guide (ADS-2500We only)	This Guide provides useful information about accessing internet services from the Brother machine, as well as downloading images and uploading files directly from internet services.
Mobile Print/Scan Guide for Brother iPrint&Scan (ADS-2500We only)	This Guide provides useful information about scanning from your Brother machine to your mobile device when connected to a Wi-Fi network. For more information on Printing using this app to devices supporting print refer to the guide.
Brother Image Viewer Guide for Android™	This Guide provides useful information about using your Android™ mobile device to view and edit documents that were scanned by a Brother machine.
Brother ScanViewer Guide for iOS/OS X	This Guide provides useful information about using your iOS device or Macintosh computer to view and edit documents that were scanned by a Brother machine and saved to iCloud.

If you cannot download these User's Guides from the Brother Solutions Center and want to request a printed copy of any guide, call our customer service center (USA only)

1-877-BROTHER (1-877-276-8437)

brother

Visit us on the World Wide Web
<http://www.brother.com/>



www.brotherearth.com

Free Manuals Download Website

<http://myh66.com>

<http://usermanuals.us>

<http://www.somanuals.com>

<http://www.4manuals.cc>

<http://www.manual-lib.com>

<http://www.404manual.com>

<http://www.luxmanual.com>

<http://aubethermostatmanual.com>

Golf course search by state

<http://golfingnear.com>

Email search by domain

<http://emailbydomain.com>

Auto manuals search

<http://auto.somanuals.com>

TV manuals search

<http://tv.somanuals.com>