

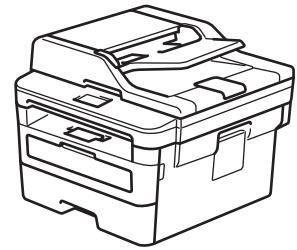

Reference Guide

Brief explanations for routine operations

DCP-B7500D
DCP-B7530DN
MFC-B7700D
MFC-B7720DN



!CAUTION Before using this product, read carefully these instructions for correct operation. Keep the User's Guide in a secure place for future reference.



Online User's Guide

For more advanced instructions, information, and product specifications, see the *Online User's Guide* at support.brother.com/manuals



To create a better environment

Please cooperate.

Firstly, thank you very much indeed for using our Brother products!

Brother focuses on the earth environment concerned. And make a basic policy which is to concern about the earth environment, including any workflow from product development to discard. The local citizen should be responsible for local society and its environment during these environment protection activities.

Therefore, we hope you'll take part in this environment plan, and pay attention to environment protection points as below while discarding used consumables.

1. Please deliver the used package materials to relevant waste disposal office for recycle.
2. When you discard used consumables, please follow and carry on relevant local regulations properly.
3. When the machine need replacing parts for the maintenance and repair, please discard used circuit boards, used electrical parts and products as disposed electrical materials.
4. The power consumption is 0 W after you turn off the machine and unplug it from the AC outlet.
5. Some parts in the machine can be used on the same series model machines which are produced in the same factory.
Note: If you want to replace the parts, please contact Brother Authorized Service Centers.
6. Machines with an LWAd > 63.0 dB(A) are recommended to be set up in separate rooms due to their noise emissions.
7. The machine can use recycled paper.
8. Ensure that during use the machine is used in a well ventilated area.
9. Brother will accept machines and consumables for recycling. For details of the return scheme please refer to the webpage www.brother.cn/company/info/declaration/20090304.html.

User's Guides and Where to Find Them

Which Guide?	What's in It?	Where Is It?
Product Safety Guide	Read this Guide first. Please read the Safety Instructions before you set up your machine. See this Guide for trademarks and legal limitations.	Printed / In the box
Quick Setup Guide	Follow the instructions for setting up your machine, and installing the Full Driver & Software Package for the operating system and connection type you are using.	Printed / In the box
Reference Guide	Learn the basic Fax, Copy and Scan operations and basic machine maintenance. See troubleshooting tips.	Printed or on Brother Installation Disc / In the Box
Online User's Guide	This guide includes the additional contents of the <i>Reference Guide</i> . In addition to information about the Print, Scan, Copy, Fax, mobile device functions, Brother ControlCenter operations and troubleshooting, other useful information is included about using the machine on a network.	Brother Solutions Center ¹
Mobile Print/Scan Guide for Brother iPrint&Scan	This Guide provides useful information about printing from your mobile device, and scanning from your Brother machine to your mobile device when connected to a Wi-Fi® network.	Brother Solutions Center ¹

¹ Visit support.brother.com/manuals.

The Online User's Guide Helps You Get the Most Out of Your Machine

We hope that you find this guide helpful. To learn more about your machine's features, please take a look at our *Online User's Guide*. It offers:

Quicker Navigation!

- ✓ Search box
- ✓ Navigation index in a separate panel

Comprehensive Format!

- ✓ Every topic in one guide

Simplified Layout!

- ✓ Step-by-step instructions
- ✓ Feature summary at the top of the page



1. Search Box
2. Navigation
3. Summary
4. Step-by-Step Instructions

To View Online User's Guides

To view the *Online User's Guide* and other available guides, visit support.brother.com/manuals.

(Windows®)

You can also access your machine's guides using Brother Utilities. The Brother Utilities tool is included in the standard installation and, when installed, you can find it either as a shortcut on your desktop, or from the Windows® **Start** menu.

Questions or Problems? Take a Look at our FAQs, Solutions, and Videos Online.

Go to your model's **FAQs & Troubleshooting** page on the Brother Solutions Center at support.brother.com

- **Provides several ways to search**
- **Displays related questions for more information**
- **Receives regular updates based on customer feedback**

©2017 Brother Industries, Ltd. All rights reserved.

Table of Contents

1	General Information	1
	Control Panel Overview	1
2	Load Paper	7
	Load Paper in the Paper Tray	7
	Load Paper in the Manual Feed Slot	7
A	Troubleshooting	8
	Identify the Problem.....	8
	Error and Maintenance Messages.....	9
	Document and Paper Jams	10
B	Appendix	11
	Supplies.....	11
	Print and Scan Using Your Mobile Device	12

Control Panel Overview

The control panel may vary depending on your model.

MFC-B7700D/MFC-B7720DN

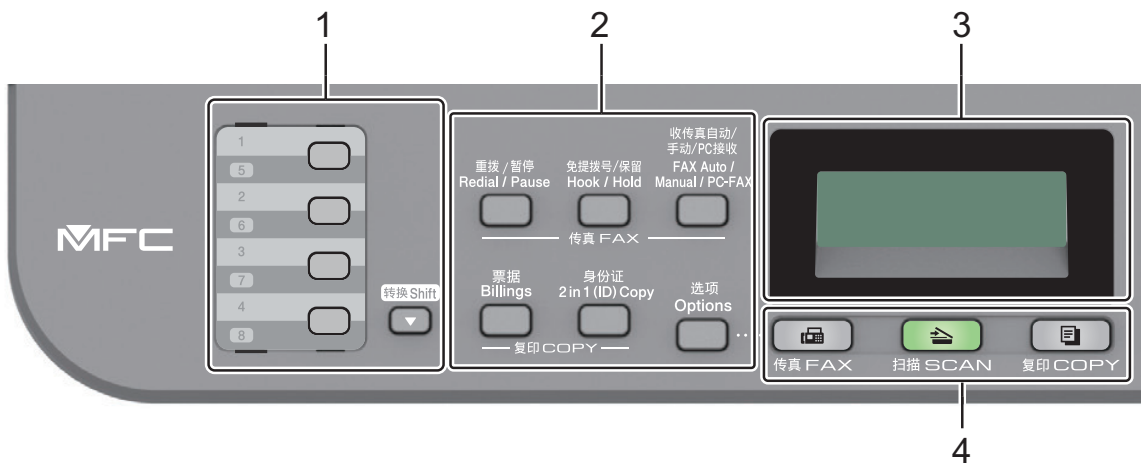

1. One Touch buttons

Store and recall up to eight fax and telephone numbers.

To access stored One Touch fax and telephone numbers 1-4, press the One Touch button assigned to that number. To access stored One Touch fax and telephone numbers 5-8, press and hold **Shift** as you press the button.

2. Function buttons

Redial/Pause

Press to dial the last number you called. This button also inserts a pause when programming quick dial numbers or when dialling a number manually.

Hook/Hold

Press **Hook/Hold** before dialing to ensure a fax machine answers, and then press **Start**.

Press **Hook/Hold** to place a call on hold.

FAX Auto/Manual/PC-FAX

Press **FAX Auto/Manual/PC-FAX** to change the Fax receive mode.

NOTE

If you select PC-FAX using this button, the back-up print function is not available to select. To use the back-up print function, select [PC Fax Receive] in the receive mode setting. The machine will transfer the received fax data to the designated computer and the fax data will not remain in your machine in the PC-Fax mode. You can print the received fax data at your machine as a backup if you turn on the back-up print function.

2 in 1 (ID) Copy

Press to copy both sides of an identification card onto a single page.

Billings

Press to copy an identification card or bills.

Options

Press to access temporary settings for faxing, scanning, or copying.

3. Liquid Crystal Display (LCD)

Displays messages to help you set up and use the machine.

If the machine is in Fax Mode, the LCD displays:

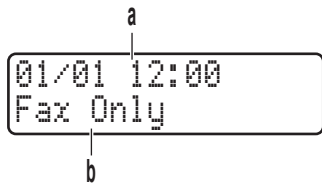

a. Date & Time

b. Receive Mode

When you press **COPY**, the LCD displays:

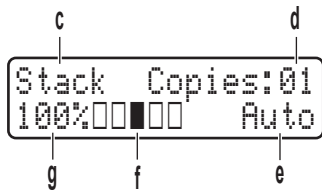

c. Type of copy

d. Number of copies

e. Quality

f. Contrast

g. Copy ratio

4. Mode buttons

FAX

Press to switch the machine to FAX Mode.

SCAN

Press to switch the machine to SCAN Mode.

COPY

Press to switch the machine to COPY Mode.

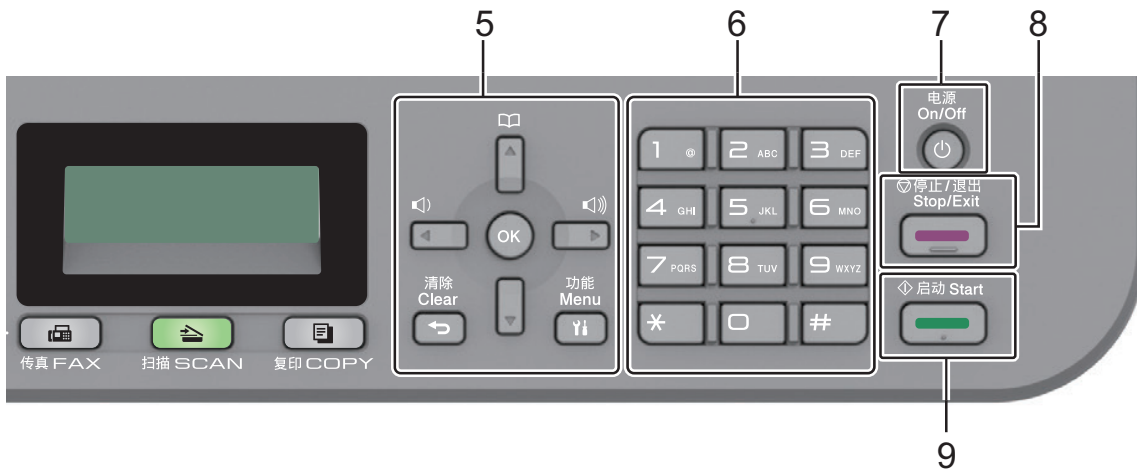

5. Menu buttons

Clear

Press to delete entered data or cancel the current setting.

Menu

Press to access the Menu for programming your machine settings.

OK

Press to store your machine settings.

◀ or ▶

Press to scroll back or forward through menu selections.

▲ or ▼

- Press to scroll up or down through menus and options.
- Press to change the resolution in Fax Mode.





Press  to access speed dial numbers.

6. Dial Pad

- Use to dial fax and telephone numbers.
- Use as a keyboard to enter text or characters.

7. On/Off

- Turn on the machine by pressing .
- Turn off the machine by pressing and holding . The LCD displays [Shutting Down] and stays on for a few seconds before turning off. If you have an external telephone or TAD connected, it is always available.

8. Stop/Exit



- Press to stop an operation.
- Press to exit from a menu.

9. Start

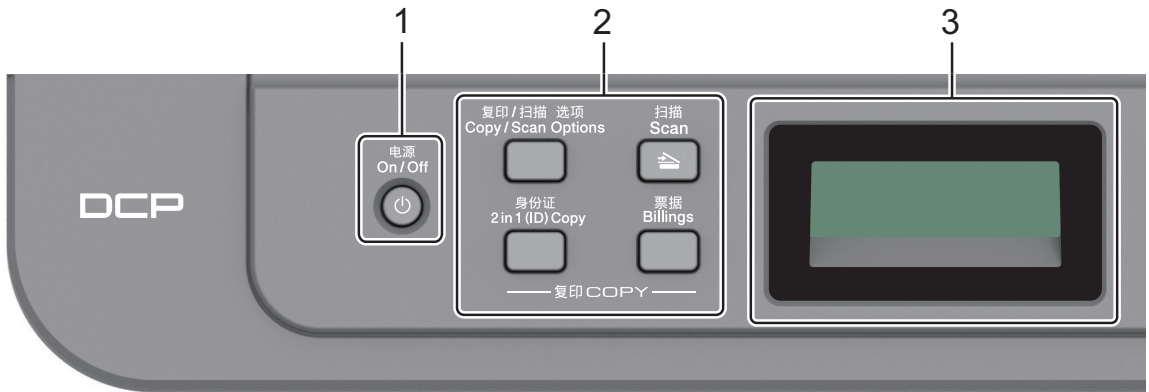
- Press to start sending faxes.
- Press to start copying.
- Press to start scanning documents.



1. On/Off

- Turn on the machine by pressing .
- Turn off the machine by pressing and holding . The LCD displays [Shutting Down] and stays on for a few seconds before turning off.

2. Function buttons

Copy/Scan Options

Press to access temporary settings for scanning or copying.

Scan

Press to switch the machine to Scan Mode.

2 in 1 (ID) Copy

Press to copy both sides of an identification card onto a single page.

Billings

Press to copy an identification card or bills.

3. Liquid Crystal Display (LCD)

Displays messages to help you set up and use the machine.

If the machine is in Ready Mode or COPY Mode, the LCD displays:

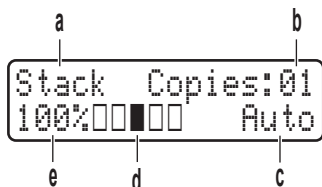

- Type of copy
- Number of copies
- Quality
- Contrast
- Copy ratio

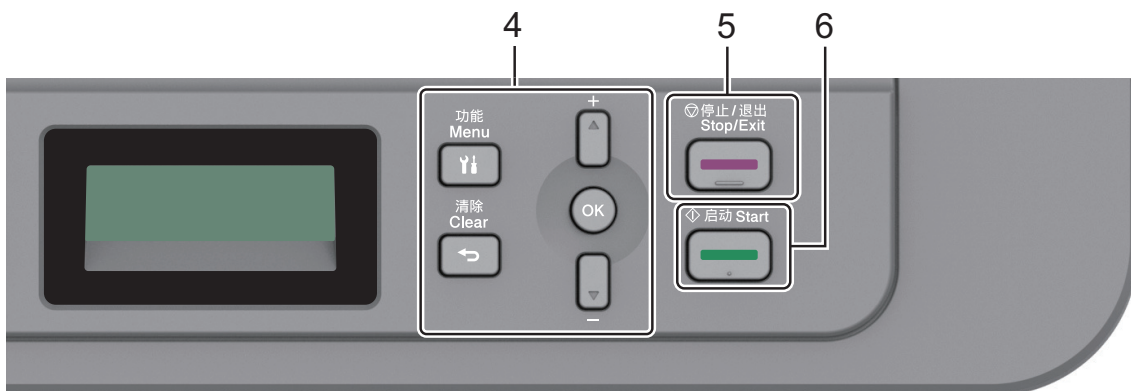

4. Menu buttons

Menu

Press to access the Menu for programming your machine settings.

Clear

- Press to delete entered data.
- Press to cancel the current setting.

OK

Press to store your machine settings.

▲ or ▼

Press to scroll up or down through menus and options.

5. Stop/Exit

- Press to stop an operation.
- Press to exit from a menu.

6. Start

- Press to start copying.
- Press to start scanning documents.

Load Paper in the Paper Tray

Use the paper tray when printing on the following media:

Plain paper

Thin paper

Recycled paper

Thick paper

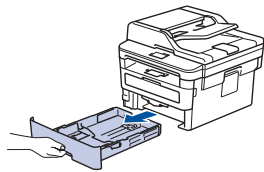

- Adjust the guides
- Fan the paper
- Do not exceed this mark

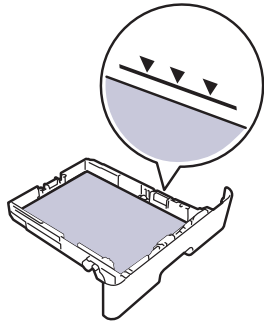

For more detailed information, see the *Online User's Guide: Load Paper in the Paper Tray*.

Load Paper in the Manual Feed Slot

Use the Manual Feed Slot when printing on the following media:

Plain paper

Thin paper

Recycled paper

Bond paper

Thick paper

Labels ¹

Envelopes ¹

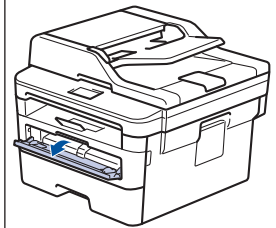

- Adjust the guides
- Use both hands to insert one sheet of paper
- Continue pressing the paper against the rollers for about two seconds, or until the machine grabs the paper and pulls it in further

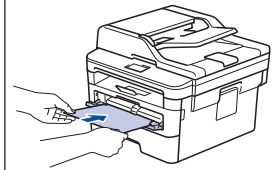

¹ Open the back cover (face up output tray) before printing to let the printed paper exit onto the face up output tray.

For more detailed information, see the *Online User's Guide: Load and Print Paper in the Manual Feed Slot*.





Use this section to resolve problems you may encounter when using your Brother machine.

Identify the Problem

Even if there seems to be a problem with your machine, you can correct most problems yourself.

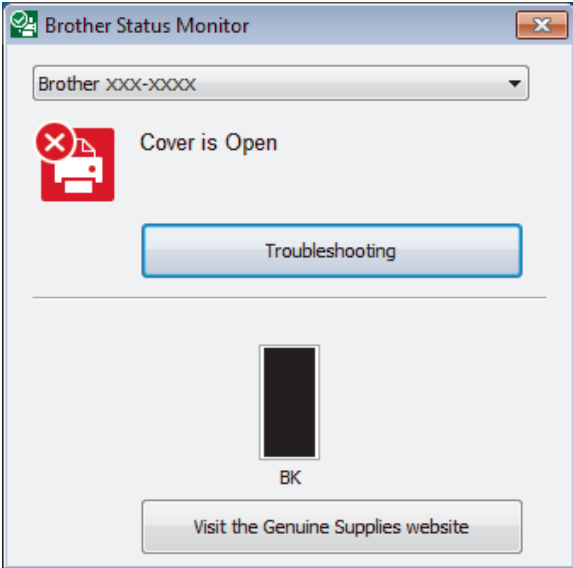
First, check the following:

- The machine's power cord is connected correctly and the machine's power is on.
- All of the machine's orange protective parts have been removed.
- (For network models) The access point (for wireless network), router, or hub is turned on and its link indicator is blinking.
- Paper is inserted correctly in the paper tray.
- The interface cables are securely connected to the machine and the computer.
- Check the machine's status on your machine or in **Brother Status Monitor** on your computer.

Find the Error	Find the Solution
<p>Using the Status Monitor</p> <ul style="list-style-type: none"> • Double-click the  icon in the task tray.  <ul style="list-style-type: none"> • (Windows®) If you select the Load Status Monitor on Startup check box, the Status Monitor will launch automatically each time you start your computer. 	<ul style="list-style-type: none"> • A green icon indicates the normal stand-by condition. <ul style="list-style-type: none">  • A yellow icon indicates a warning. <ul style="list-style-type: none">  • A red icon indicates an error has occurred. <ul style="list-style-type: none">  • A grey icon indicates the machine is offline. <ul style="list-style-type: none">  • Click the Troubleshooting button to access Brother's troubleshooting website.

Find the Error	Find the Solution
<p>Using the LCD</p> <div data-bbox="120 214 436 295" style="border: 1px solid black; padding: 5px; width: fit-content;"> <p>Cover is Open XXXXXXXXXX</p> </div>	<ol style="list-style-type: none"> 1. Follow the messages on the LCD. 2. If you cannot resolve the error, refer to the following: <i>Online User's Guide: Error and Maintenance Messages</i> FAQs & Troubleshooting page at support.brother.com

Error and Maintenance Messages

For information on the most common error and maintenance messages, see the *Online User's Guide*.

To view the *Online User's Guide* and other available guides, visit support.brother.com/manuals.

Document and Paper Jams

An error message indicates where the paper is stuck in your machine.

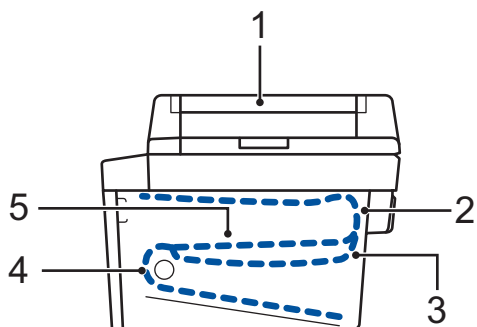

Error messages:

1. Document Jam
2. Jam Rear
3. Jam 2-sided
4. Jam Tray
5. Jam Inside

See the messages in **Brother Status Monitor** on your computer.

Supplies

When the time comes to replace supplies, such as the toner or drum, an error message will appear on your machine's control panel or in the Status Monitor. For more information about the supplies for your machine, visit www.brother.com/original/index.html or contact your local Brother dealer.



- The supply model name will vary depending on your country and region.

Toner-Cartridge

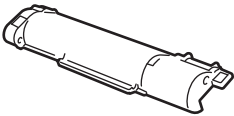

Supply Model Name	Approximate Life (Page Yield)	Applicable Models
Toner Box: TN-B020	Approximately 2,600 pages ^{1 2}	DCP-B7500D/DCP-B7530DN/ MFC-B7700D/MFC-B7720DN

¹ Approximate cartridge yield is declared in accordance with ISO/IEC 19752.

² A4/Letter simplex pages

Drum Unit

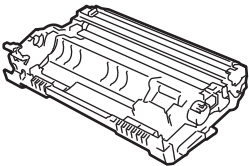

Supply Model Name	Approximate Life (Page Yield)	Applicable Models
DR-B020	Approximately 12,000 pages ¹	DCP-B7500D/DCP-B7530DN/ MFC-B7700D/MFC-B7720DN

¹ Approximately 12,000 pages based on 1 page per job [A4/Letter simplex pages]. The number of pages may be affected due to a variety of factors including but not limited to media type and media size.



If you are using Windows®, double-click the **Brother Creative Center** icon  on your desktop to access our **FREE** website designed as a resource to help you easily create and print customised materials for business and home use with photos, text and creativity.

Mac users can access Brother CreativeCenter at this web address:

www.brother.com/creativecenter

Print and Scan Using Your Mobile Device

Brother iPrint&Scan for Mobile allows you to use features of your Brother machine directly from your mobile device, without using a computer. The *Mobile Print/Scan Guide for Brother iPrint&Scan* contains information on printing from your mobile device. Go to your model's **Manuals** page on the Brother Solutions Center at support.brother.com to see the guide.

brother

Visit us on the World Wide Web
www.brother.com

These machines are approved for use in the country of purchase only. Local Brother companies or their dealers will support only machines purchased in their own countries.



CHN-ENG
Version 0

Free Manuals Download Website

<http://myh66.com>

<http://usermanuals.us>

<http://www.somanuals.com>

<http://www.4manuals.cc>

<http://www.manual-lib.com>

<http://www.404manual.com>

<http://www.luxmanual.com>

<http://aubethermostatmanual.com>

Golf course search by state

<http://golfingnear.com>

Email search by domain

<http://emailbydomain.com>

Auto manuals search

<http://auto.somanuals.com>

TV manuals search

<http://tv.somanuals.com>