

# Operation Manual

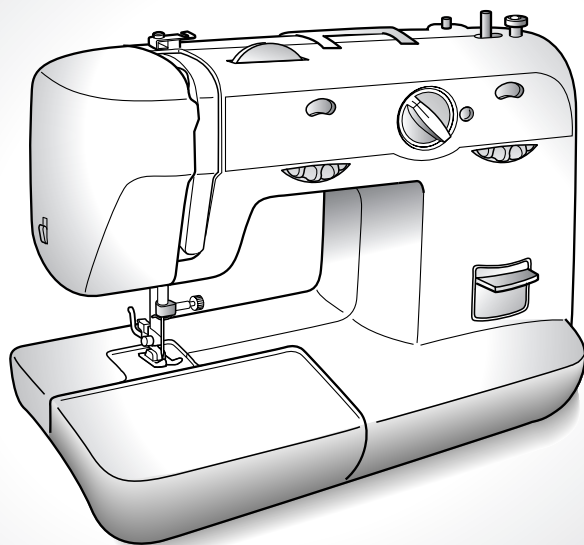

## IMPORTANT SAFETY INSTRUCTIONS

When using this machine, basic safety precautions, including the following, should always be taken:

Read all instructions before use.

### **DANGER** - To reduce the risk of electric shock:

1. The machine should never be left unattended while plugged in. Always unplug the machine from the electrical outlet immediately after using it and before cleaning it.
2. Always unplug the machine before you change the light bulb.  
Replace the bulb with the same type and rated 15 watts.

### **WARNING** - To reduce the risk of burns, fire, electric shock, or injury to persons:

1. Do not allow this machine to be used as a toy. Close attention is necessary when the machine is used by or near children.
2. Use this machine only for its intended use as described in this manual. Use only accessories recommended by the manufacturer as contained in this manual.
3. Never operate this machine if it has a damaged cord or plug, if it is not working properly, if it has been dropped or damaged, or dropped into water. Return the machine to the nearest authorized dealer or service center for examination, repair, or electrical or mechanical adjustment.
4. Never operate the machine with any air openings blocked. Keep ventilation openings of the machine and foot controller free from the accumulation of lint, dust, and loose cloth.
5. Never drop or insert any object into any opening.
6. Do not use outdoors.
7. Do not operate where aerosol (spray) products are being used or where oxygen is being administered.
8. To disconnect the machine, set the main switch to the "O" position (which represents off), and then remove the plug from the outlet.
9. Do not unplug by pulling on the cord. To unplug, grasp the plug, not the cord.
10. Keep fingers away from all moving parts. Special care is required around the machine needle.
11. Always use the proper needle plate. The wrong plate can cause the needle to break.
12. Do not use bent needles.
13. Do not pull or push fabric while stitching. It may deflect the needle, causing it to break.
14. Switch the machine to the "O" position to turn it off when making any adjustments in the needle area, such as threading the needle, changing the needle, threading the bobbin, or changing the presser foot.
15. Always unplug the machine from the electrical outlet when removing covers, lubricating, or when making any other user servicing adjustments mentioned in the instruction manual.
16. This sewing machine is not intended for use by young children or infirm persons without supervision.
17. Young children should be supervised to ensure that they do not play with this machine.

**SAVE THESE INSTRUCTIONS**  
**This machine is intended for household use.**

## FOR USERS IN THE UK, EIRE, MALTA AND CYPRUS ONLY

If this machine is fitted with a three-pin non-rewireable BS plug then please read the following.

### IMPORTANT (in the United Kingdom)

Main supply (AC 230/240V, 50Hz)

DO NOT cut off the main plug from the equipment. If the plug fitted is not suitable for the power outlet in your home or the cable is too short to reach a power outlet, then obtain an appropriate safety-approved extension lead or consult your dealer.

BE SURE to replace the fuse only with an identical approved type, as originally fitted, and to replace the fuse cover.

If the main plug is cut off, be sure to remove the fuse and dispose of the plug immediately, to avoid a possible shock hazard by inadvertent connection to the main power supply.

### IMPORTANT (in the other countries)

If the available socket outlet is not suitable for the plug supplied with this equipment, it should be cut off and an appropriate three-pin plug should be fitted. With alternative plugs, an approved fuse must be fitted in the plug.

**NOTE:** The plug severed from the main leads must be destroyed as a plug with bared flexible cords is hazardous if engaged in a live socket outlet. In the event that the plug fuse is replaced, use a fuse approved by ASTA to BS 1362, i.e., carrying the  mark, rated as marked on the plug.

Always replace the fuse cover. Never use plugs with the fuse cover omitted.

**WARNING: DO NOT CONNECT EITHER WIRE TO THE EARTH TERMINAL WHICH IS MARKED WITH THE LETTER 'E' OR BY THE EARTH SYMBOL  $\perp$ , OR COLORED GREEN OR GREEN AND YELLOW.**

The wires in this main lead are colored in accordance with the following code:

Blue	Neutral
Brown	Live

As the colors of the wiring in the main lead of this appliance may not correspond with the colored markings identifying the terminals in your plug, proceed as follows:

The wire that is colored blue must be connected to the terminal marked with the letter 'N' or colored black or blue.

The wire that is colored brown must be connected to the terminal marked with the letter 'L' or colored red or brown.

## CONNECTING PLUGS AND MAIN POWER/SEWING LIGHT SWITCH

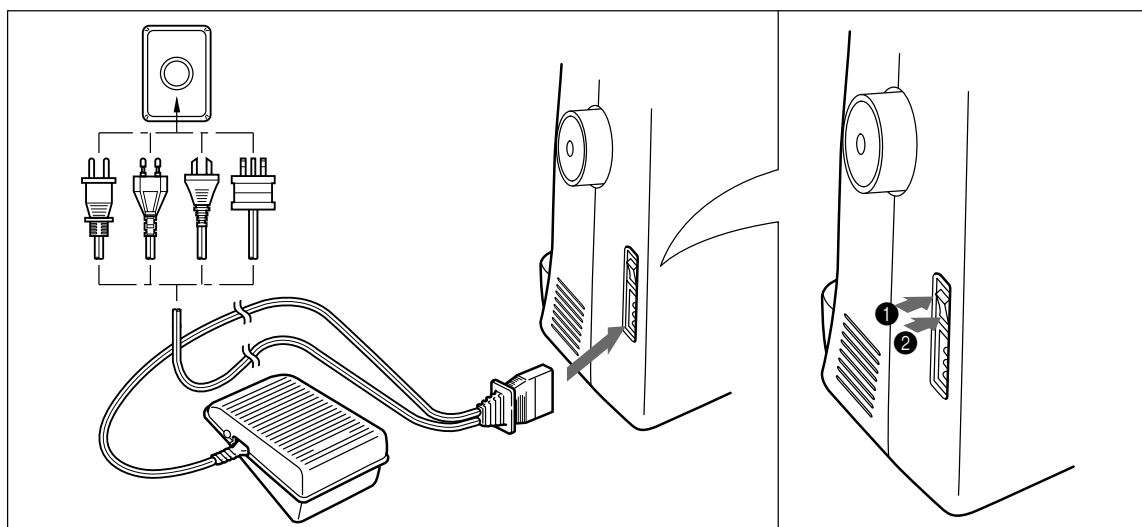

1. Connect the three-prong plug into the machine.
2. Connect the electrical supply plug into a wall outlet.

- When leaving the machine unattended, the main power switch of the machine should be switched off or the plug must be removed from the socket outlet.

The main power/switch turns the main power and sewing light on or off.

- 1 Turn on
  - 2 Turn off
- When servicing the machine, removing covers or changing bulbs, the machine must be unplugged.

# CONTENTS

<b>IMPORTANT SAFETY INSTRUCTIONS</b> .....	<b>1</b>
<b>CONNECTING PLUGS AND MAIN POWER/SEWING LIGHT SWITCH</b> .....	<b>2</b>
<b>CONTENTS</b> .....	<b>3</b>
<b>PRINCIPAL PARTS</b> .....	<b>4</b>
<b>ACCESSORIES</b> .....	<b>5</b>
<b>USING YOUR SEWING MACHINE</b> .....	<b>6</b>
Connecting Plugs .....	6
Main Power/Sewing Light Switch .....	7
Foot Controller .....	7
Inserting the Needle .....	7
Checking the Needle .....	8
Changing the Presser Foot .....	8
Converting to Free-arm Style .....	9
Steadying the Machine .....	9
<b>THE CONTROLS</b> .....	<b>10</b>
Pattern Selection Dial .....	10
Recommended Widths and Lengths for Stitches .....	11
Stitch Length Dial .....	13
Stretch Stitching .....	13
Stitch Width Dial .....	14
Reverse Sewing Lever .....	14
Drop Feed Lever (if the machine is equipped with a drop feed lever) .....	14
<b>THREADING THE MACHINE</b> .....	<b>15</b>
Winding the Bobbin .....	15
Lower Threading .....	16
Upper Threading .....	18
Using the Needle Threader (models equipped with a needle threader) .....	19
Quick Thread-Setting System FAST START BOBBIN (models equipped with a quick thread-setting system) .....	20
Drawing up the lower thread .....	21
Sewing with a Twin Needle .....	21
Tension of the Thread .....	22
<b>CHART OF SEWING FABRICS, NEEDLES AND THREAD COMBINATIONS</b> .....	<b>24</b>
Please Read Before Sewing .....	25
Straight Stitching .....	25
Zigzag Stitching .....	26
Blind Hem Stitching .....	27
Shell Tuck Stitching .....	27
Elastic Stitching .....	28
Scalloped Stitching .....	28
Double Action Stitching .....	29
Overedge Stitching .....	29
Feather Stitching .....	29
Triple Zigzag Stretch Stitching .....	30
Decorative Stitching .....	30
Making a Buttonhole (1-Step Automatic Buttonhole) .....	30
Making a Buttonhole (4-Step Buttonhole) .....	31
Adjusting Buttonholes .....	33
Sewing Buttons .....	33
Zipper Insertion .....	34
Gathering .....	35
Darning .....	35
Appliqués .....	36
Monogramming and Embroidering .....	36
<b>MAINTENANCE</b> .....	<b>38</b>
Changing the Light Bulb .....	38
Oiling .....	38
Cleaning .....	39
Performance Checklist .....	40
Repacking the Machine .....	42
<b>INDEX</b> .....	<b>43</b>

## PRINCIPAL PARTS

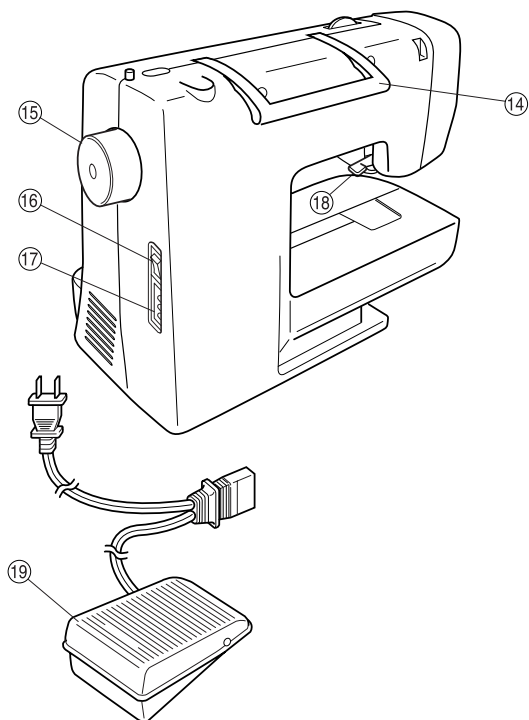
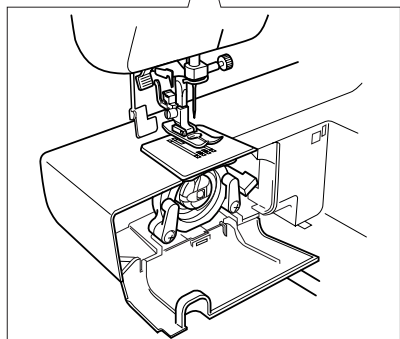
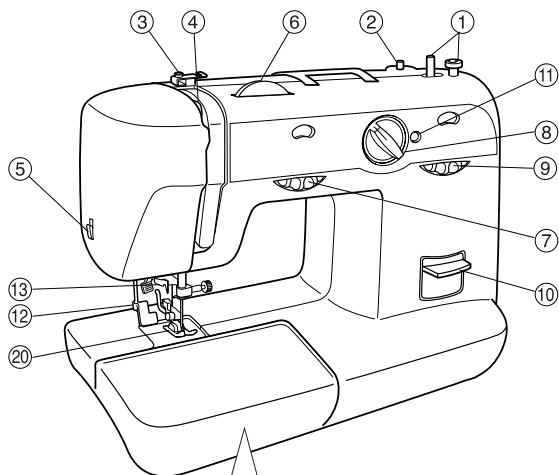

- ① **Bobbin-winding assembly (page 15)**  
This winds the thread onto the bobbin, which you use for the lower thread.
- ② **Spool pin (page 15 and 18)**  
Holds the spool of thread.
- ③ **Bobbin-winding tension disc and thread guide (page 15)**
- ④ **Thread take-up lever (page 18)**
- ⑤ **Thread cutter (page 26)**
- ⑥ **Upper tension-control dial (page 22)**  
This controls the tension of the upper thread.
- ⑦ **Stitch width dial (page 14)**  
This controls the stitch width.
- ⑧ **Pattern selection dial (page 10)**  
You can turn this in either direction to choose the stitch you want.
- ⑨ **Stitch length dial (page 13)**  
This controls the length of the stitches.
- ⑩ **Reverse-sewing lever (page 14)**  
You can push this to stitch in the reverse direction.
- ⑪ **Buttonhole fine adjustment screw (page 33)**
- ⑫ **Buttonhole lever (1-Step automatic buttonhole) (page 30)**
- ⑬ **Needle threader (page 19)**  
This is only available on certain models.

- ⑭ **Handle**
- ⑮ **Balance wheel**  
Turn toward you (counterclockwise) to raise and lower the needle.
- ⑯ **Main power/sewing light switch (page 7)**  
You can turn the main power and sewing light on and off.
- ⑰ **Foot controller receptacle (page 6)**  
Plug in the foot controller plug and connect the machine to the power supply.
- ⑱ **Presser foot lever (page 8)**  
This raises and lowers the presser foot.
- ⑲ **Foot controller (page 7)**  
You can use this to control the sewing speed, and to start and stop sewing.
- ⑳ **Zigzag presser foot**

# ACCESSORIES

①

XA4911-151

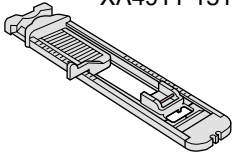

(For 1 Step Automatic Buttonhole)

X59369-321

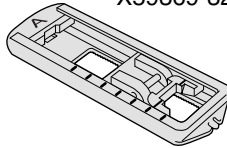

(For 4 Step Buttonhole)

② X59370-021

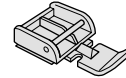

③ X59375-121

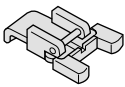

④ 129583-001



⑤ X57521-001

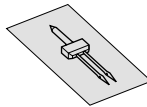

⑥ SA156(For U.S.A.)  
SFB(XA5539-151)(For other countries)

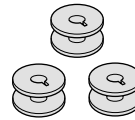

⑦ X55467-021

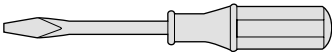

⑧ 130920-021

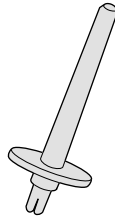

⑨ XA3442-121

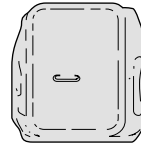

- ① Buttonhole foot (1 pc.)
- ② Zipper foot (1 pc.)
- ③ Button sewing foot (1 pc.)
- ④ Needle pack (regular single needle HAX130) (3 pcs.)
- ⑤ Twin needle (1 pc.)
- ⑥ Bobbins (3 pcs.)
- ⑦ Screwdriver (1 pc.)
- ⑧ Extra spool pin (1 pc.)
- ⑨ Darning plate (1pc.) (When the machine is not equipped with a Drop Feed.)

Parts code for zigzag presser foot: 138135-122

Foot controller:

- XC7359-021 (110/120V areas)
- XC7438-021 (220/240V areas)
- XC7456-021 (U.K.)
- XC7455-021 (Australia, New Zealand)

The above accessories are stored in the accessory bag inside the extension table. These accessories have been designed to help you carry out most sewing tasks.

## USING YOUR SEWING MACHINE

### ⚠ WARNING

- Use only regular household electricity for the power source. Using other power sources may result in fire, electric shock, or damage to the machine.
- Turn off the main power and remove the plug in the following circumstances:
  - When you are away from the machine
  - After using the machine
  - When the power fails during use
  - When the machine does not operate correctly due to a bad connection or a disconnection
  - During electrical storms

### ⚠ CAUTION

- Do not use extension cords or multi-plug adapters with many other appliances plugged in to them. Fire or electric shock may result.
- Do not touch the plug with wet hands. Electric shock may result.
- When unplugging the machine, always turn off the main power first. Always grasp the plug to remove it from the outlet. Pulling on the cord may damage the cord, or lead to fire or electric shock.
- Do not allow the power cord to be cut, damaged, modified, forcefully bent, pulled, twisted, or bundled. Do not place heavy objects on the cord. Do not subject the cord to heat. These things may damage the cord and cause fire or electric shock. If the cord or plug is damaged, take the machine to your authorized dealer for repairs before continuing use.
- Unplug the power cord if the machine is not to be used for a long period of time, otherwise a fire may result.

### Connecting Plugs

- 1 Connect the power cord plug to the machine.
- 2 Connect the power supply plug to a wall outlet.

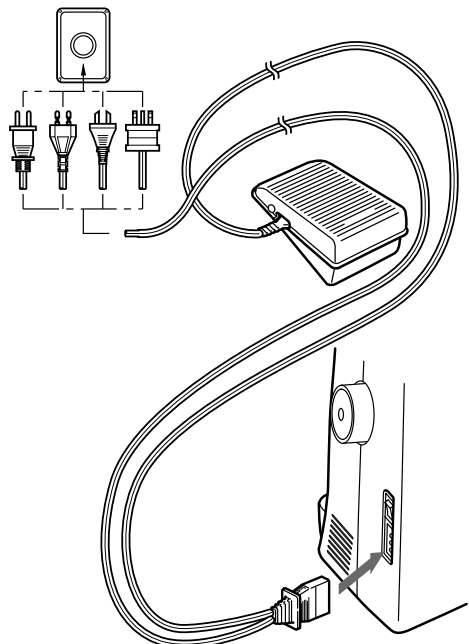



### Note

- When leaving the machine unattended, the main switch of the machine should be switched off or the plug must be removed from the socket outlet.
- When servicing the machine, removing covers or changing bulbs, the machine must be unplugged.

(For U.S.A. only)

- This appliance has a polarized plug (one blade wider than the other). To reduce the risk of electric shock, this plug is intended to fit in a polarized outlet only one way. If the plug does not fit fully in the outlet, reverse the plug.  
If it still does not fit, contact a qualified electrician to install the proper outlet. Do not modify the plug in any way.

## Main Power/Sewing Light Switch

This switch turns the main power and sewing light on or off.

- ① Turn on (toward the "I" mark)
- ② Turn off (toward the "O" mark)

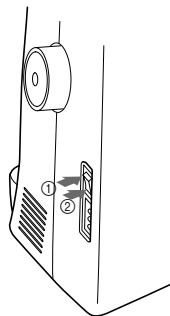

## Foot Controller

When you press the foot controller down lightly, the machine will run at a low speed. When you press harder, the machine's speed will increase. When you take your foot off the foot controller, the machine will stop. You should make sure that nothing is placed on the foot controller when the machine is not in use.

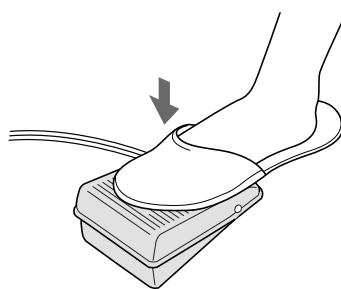

### ⚠ CAUTION

- Do not allow pieces of cloth and dust to build up on the foot controller, otherwise a fire or an electric shock could occur.



### Note

(For U.S.A. only)

- Foot Controller: Model KD-1902  
This foot controller can be used with Models XL-5500/XL-5600/XL-5700/XL-5510/XL-5610/XL-5710.

## Inserting the Needle

### ⚠ CAUTION

- Turn the main power switch off before you change the needle. If you leave the main power on and step on the foot controller, the machine will start and you may be injured.
- Only use sewing-machine needles for home use. Other needles may bend or break and cause injury.
- Never sew with a bent needle. A bent needle will easily break and cause injury.



1 Remove the power supply plug from the electrical outlet.



- 2 Raise the needle bar to its highest position.
- 3 Lower the presser foot.
- 4 If a needle is already installed, remove it by loosening the needle clamp with a screwdriver and pulling the needle down.

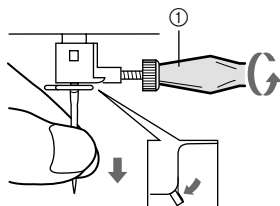

① Screwdriver

- Do not use extreme force when loosening or tightening the needle clamp screw, otherwise certain parts of the sewing machine may be damaged.

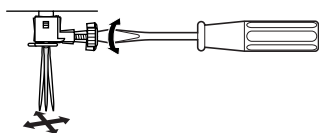

- 5 With the flat side of the needle toward the back of the machine, insert the needle until it touches the needle stopper. Tighten the needle clamp.

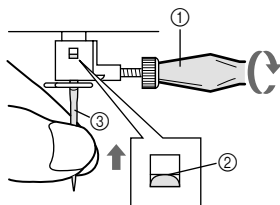

① Screwdriver  
② Needle stopper  
③ Needle

### ⚠ CAUTION

- Make sure to push in the needle until it touches the stopper, and securely tighten the needle clamp screw with a screwdriver. If the needle is not in fully, or if the needle clamp screw is loose, the needle may break or the machine may be damaged.

### Checking the Needle

- 1 The sewing needle must always be straight and sharp for smooth sewing.
- 2 To check if the needle is bent, place the flat side of the needle on a flat surface as shown.

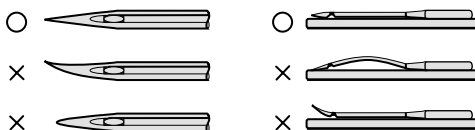

- 3 Replace the needle if it is bent or dull.

### Changing the Presser Foot

#### ⚠ CAUTION

- Always turn off the power before you change the presser foot. If you leave the power on and step on the controller, the machine will start and you may be injured.
- Always use the correct presser foot for the stitch pattern you have chosen. If you use the wrong presser foot, the needle may strike the presser foot and bend or break, and may cause injury.
- Only use presser feet that have been designed to be used with this machine. Using other any presser feet may cause an accident or injury.

You will have to change the presser foot depending on what you want to sew and how.

#### ■ Snap-On Type

- 1 Raise the needle to its highest position by turning the balance wheel toward you (counterclockwise) and raise the presser foot lever.

- 2 Release the foot by raising the lever at the back of the holder assembly.

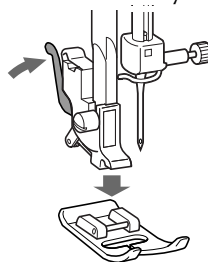

**3** Put a different presser foot on the needle plate so that the bar on the presser foot is in line with the slot on the shank.

**4** Lower the presser foot lever and fix the presser foot onto the shank. If the presser foot is in the correct place, the bar should snap in.

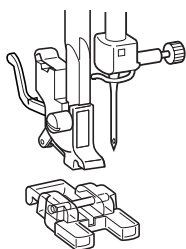
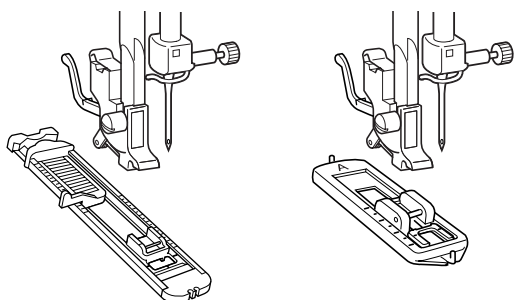
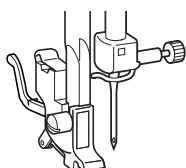
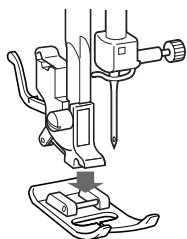

## Converting to Free-arm Style

Free-arm sewing is convenient for sewing tubular and hard-to-reach areas. To change your machine to the free-arm style, lift out the extension table attachment.

- 1 Lift the bottom of the extension table up toward you.
- 2 Pull the extension table out to remove it.

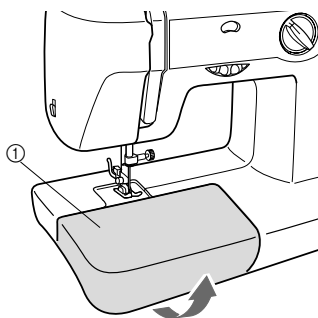

① Extension table

## Steadying the Machine

When the machine is placed on an uneven surface, turn the rubber cushion on the front right-hand side of the base plate to adjust it until the machine is stable.

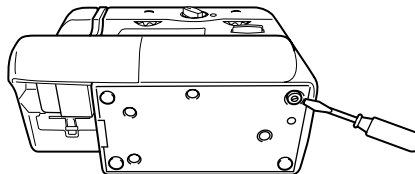

### **CAUTION**

- If the presser foot is not installed with the correct orientation, the needle may strike the presser foot, which may bend or break the needle and cause injury.

# THE CONTROLS

## Pattern Selection Dial

To choose a stitch, simply turn the pattern selection dial in either direction. Stitch widths and lengths are shown on the following page.

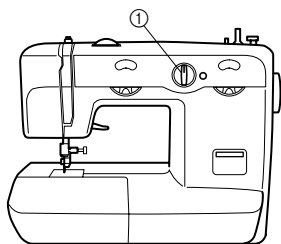

① Pattern selection dial



### Note

- Since the pattern selection dial is not continuous, it cannot be turned directly from the last stitch to the first one or from the first stitch to the last one. To select the first stitch when the last one is displayed or to select the last stitch when the first one is displayed, turn the pattern selection dial in the opposite direction until the desired stitch is displayed.

### ■ 21 Stitches

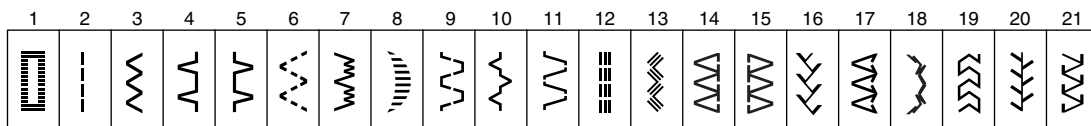

### ■ 17 Stitches

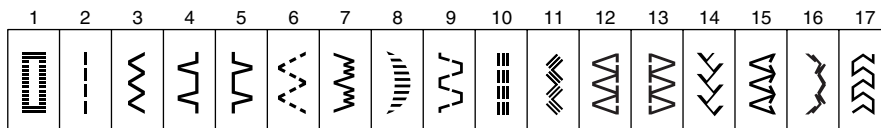

### ■ 15 Stitches

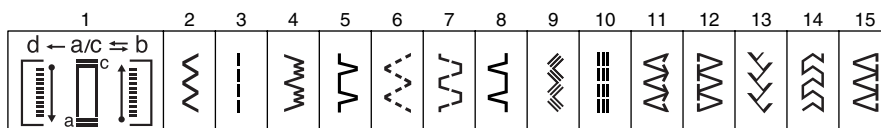

## Recommended Widths and Lengths for Stitches





### ■ 21 Stitches











Pattern	Stitch Name	Recommended Width [mm (inch)]	Recommended Length [mm (inch)]	Page in Instructions
1 	1-STEP AUTOMATIC BUTTONHOLE	3-5 (1/8-3/16)	□-1.5 (1/64-1/16)	30
2 	STRAIGHT STITCH	0-5 (0-3/16) (Changes needle position)	1-4 (1/16-3/16)	25, 34, 35
3 	ZIGZAG STITCH	0-5 (0-3/16)	□-4 (1/64-3/16)	26, 33, 36
4 	BLIND HEM STITCH	3-5 (1/8-3/16)	□-2 (1/64-1/16)	27
5 	SHELL TUCK STITCH	3-5 (1/8-3/16)	□-3 (1/64-1/8)	27
6 	ELASTIC STITCH	3-5 (1/8-3/16)	□-2.5 (1/64-3/32)	28
7 	STRETCH BLIND HEM STITCH	3-5 (1/8-3/16)	□-1.5 (1/64-1/16)	27
8 	SCALLOP STITCH	3-5 (1/8-3/16)	□-1.5 (1/64-1/16)	28
9 	DOUBLE ACTION STITCH	3-5 (1/8-3/16)	□-3 (1/64-1/8)	29
10 	BRIDGING STITCH	3-5 (1/8-3/16)	□-3 (1/64-1/8)	—
11 	RAMPART STITCH	3-5 (1/8-3/16)	□-3 (1/64-1/8)	—
12 	TRIPLE STRETCH STITCH	0-5 (0-3/16) (Changes needle position)	Fixed 2.5 (3/32)	25
13 	TRIPLE ZIGZAG STRETCH STITCH	3-5 (1/8-3/16)	Fixed 2.5 (3/32)	30
14 	STRETCH OVERLOCK STITCH	3-5 (1/8-3/16)	Fixed 2.5 (3/32)	29
15 	ELASTIC OVERLOCK STITCH	3-5 (1/8-3/16)	Fixed 2.5 (3/32)	29
16 	FEATHER STITCH	3-5 (1/8-3/16)	Fixed 2.5 (3/32)	29
17 	ARROWHEAD STITCH	3-5 (1/8-3/16)	Fixed 2.5 (3/32)	29
18 	DECORATIVE STITCH	3-5 (1/8-3/16)	Fixed 2.5 (3/32)	30
19 	LEAF STITCH	3-5 (1/8-3/16)	Fixed 2.5 (3/32)	—
20 	TREE STITCH	3-5 (1/8-3/16)	Fixed 2.5 (3/32)	—
21 	LEGS STITCH	3-5 (1/8-3/16)	Fixed 2.5 (3/32)	—

■ 17 Stitches

Pattern	Stitch Name	Recommended Width [mm (inch)]	Recommended Length [mm (inch)]	Page in Instructions
1 	1-STEP AUTOMATIC BUTTONHOLE	3-5 (1/8-3/16)	□-1.5 (1/64-1/16)	30
2 	STRAIGHT STITCH	0-5 (0-3/16) (Changes needle position)	1-4 (1/16-3/16)	25, 34, 35
3 	ZIGZAG STITCH	0-5 (0-3/16)	□-4 (1/64-3/16)	26, 33, 36
4 	BLIND HEM STITCH	3-5 (1/8-3/16)	□-2 (1/64-1/16)	27
5 	SHELL TUCK STITCH	3-5 (1/8-3/16)	□-3 (1/64-1/8)	27
6 	ELASTIC STITCH	3-5 (1/8-3/16)	□-2.5 (1/64-3/32)	28
7 	STRETCH BLIND HEM STITCH	3-5 (1/8-3/16)	□-1.5 (1/64-1/16)	27
8 	SCALLOP STITCH	3-5 (1/8-3/16)	□-1.5 (1/64-1/16)	28
9 	DOUBLE ACTION STITCH	3-5 (1/8-3/16)	□-3 (1/64-1/8)	29
10 	TRIPLE STRETCH STITCH	0-5 (0-3/16) (Changes needle position)	Fixed 2.5 (3/32)	25
11 	TRIPLE ZIGZAG STRETCH STITCH	3-5 (1/8-3/16)	Fixed 2.5 (3/32)	30
12 	STRETCH OVERLOCK STITCH	3-5 (1/8-3/16)	Fixed 2.5 (3/32)	29
13 	ELASTIC OVERLOCK STITCH	3-5 (1/8-3/16)	Fixed 2.5 (3/32)	29
14 	FEATHER STITCH	3-5 (1/8-3/16)	Fixed 2.5 (3/32)	29
15 	ARROWHEAD STITCH	3-5 (1/8-3/16)	Fixed 2.5 (3/32)	29
16 	DECORATIVE STITCH	3-5 (1/8-3/16)	Fixed 2.5 (3/32)	30
17 	LEAF STITCH	3-5 (1/8-3/16)	Fixed 2.5 (3/32)	—

■ 15 Stitches

Pattern	Stitch Name	Recommended Width [mm (inch)]	Recommended Length [mm (inch)]	Page in Instructions
1 	4-STEP BUTTONHOLE	3-5 (1/8-3/16)	□-1.5 (1/64-1/16)	31
2 	ZIGZAG STITCH	0-5 (0-3/16)	□-4 (1/64-3/16)	26, 33, 36
3 	STRAIGHT STITCH	0-5 (0-3/16) (Changes needle position)	1-4 (1/16-3/16)	25, 34, 35
4 	STRETCH BLIND HEM STITCH	3-5 (1/8-3/16)	□-1.5 (1/64-1/16)	27

5		SHELL TUCK STITCH	3-5 (1/8-3/16)	□-3 (1/64-1/8)	27
6		ELASTIC STITCH	3-5 (1/8-3/16)	□-2.5 (1/64-3/32)	28
7		DOUBLE ACTION STITCH	3-5 (1/8-3/16)	□-3 (1/64-1/8)	29
8		BLIND HEM STITCH	3-5 (1/8-3/16)	□-2 (1/64-1/16)	27
9		TRIPLE ZIGZAG STRETCH STITCH	3-5 (1/8-3/16)	Fixed 2.5 (3/32)	30
10		TRIPLE STRETCH STITCH	0-5 (0-3/16) (Changes needle position)	Fixed 2.5 (3/32)	25
11		ARROWHEAD STITCH	3-5 (1/8-3/16)	Fixed 2.5 (3/32)	29
12		ELASTIC OVERLOCK STITCH	3-5 (1/8-3/16)	Fixed 2.5 (3/32)	29
13		FEATHER STITCH	3-5 (1/8-3/16)	Fixed 2.5 (3/32)	29
14		LEAF STITCH	3-5 (1/8-3/16)	Fixed 2.5 (3/32)	—
15		STRETCH OVERLOCK STITCH	3-5 (1/8-3/16)	Fixed 2.5 (3/32)	29

## Stitch Length Dial

Depending on the selected stitch, you may need to adjust the stitch length for best results. The numbers marked on the stitch length dial represent the stitch length in millimeters (mm) (1/25").

THE HIGHER THE NUMBER, THE LONGER THE STITCH. With the "0" setting material is not fed. This is used when sewing on a button.

The "□" range is for making a satin stitch (close zigzag stitch), which is used for making buttonholes and decorative stitches. The position needed for making the satin stitch varies according to the material and thread being used. To determine the exact dial position, first test the stitch and length settings on a scrap piece of fabric to observe the feeding of the material.

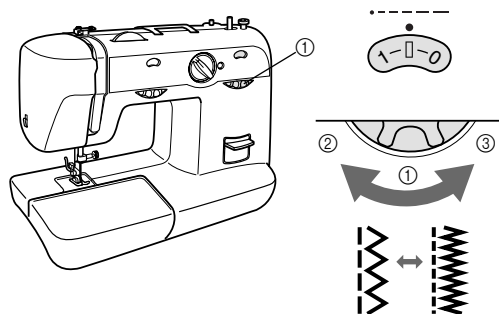

- ① Stitch length dial
- ② Longer
- ③ Shorter

## ⚠ CAUTION

- If the stitches are bunched together, lengthen the stitch length and continue sewing. Do not continue sewing without lengthening the stitch length, otherwise the needle may break and cause injury.

## Stretch Stitching

### ■ Selecting a stretch stitch

Setting the stitch length dial to "SS" changes the selected pattern to a stretch stitch.

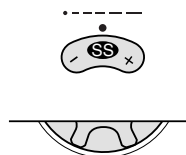

### ■ Adjusting the stretch stitching

The machine is adjusted at the factory so that the stretch stitching can be sewn with the stitch length dial set to "SS" (standard position).

If different types of fabric or thread are used or the pattern does not have the correct shape, turn the dial toward either "+" or "-" to adjust the stitch.

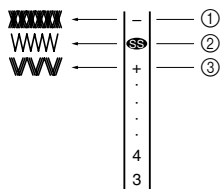

- ① Makes fine stitches
- ② Standard position
- ③ Makes rough stitches



**Note**

- The dial cannot be turned past "... + SS -". Do not forcefully turn the stitch length dial out of the allowable range.

### Stitch Width Dial

Depending on the stitch selected, you may need to adjust the stitch width. The numbers marked on the dial represent the stitch width. THE HIGHER THE NUMBER, THE WIDER THE STITCH.

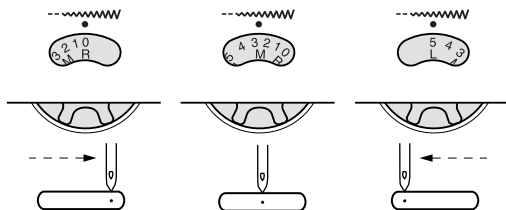
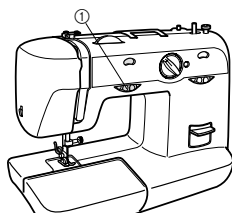

① Stitch width dial



**Note**

- When the Straight or Triple Stretch Stitches are selected, the needle position can be changed from left to right.
- When the Straight or Triple Stretch Stitches are selected, the needle position can be changed by adjusting the stitch width dial.

### Reverse Sewing Lever

You can use reverse sewing for backtacking and reinforcing seams.

To sew in reverse, push the reverse sewing lever in as far as possible and hold it in that position while you lightly push the foot controller. To sew forward, release the reverse sewing lever. The machine will then sew forward.

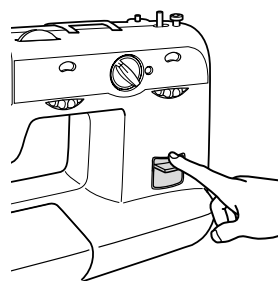

### Drop Feed Lever (if the machine is equipped with a drop feed lever)

Use the drop feed lever to raise or lower the feed dogs according to the job that is being done. When monogramming, embroidering, darning or sewing on buttons, the feed dogs should be lowered so that the garment will not be fed.

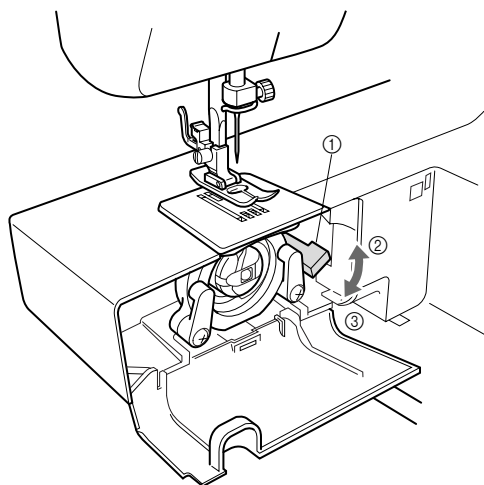

- ① Drop feed lever
- ② Up position: Feed dogs are down.
- ③ Down position: Feed dogs are up.

# THREADING THE MACHINE

## Winding the Bobbin

### CAUTION

- Only use the bobbin (part code: SA156, SFB (XA5539-151)) that has been designed for this sewing machine. Using of any other bobbin may cause damage to the machine.
- The bobbin was designed specifically for this sewing machine. If bobbins from older models are used, the machine will not operate correctly. Use only the enclosed bobbin or bobbins of the same type (part code: SA156, SFB (XA5539-151)).

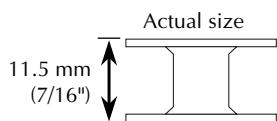

- 1 Put the spool of thread on the spool pin and pass the thread around the bobbin-winding tension disc.

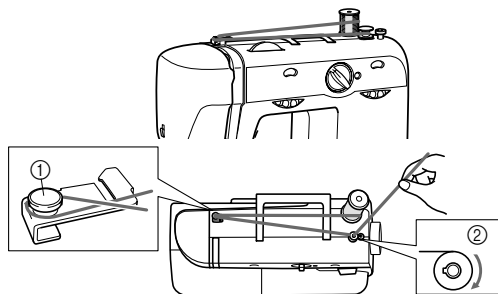

- 1 Bobbin-winding tension disc
- 2 Bobbin-winding shaft

### CAUTION

- If the spool of thread is not in the right place, the thread may tangle on the spool pin.

- 2 Pass the end of the thread through the hole on the bobbin from the inside of the bobbin.
- 3 Put the bobbin onto the bobbin-winding shaft and slide the bobbin-winding shaft to the

right. Turn the bobbin clockwise, by hand, until the spring slides into the slit.

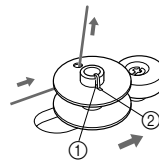

- 1 Spring
- 2 Slit

- 4 While holding the end of the thread, gently press the foot controller to wind the thread around the bobbin a few times. Then, stop the machine.

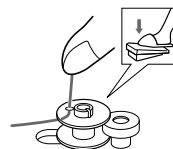

- 5 Trim the excess thread above the bobbin and continue winding the thread onto the bobbin by pressing the foot controller.

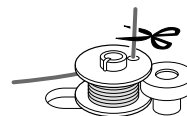

### Note

- The machine stops automatically when the bobbin is full.

- 6 After the machine stops, cut the thread, slide the shaft to the left, and then remove the bobbin.



### Note

- The needle bar does not move after the bobbin-winding shaft is slid to the right.
- Immediately after winding the bobbin, it is normal to hear the sound of the clutch engaging when beginning to sew or turning the balance wheel.



**CAUTION**

- Make sure you follow the instructions carefully. If you do not cut the thread completely, and the bobbin is wound, when the thread runs low it may tangle around the bobbin and cause the needle to break.

**CAUTION**

- Setting the bobbin improperly may cause the thread tension to loosen, and may break the needle.

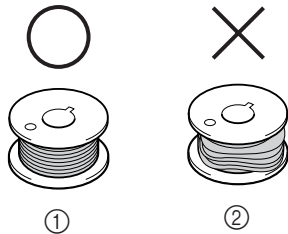

- ① Wound evenly
- ② Wound poorly

**Lower Threading**

**CAUTION**

- Setting the bobbin improperly may cause the thread tension to loosen, breaking the needle and resulting in injury.

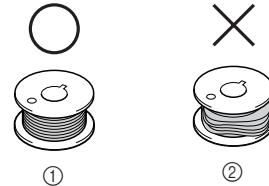

- ① Wound evenly
- ② Wound poorly

- The bobbin was designed specifically for this sewing machine. If bobbins from older models are used, the machine will not operate correctly. Use only the enclosed bobbin or bobbins of the same type (part code: SA156, SFB (XA5539-151)).

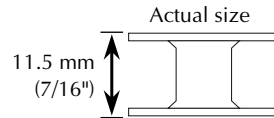

**CAUTION**

- Make sure you turn the power off while threading the machine. If you accidentally step on the foot controller and the machine starts to work, you could be injured.

- 1 Raise the needle to its highest position by turning the balance wheel toward you (counterclockwise) and raise the presser foot lever.
- 2 Open the shuttle cover behind the extension table on the front of the machine and pull the bobbin case out of the shuttle race by pulling the latch toward you.

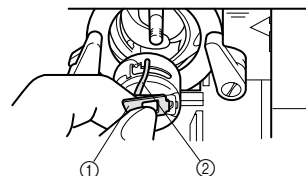

- ① Bobbin case latch
- ② Bobbin case finger

- 3** Unwind about 10 cm (4") of thread from a full bobbin and insert the bobbin into the bobbin case. (See fig. A-1.) Pull the trailing thread into the slot, then down and to the left, as shown in fig. A-2, until it enters the delivery eye under the tension spring (fig. A-3).

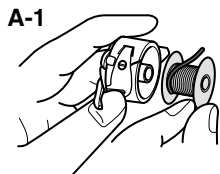

A-2



A-3

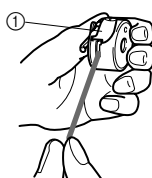

① Tension spring

### **! CAUTION**

- Make sure you set the bobbin so the thread unrolls in the correct direction. If the thread unrolls in the wrong direction, it may cause the thread tension to be incorrect or break the needle.

- 4** Holding the bobbin case by the latch, fully insert the bobbin case into the shuttle race and release the latch. Make sure the bobbin case finger fits into the notch at the top of the race.

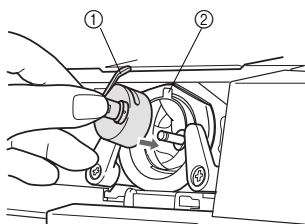

① Bobbin case finger  
② Notch



### **Note**

- If the bobbin case is not properly placed back into the machine, it will fall out from the shuttle immediately after you start sewing.

### **! CAUTION**

- To reduce the risk of injury from moving parts, be sure to turn off the machine before servicing it. In addition, be sure to close the shuttle cover.

## Upper Threading

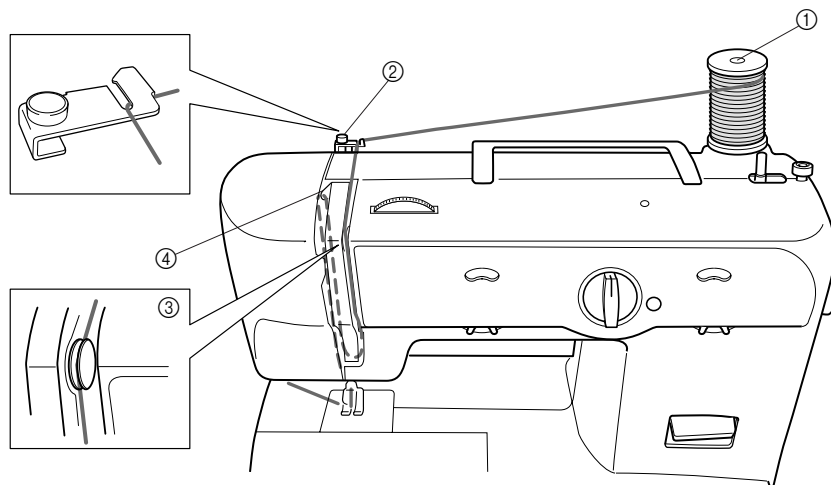

- ① Spool pin
- ② Thread guide

- ③ Tension discs
- ④ Thread take-up lever

### ⚠ CAUTION

- Make sure you thread the machine properly, otherwise the thread could tangle and break the needle.

Set the main power switch to "O".

- 1** Raise the presser foot lever and turn the balance wheel toward you (counterclockwise) to raise the thread take-up lever to its highest position.
- 2** Pull up the spool pin and put a spool of thread on this pin.

### ⚠ CAUTION

- If the spool of thread is in the wrong place, or is set incorrectly, the thread may tangle on the spool pin and cause the needle to break.

- 3** Pass the thread through guides.

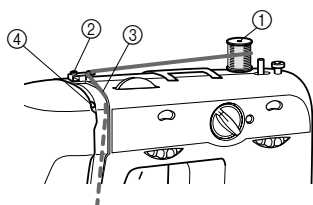

- ① Spool pin
- ② Thread guide
- ③ Tension discs
- ④ Thread take-up lever

- 4** While holding the thread, pull it between the tension discs.

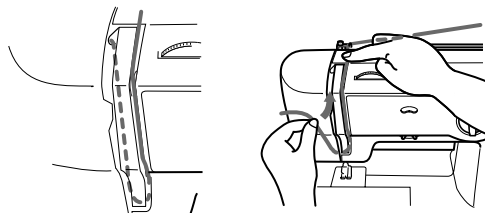

- 5** Guide the thread to the back of the thread take-up lever and around to the left. Bring the thread through the slit by pulling it toward you and into the eyelet.

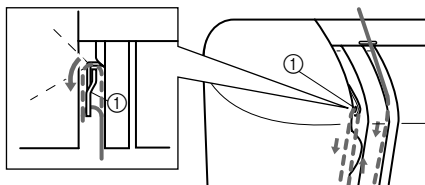

- ① Thread take-up lever

- 6** Bring the thread down and pass it behind the thread guide.

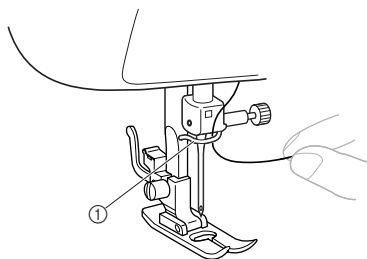

① Thread guide

- 7** Thread the needle from front to back and pull out about 5 cm (2") of thread.

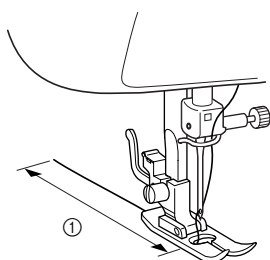

① 5 cm (2inch)



### Note

- If the thread take-up lever is lowered, the upper thread cannot be wrapped around the thread take-up lever. Make sure you raise the presser foot lever and the thread take-up before you feed the upper thread.
- If you incorrectly feed the thread you may cause sewing problems.

## Using the Needle Threader (models equipped with a needle threader)

Set the main power switch to "O".

- 1** Lower the presser foot lever.

- 2** Turn the balance wheel toward you (counterclockwise) until the bottom of the needle holder aligns with the bottom of the needle-threading-hook holder.

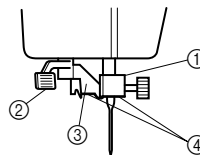

- ① Needle holder
- ② Needle threader lever
- ③ Hook holder
- ④ Align



### Note

- When you use the needle threader, make sure to align the bottom of the needle holder with the bottom of the holder for the needle-threading hook before lowering the needle threader lever, otherwise the hook may be damaged.

- 3** While lowering the needle threader lever, hook the thread onto the guide.

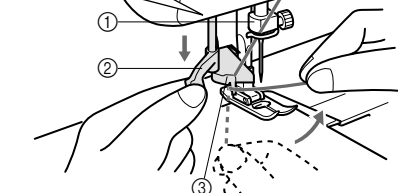
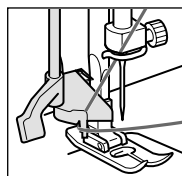

- ① Needle holder
- ② Needle threader lever
- ③ Guide

- 4** Pull down the needle threader lever as much as possible, and then turn the lever toward the back of the machine (away from you). Make sure that the hook passes through the eye of the needle and grabs the thread.

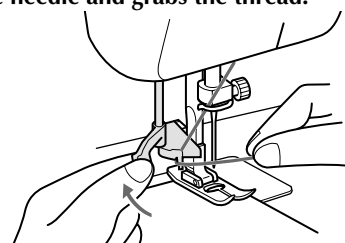

- Hold the thread in front of the needle to make sure that the hook grabs it.

- 5** While lightly holding the thread, turn the needle threader lever toward the front of the machine (toward you). The hook will pull the thread through the needle.

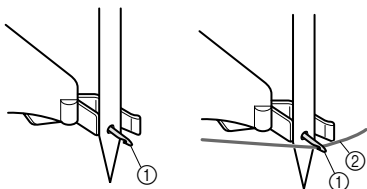

- ① Hook  
② Thread

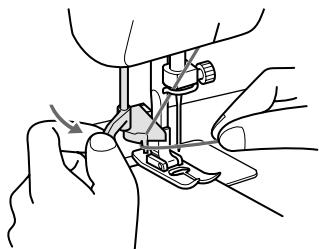

- 6** Raise the needle threader lever and pull out about 5 cm (2") of thread through the needle toward the back of the sewing machine.

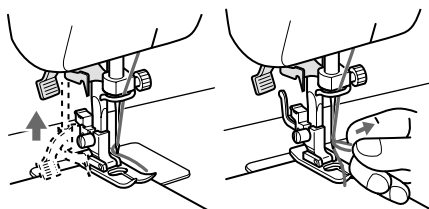

**! CAUTION**

- The needle threader can only be used with home sewing machine needles size 75/11-100/16. Check the table on page 24 for the appropriate needle and thread combinations. If you are using transparent nylon mono-filament thread, you can only use needles in the range of 90/14-100/16.
- You cannot use the needle threader if you are using decorative threads or speciality needles, such as the twin needle and wing needle. If you are using these types of threads or needles, thread the needle by hand. Make sure the main power switch is off when threading the needle by hand.

**Quick Thread-Setting System FAST START BOBBIN**  
(models equipped with a quick thread-setting system)

This new system allows you to start sewing immediately after inserting the bobbin without pulling up the lower thread. You can, however, draw up the lower thread as explained in "Drawing up the lower thread" if you wish.

Set the main power switch to "O".

- 1** Hold the end of the bobbin thread and insert the bobbin case into the shuttle.

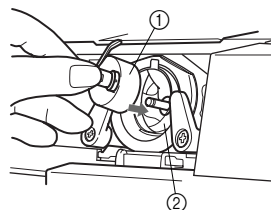

- ① Bobbin case  
② Shuttle

- 2** Close the shuttle cover while pulling the thread through the slit in the cover.

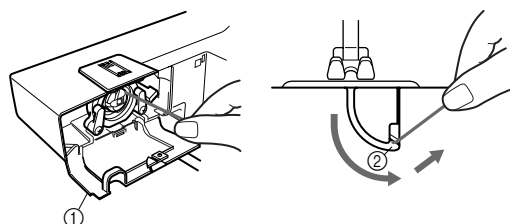

- ① Shuttle cover  
② Slit

- 3** Slide the thread down to the bottom of the slit, pull it up, and then cut it on the cutter to complete the lower threading.

- 4** Pull out about 15 cm (6") of the upper thread as usual, and then pull it between the toes of the presser foot and straight toward the back of the machine.

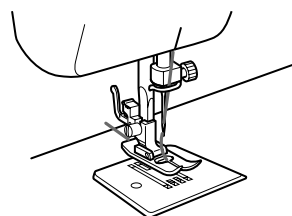

- 5** Start sewing as usual. (It is not necessary to draw up the bobbin thread.) (Refer to page 21.)

## Drawing up the lower thread

- 1 Raise the presser foot and the needle to their highest positions.

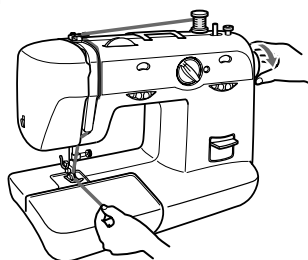

- 2 While lightly holding the end of the upper thread, slowly turn the balance wheel to the front (counterclockwise) once by hand to lower, then raise the needle.

- 3 The upper thread should have caught the lower thread in a loop. Pull on the upper thread to draw up the lower thread.

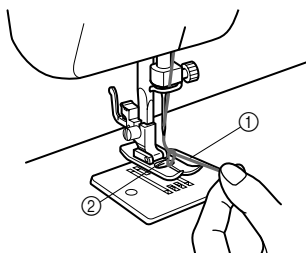

- ① Upper thread
- ② Lower thread loop

- 4 Pull out about 15 cm (6") of both threads and put them toward the back of the machine under the presser foot. The upper thread should pass between the toes of the presser foot.

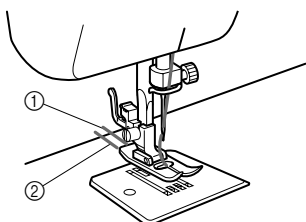

- ① Upper thread
- ② Lower thread

## Sewing with a Twin Needle

We have designed your machine so you can sew with this needle and two top threads. You can use the same color or two different colors of thread for making decorative stitches.

### ⚠ CAUTION

- Use only twin needles that have been made for this machine (part code: X57521-001). Other needles could break, and damage the machine.
- When using the twin needle, make sure the stitch width dial is not set above "3" since this may cause the needle to hit the needle plate and break.
- Do not sew with bent needles. The needle could break and cause injuries.
- When using the twin needle, make sure you use the zigzag presser foot only.

### ■ Attaching the Twin Needle

Attach the twin needle in the same way as a single needle (see page 7). The flat side of the needle should face toward the back and the rounded side should face toward you.

### ■ Attaching the Extra Spool Pin

Put the extra vertical spool pin in the hole on the top right-hand side of the machine. Put the second spool of thread onto the extra spool pin.

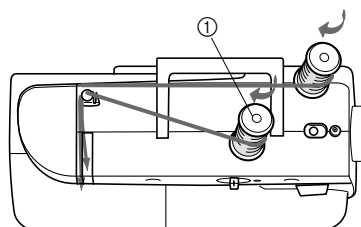

- ① Extra spool pin

## ■ Twin Needle Threading

You should thread each needle separately.

### 1 Threading the Right Needle

Follow the same instructions for threading a single needle. See page 18 for more details.

### 2 Threading the Left Needle

Thread the left needle in the same way that you threaded the right needle using the thread from the spool on the extra spool pin, but do not pass the thread through the thread guide above the needle before you pass it through the eye of the left needle.

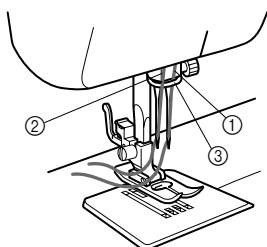

- ① Right needle thread passes through thread guide
- ② Left needle thread passes in front of thread guide
- ③ Thread guide



### Note

#### Models that are equipped with a Needle Threader

- You cannot use the needle threader to thread the twin needle. Instead, thread the twin needle by hand, from front to back. Using the needle threader may damage the machine.

## Tension of the Thread

The tension of the thread will affect the quality of your stitches. You may need to adjust it when you change fabric or thread.



### Memo

- We recommend that you sew a scrap piece of fabric to check the thread tension before sewing on your project.
- The basic thread tension setting is "5".

## ■ Possible Problems If the Tension Is Wrong

### Upper tension is too tight.

Locks will appear on the surface of the fabric.

#### Upper tension control dial

Decrease the tension by turning the dial to a lower number.

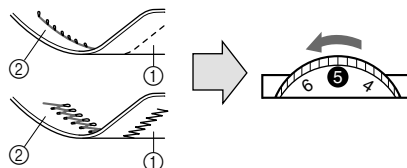

- ① Reverse
- ② Surface

### Upper tension is too loose.

Locks appear on the reverse side of the fabric.

#### Upper tension control dial

Increase the tension by turning the dial to a higher number.

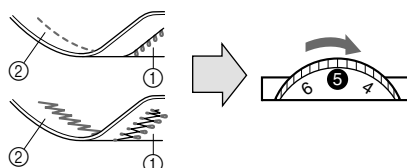

- ① Reverse
- ② Surface



### Note

- The lower thread tension has been adjusted at the factory for general use. For most sewing applications, no adjustment is needed. When sewing with thin thread on thin fabrics, the thread tension cannot be adjusted adequately with the upper tension control dial. Instead, the thread tension must be adjusted according to the procedure described below.

### Lower tension is too loose.

Locks appear on the surface of the fabric.

Decrease the thread tension by turning the dial to a lower number. If the result is still not satisfactory, then adjust the bobbin thread tension as explained below.

#### Bobbin

Increase the tension in the bobbin by turning the screw with a small screwdriver in a clockwise direction. However, do not turn the screw more than one full turn.

Remember to return the screw to its original position before starting your next project.

### Correct tension

Correct tension is important as too much or too little tension will weaken your seams or cause puckers on your fabric.

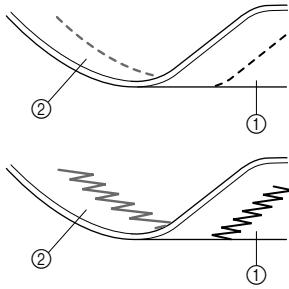

- ① Reverse
- ② Surface



## CHART OF SEWING FABRICS, NEEDLES AND THREAD COMBINATIONS

Fabric Type		Thread		Size of Needle
		Type	Size	
Medium-weight fabrics	Broadcloth	Cotton	60–80	75/11–90/14
	Taffeta	Synthetic mercerized		
	Flannel, Gabardine	Silk or silk finished	50–80	
Lightweight fabrics	Lawn, Batiste	Cotton	60–80	75/11
	Georgette	Synthetic mercerized		
	Challis, Satin	Silk	50–80	
Heavy-weight fabrics	Denim	Cotton	30–50	90/14–100/16
	Corduroy	Synthetic mercerized	50	
	Tweed	Silk		
Stretch fabrics	Jersey	Thread for knits	50–60	Ball-point needle (golden colored) 75/11–90/14
	Tricot			
For top-stitching		Synthetic mercerized	30	90/14–100/16
		Silk		



### Note

- Select the correct needle and thread size from the above chart.
- Use the same size thread for the upper (spool) and lower (bobbin) threads.
- For clear nylon thread, always use needle 90/14 - 100/16.



### CAUTION



- Make sure you follow the needle, thread, and fabric combinations listed in the table. Using the wrong combination, for example, using heavyweight fabric such as denim with a small needle (for example, 75/11) may bend or break the needle. Also, the seam may be uneven, the fabric may pucker, or the machine may skip stitches.

## Please Read Before Sewing

### **!** CAUTION

- To avoid being injured, watch the needle carefully while you are using the machine. Keep your hands away from moving parts.
- Do not stretch or pull the fabric during sewing, otherwise the needle may be damaged and you may be injured.
- Do not use bent or broken needles, otherwise you may be injured.
- Take care that the needle does not hit basting pins or other objects during sewing, otherwise the needle may break and you may be injured.
- Always use the correct presser foot. If you use the wrong presser, the needle may hit the presser foot and bend or break and you may also be injured.
- When you turn the balance wheel by hand, always turn it toward the front of the machine (counterclockwise). Turning it the other way may cause the thread to tangle and damage the needle or fabric. You may also be injured.

## Straight Stitching

Stitch Name	Pattern	Stitch Length [mm (inch)]	Stitch Width [mm (inch)]
Straight Stitch		1-4 (1/16-3/16)	5-0* (3/16-0)
Triple Stretch Stitch		Fixed 2.5 (3/32)	

\*Turn the stitch width dial to adjust the needle position. Setting the dial to "5" selects the left needle position; setting the dial to "0" selects the right needle position.

### ■ Starting Sewing

- 1 Turn the pattern selection dial to choose the Straight Stitch or Triple Stretch Stitch.
- 2 Raise the needle to its highest position and lift the presser foot lever.
- 3 Pull up the lower thread by turning the balance wheel toward you (counterclockwise), and place both the upper and lower threads behind the presser foot.
- 4 Put the fabric under the presser foot and position the needle 1 cm (3/8") from the edge of the fabric.
- 5 Lower the presser foot.

### ■ Backtacking

- 6 Press the reverse sewing lever down as far as possible, and then lightly step on the foot controller. Sew 5 to 10 stitches in the reverse direction.
- 7 Release the reverse sewing lever and start sewing in the forward direction by pressing the foot controller.

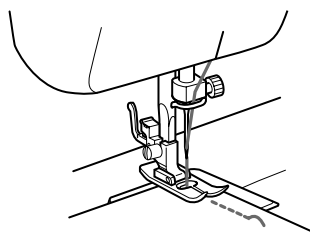

- You can use reverse sewing for locking the end of seams and where you need to strengthen a stitch.

### **!** CAUTION

- Make sure the needle does not hit a pin or any other object during sewing. The thread could tangle or the needle could break. You could also be injured.

### ■ Changing Sewing Direction

- 1 With the needle still in the fabric, stop the machine at the point where you want to change the sewing direction.

- 2 Raise the presser foot and turn the fabric to its new direction using the needle as a turning point for the fabric.

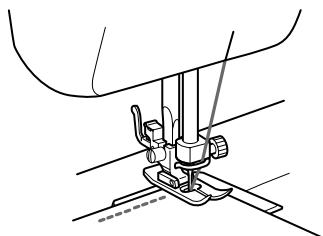

- 3 Lower the presser foot and continue sewing in the new direction.

■ Finishing Sewing

- 1 Stitch to the end of the seam and stop.
- 2 Push the reverse sewing lever and stitch backwards for 1 cm (3/8") from the end of the fabric.

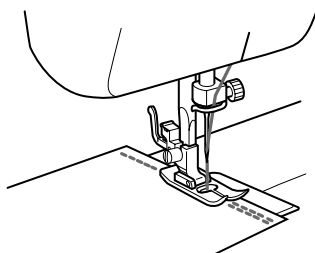

■ Removing the Material from the Machine

- 1 Stop the machine. Raise the needle to its highest position and make sure that the thread take-up lever is also at its highest position.
- 2 Lift the presser foot and pull the fabric out gently to the left-hand side.
- 3 Cut both threads with the thread cutter on the left-hand side of the machine.

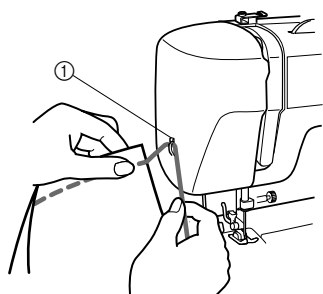

① Thread cutter

- 4 To prepare the machine for the next seam, pull about 10 cm (4") of thread through the toes of the presser foot toward the back of the machine.

■ Top-Stitching and Stretch Materials

You can use the Straight Stitch for top-stitching and sewing lightweight fabrics. You can use Triple Stretch Stitch for sewing stretch fabrics.

Zigzag Stitching

Stitch Name	Pattern	Stitch Length [mm (inch)]	Stitch Width [mm (inch)]
Zigzag Stitch		□-4 (1/64-3/16)	0-5 (0-3/16)

■ Zigzag Stitch

Turn the pattern selection dial to the Zigzag Stitch, and then select the stitch length and the stitch width.

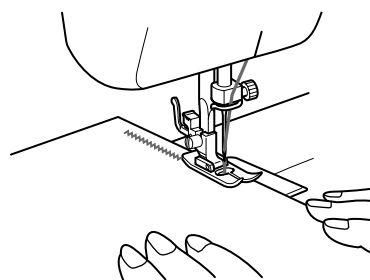

We recommend that you sew using the Straight Stitch at the beginning and end of the zigzag stitches.

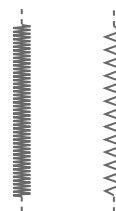

■ SATIN STITCH

Setting the Zigzag Stitch length in the "□" range produces a satin stitch (close zigzag stitch). The satin stitch can be used for making buttonholes and decorative stitches. Set the pattern selection dial to the Zigzag Stitch, set the stitch length in the "□" range, and set the stitch width dial between "0" and "5".

## Blind Hem Stitching

Stitch Name	Pattern	Stitch Length [mm (inch)]	Stitch Width [mm (inch)]
Blind Hem Stitch		-2 (1/64-1/16)	3-5 (1/8-3/16)
Stretch Blind Hem Stitch		-1.5 (1/64-1/16)	3-5 (1/8-3/16)

You can use the Blind Hem Stitch to finish the edge of a project, like the hem of a pair of trousers, without the stitch showing. Use the Blind Hem Stitch when sewing on non-stretch fabrics, and the Stretch Blind Hem Stitch for stretch fabrics.

- Both threads should be the same color as the fabric.
- Fold back the hem, as shown in fig. A. Then fold the edge of the fabric as in fig. B. Leave a 6 mm (15/64") overlap at the edge.
- Set the pattern selection dial to the Blind Hem Stitch or Stretch Blind Hem Stitch, and then set the stitch length.
- Sew on the fold as in fig. C.

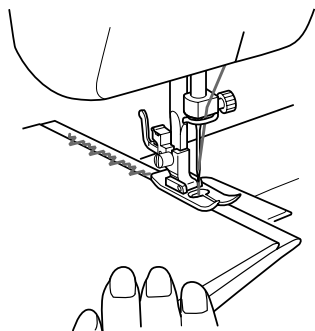

- When the fabric is unfolded you will have a blind hem stitch as shown in fig. D.

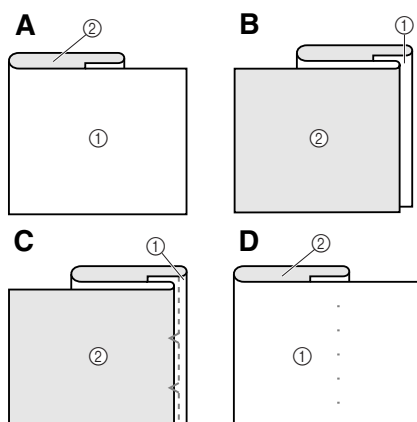

- ① Right side of fabric  
② Wrong side of fabric



### Note

- The Stretch Blind Hem Stitch is useful for stretch fabrics.

## Shell Tuck Stitching

Stitch Name	Pattern	Stitch Length [mm (inch)]	Stitch Width [mm (inch)]
Shell Tuck Stitch		-3 (1/64-1/8)	3-5 (1/8-3/16)

The Shell Tuck Stitch can be used to sew a picot (lace-like) edge on lightweight fabric.

- Set the pattern selection dial to the Shell Tuck Stitch.
- Adjust the thread tension so that it is tighter than normal.
- Place the fabric under the presser foot so that it will be sewn along the bias with the straight stitches sewn on the seamline and the zigzag stitches sewn slightly over the folded edge.
- Sew at a slow speed.

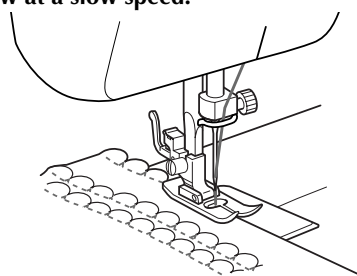

## Elastic Stitching

Stitch Name	Pattern	Stitch Length [mm (inch)]	Stitch Width [mm (inch)]
Elastic Stitch		□ -2.5 (1/64-3/32)	3-5 (1/8-3/16)

You can use the Elastic Stitch for mending, sewing elastic or joining fabric. Each is explained below. Set the pattern selection dial to the Elastic Stitch.

### ■ Mending

- 1 Set the stitch length dial between "□" and "2.5".
- 2 Place the reinforcement fabric under the area you want to mend.
- 3 Following the line of the tear, sew using the Elastic Stitch as illustrated.

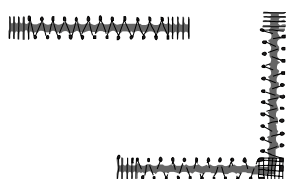

### ■ Sewing Elastic

- 1 Place the elastic on the fabric.
- 2 As you sew, stretch the elastic in front of and behind the presser foot.

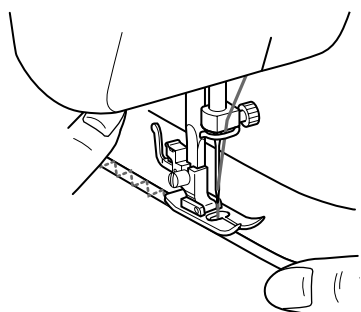

### ■ Joining Fabric

You can use the Elastic Stitch to join two pieces of fabric together. In addition, it is very effective when sewing knitted fabrics. If you are using nylon thread, the stitch will not be visible.

- 1 Put the edge of the two pieces of fabric together and center them under the presser foot.
- 2 Sew them together using the Elastic Stitch. Make sure you keep the two fabric edges close together.

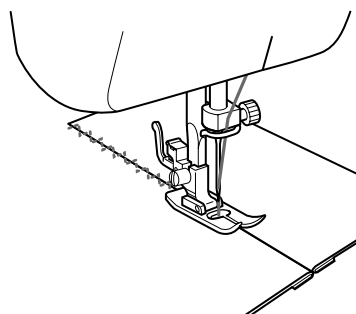

## Scallop Stitching

Stitch Name	Pattern	Stitch Length [mm (inch)]	Stitch Width [mm (inch)]
Scallop Stitch		□ -1.5 (1/64-1/16)	3-5 (1/8-3/16)

This machine automatically produces a Scallop Stitch for decorative edging.

- 1 Set the pattern selection dial to the Scallop Stitch.
- 2 Sew the Scallop Stitch along the edge of the material.
- 3 If desired, trim around the scallop with scissors to create a scalloped edge. Be careful not to cut the thread.

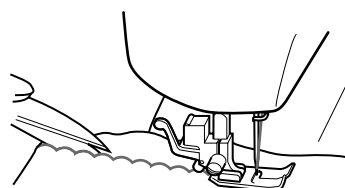



## Double Action Stitching

Stitch Name	Pattern	Stitch Length [mm (inch)]	Stitch Width [mm (inch)]
Double Action Stitch		□ -3 (1/64-1/8)	3-5 (1/8-3/16)

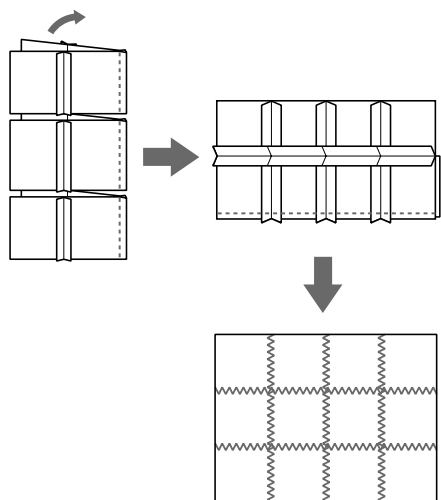
This stitch is used for joining two pieces of fabric, for example, when making patchwork. Set the pattern selection dial to the Double Action Stitch.



## Overedge Stitching

Stitch Name	Pattern	Stitch Length [mm (inch)]	Stitch Width [mm (inch)]
Stretch Overlock Stitch		Fixed 2.5 (3/32)	3-5 (1/8-3/16)
Elastic Overlock Stitch			3-5 (1/8-3/16)
Arrowhead Stitch			

You can use these stitches to join together seams and finish them in one operation. The Overlock Stitches are also useful for sewing stretch materials while the Arrowhead Stitch is ideal for sewing the edge of a blanket.

- 1 Set the pattern selection dial to the Elastic Overlock, Stretch Overlock or Arrowhead.

- 2 Put the fabric under the presser foot so that the seamline (or arrowhead point) is approximately 3 mm (1/8") to the left of the center of the presser foot. This stitch works best with a seam allowance of approximately 6 mm (1/4") as this allows the right (zigzag) side of the stitch to overlock the cut edge of the fabric.

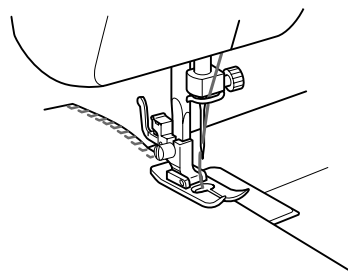

- 3 If the seam allowance is wider than the stitch pattern, trim away any excess fabric after stitching.

A finished Elastic Overlock Stitch is shown in the diagram below.

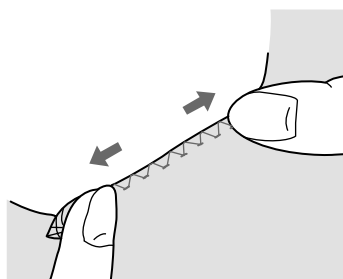

## Feather Stitching

Stitch Name	Pattern	Stitch Length [mm (inch)]	Stitch Width [mm (inch)]
Feather Stitch		Fixed 2.5 (3/32)	3-5 (1/8-3/16)

Use the Feather Stitch as a decorative top-stitch when hemming blankets, tablecloths or draperies, or when embroidering.

- 1 Set the pattern selection dial to the Feather Stitch.
- 2 Place the fabric right side up and sew 1 cm (3/8") from the edge of the fabric.
- 3 Trim close to the stitching.

The stitch will prevent the fabric from unravelling.

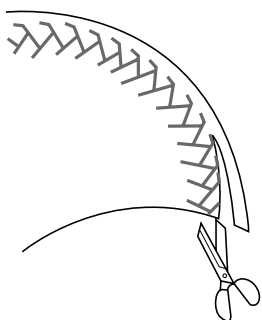

### Triple Zigzag Stretch Stitching

Stitch Name	Pattern	Stitch Length [mm (inch)]	Stitch Width [mm (inch)]
Triple Zigzag Stretch Stitch		Fixed 2.5 (3/32)	3-5 (1/8-3/16)

This stitch can be used wherever a Zigzag Stitch would be used to sew heavyweight stretch fabrics. The Triple Zigzag Stretch Stitch can also be used as a decorative top-stitch. Set the pattern selection dial to the Triple Zigzag Stretch Stitch.

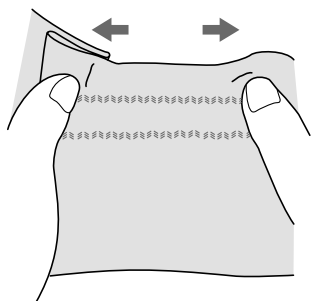

### Decorative Stitching

Stitch Name	Pattern	Stitch Length [mm (inch)]	Stitch Width [mm (inch)]
Decorative Stitch		Fixed 2.5 (3/32)	3-5 (1/8-3/16)

This stitch can be used for decorative stitching.

### Making a Buttonhole (1-Step Automatic Buttonhole)

Pattern	Stitch Length [mm (inch)]	Stitch Width [mm (inch)]	Foot
 (1-Step Automatic Buttonhole)	-1.5 (1/64-1/16)	3-5 (1/8-3/16)	Buttonhole Foot

#### Memo

- We recommend that you practice making a buttonhole on a scrap piece of fabric before you try it on the actual garment.
- When making buttonholes on soft fabrics, place stabilizer material on the underside of the fabric.

Making a buttonhole is a simple process that provides reliable results.

#### ■ Making a Buttonhole

- 1 Using tailor's chalk, mark the position and length of the buttonhole on the fabric.
- 2 Attach the buttonhole foot and set the pattern selection dial to "□".
- 3 You need to sew the front bar tack first. Lower the presser foot to align the marks on the foot with the mark on the fabric.
- 4 Open the button plate and insert the button.

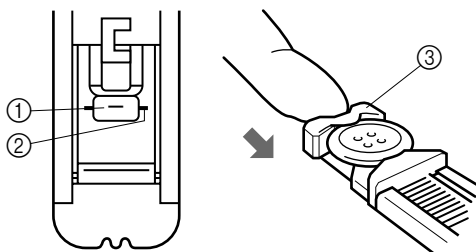

- ① Starting mark on the fabric
- ② Marks on the foot
- ③ Button plate

- 5** Lower the buttonhole lever and push it back slightly.

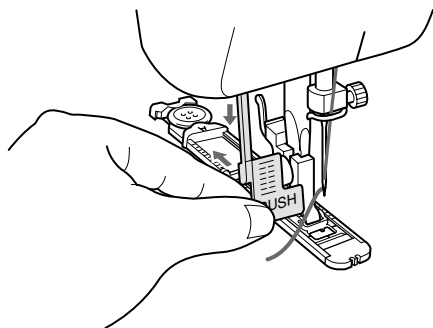

- 6** While gently holding the upper thread, start the machine.

- 7** The bar tacks of the buttonhole are sewn in the order shown.

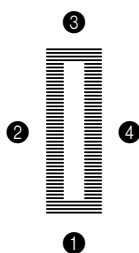

- 8** Stop the machine when buttonhole stitching is finished.

#### ■ Making a Buttonhole on Stretch Fabrics

When sewing buttonholes on stretch fabric, the buttonhole stitching is sewn over a gimp thread.

- 1** Using tailor's chalk, mark the position of the buttonhole on the fabric, and then attach the buttonhole foot and set the pattern selection dial to "□".

- 2** Hook the gimp thread onto the back end of the buttonhole foot, bring the two gimp thread ends to the front of the foot, insert them into the grooves, and then temporarily tie them there.

- 3** Lower the presser foot and start sewing.  
\*Set the stitch width to match the diameter of the gimp thread.

- 4** Once sewing is completed, gently pull the gimp thread to remove any slack, and then trim off the excess.

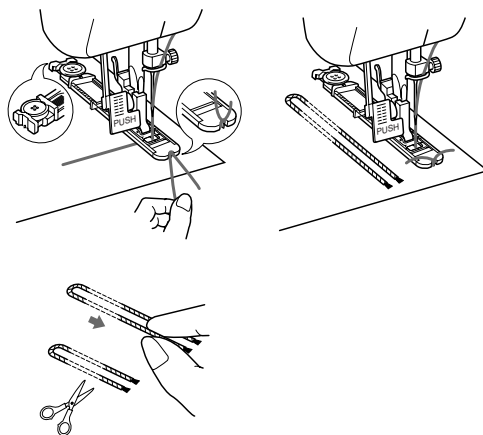

### Making a Buttonhole (4-Step Buttonhole)

Pattern	Stitch Length [mm (inch)]	Stitch Width [mm (inch)]	Foot
 (4-Step Buttonhole)	 -1.5 (1/64-1/16)	3-5 (1/8-3/16)	Buttonhole Foot



#### Memo

- We recommend that you practice making a buttonhole on a scrap piece of fabric before you try it on the actual garment.
- When making buttonholes on soft fabrics, place stabilizer material on the underside of the fabric.

Making a buttonhole is a simple process that provides reliable results.

#### ■ Making a Buttonhole

- 1** Using tailor's chalk, mark the position and length of the buttonhole on the fabric.
- 2** Attach the buttonhole foot, and then slide the outside frame of the buttonhole foot as far back as possible.



- 3** You need to sew the front bar tack first. Line the bar tack mark under the center of the presser foot and align it with the two lines on the presser foot.

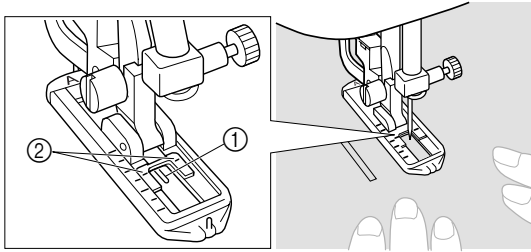

① Front of chalk mark  
② Red lines

**CAUTION**

- If the presser foot is not installed with the correct orientation, the needle may strike the presser foot, bending or breaking the needle and causing injuries.

■ Making A Buttonhole

Step	Sewn section	Pattern
Step 1 (Front bar tack)		
1. Set the pattern selection dial to "a". 2. Lower the presser foot and sew 5 to 6 stitches. 3. Stop the machine when the needle is at the left side of the stitches, and then raise the needle from the material.		
Step 2 (Left side)		
1. Turn the pattern selection dial to "b". 2. Sew the predetermined length of the tailor's chalk line. 3. Stop the machine when the needle is at the left side of the stitch, and then raise the needle.		
Step 3 (Back bar tack)		
1. Turn the pattern selection dial to "c" (same position as in step 1). 2. Sew 5 to 6 stitches. 3. Stop the machine when the needle is at the right side of the stitch, and then raise the needle from the material.		
Step 4 (Right side)		
1. Set the pattern selection dial to "d". 2. Sew the right side until the needle reaches the stitches sewn in step 1.		

■ Securing the Stitching and Cutting the Buttonhole

- 1 To secure the stitching, turn the material 90 degrees counterclockwise and sew straight stitches to the end of the front bar tack of the buttonhole.
- 2 Remove the material from the machine. We recommend that you put pins across both ends of the buttonhole to prevent the stitches from being cut.
- 3 Cut an opening in the middle of the buttonhole with a seam ripper. Be careful not to cut through any stitches.

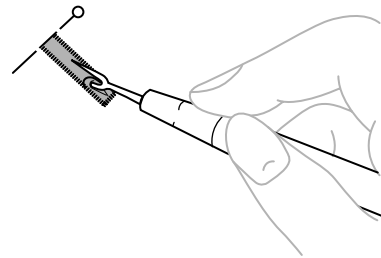

**CAUTION**

- When using the seam ripper to open the buttonhole, do not put your hand or fingers in the path of the ripper. The seam ripper may slip and cause injuries.

## Adjusting Buttonholes

If the stitching on the two sides of the buttonhole is not the same, you can make the following adjustments.

- 1 Set the stitch length dial to "1" and sew the buttonhole on a scrap piece of fabric to observe how the material is fed.
- 2 If the right side of the buttonhole is too coarse or fine, adjust the feeding of the material with the Stitch Length Dial.

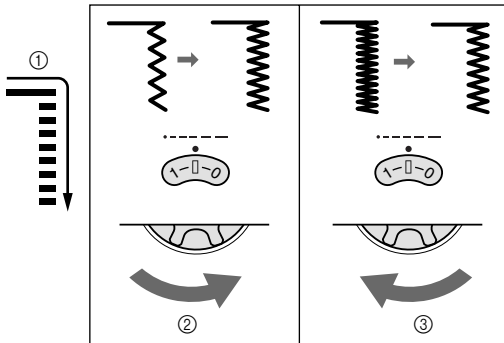

- 1 Right side
- 2 Shorter
- 3 Longer

- 3 After obtaining a satisfactory feeding on the right side, stitch the buttonhole and observe the feeding.
- 4 If the left side is too coarse or fine compared with the right side, adjust the buttonhole fine adjustment screw as described below.  
If the left side is too coarse, turn the buttonhole fine adjustment screw with a large screwdriver in the - direction.  
If the left side is too fine, turn the buttonhole fine adjustment screw with a large screwdriver in the + direction.

- This adjustment ensures both sides of the buttonhole are the same.

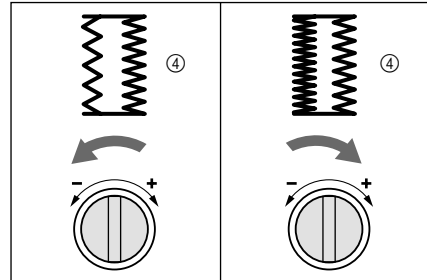
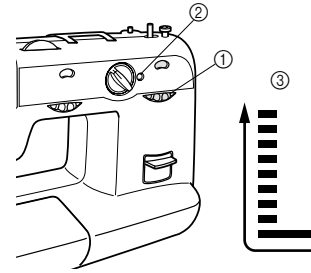

- 1 Stitch length dial
- 2 Buttonhole fine adjustment screw
- 3 Left side
- 4 In this case

## Sewing Buttons

Stitch Name	Pattern	Stitch Length [mm (inch)]	Stitch Width [mm (inch)]	Foot
Zigzag Stitch		1 (1/64)	Any	Button Sewing Foot

- 1 Measure the distance between the holes and set the appropriate stitch width using the stitch width dial. For example, if the distance between the holes is 1.5 mm (1/16"), set the stitch width to "1.5".
- 2 Attach the button sewing foot.
- 3 Place the darning plate on the needle plate. (On a machine equipped with a drop feed lever, lower the feed dogs by setting the drop feed lever to the up position.)

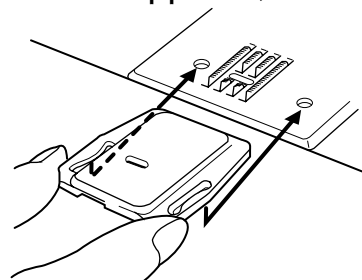

- 4** Put a button between the foot and the fabric and make sure that the needle enters the holes without hitting the button. If it hits, see step **1**.

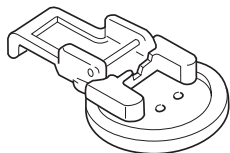

- 5** At a slow speed, sew about 10 stitches.

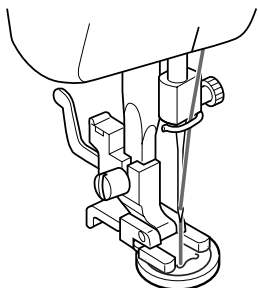

- 6** Remove the material from the machine. Cut the upper and lower threads and tie both threads at the back of the material.



**! CAUTION**

- Make sure the needle does not hit the button during sewing, otherwise the needle may break and you may be injured.

**Zipper Insertion**

Stitch Name	Pattern	Stitch Length [mm (inch)]	Stitch Width [mm (inch)]	Foot
Straight Stitch	---	2-3 (1/16-1/8)	2.5 (center needle position) (3/32)	Zipper Foot

You can use the zipper foot to sew different types of zippers, and can easily position the zipper to the right or left side of the needle. When sewing the right side of the zipper, attach the presser foot holder to the left pin of the zipper foot. When sewing the left side of the zipper, attach the presser foot holder to the right pin of the zipper foot.

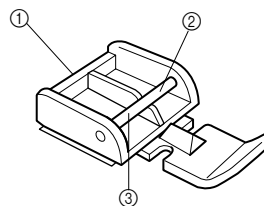

- ① Zipper foot
- ② Right pin for sewing the left side of the zipper
- ③ Left pin for sewing the right side of the zipper

- 1** Set the pattern selection dial to the Straight Stitch (center needle position (2.5 mm (3/32))).
- 2** Lower the presser foot lever and fix either the left or right pin of the zipper foot onto the shank.
- 3** Fold the edge of the material 2 cm (3/4") and place the zipper under the folded section.
- 4** Use the stitch width dial to adjust the needle position. Lower the needle into the notch on either the left or right side of the zipper foot.

**! CAUTION**

- Turn the balance wheel by hand to make sure the needle does not hit the presser foot before you start sewing. If you choose a different stitch, the needle will hit the presser foot and break the needle. You may also be injured.

- Sew from the bottom of the zipper toward the top on both sides. The needle should be positioned on the zipper side of the foot for best results.

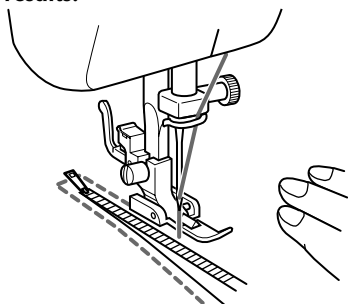

- To sew the opposite side of the zipper, release the foot by raising the lever located at the back of the presser foot, position the zipper foot on the other side of the zipper and continue sewing using the notch on the other side.

### ⚠ CAUTION

- Make sure the needle does not hit the zipper during sewing. If the needle hits the zipper, the needle may break and you may be injured.

## Gathering

Stitch Name	Pattern	Stitch Length [mm (inch)]
Straight Stitch	---	4 (3/16)

- Set the pattern selection dial to the Straight Stitch.
- Loosen the tension of the upper thread so that the lower thread lies on the underside of the material.
- Sew a single row (or many rows) of straight stitches.
- Pull the lower threads to gather the material.

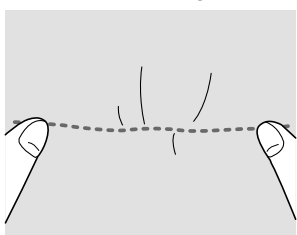

## Darning

Stitch Name	Pattern	Stitch Length [mm (inch)]
Straight Stitch	---	Any

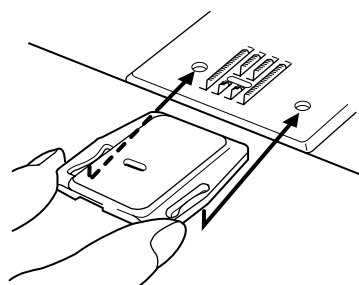

- Place the darning plate on the needle plate. (On a machine equipped with a drop feed lever, lower the feed dogs by setting the drop feed lever to the up position.)

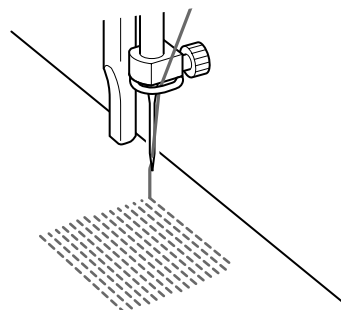

- Set the pattern selection dial to the Straight Stitch.
- Put the section you want to darn under the presser foot, together with a piece of fabric for reinforcement.
- Remove the presser foot and presser foot holder, and then lower the presser foot lifter.
- Begin sewing by alternating between gently drawing the work away from you and pulling it toward you.
- Repeat this motion until the darning section is filled with parallel lines of stitching.



## Appliqués

Stitch Name	Pattern	Stitch Length [mm (inch)]	Stitch Width [mm (inch)]
Zigzag Stitch		 -2 (1/64-1/16)	Any

You can create an applique by cutting a different piece of fabric into a shape and using it as a decoration.

- 1 Baste the cutout to the fabric at the desired location.
- 2 Carefully sew around the edge of the cutout using a Zigzag Stitch with a fine stitch length.

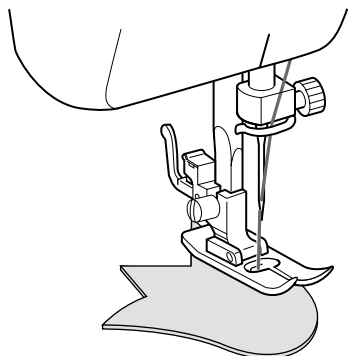

- 3 Cut away any fabric that is left outside the stitching.

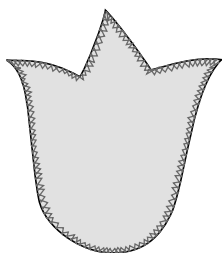

- 4 Remove the basting, if necessary.



### Memo

- Make reinforcing straight stitches at the beginning and the end of the stitching to secure it.

## ⚠ CAUTION

- Be careful that the needle does not hit a pin during sewing, as the needle can break. You may also be injured.

## Monogramming and Embroidering

Stitch Name	Pattern	Stitch Length [mm (inch)]	Stitch Width [mm (inch)]	Foot
Zigzag Stitch		Any	Any	None

### ■ Preparing for sewing a Monogram and Embroidering

- 1 Place the darning plate on the needle plate. (On a machine equipped with a drop feed lever, lower the feed dogs by setting the drop feed lever to the up position.)
- 2 Set the pattern selection dial to the Zigzag Stitch.
- 3 Draw the lettering (for monogramming) or design (for embroidering) on the surface of the fabric.
- 4 Stretch the fabric between embroidery hoops as firmly as possible, with the underside of the fabric on the bottom of the inside hoop.
- 5 Put the work under the needle with the presser foot holder assembly removed.
- 6 Pull the lower thread up through the work at the starting position by turning the balance wheel, and then make a few holding stitches.

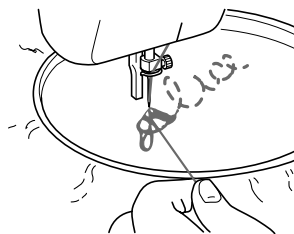

- 7 Grip the hoop with your thumbs and forefingers while pressing the fabric with your middle and third fingers and supporting the outside of the hoop with your little fingers.

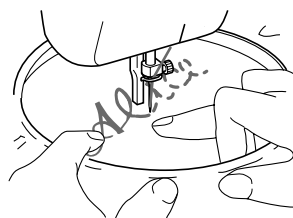



### Note

- After sewing without feeding, prepare for the next seam by returning the drop feed lever to the down position so that the feed dogs are raised.



### CAUTION

- Keep fingers away from moving parts, especially needles.

#### ■ Monogram

- 1 Sew by moving the hoop slowly along the lettering at a constant speed.
- 2 Secure with a few straight stitches at the end of the last letter.

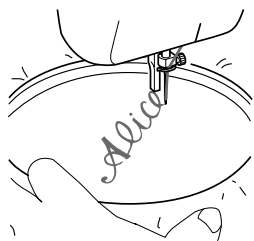

#### ■ Embroidering

- 1 Stitch the outline of the design by moving the embroidery hoop.

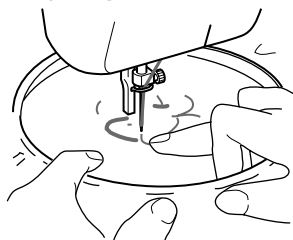

- 2 Fill in the design alternating from the outline of the design to the inside and from the inside to the edge of the outline until the design is completely filled in. Keep the stitching close together.

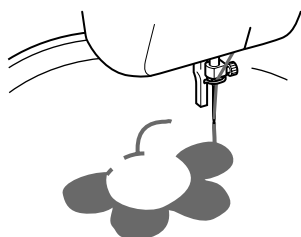

### Memo

- You can make long stitches by moving the embroidery hoop rapidly and short stitches by moving it slowly.



- 3 Secure with a few straight stitches at the end of the design.



### CAUTION

- Keep fingers away from moving parts, especially needles.

# MAINTENANCE

## Changing the Light Bulb

- 1 Remove the power supply plug from the outlet.

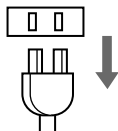

- 2 Loosen the face plate screw.

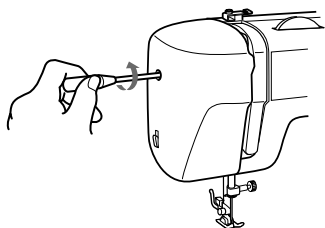

- 3 Remove the face plate from the machine as shown below.

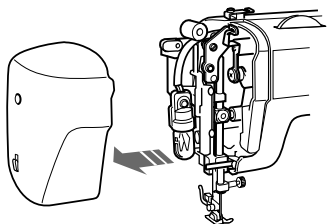

### Note

- Use only a bulb of the same type and rated 15 W.

- 4 Replace the sewing light bulb.

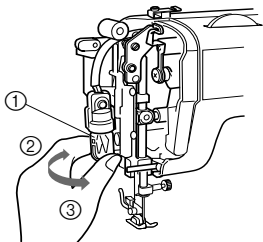

- ① Bulb
- ② Loosen
- ③ Tighten

- 5 Reattach the face plate and fasten the screw.

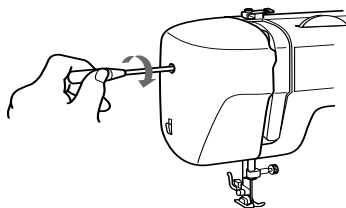

## Oiling

- 1 Remove the power supply plug from the outlet.

- 2 Remove the needle plate and the face plate, and then put 2 to 3 drops of oil at each point indicated by the arrows.

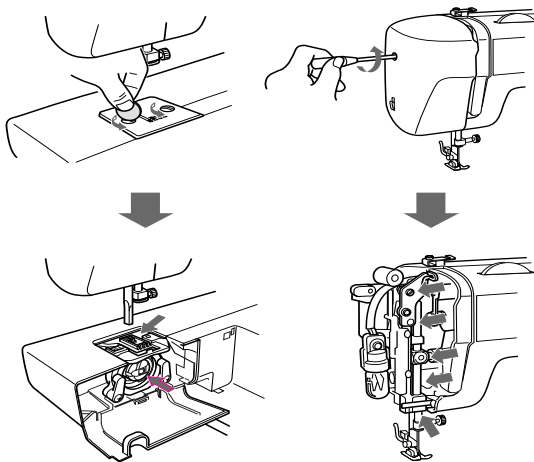

- 3 Operate the machine at a fast speed for a short time without thread installed.

- 4 Be sure to wipe any excess oil off the machine.

## Cleaning

### ■ Removing the Shuttle Hook

- 1 Raise the needle to its highest position and unplug the machine.
- 2 Remove the extension table and open the shuttle cover on the front of the free arm.
- 3 Take the bobbin case out of the shuttle race by opening and pulling the latch.
- 4 Slide the latch levers away from the retaining ring to remove it.

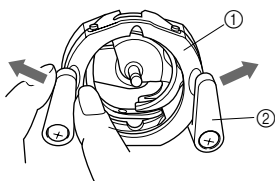

- ① Retaining ring
- ② Latch lever

- 5 Remove the hook by grasping its center post and pulling it out.

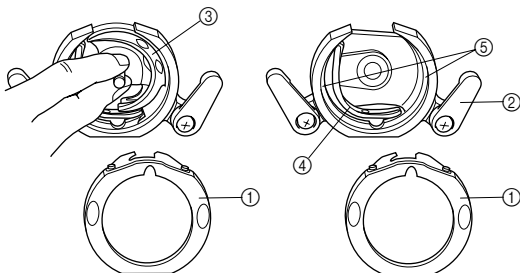

- ① Retaining ring
- ② Latch lever
- ③ Hook
- ④ Driver
- ⑤ Race body



### Note

- When the needle is lowered, the shuttle hook cannot be removed.

### ■ Cleaning the Shuttle Race

- 1 Remove any accumulated lint and thread from the retaining ring, hook, driver and race body with a brush.

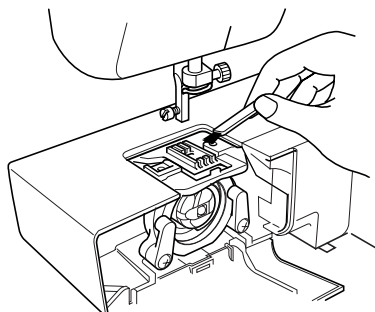

- 2 Wipe lint from the shuttle race using a cloth dampened with machine oil.
- 3 Clean the shuttle hook as described in step 2.
- 4 When reinstalling the removed parts, hold the retaining ring in place with the notch at the top while pushing the latch levers back to their original positions.

### ■ Cleaning the Feed Dogs

- 1 Remove the needle plate by removing the screws with a coin.
- 2 Clean the upper part of the feed dogs and shuttle race body with a brush.



## Performance Checklist

Whenever sewing difficulties are encountered, first review the manual section about the operation that you are performing, to make sure you are using the machine correctly. If the problem persists, the following checklist may help improve the operation.

If you still have difficulties, contact your nearest service center.

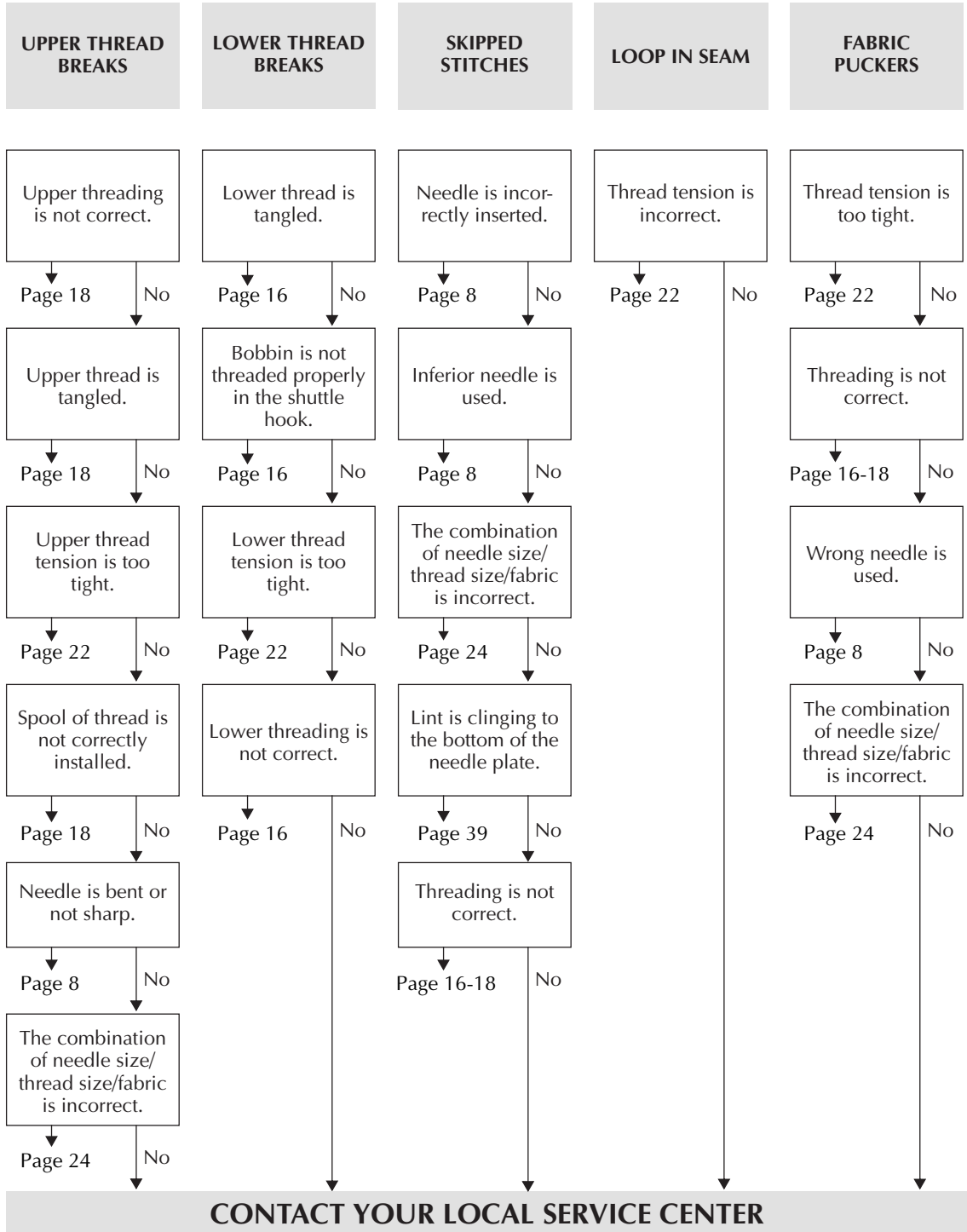

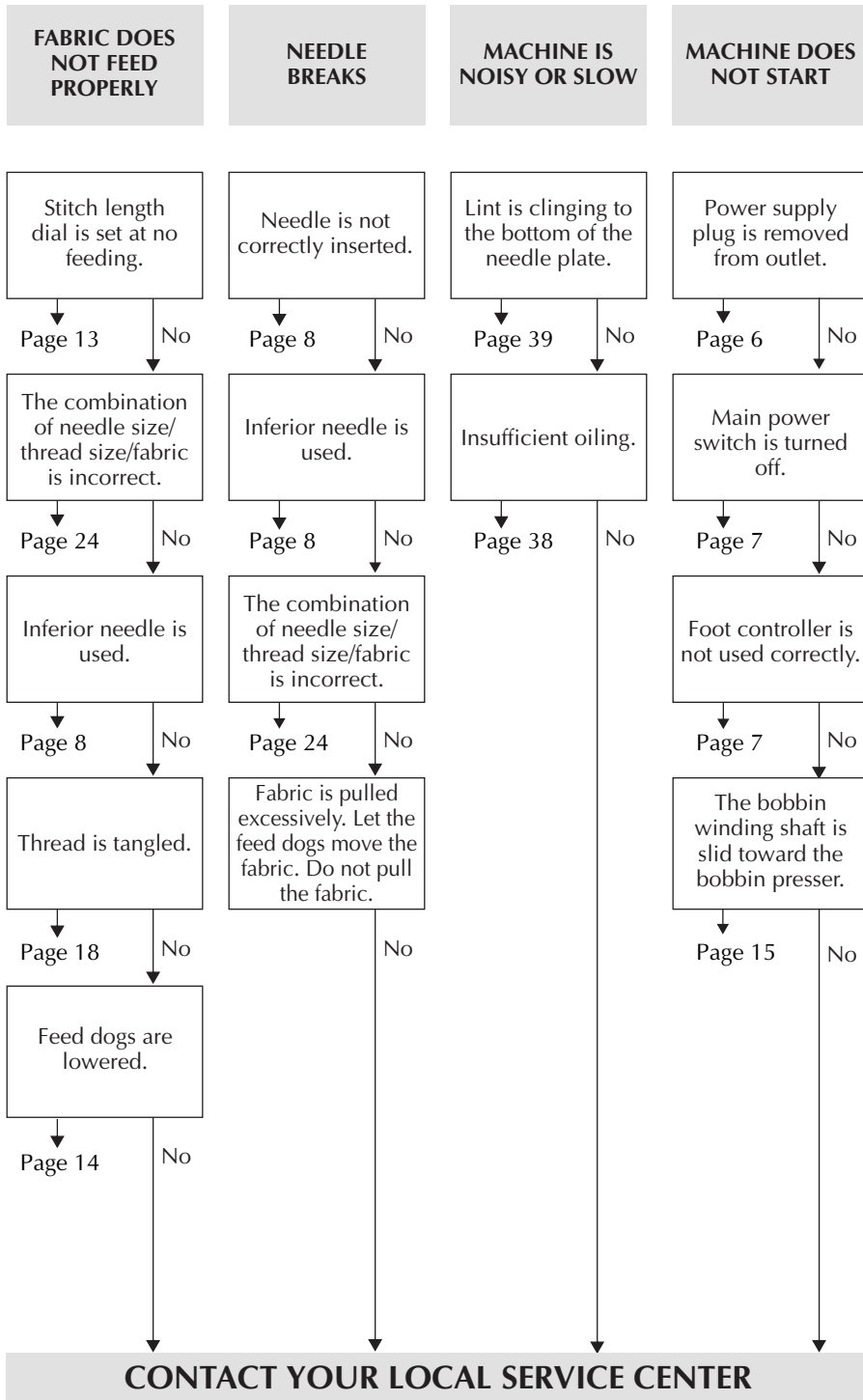

## Repacking the Machine

Keep the carton and packing materials for future use. You may have to take or send the machine to be repaired or wish to move the machine. If you do not pack it properly, or do not use the right packing material, the machine could be damaged.

Please follow the diagram below for repacking.

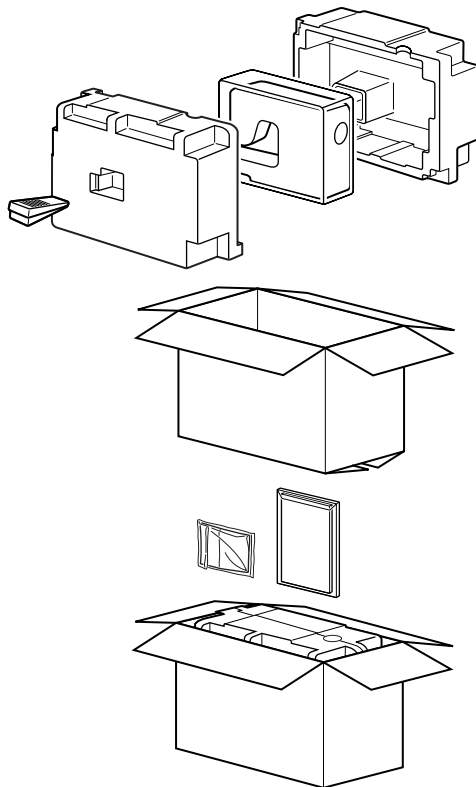

### IMPORTANT

- This packing material is designed to prevent damage. Save this packing material if you need to move the machine or take or send this machine to be repaired.

# INDEX

## Numerics

- 1-Step Automatic Buttonhole ..... 4, 5, 11, 12, 30
- 4-Step Buttonhole ..... 5, 12, 31

## A

- Accessories ..... 5
- Adjusting Buttonholes ..... 33
- Appliqués ..... 36
- Arrowhead Stitch ..... 11, 12, 13, 29

## B

- Blind Hem Stitch ..... 11, 12, 13, 27
- Bobbin Threading ..... 15, 20
- Bobbin Winder ..... 15
- Bridging Stitch ..... 11
- Buttonhole ..... 30, 31
- Buttonhole Fine Adjustment ..... 33
- Buttonhole Sewing ..... 30, 31

## C

- Changing Sewing Direction ..... 25
- Changing the Light Bulb ..... 38
- Changing the Presser Foot ..... 8
- Chart of Sewing Fabrics, Needles and Thread Combinations ..... 24
- Checking the Needle ..... 8
- Cleaning ..... 39
- Connecting Plugs ..... 6
- Converting to Free-arm Style ..... 9

## D

- Darning ..... 35
- Decorative Stitch ..... 11, 12, 30
- Double Action Stitch ..... 11, 12, 13, 29
- Drawing Up Lower Thread ..... 21
- Drawing Up the Lower Thread ..... 21
- Drop Feed Lever ..... 14

## E

- Elastic Overlock Stitch ..... 11, 12, 13, 29
- Elastic Stitch ..... 11, 12, 13, 28
- Embroidering ..... 36

## F

- Feather Stitch ..... 11, 12, 13, 29
- Feed Dogs Cleaning ..... 39
- Finishing Sewing ..... 26
- Foot Controller ..... 7
- Foot Controller Connecting ..... 6
- Foot Controller Operating ..... 7
- Free-arm Sewing ..... 9
- Free-arm Style ..... 9

## G

- Gathering ..... 35

## H

- Hole for Extra Spool Pin ..... 21

## I

- Inserting the Needle ..... 7

## L

- Leaf Stitch ..... 11, 12, 13
- Legs Stitch ..... 11
- Lower Threading ..... 16

## M

- Main Power and Sewing Light Switch ..... 2, 7
- Maintenance ..... 38
- Making a Buttonhole ..... 30, 31
- Monogramming and Embroidering ..... 36

## N

- Needle Replacement ..... 7
- Needle Threader ..... 19

## O

- Oiling ..... 38
- Overedge Stitching ..... 29

## P

- Pattern Length ..... 11
- Pattern Selection Dial ..... 10
- Pattern Width ..... 11
- Performance Checklist ..... 40
- Presser foot lever ..... 4
- Presser Foot Replacement ..... 8
- Principal Parts ..... 4

## Q

- Quick Thread-setting System ..... 20

## R

- Rampart Stitch ..... 11
- Recommended Widths and Lengths for Stitches ..... 11
- Repacking the Machine ..... 42
- Reverse Sewing Lever ..... 14

---

## S

---

Satin Stitch .....	26
Scallop Stitch .....	11, 12, 28
Sewing Buttons .....	33
Sewing Light Bulb Replacement .....	38
Sewing Light Switch .....	2, 7
Sewing with a Twin Needle .....	21
Shell Tuck Stitch .....	11, 12, 13, 27
Shuttle Hook Removal .....	39
Shuttle Race Cleaning .....	39
Spool pin .....	15, 18
Steadying the Machine .....	9
Stitch Length Dial .....	13
Stitch Width Dial .....	14
Straight Stitch .....	11, 12, 25, 34, 35
Stretch Blind Hem Stitch .....	11, 12, 27
Stretch Overlock Stitch .....	11, 12, 13, 29
Stretch Stitching .....	13

## T

---

Tension of the Thread .....	22
Thread Tension .....	22
Threading Bobbin .....	15
Threading Needle .....	19
Topstitching .....	26
Tree Stitch .....	11
Triple Stretch Stitch .....	11, 12, 13, 25
Triple Zigzag Stretch Stitch .....	11, 12, 13, 30
Twin Needle Sewing .....	21

## U

---

Upper Tention Control Dial .....	22
Upper Threading .....	18
Using the Needle Threader .....	19

## W

---

Winding the Bobbin .....	15
--------------------------	----

## Z

---

Zigzag Presser Foot .....	4, 5
Zigzag Stitch .....	11, 12, 26, 33, 36
Zipper Foot .....	5, 34
Zipper Insertion .....	34



## Free Manuals Download Website

<http://myh66.com>

<http://usermanuals.us>

<http://www.somanuals.com>

<http://www.4manuals.cc>

<http://www.manual-lib.com>

<http://www.404manual.com>

<http://www.luxmanual.com>

<http://aubethermostatmanual.com>

Golf course search by state

<http://golfingnear.com>

Email search by domain

<http://emailbydomain.com>

Auto manuals search

<http://auto.somanuals.com>

TV manuals search

<http://tv.somanuals.com>