



USER MANUAL

SP SMART SINE WAVE UPS

SP3000LCDRT2U | SP3000LCDRTXL2U
SP2200LCDRT2U | SP2200LCDRTXL2U
SP1500LCDRT2U | SP1500LCDRTXL2U
SP1000LCDRT2U | SP1000LCDRTXL2U

www.bxterra.com

WARRANTY & REGISTRATION.....	3
SAFETY INSTRUCTIONS.....	3-4
INSTALLATION & OPERATION.....	5-7
PRODUCT OVERVIEW.....	7-8
BATTERY REPLACEMENT.....	8-9
BATTERY KIT ASSEMBLY.....	9-10
BUTTON FUNCTIONS.....	10
LCD DISPLAY.....	11
AUDIBLE ALARMS.....	11
LCD DISPLAY WORD INDEX.....	11
UPS SETTINGS.....	12-14
FAULT CODES.....	15
WARNING INDICATORS.....	15
TROUBLESHOOTING.....	16
STORAGE AND MAINTENANCE.....	16
TECHNICAL SPECIFICATIONS.....	17-18
BATTERY PACK SPECIFICATIONS.....	18
WARRANTY INFORMATION.....	18

PRODUCT REGISTRATION

This bXterra product is constructed to provide unmatched power protection, quality and performance for the duration of its lifetime. Please take a few minutes to register your new product at www.bxterra.com/registration. Registration certifies your product's warranty, confirms your ownership in the event of a product loss or theft and entitles you to free technical support. Please register your product now to receive the benefits of bXterra ownership.

SAFETY

SAVE THESE INSTRUCTIONS: This manual contains important instructions that should be followed during installation and maintenance of the UPS and its batteries.

1. This unit is intended for installation in a controlled environment (a temperature-controlled and indoor area free of conductive contaminants). Please avoid installing the UPS in locations where there is standing or running water, dust, direct sunlight or excessive humidity.
2. Use caution when lifting the UPS. Because of the considerable weight of all rack-mount UPS systems, at least two people should assist in lifting and installing them.
3. Connect your UPS directly to a properly grounded AC power outlet with fuse or circuit breaker protection. Do not plug the unit into an outlet that is not grounded. Turn off and unplug the unit if you need to de-energize it.
4. For best performance, keep the indoor temperature around the unit between 32° F and 104° F (0° C and 40° C).
5. Do not attach medical equipment or non-computer related items, such as life-support equipment, microwave ovens or vacuum cleaners to the UPS. bXterra does not sell equipment meant for life-support or medical applications. Visit our website for more information about devices appropriate to plug into this UPS.
6. Only stand or set up the UPS in the direction specified in the Installation and Operation section of this manual. Do not block fans and leave adequate space around all sides of the UPS for proper ventilation. Do not expose the unit to direct sunlight and do not install the unit near heat-emitting appliances such as a space heater or furnace. This could negatively impact the unit's internal cooling system and cause product damage not covered under warranty.
7. As defined in the Protection of Information Technology Equipment ANSI/NFPA 75, this UPS is not for use in a computer room (US installations only). Contact bXterra to order a special battery kit if needed to meet the ANSI/NFPA 75 requirement.
8. When mounting the UPS system in a tower orientation, make sure the LCD screen panel is at the top of the UPS, not the bottom.
9. Do not plug the UPS input into its own output. Do not attach a power strip or surge protector to the UPS.
10. Do not modify the UPS's plug and do not use an adapter that would eliminate the UPS's ground connection.
11. Do not use extension cords to connect the UPS to an AC outlet.
12. The EPO and USB circuits are an IEC 60950-1 safety extra low voltage (SELV) circuit. This circuit must be separated from any hazardous voltage circuits by reinforced insulation.
13. If the UPS receives power from a motor-powered AC generator, the generator must provide clean, filtered, computer-grade output. Consult your generator's manual to see if it meets these specifications.
14. The main power outlet that supplies the UPS should be easily accessible and near the UPS.
15. To reduce the risk of fire or electric shock, do not use the unit on any transportation such as airplanes or ships. The effect of shock or vibration caused during transit and the damp environment can cause the unit to short out.
16. When installing the equipment, please ensure that the sum of the leakage current of the UPS and the connected devices does not exceed 3.5mA.
17. Do not disconnect the power cable on the UPS system or the building wiring outlet (grounded outlet) during operation since this would cancel the protective grounding of the UPS system and of all connected loads.

Battery Warnings:

- The UPS system operates with hazardous voltages. Repairs should only be performed by qualified maintenance personnel.
- Do not operate the UPS without batteries.
- Caution - risk of electric shock. Even after the unit is disconnected from the main power source, (building wiring outlet), components inside the UPS system are still connected to the battery and electrically live and dangerous.
- Before carrying out any kind of service and/or maintenance, disconnect the batteries and verify that no current is present and no hazardous voltage exists in the terminals of high-capability capacitors, such as BUS-capacitors.
- To avoid electrical shock, turn off the unit and unplug it from the AC power source before servicing the battery.
- Only persons who are adequately familiar with batteries and with the required precautionary measures may replace batteries and supervise operations. Unauthorized persons must be kept well away from the batteries.
- Do not dismantle the UPS during battery replacement.
- Caution - risk of electric shock. The battery circuit is not isolated from the input voltage. Hazardous voltages may occur between the battery terminals and the ground. Before touching, please verify that no voltage is present.
- When changing batteries, install the same number and same type of batteries.
- Do not attempt to dispose of batteries by burning them. This could cause an explosion.
- Do not open or destroy batteries. Escaping electrolytes can cause injury to the skin and eyes. It may be toxic.

A battery can may cause a risk of electrical shock and high short-circuit current. The following precautions should be observed when working on batteries:
 - a) Remove watches, rings, or other metal objects
 - b) Use tools with insulated handles
 - c) Wear rubber gloves and boots
 - d) Do not lay tools or metal parts on top of batteries
 - e) Disconnect charging source prior to connecting or disconnecting battery terminals
 - f) Determine if battery is inadvertently grounded. If inadvertently grounded, remove source from ground. Contact with any part of a grounded battery can result in electrical shock. The likelihood of such shock can be reduced if such grounds are removed during installation and maintenance.
- During hot-swap battery replacement, the UPS will not provide backup power in the event of a blackout or other power interruptions.

External Battery Connection Warnings:

When adding external battery packs to select models with external battery pack connectors, connect only bXterra battery packs of the correct voltage and type. Do not connect or disconnect battery packs when the UPS is operating on battery power. Visit www.bxterra.com to locate the supported battery type(s) for your UPS.

COMPATIBLE BATTERIES

MANUFACTURER	TYPE	RATING	CASE FLAMMABILITY
HITACHI Battery (MH14533)	GP 1272	12 V, 7.2 Ah	HB
	GP 1272 F2	12 V, 7.2 Ah	HB
	UPS 12360 6	12 V, 6.5 Ah	HB
	UPS 12360 7	12 V, 6.5 Ah	HB
	UPS 12460	12 V, 9 Ah	V-0
	UPS 12460 FR	12 V, 8.5 Ah	HB
	HR 1234W	12 V, 8.5 Ah	HB
	HR 1234W FR	12 V, 8.5 Ah	V-0
	UPS 12580	12 V, 9.4 Ah	HB
	UPS 12580 FR	12 V, 10 Ah	V-0
	TAIWAN YUASA (MH28947)	NPW36-12	12 V, 7.0 Ah
NPW36-12FR		12 V, 7.0 Ah	V-0
UXW360-12		12 V, 7.0 Ah	HB
UXW360-12FR		12 V, 7.0 Ah	V-0
UXW460-12		12 V, 8.0 Ah	HB
UXW460-12FR		12 V, 8.0 Ah	V-0
NPW45-12		12 V, 7.5 Ah	HB
NPW45-12FR		12 V, 7.5 Ah	V-0
SHIMASTU (MH28269)	NP7-12	12 V, 7.0 Ah	V-0
	NP9.0-12	12 V, 9.0 Ah	HB
FUJIAN MINHUA (MH47104)	MS7-12	12 V, 7.0 Ah	V-0
	MS9-12	12 V, 9.0 Ah	HB
SHENZHEN CENTER POWER (MH25860)	CP1270	12 V, 7.0 Ah	HB
	CP1290	12 V, 9.0 Ah	HB
SHENZHEN LEOCH BATTERIES (MH26866)	DJW12-7.0	12 V, 7.0 Ah	HB
	DJW12-7.0 FR	12 V, 7.0 Ah	V-0
	DJW12-9.0	12 V, 9.0 Ah	HB
	DJW12-9.0 FR	12 V, 9.0 Ah	V-0
	DJW12-10	12 V, 10 Ah	HB
	DJW12-10 FR	12 V, 10 Ah	V-0
SHENZHEN RITAR POWER (MH28539)	RT1270	12 V, 7.0 Ah	HB
	RT1290	12 V, 9.0 Ah	HB

INSTALLATION AND OPERATION

NOTE: Before installation, please inspect the unit. Be sure that nothing inside the package is damaged. Please keep the original package in a safe place for future use.

What's included in the box:

- 1. UPS System
- 2. User Manual
- 3. USB A+B Type Cable
- 4. Ear Racks x 2
- 5. Screws x 8
- 6. Tower Stands x 4
- 7. Phone Line Cable x 1
- 8. Serial Port Cable x 1

The UPS is shipped without the battery connected. Before installing the UPS, please follow the steps below to reconnect the battery wires.

STEP 1: Remove the front panel.

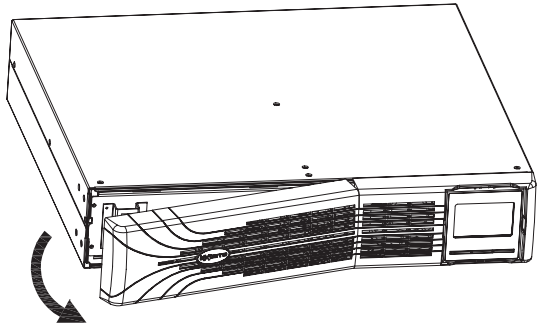

STEP 2: Connect the AC input and reconnect the battery wires.

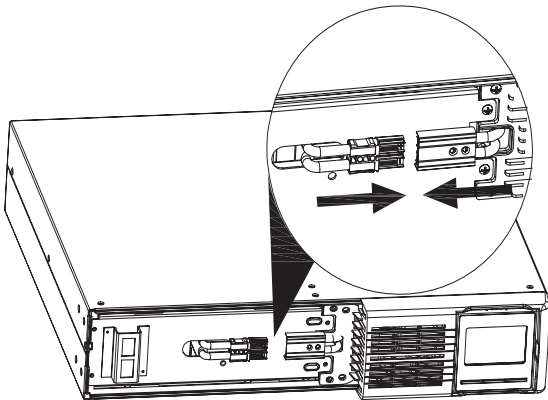

STEP 3: Put the front panel back on the unit.

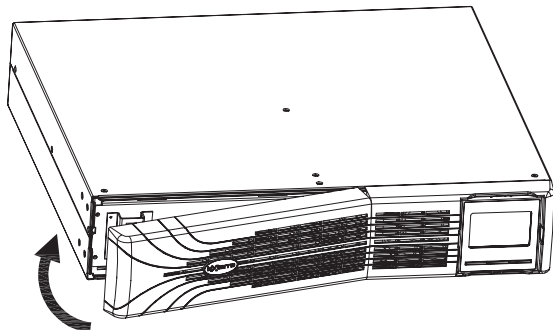

Rack-mount Installation

CAUTION - Do NOT use the mounting brackets to lift the unit. The mounting brackets are only for securing the unit to the rack.

Install UPS alone

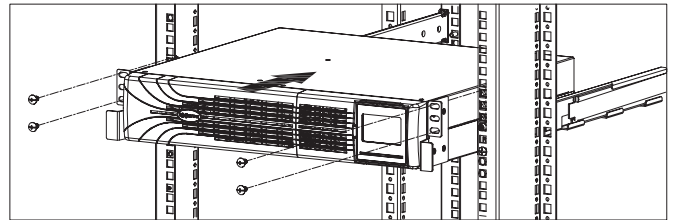
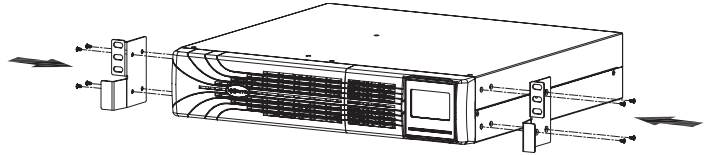

Install UPS and external battery

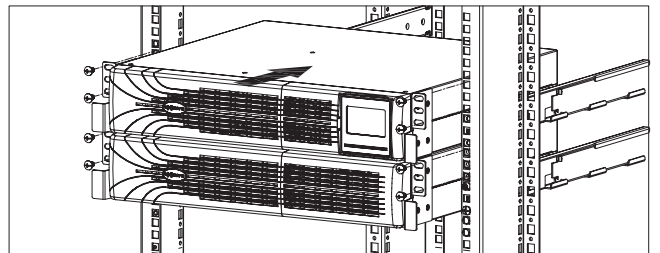
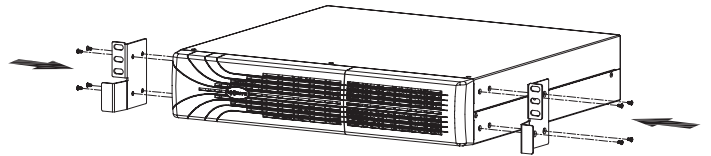

Tower Installation

STEP 1

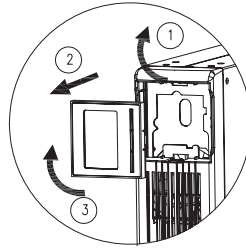
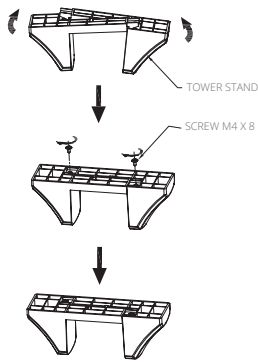

STEP 2

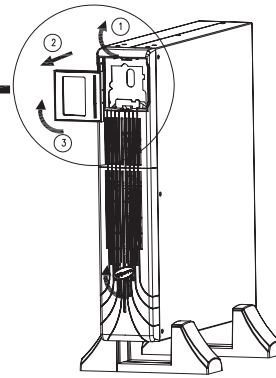

STEP 3

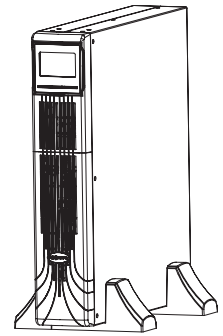

Install UPS and external battery in tower mode

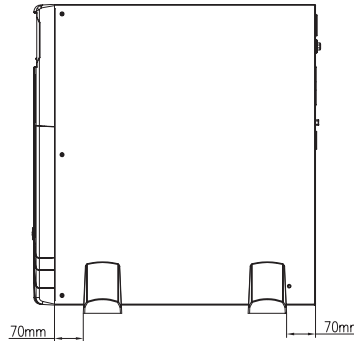
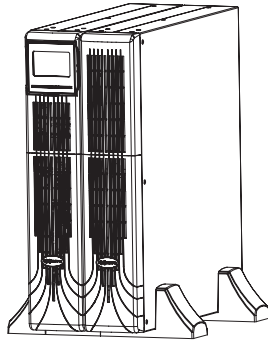
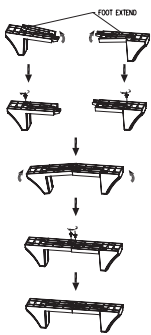

NOTE: When setting up the UPS and/or EBM with tower stands, please ensure the tower stands are installed a distance of 70mm away from the edge of the unit.

INSTALLATION AND OPERATION CONTINUED

Set Up The UPS

Step 1: UPS input connection

Plug the UPS into a 2-pole, 3-wire, grounded receptacle (wall outlet) only.

Step 2: UPS output connection

There are two types of outputs: Critical outlets and Noncritical outlets. Please connect noncritical loads to the Noncritical outlets and critical loads to the Critical outlets.

Step 3: Communication connection

Communication ports:

To allow for unattended UPS shutdown/start-up and status monitoring, connect one end of the communication cable to the USB/RS-232 port and the other end to the communication port of your PC. With the monitoring software installed,

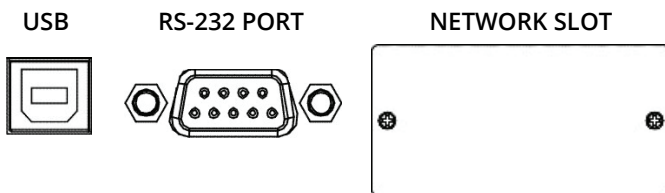

you can schedule UPS shutdown/start-up and monitor UPS status through the PC.

The UPS is equipped with a network slot for either the SNMP or AS400 card. After installing either the SNMP or AS400 card in the UPS, it will provide advanced communication and monitoring options.

Note: The USB port and RS-232 port can't work at the same time.

Step 4: Network connection

NETWORK/FAX/PHONE SURGE PORT

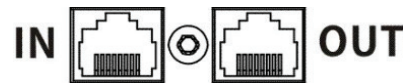

Connect a single modem/phone/fax line into the surge-protected "IN" outlet on the back panel of the UPS unit. Connect from "OUT" outlet to the equipment with another modem/fax/phone line cable.

Step 5: Disable and enable EPO function

This UPS is equipped with EPO (Emergency Power off) function. By default, the UPS is delivered from the factory with Pin 1 and Pin 2 closed (a metal plate is connected to Pin 1 and Pin 2) for UPS normal operation. To activate EPO function, remove two screws on the EPO port and the green connector will be removed. As a default, the EPO function is closed during normal UPS operation.

Note: The EPO function logic can be set up via an LCD setting. Please refer to Program 7 in the UPS setting for details.

To activate the EPO function, remove these two screws.

As a default, the EPO function is closed during normal UPS operation.

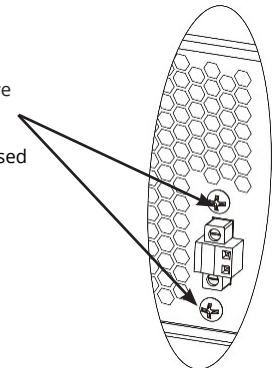

Step 6: Externed battery module connection

Connect one end of the external battery cable to the UPS unit and the other end to the battery module. See the chart below for detailed instructions.

CAUTION: Connection to an external battery should be installed by service personnel only.

NOTE: If connecting more than one Extended Battery Module, make sure to connect the load at 80% of the UPS's capacity.

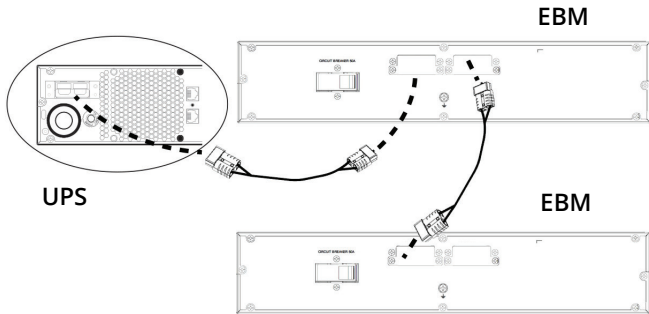

To connect an Extended Battery Module:

1. Turn off the UPS utility input.
2. Open the front-left cover on the UPS and the Extended Battery Module (EBM) and disconnect the internal batteries.
3. Remove the EBM-terminal covers from the UPS and the EBM and connect one end of the external-battery cable to the UPS and one end to the battery cabinet as shown in the figure above.
 - If connecting more than one external battery, connect one end of the external battery cable to the second connector on the battery module, then connect the other end to the next battery module as shown in the figure above.
4. Once the UPS and EBM(s) are connected, secure the connection with the screws, reconnect the internal batteries, and replace the front-left covers on the units.

NOTE: After install and initial start-up, set the number of installed battery modules in the UPS Settings.

NOTE: When 2 or more external battery modules are used with bXterra SP1000/2200/3000 series models, the UPS load rating is decreased by 20%.

Step 7: Turn on the UPS

Press the ON/Mute button on the front panel for two seconds to power on the UPS.

Note: The battery charges fully during the first five hours of normal operation. Do not expect full battery capability during this initial charge period.

Step 8: Install software

For optimal computer system protection, install UPS monitoring software to fully configure UPS shutdown and operation. Please follow steps below to download and install the monitoring software:

1. Go to the website <http://www.bxterra.com/downloads>
2. Click PowerFrame™ software icon and then choose your required OS to download the software
3. Follow the on-screen instructions to install the software
4. When your computer restarts, the monitoring software will appear as a Green "X" icon located in the system tray

AUTOMATIC VOLTAGE REGULATOR

The SP Smart Sine Wave UPS series adjusts inconsistent utility power to normal levels that are safe for your equipment. The AVR feature of this UPS can take erratic incoming utility power and correct it to safe levels. AVR automatically increases utility power that is too low or decreases utility power that is too high to a consistent 110 or 120 volts.

PRODUCT OVERVIEW

Introduction

Thank for choosing a bXterra Uninterruptible Power Supply. This UPS system is ENERGY STAR®-certified and uses our GreenTech™ Bypass Design to consume less power, reduce heat and improve UPS operation.

The SP Smart Sine Wave UPS series provides protection from utility power that may not always be safe for your devices. Each unit provides 1,372 Joules of surge suppression and supplies battery backup during power disruptions using maintenance-free batteries. Each SP Series model ensures consistent power to your connected equipment and critical devices. Each model also comes with access to PowerFrame™ Business Edition management software to remotely set up and manage your bXterra UPS.

SP1000LCDRT2U | SP1000LCDRTXL2U | SP1500LCDRT2U | SP1500LCDRTXL2U

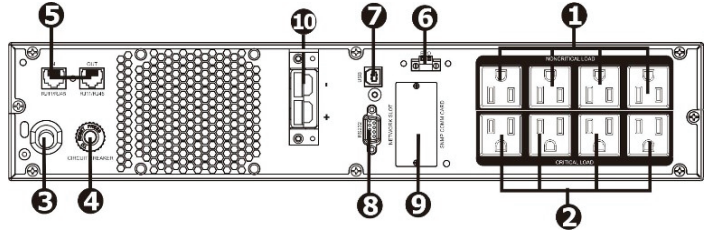

SP2200LCDRT2U | SP2200LCDRTXL2U

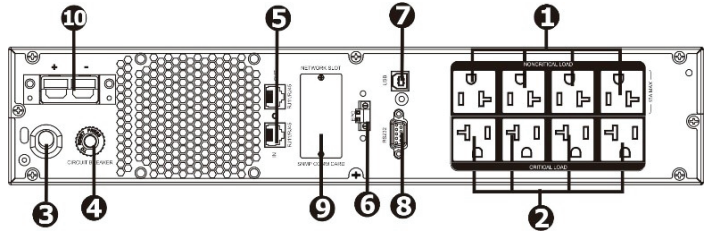

SP3000LCDRT2U | SP3000LCDRTXL2U

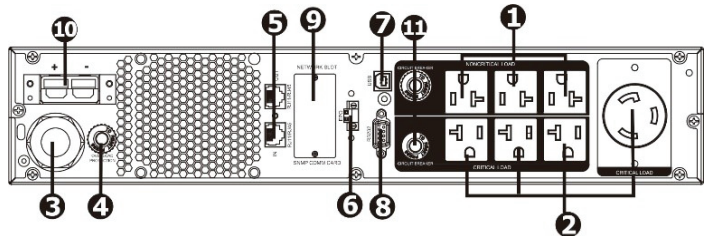

1. Noncritical outlets

Connect noncritical loads to these outlets. These outlets are programmable.

2. Critical outlets

Connect critical loads to these outlets. These outlets are not programmable.

3. AC input

Plug in the main power cord for the UPS here.

4. Input circuit breaker

This breaker provides overload and fault protection. If it trips, remove some of the load then reset it by pressing it in.

5. Network/Fax/Modem surge protection

These ports protect equipment from surges over a single phone line or network connection.

6. Emergency Power Off function connector (EPO)

This connector allows for the installation of an EPO function, a feature which allows for a rapid turn-off of the UPS in case of an emergency.

7. USB communication port

This port connects the UPS to any computer to download the UPS-monitoring software, PowerFrame™. Instructions for this can be found in the Installation section of this manual.

8. RS-232 communication port

This port allows for the connection of devices via the RS-232 protocol.

9. SNMP network slot

This port allows for installation of either the SNMP or AS400 card. These cards will provide advanced communication and monitoring options for the UPS.

10. External battery connector (only available for the XL model)

Allows for the connection of bXterra External Battery Modules to provide additional power and battery backup.

11. Output Circuit Breaker (only available on the SP3000 & SP3000XL models)

These resettable circuit breakers provide output outlets with protection from overload.

OPERATING PRINCIPLE

The operating principle of the UPS is shown below.

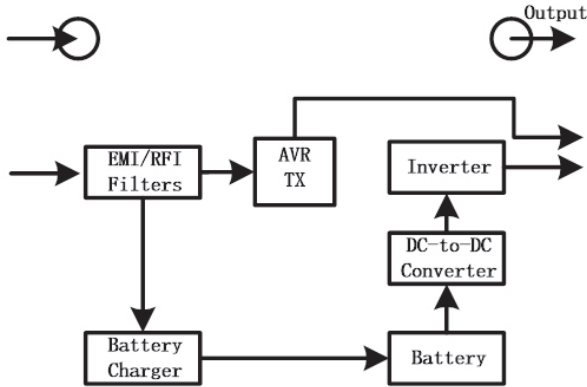

The UPS is composed of Power Input, EMI/RFI Filters, Inverter, Battery Charger, DC-to-DC Converter, Battery, AVR TX and UPS Output.

CERTIFICATIONS

NOTE: This equipment has been tested and found to comply with the limits for a Class B digital device, pursuant to Part 15 of the FCC Rules. These limits are designed to provide reasonable protection against harmful interference in a residential installation. This equipment generates uses and can radiate radio frequency energy and, if not installed and used in accordance with the instructions, may cause harmful interference to radio communications. However, there is no guarantee that interference will not occur in a particular installation. If this equipment does cause harmful interference to radio or television reception, which can be determined by turning the equipment off and on, the user is encouraged to try to correct the interference by one or more of the following measures:

- Reorient or relocate the receiving antenna
- Increase the separation between the equipment and receiver
- Connect the equipment into an outlet on a circuit different from that to which the receiver is connected
- Consult an experienced radio/TV technician for help



WARNING: Changes or modifications not expressly approved by the party responsible for compliance could void the user's authority to operate the equipment.

Our GreenTech™ UPS Bypass Design strives to deliver better operating performance while using less power required by other uninterruptible power supplies. The technology inside a bXterra UPS allows current to bypass the transformer and automatic voltage regulation (AVR) when utility power is running normally, reducing energy consumption. This can lead to substantial energy savings when utility power is running normally on a consistent basis.

At bXterra, we want you to know that you're not only protecting your devices and equipment when purchasing our products, but you're protecting the environment as well. Aside from being ENERGY STAR®-compliant, we are committed to and supporters of the Restriction of Hazardous Substances (RoHS) directive, which strictly limits the use of six hazardous substances (lead, mercury, cadmium, hexavalent chromium, polybrominated biphenyls (PBBs) and polybrominated diphenyl ether (PBDE)) in electrical equipment.



BATTERY REPLACEMENT ADVISORY

When the  icon and  are flashing on the LCD display and the alarm is sounding every two seconds, the batteries may need replacing. Contact your service representative to order new batteries.

NOTE: DO NOT DISCONNECT the batteries while the UPS is in Battery mode.

Batteries can be replaced easily without turning the UPS off or disconnecting the load. If you prefer to remove input power to change the batteries, press the OFF button on the front panel for two seconds to power off the UPS and switch the utility power off where the UPS is connected.

BATTERY REPLACEMENT

NOTE: A small amount of arcing may occur when connecting the internal batteries. This is normal and will not harm personnel. Connect the cables quickly and firmly.

STEP 1: Remove the front panel.

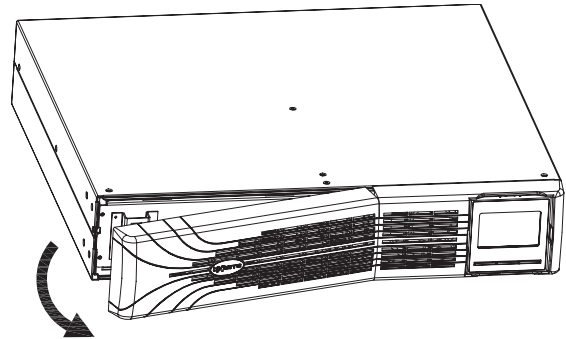

STEP 2: Disconnect battery wires.

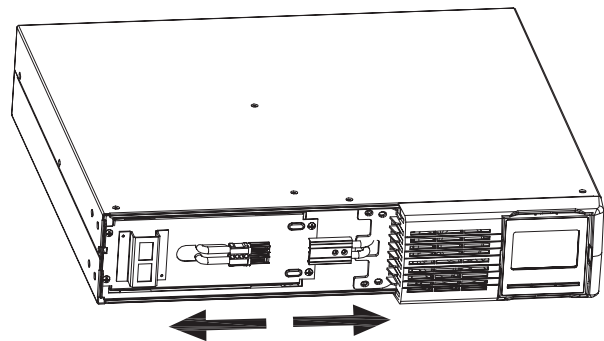

STEP 3: Pull out the battery box by removing two screws on the front panel.

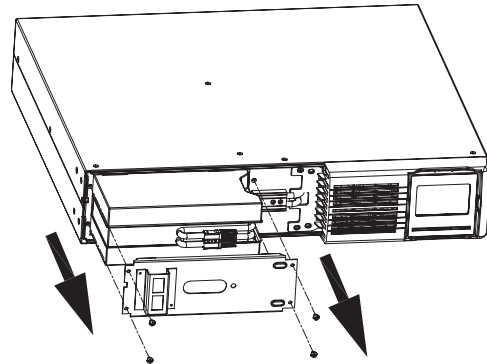

STEP 4: Remove the top cover of the battery box and replace the internal batteries.

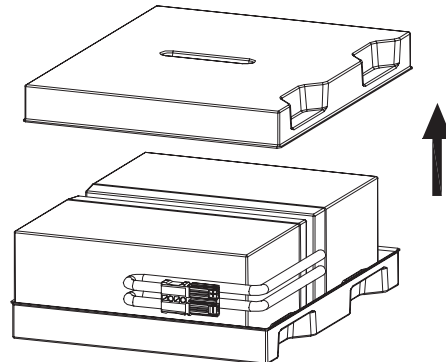

BATTERY REPLACEMENT CONTINUED

STEP 5: After replacing the batteries, put the battery box back to its original location and screw it in tightly.

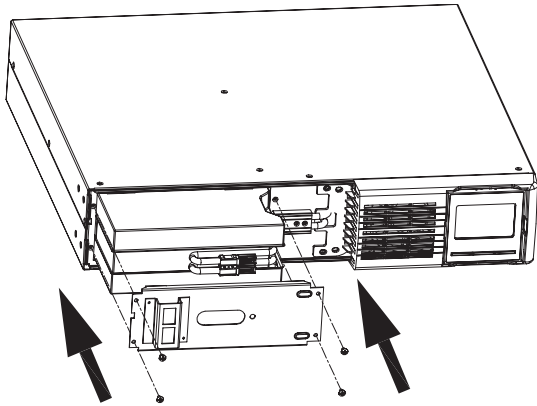

STEP 6: Reconnect the battery wires.

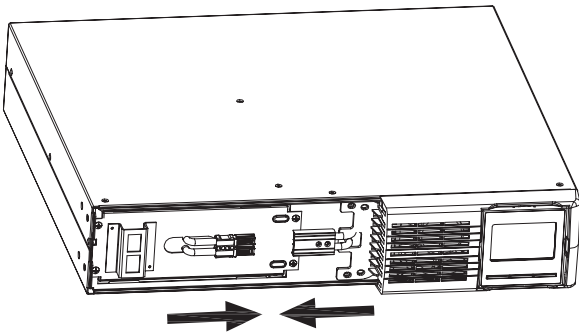

STEP 7: Put the front panel back on the unit.

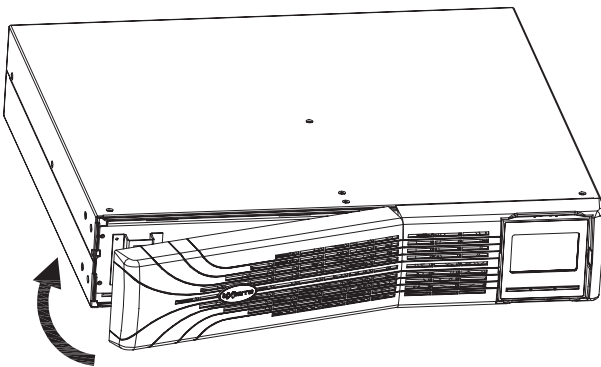

BATTERY KIT ASSEMBLY (OPTIONAL)

NOTE: Please assemble the battery kit first before installing it inside of the UPS. Please select the correct battery kit procedure below to assemble it.

2 BATTERY KIT

STEP 1: Remove the adhesive tape.

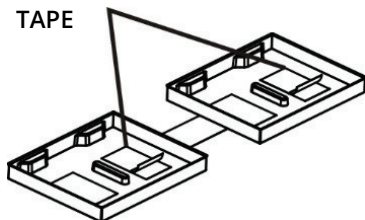

STEP 2: Connect all battery terminals by following the picture below.

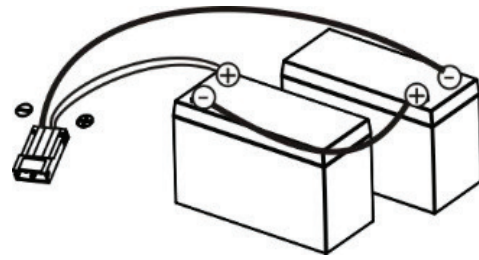

STEP 3: Put assembled battery packs on one side of the plastic shells as shown below.

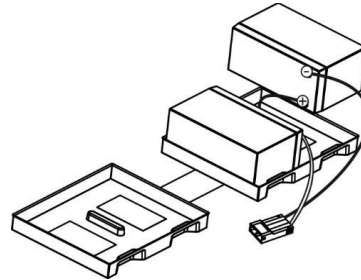

STEP 4: Cover the other side of the plastic shell as shown in the picture below. The battery kit assembly is now completed.

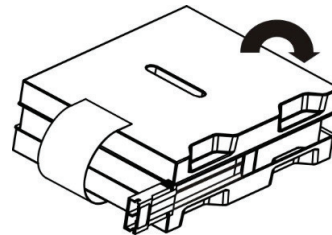

4 BATTERY KIT

STEP 1: Remove the adhesive tape.

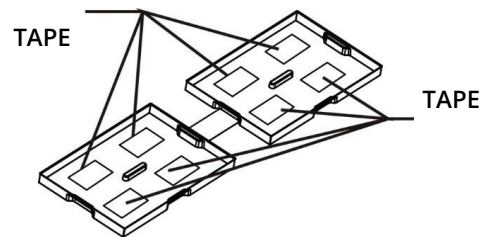

STEP 2: Connect all battery terminals by following the picture below.

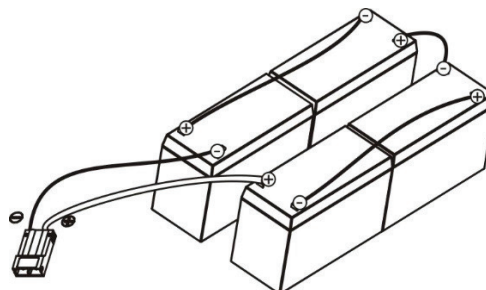

BATTERY KIT ASSEMBLY CONTINUED

STEP 3: Put assembled battery packs on one side of the plastic shells as shown below.

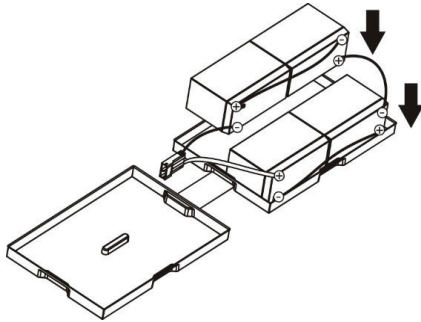

STEP 4: Cover the other side of the plastic shell as shown in the picture below. The battery kit assembly is now completed.

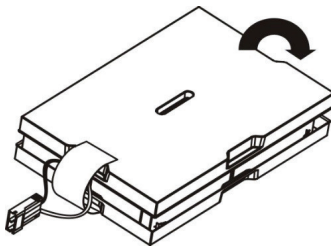

6 BATTERY KIT

STEP 1: Remove the adhesive tape.

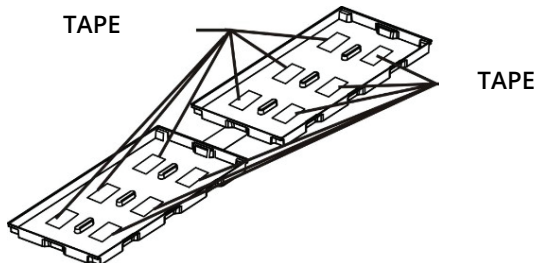

STEP 2: Put assembled battery packs on one side of the plastic shells as shown below.

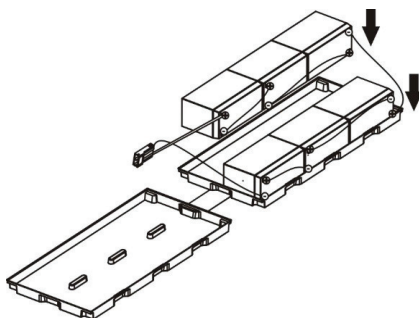

STEP 3: Connect all battery terminals by following the picture below.

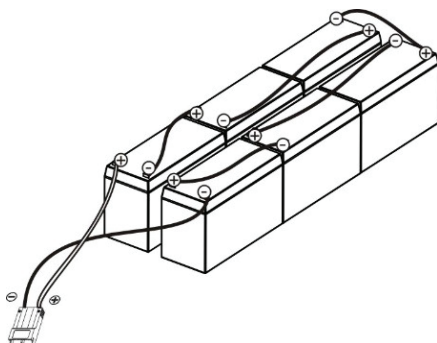

STEP 4: Cover the other side of the plastic shell as shown in the picture below. The battery kit assembly is now completed.

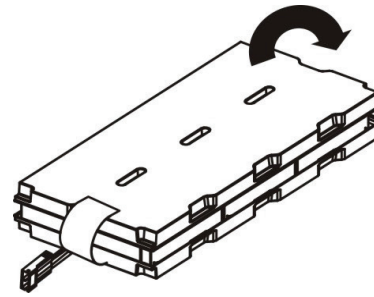

BUTTON FUNCTIONS

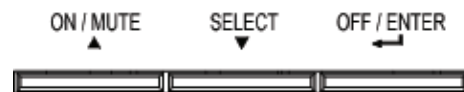

BUTTON	FUNCTION
ON/MUTE	<ul style="list-style-type: none"> Turn on the UPS: Press and hold ON/Mute button for at least two seconds to turn on the UPS. Mute the alarm: After the UPS is turned on in Battery Mode, press and hold this button for at least three seconds to disable or enable the alarm system. Note: This will not work when warnings or errors occur. Up key: Press this button to display the previous selection in UPS Setting Mode. Switch to UPS Self-Test Mode: Press and hold ON/ Mute button for three seconds to enter UPS self-testing while in AC Mode.
SELECT	<ul style="list-style-type: none"> Switch LCD message: Press this button to change the LCD message for input voltage, input frequency, battery voltage, output voltage and output frequency. Setting Mode: Press and hold this button for three seconds to enter UPS Setting Mode when the UPS is off. Down key: Press this button to display the next selection in UPS Setting Mode.
OFF/ENTER	<ul style="list-style-type: none"> Turn off the UPS: Press and hold this button at least three seconds to turn off the UPS. Confirm selection key: Press this button to confirm the selection in UPS Setting Mode.
ON/Mute + Select	<ul style="list-style-type: none"> Exit Setting Mode or return to the upper menu: When working in Setting Mode, press the ON/ Mute and Select buttons simultaneously to return to the main menu. If you are already at the main menu, press these two buttons at the same time to exit the Setting Mode.

LCD DISPLAY

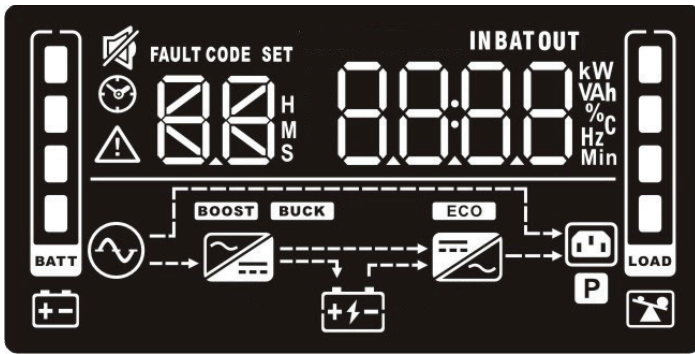

DISPLAY	FUNCTION
Backup time information	
00:00	Indicates the estimated backup time. H: hours, M: minute, S: second.
Configuration and fault information	
00	Indicates the configuration items. The configuration items are listed in detail in the UPS Settings section of the manual.
00	Indicates the warning and fault codes. The codes are listed in detail in the Fault Codes section of the manual.
Mute operation	
	Indicates that the UPS alarm is disabled.
Input, Battery, Output & Load information	
00.00 kWh VAh %C Hz	Indicates the input voltage, input frequency, battery voltage, battery capacity, output voltage, output frequency, load current and load percentage. k: kilo, W: watt, V: voltage, A: ampere, %: percent, Hz: frequency
Load information	
	Indicates the load level by 0-24%, 25-49%, 50-74% and 75-100%.
	Indicates overload.
Programmable/Noncritical outlets information	
	Indicates that programmable management outlets are working.
	Indicates the UPS is connected to main power.
	Indicates the battery is working.
	Indicates charging status.
	Indicates the ECO Mode is enabled.
	Indicates the UPS is working in Boost Mode.
	Indicates the UPS is working in Buck Mode.
	Indicates the AC to DC circuit is working.
	Indicates the inverter circuit is working.
	Indicates the output is working.

DISPLAY	FUNCTION
Battery information	
	Indicates the battery level by 0-24%, 25-49%, 50-74%, and 75-100%.
	Indicates low battery.

AUDIBLE ALARMS

Battery Mode	Beeping every 10 seconds
Low Battery	Beeping every two seconds
Overload	Beeping every second
Fault	Continuously beeping

LCD DISPLAY WORD INDEX

Abbreviation	Display Content	Meaning
ENA	ENA	Enable
DIS	di S	Disable
ESC	ESC	Escape
AO/AC	AO/AC	Active Open/Active Close
ST1/2/3	St 1/St2/St3	Input Waveform Sensitivity 1/2/3
AUT/AON	AUT/AON	Automatic/Always On
OK	OK	OK
ON	ON	ON
BL	BL	Battery Low
OL	OL	Overload
NC	NC	Battery Not Connected
OC	OC	Overcharge
SF	SF	Site Fault
EP	EP	EPO
TP	TP	Temperature
CH	CH	Charger
BF	BF	Battery Fault
BR	BR	Battery Replacement
EE	EE	EEPROM error

Parameter 1 **Parameter 2**

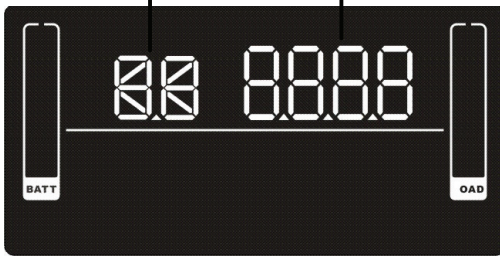

There are two parameters to set up the UPS.
Parameter 1 is used for program alternatives.
 Refer to the following LCD illustrations.
Parameter 2 is for setting options or values for each program.

01: OUTPUT VOLTAGE SETTING



SETTING
Parameter 2: Output voltage

For 120VAC models, you may choose the following output voltage:

- 100: presents output voltage is 100VAC
- 110: presents output voltage is 110VAC
- 115: presents output voltage is 115VAC
- 120: presents output voltage is 120VAC (Default)
- 125: presents output voltage is 125VAC

02: PROGRAMMABLE/NONCRITICAL OUTLETS ENABLE/DISABLE

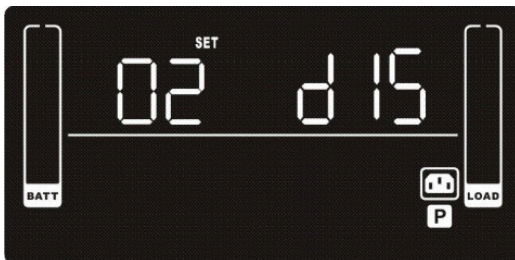

SETTING
Parameter 2: Enable or disable programmable outlets.

- ENA: Programmable outlets enabled
- DIS: Programmable outlets disabled (Default)

03: PROGRAMMABLE OUTLETS SETTING

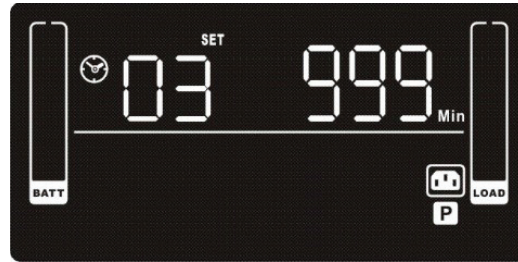

SETTING
Parameter 2: Set up backup time limits for programmable outlets.

0-999: setting the backup time limits in minutes from 0-999 for programmable outlets which connect to noncritical devices on Battery Mode. (Default: 999)

04: SITE FAULT DETECTION ENABLE/DISABLE

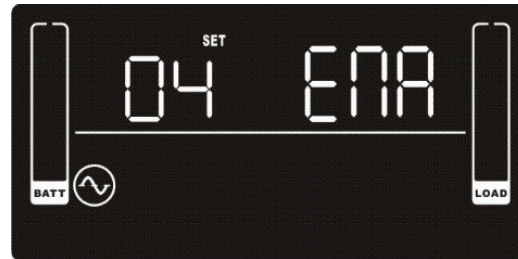

SETTING
Parameter 2: Enable or disable site fault detection. You may choose the following two options:

- ENA: Site fault detection enable (Default)
- DIS: Site fault detection disable

05: AUTONOMY LIMITATION SETTING

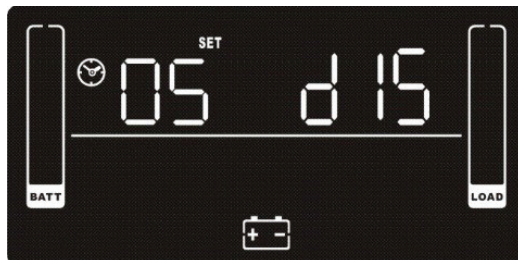

SETTING
Parameter 2: Set up backup time on Battery Mode for all outlets.

0-999: setting the backup time in minutes from 0-999 for all outlets on Battery Mode.
 DIS: By default, the autonomy limitation is disabled. Battery backup time will depend on battery capacity.
Note: When the setting is "0", the backup time will be only 10 seconds.

06: BATTERY TOTAL AH SETTING

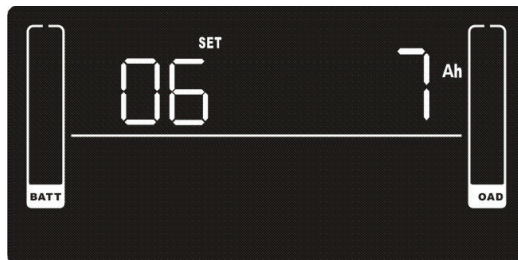

SETTING
Parameter 2: Set up the battery total AH of the UPS.

7-999: Setting the battery total capacity from 7-999 in AH. Please set the correct battery total capacity if Extended Battery Module is connected.

07: EPO LOGIC SETTING

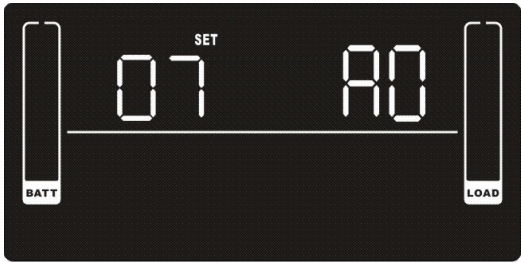

SETTING

Parameter 2: Set up the EPO function control logic.

AO: Active Open (Default). When AO is selected as EPO logic, it will activate EPO function with Pin 1 and Pin 2 in open status.

AC: Active Close. When AC is selected as EPO logic, it will activate EPO function with Pin 1 and Pin 2 in closed status.

08: INPUT WAVEFORM SENSITIVITY SETTING

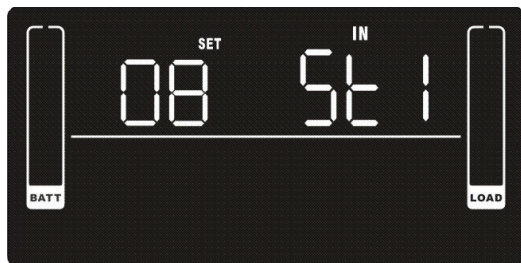

SETTING

Parameter 2: Set Input Waveform Sensitivity.

St1: Input voltage waveform detection sensitivity is high. (Default)

St2: Input voltage waveform detection sensitivity is average.

St3: Input voltage waveform detection sensitivity is low. (Use with generators or step wave input)

09: LCD DISPLAY BACKLIGHT SETTING

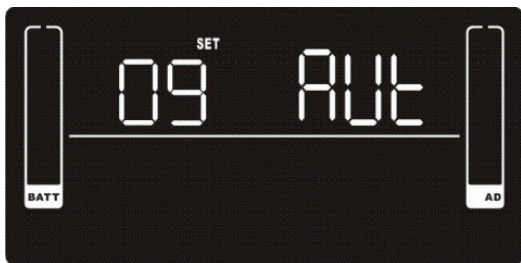

SETTING

Parameter 2: Set up the working conditions for the LCD display backlight.

Aon: LCD display backlight is on all the time.

Aut: LCD display backlight will turn off after 60 seconds of receiving no input. (Default)

00: EXIT SETTING



SETTING

Exit the Setting Mode.

STEPS FOR SETTING PROGRAMMABLE/NONCRITICAL OUTLETS

Step 1:

Before entering Setting Mode, the UPS should be in Standby Mode (off-charging) and make sure the battery is connected. The LCD display is shown below.

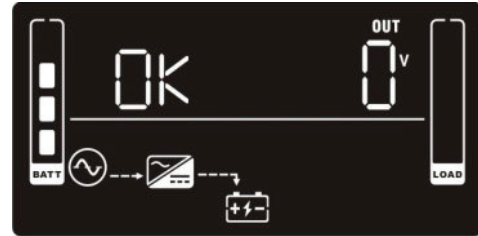

Step 2:

Press and hold the "Selection" button for three seconds to enter Setting Mode.



Step 3:

Press the "Up" button (ON/MUTE) to switch to "02" of program list. Then press "Enter" button to enter value setting of Parameter 2. Press the "Up" button to change the value to "ENA" to enable the programmable outlet function. Then press "Enter" button again to confirm the setting.



Step 4:

Press the "Up" button (ON/MUTE) again to switch to "03" of program list. Then press "Enter" button for setting programmable outlet time. Push "Up" button to change the value of backup time according to your demand. Then press "Enter" to confirm the setting.



Step 5:

Press "Up" button (ON/MUTE) to switch to "00" of program list. Then press "Enter" button to exit the setting menu.

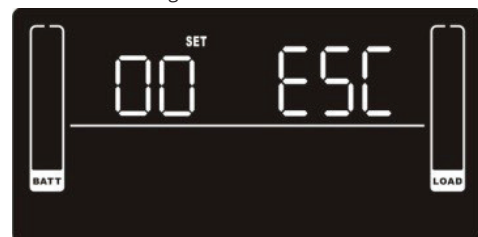





Step 6:

Disconnect AC input and wait until the LCD display is off. The new setting will be activated when turning on the UPS again.

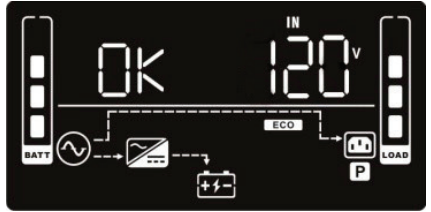
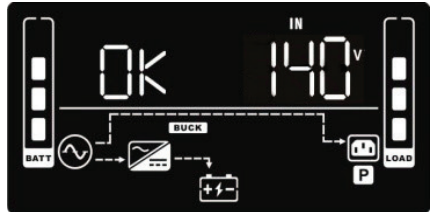
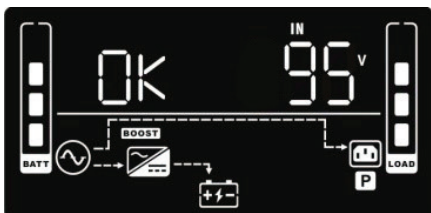
UPS SETTINGS CONTINUED

OPERATING MODE DESCRIPTION

















OPERATING MODE	DESCRIPTION	LCD DISPLAY
ECO mode	When the input voltage is within voltage regulated range, the UPS will power the output directly from the main power source. ECO is an abbreviation of Efficiency Corrective Optimizer. In this mode, when the battery is fully charged, the fan will stop working to save energy.	
Buck Mode when AC power is normal	When the input voltage is higher than the voltage regulation range but lower than the high-loss point, the buck AVR will be activated.	
Boost Mode when AC power is normal	When the input voltage is lower than the voltage regulation range but higher than the low-loss point, the boost AVR will be activated.	
Battery Mode	The UPS will supply backup power from the battery and display estimated remaining runtime, in minutes, when the input voltage is beyond the acceptable range or a power failure occurs.	
Standby Mode	The UPS is powered off and is not supplying output power, but is still charging its batteries.	
Fault Mode	When a fault occurs, the ERROR icon and the fault code will be displayed.	

FAULT CODES

FAULT EVENT	FAULT CODE	ICON
Bus start fail	01	X
Bus over	02	X
Bus under	03	X
Inverter soft start fail	11	X
Inverter voltage high	12	X
Inverter voltage low	13	X

FAULT EVENT	FAULT CODE	ICON
Inverter output short	14	X
Battery voltage too high	27	X
Battery voltage too low	28	X
Over temperature	41	X
Overload	43	
Charger failure	45	X









WARNING INDICATORS

WARNING	ICON (FLASHING)	CODE	ALARM
Low battery	 	bL	Beeping every two seconds
Overload	 	OL	Beeping every second
Battery is not connected	 	nC	Beeping every two seconds
Overcharge	 	OC	Beeping every two seconds
Site wiring fault	 	SF	Beeping every two seconds
EPO enable		EP	Beeping every two seconds
Over temperature		TP	Beeping every two seconds
Charger failure		CH	Beeping every two seconds
Battery fault		bF	Beeping every two seconds
Battery replacement		bR	Beeping every two seconds (At this time, the UPS is off to remind users something is wrong with the battery)
EEPROM error		EE	Beeping every two seconds

NOTE: "Site Wiring Fault" function can be enabled/disabled via our software. Please check the software manual for details.

TROUBLESHOOTING

If the UPS system does not operate correctly, please refer to the table below.

SYMPTOM	POSSIBLE CAUSE	REMEDY
The UPS is not functioning and shows no error indications even though the main power source is functioning normally	The AC input power connection is not connected properly	Check if the input power cord is firmly connected to the main power source
	The AC input is connected to the UPS output	Plug the AC input power cord to the AC input correctly
The  icon and the warning code EP are flashing on the LCD display and the alarm is beeping every two seconds	The EPO function is activated	Set the circuit in the closed position to disable the EPO function
The icon  ,  and the warning code SF are flashing on the LCD display and the alarm is beeping every two seconds	The line and neutral conductors of the UPS input are reversed	Rotate the main power socket by 180° and then connect it to the UPS system
The icon  ,  and the warning code BC are flashing on the LCD display and the alarm is beeping every two seconds	The external or internal battery is incorrectly connected	Check if the batteries are connected properly
The fault code is shown as 27 on the LCD display and the alarm is continuously beeping	The battery voltage is too high or the charger is faulty	Contact bXterra Technical Support
The fault code is shown as 28 on the LCD display and alarm is continuously beeping	The battery voltage is too low or the charger is faulty	Contact bXterra Technical Support
The icon  ,  and the warning code OL are flashing on LCD display and the alarm is beeping every second	The UPS is overloaded	Remove excess loads from the UPS output
The fault code is shown as 43 and the icon  is lit on the LCD display. The alarm is continuously beeping.	The UPS shut down automatically because of an overload at the UPS output	Remove excess loads from the UPS output and restart it
The fault code is shown as 14 and the alarm is continuously beeping	The UPS shut down automatically because a short circuit occurred on the UPS output	Check output wiring and if the connected devices are in short circuit status
The fault code is shown as 01, 02, 03, 11, 12, 13 and 41 on the LCD display and the alarm is continuously beeping	A UPS internal fault has occurred	Contact bXterra Technical Support
Battery backup time is shorter than expected	The batteries are not fully charged	Charge the batteries for at least five hours and then check capacity. If the problem persists, contact bXterra Technical Support.
	The batteries are defective	Contact bXterra Technical Support for replacement batteries
The fault code is shown as 45 on the LCD display. At the same time, the alarm is continuously beeping.	The charger does not have output and the battery voltage is less than 10V/PC	Contact bXterra Technical Support

STORAGE AND MAINTENANCE

The UPS system contains no user-serviceable parts. If the battery service life (3-5 years at 77°F ambient temperature) has been exceeded, the batteries must be replaced. In this case, please contact your dealer.

Before storing, charge the UPS at least five hours. Store the UPS covered and upright in a cool, dry location. During storage, recharge the battery in accordance with the following table:

STORAGE TEMPERATURE	RECHARGE FREQUENCY	CHARGING DURATION
-13°F - 104°F	Every three months	1-2 hours
104°F - 113°F	Every two months	1-2 hours

TECHNICAL SPECIFICATIONS

MODEL	SP1000LCDRT2U	SP1000LCDRTL2U	SP1500LCDRT2U	SP1500LCDRTL2U	SP2200LCDRT2U	SP2200LCDRTL2U	SP3000LCDRT2U	SP3000LCDRTL2U
Topology	Line Interactive							
INPUT								
Voltage	120 VAC							
Frequency Range	50/60Hz (auto-sensing)							
Input Voltage Range	81-152VAC							
Plug Type	NEMA 5-15P, 16 AWG	NEMA 5-15P, 14 AWG		NEMA 5-20P, 12 AWG		NEMA L5-30P, 10 AWG		
Plug Style	Straight Type							
Cord Length	10ft							
OUTPUT								
VA	1000VA	1500VA		1920VA		3000VA		
Watts	990W	1350W		1920W		2700W		
Automatic Voltage Regulation	Boost +15% / Buck -13%							
On Battery Voltage	120 VAC ± 1.5%							
On Battery Frequency	50/60 Hz ± 0.1 Hz							
On Battery Wave Form	Pure Sine Wave							
Outlet Type	NEMA 5-15R	NEMA 5-15R		NEMA 5-20R		NEMA 5-20/30R		
Outlet Total	8	8		8		7		
Battery and Surge Protected	8	8		8		7		
Outlets - Critical Load	4	4		4		4		
Load Management Receptacles	4	4		4		3		
Overload Protection	Firmware / Circuit Breaker							
Transfer Time	4ms Typical							
BATTERY								
Runtime at Half Load	10.2 minutes	12.5 minutes		12 minutes		12 minutes		
Runtime at Full Load	2.9 minutes	4.4 minutes		4 minutes		3.7 minutes		
Battery Type	Leakproof Sealed Lead-Acid							
Battery Size	12V/9AH	12V/7AH		12V/7AH		12V/9AH		
Battery Quantity	2	4		6		6		
User Replaceable	Yes							
DC System Voltage (VDC)	24VDC	48VDC		72VDC		72VDC		
Typical Recharge Time	4 hours							
Extended Runtimes Available	N/A	Yes	N/A	Yes	N/A	Yes	N/A	Yes
SURGE PROTECTION & FILTERING								
Surge Suppression	1372 Joules on UL report (Maximum)							
Phone Protection RJ11/ Ethernet RJ45	1-In, 1-Out							
EMI/RFI Filtration	Full time multi-pole noise filtering : 5% IEEE surge let-through : zero clamping response time : meets UL 1449							
MANAGEMENT & COMMUNICATIONS								
Multifunction LCD Panel	Displays: Load/Level, Runtime, Battery Level, Battery In Use, Input Voltage, Output Voltage, Output Frequency, Overload, Wiring Fault, Battery Voltage, Silent Mode, Normal Mode							
HID Compliant USB Port	Yes							
Serial Port	Yes							
EPO Port	Yes							
Management Cable	USB Cable, Serial Cable, EPO Cable(optional)							
Audible Alarms	Battery Mode, Low Battery, Overload, Fault							
Software	PowerFrame™ UPS Management Software							
SNMP / HTTP Remote Monitoring	Power management from SNMP Manager and web browser (optional)							

TECHNICAL SPECIFICATIONS CONTINUED

MODEL	SP1000LCDRT2U	SP1000LCDRTL2U	SP1500LCDRT2U	SP1500LCDRTL2U	SP2200LCDRT2U	SP2200LCDRTL2U	SP3000LCDRT2U	SP3000LCDRTL2U
PHYSICAL								
Form Factor	Rack/Tower							
Rack Size	2U							
Dimensions (in)	17.24 × 3.46 × 16.14		17.24 × 3.46 × 20.08		17.24 × 3.46 × 24.80		17.24 × 3.46 × 24.80	
Weight (lbs)	29.5		41.4		61.1		64.6	
ENVIRONMENTAL								
Operating Temperature	32°F to 104°F / 0°C to 40°C							
Storage Temperature	-13°F to 113°F / -25°C to 50°C							
Operating Humidity	0% - 95%RH@32-104°F (0-40°C) non-condensing							
Storage Relative Humidity	0 to 95%							
Maximum Operating Elevation	10,000 ft / 3,000 m							
Maximum Storage Elevation	50,000 ft / 15,000 m							
Audible Noise	<45dB							
AC Mode Thermal Dissipation	141 BTU/Hr		192 BTU/Hr		224 BTU/Hr		315 BTU/Hr	
CERTIFICATIONS								
Safety	cULus, FCC Part 15 Class B, ENERGY STAR® Qualified							
Environmental	RoHS Compliant							
WARRANTY								
Product Warranty	3 Year Limited							
Connected Equipment Guarantee	Yes							

Product specifications are subject to change without prior notice

EXTENDED BATTERY MODULE SPECIFICATIONS

MODEL	BP24V-SP2U	BP48V-SP2U	BP72V-SP2U
Used with UPS Models	SP1000LCDRTL2U	SP1500LCDRTL2U	SP2200LCDRTL2U/SP3000LCDRTL2U
Battery Type	12V/9Ah	12V/9Ah	12V/9Ah
DC System Voltage(VDC)	24VDC	48VDC	72VDC
Rack Size	2U	2U	2U
Battery Numbers	4	8	12
Dimensions (in)	17.24 × 3.46 × 16.14	17.24 × 3.46 × 20.08	17.24 × 3.46 × 24.8
Weight (lbs)	37.7	63.93	90.83

NOTE: To avoid potential problems with the UPS and/or EBM, please use the appropriate Extended Battery Module when connecting to the UPS.

WARRANTY INFORMATION

Your bXterra product comes with a Limited 3-Year Warranty. bXterra warrants this product, if used appropriately and in full accordance with all applicable instructions, to be free from original defects in material and workmanship for 3 years from the date of initial purchase. If the product can be proven defective in material or workmanship during that 3-year period, bXterra will, subject to the full terms and limitations of the product's Limited Warranty available on our website, repair or replace that product. bXterra will act on its own discretion as the sole remedy for bXterra's breach of its Limited Warranty. Full details of this Limited Warranty and bXterra's Connected Equipment Guarantee can be found on our website at www.bxterra.com/warranty or at the individual product's page on our website. Please register your product at www.bxterra.com/ registration to certify your product's warranty.

This manual is believed to be accurate, but bXterra reserves the right to change or correct the contents of this manual at a later date and does not assume any responsibility for omissions or errors.

All content is owned by Bxterra Power Technology. All Rights Reserved.
Reproduction is prohibited without permission. www.bxterra.com.

Free Manuals Download Website

<http://myh66.com>

<http://usermanuals.us>

<http://www.somanuals.com>

<http://www.4manuals.cc>

<http://www.manual-lib.com>

<http://www.404manual.com>

<http://www.luxmanual.com>

<http://aubethermostatmanual.com>

Golf course search by state

<http://golfingnear.com>

Email search by domain

<http://emailbydomain.com>

Auto manuals search

<http://auto.somanuals.com>

TV manuals search

<http://tv.somanuals.com>