

**imagePRESS C7010VPS
C6010VPS
C6010S
Safety Instructions**

Contents

Preface	3
1 How To Use This Manual	3
About This Manual	3
Symbols Used in This Manual	3
Abbreviations Used in These Manuals	4
Trademarks	5
2 Legal Notices	6
Product Name	6
Preventing Counterfeit Documents	6
FCC (Federal Communications Commission)	6
Laser Safety	7
IPv6 Ready Logo	7
Disclaimers	7
Legal Limitations on the Usage of Your Product and the Use of Images	8
3 Important Safety Instructions	9
Installation	9
Power Supply	10
Shutting Down the Machine in an Emergency	11
Handling	11
Maintenance and Inspections	13
Consumables	14
Other Warnings	14
Safety Labels	15
4 Installation Location and Handling	19
Installation Precautions	19
Avoid Installing the Machine in the Following Locations	19
Select a Safe Power Supply	22
Provide Adequate Installation Space	23
Moving the Machine	24
Handling Precautions	24
5 Periodic Inspection of the Breaker	27
Checking the Breaker	27
6 Check Sheet for the Periodic Inspection of the Breaker	29

Preface

Thank you for purchasing the Canon imagePRESS C7010VPS/C6010VPS/C6010S. Please read the safety instructions in this manual thoroughly before operating the machine. After reading this manual, store it in a safe place for future reference.





1 How To Use This Manual

About This Manual

This manual is targeted at general users of the machine. Dealers and operators trained to use the machine are not the target audience.

Symbols Used in This Manual

The following symbols are used in this manual to explain procedures, restrictions, handling precautions, and instructions that should be observed for safety.

-  **WARNING** Indicates a warning concerning operations that may lead to death or injury to persons if not performed correctly. To use the machine safely, always pay attention to these warnings.
-  **CAUTION** Indicates a caution concerning operations that may lead to injury to persons if not performed correctly. To use the machine safely, always pay attention to these cautions.
-  **IMPORTANT** Indicates operational requirements and restrictions. Be sure to read these items carefully to operate the machine correctly, and avoid damage to the machine or property.
-  **NOTE** Indicates a clarification of an operation, or contains additional explanations for a procedure. Reading these notes is highly recommended.
-  Indicates an operation that must not be performed. Read these items carefully, and make sure not to perform the described operations.

Abbreviations Used in These Manuals

In these manuals, product names and model names are abbreviated as follows:

Microsoft Windows 2000 Operating System:	Windows 2000
Microsoft Windows 2000 Professional Operating System:	Windows 2000 Professional
Microsoft Windows 2000 Server Operating System:	Windows 2000 Server
Microsoft Windows Server 2003 Operating System:	Windows Server 2003
Microsoft Windows XP Professional Operating System:	Windows XP Professional
Microsoft Windows XP Operating System:	Windows XP
Microsoft Windows Vista Operating System:	Windows Vista
Microsoft Windows Server 2008 Operating System:	Windows Server 2008
Microsoft Windows 7 Operating System:	Windows 7
Microsoft Windows Operating System:	Windows
Novell NetWare:	NetWare
Apple Macintosh:	Macintosh
Apple Mac:	Mac

Trademarks

MEAP and the MEAP logo are trademarks of Canon Inc.

Apple, AppleTalk, EtherTalk, LocalTalk, Macintosh, Mac, Mac OS, QuickTime, and Power Mac are trademarks of Apple Inc., registered in the U.S. and other countries.

Safari and Tiger are trademarks of Apple Inc.

Windows, the Windows logo, Windows Vista, and the Windows Vista logo are trademarks or registered trademarks of Microsoft Corporation in the U.S. and/or other countries.

2 Legal Notices

Product Name

Safety regulations require the product's name to be registered.

In some regions where this product is sold, the following name(s) in () may be registered instead.

- imagePRESS C7010VPS (F146000)
- imagePRESS C6010VPS (F146000)
- imagePRESS C6010S (F146000)

Preventing Counterfeit Documents

This machine includes a function for aiding in the prevention of counterfeit documents. If you are copying documents that resemble paper money closely, you may be unable to get an appropriate image.

FCC (Federal Communications Commission)

This equipment has been tested and found to comply with the limits for a Class A digital device, pursuant to Part 15 of the FCC Rules. These limits are designed to provide reasonable protection against harmful interference when the equipment is operated in a commercial environment. This equipment generates, uses, and can radiate, radio frequency energy and, if not installed and used in accordance with the Operator's Manual, may cause harmful interference to radio communications. Operation of this equipment in a residential area is likely to cause harmful interference in which case the user will be required to correct the interference at his own expense.

Use of shielded cables are required to comply with Class A limits in Subpart B of Part 15 of the FCC Rules.

Do not make any changes or modifications to the equipment unless otherwise specified in the manual. If you make such changes or modifications, you could be required to stop operation of the equipment.

If your equipment malfunctions, please contact your local authorized dealer from whom you purchased the equipment (if under warranty), or with whom you have a servicing contract. If you are not sure who to contact, and have both purchased and are using the equipment in the U.S.A., please refer to the "SUPPORT" page on Canon U.S.A.'s Web site (<http://www.usa.canon.com>).

Laser Safety

This product complies with 21 CFR Chapter 1 Subchapter J as a Class I laser product under the U.S. Department of Health and Human Services (DHHS) Radiation Performance Standard according to the Radiation Control for Health and Safety Act of 1968. Also, this product is certified as a Class I laser product under IEC60825-1: 2007. This means that the product does not produce hazardous laser radiation.

Since radiation emitted inside the product is completely confined within protective housings and external covers, the laser beam cannot escape from the machine during any phase of user operation. Do not remove protective housings or external covers, except as directed by the equipment's manual.

The labels shown below are attached to the top and front side of the marking engine.

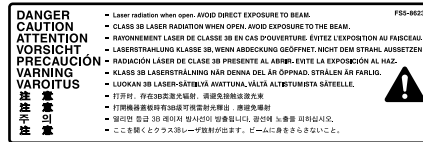

CAUTION

Use of controls, adjustments, or performance of procedures other than those specified in this manual may result in hazardous radiation exposure.

Disclaimers

The information in this document is subject to change without notice.

CANON INC. MAKES NO WARRANTY OF ANY KIND WITH REGARD TO THIS MATERIAL, EITHER EXPRESS OR IMPLIED, EXCEPT AS PROVIDED HEREIN, INCLUDING WITHOUT LIMITATION, THEREOF, WARRANTIES AS TO MARKETABILITY, MERCHANTABILITY, FITNESS FOR A PARTICULAR PURPOSE OF USE OR NON-INFRINGEMENT. CANON INC. SHALL NOT BE LIABLE FOR ANY DIRECT, INCIDENTAL, OR CONSEQUENTIAL DAMAGES OF ANY NATURE, OR LOSSES OR EXPENSES RESULTING FROM THE USE OF THIS MATERIAL.

 LAMP(S) INSIDE THIS PRODUCT CONTAIN MERCURY AND MUST BE RECYCLED OR DISPOSED OF ACCORDING TO LOCAL, STATE OR FEDERAL LAWS.

For CA, USA only

Included battery contains Perchlorate Material - special handling may apply.

See <http://www.dtsc.ca.gov/hazardouswaste/perchlorate/> for details.

Legal Limitations on the Usage of Your Product and the Use of Images

Using your product to scan, print or otherwise reproduce certain documents, and the use of such images as scanned, printed or otherwise reproduced by your product, may be prohibited by law and may result in criminal and/or civil liability. A non-exhaustive list of these documents is set forth below. This list is intended to be a guide only. If you are uncertain about the legality of using your product to scan, print or otherwise reproduce any particular document, and/or of the use of the images scanned, printed or otherwise reproduced, you should consult in advance with your legal advisor for guidance.

- Paper Money
- Money Orders
- Certificates of Deposit
- Postage Stamps (canceled or uncanceled)
- Identifying Badges or Insignias
- Selective Service or Draft Papers
- Checks or Drafts Issued by Governmental Agencies
- Motor Vehicle Licenses and Certificates of Title
- Travelers Checks
- Food Stamps
- Passports
- Immigration Papers
- Internal Revenue Stamps (canceled or uncanceled)
- Bonds or Other Certificates of Indebtedness
- Stock Certificates
- Copyrighted Works/Works of Art without Permission of Copyright Owner

■ To Avoid Unauthorized Use of the Machine

Unauthorized copies can be prevented by using the optional Key Switch Unit to manage the operation of the imagePRESS C7010VPS/C6010VPS/C6010S. The use of this key should be strictly supervised.

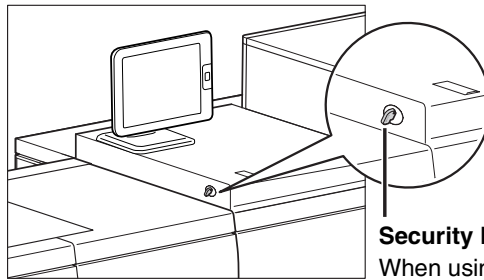

Security Key

When using the machine, insert the security key into the key switch unit, and then turn it to the right.

3 Important Safety Instructions

Please read these "Important Safety Instructions" thoroughly before operating the machine. As these instructions are intended to prevent injury to the user or other persons or destruction of property, always pay attention to these instructions. Also, since it may result in unexpected accidents or injuries, do not perform any operation unless otherwise specified in the manual. Improper operation or use of this machine could result in personal injury and/or damage requiring extensive repair that may not be covered under your Limited Warranty.

Installation

WARNING

- Do not install the machine near alcohol, paint thinner, or other flammable substances. If flammable substances come into contact with electrical parts inside the machine, it may result in a fire or electrical shock.
- Do not place the following items on the machine. If these items come into contact with a high-voltage area inside the machine, it may result in a fire or electrical shock. If these items are dropped or spilled inside the machine, immediately turn OFF the main power switch, and disconnect the power cord from the power outlet. Then, contact your local authorized dealer.
 - Necklaces and other metal objects
 - Cups, vases, flowerpots, and other containers filled with water or liquids

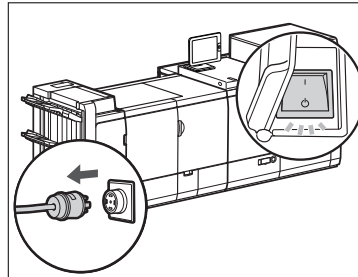

CAUTION

- Do not install the machine in unstable locations, such as unsteady platforms or inclined floors, or in locations subject to excessive vibrations, as this may cause the machine to fall or tip over, resulting in personal injury.
- Never block the ventilation slots and louvers on the machine. These openings are provided for proper ventilation of working parts inside the machine. Blocking these openings can cause the machine to overheat. Never place the machine on a soft surface, such as a sofa or rug.
- Do not install the machine in the following locations:
 - A damp or dusty location
 - A location near water faucets or water
 - A location exposed to direct sunlight
 - A location subject to high temperatures
 - A location near open flames

- Do not remove the machine's leveling feet after the machine has been installed, as this may cause the machine to fall or tip over, resulting in personal injury.

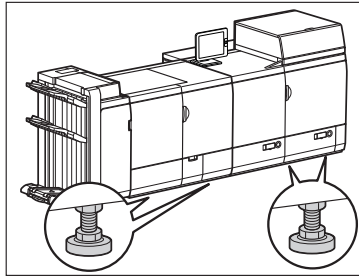

3 Power Supply

⚠ WARNING

- Do not damage or modify the power cord. Also, do not place heavy objects on the power cord, or pull on or excessively bend it, as this could cause electrical damage and result in a fire or electrical shock.
- Keep the power cord away from a heat source; failure to do this may cause the power cord coating to melt, resulting in a fire or electrical shock.
- Do not connect or disconnect the power cord with wet hands, as this may result in electrical shock.
- Do not connect the power cord to a multiplug power strip, as this may cause a fire or electrical shock.
- Do not bundle up or tie the power cord in a knot, as this may result in a fire or electrical shock.
- Insert the power plug completely into the power outlet, as failure to do so may result in a fire or electrical shock.
- Do not use power cords other than the power cord provided, as this may result in a fire or electrical shock.
- As a general rule, do not use extension cords. Using an extension cord may result in a fire or electrical shock. If an extension cord must be used, however, use one rated for voltages of 3-phase 5-wire, 208V AC 30 A and over (C7010VPS/C6010VPS/C6010S). Do not connect the power cord of the main unit and the power cord of any optional unit to the same extension cord. Untie the cord binding, and insert the power plug completely into the extension cord outlet to ensure a firm connection between the power cord and the extension cord.

⚠ CAUTION

- Do not use power supplies with voltages other than those specified herein, as this may result in a fire or electrical shock.
- Always grasp the power plug when disconnecting the power cord. Pulling on the power cord may expose or snap the core wire, or otherwise damage the power cord. If the power cord is damaged, this could cause current to leak, resulting in a fire or electrical shock.
- Leave sufficient space around the power plug so that it can be unplugged easily. If objects are placed around the power plug, you will be unable to unplug it in an emergency.
- Only connect the specified optional equipment to its power outlet. Connecting anything other than the specified optional equipment may lead to an accident such as a fire or smoke.

Shutting Down the Machine in an Emergency

This machine has a breaker that detects excess current or leakage current.

Make sure to turn the breaker dial to the OFF ("○" side) position, and then turn OFF the main power switch in an emergency.

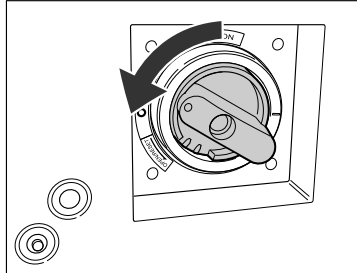

3

Handling

WARNING

- Do not attempt to disassemble or modify the machine. There are high-temperature and high-voltage components inside the machine which may result in a fire or electrical shock.
- If the machine makes strange noises, or gives off smoke, heat, or strange smells, immediately turn OFF the main power switch, and disconnect the power cord from the power outlet. Then, contact your local authorized dealer. Continued use of the machine in this condition may result in a fire or electrical shock.
- Do not use highly flammable sprays near the machine. If gas from these sprays comes into contact with the electrical components inside the machine, it may result in a fire or electrical shock.
- To avoid damage to the power cord and creating a fire hazard, always turn OFF the main power switch, and unplug the interface cable when moving the machine. Otherwise, the power cord or interface cable may be damaged, resulting in a fire or electrical shock.
- Do not drop paper clips, staples, or other metal objects inside the machine. Also, do not spill water, liquids, or flammable substances (alcohol, benzene, paint thinner, etc.) inside the machine. If these items come into contact with a high-voltage area inside the machine, it may result in a fire or electrical shock. If these items are dropped or spilled inside the machine, immediately turn OFF the main power switch, and disconnect the power cord from the power outlet. Then, contact your local authorized dealer.

⚠ CAUTION

- Do not place heavy objects on the machine, as they may tip over or fall resulting in personal injury.
- Close the optional feeder/platen cover gently to avoid catching your hands, as this may result in personal injury.

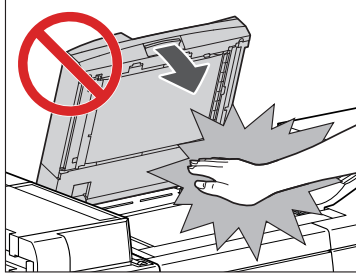

- Do not press down hard on the optional feeder/platen cover when using the platen glass to make copies of thick books. Doing so may damage the platen glass and result in personal injury.
- Do not touch the optional finisher while the machine is printing, as this may result in personal injury.
- For safety reasons, turn OFF the machine when it will not be used for a long period of time, such as overnight. Also, turn OFF the main power switch, and disconnect the power cord for safety when the machine will not be used for an extended period of time, such as during consecutive holidays.
- Do not place your hands, hair, clothing, etc., near the exit and feed rollers. Even if the machine is not in operation, your hands, hair, or clothing may get caught in the rollers, which may result in personal injury or damage if the machine suddenly starts printing.
- Do not place your hands in the part of the tray where stapling is performed (near the rollers) when an optional finisher is attached, as this may result in personal injury.

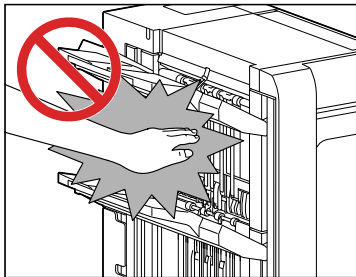

Finisher-AJ1/Saddle Finisher-AJ2

Maintenance and Inspections

WARNING

- When cleaning the machine, first turn OFF the main power switch, then disconnect the power cord. Failure to observe these steps may result in a fire or electrical shock.
- Disconnect the power cord from the power outlet regularly, and clean the area around the base of the power plug's metal pins and the power outlet with a dry cloth to ensure that all dust and grime is removed. If the power cord is connected for a long period of time in a damp, dusty, or smoky location, dust can build up around the power plug and become damp. This may cause a short circuit and result in a fire.
- Clean the machine using a slightly dampened cloth with a mild detergent mixed with water. Do not use alcohol, benzene, paint thinner, or other flammable substances. Check detergent for flammability prior to use. If flammable substances come into contact with a high-voltage area inside the machine, it may result in a fire or electrical shock.
- There are some areas inside the machine which are subject to high-voltages. When removing jammed paper or when inspecting the inside of the machine, do not allow necklaces, bracelets, or other metal objects to touch the inside of the machine, as this may result in burns or electrical shock.
- Do not burn or throw used toner cartridges into open flames, as this may cause the toner remaining inside the cartridges to ignite, resulting in burns or a fire.

CAUTION

- The fixing unit and its surroundings inside the machine may become hot during use. When removing jammed paper or when inspecting the inside of the machine, do not touch the fixing unit and its surroundings, as doing so may result in burns.

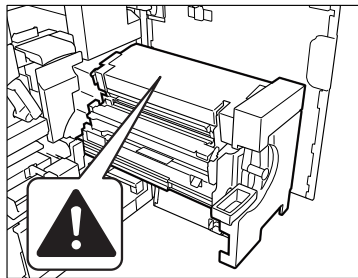

Primary Fixing Assembly

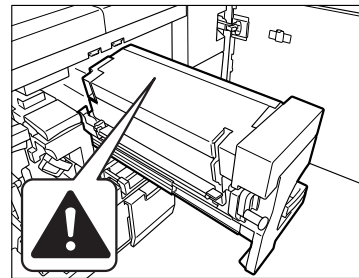

Secondary Fixing Assembly

- When removing jammed paper or replacing the toner cartridge, take care not to allow the toner to come into contact with your hands or clothing, as this will dirty your hands or clothing. If they become dirty, wash them immediately with cold water. Washing them with warm water will set the toner, and make it impossible to remove the toner stains.
- When removing paper which has become jammed inside the machine, remove the jammed paper gently to prevent the toner on the paper from scattering and getting into your eyes or mouth. If the toner gets into your eyes or mouth, wash them immediately with cold water and immediately consult a physician.
- When loading paper or removing jammed originals or paper, take care not to cut your hands on the edges of the originals or paper.
- When removing a used toner cartridge, remove the cartridge carefully to prevent the toner from scattering and getting into your eyes or mouth. If the toner gets into your eyes or mouth, wash them immediately with cold water and immediately consult a physician.
- Do not dismantle the toner cartridge, as dismantling it may cause toner dust to scatter on your skin or clothes. Immediately brush the toner off your clothes (but do not wash the clothing with hot water, which may cause the toner to set in the fabric). If toner gets into your eyes or mouth, wash them immediately with cold water and seek immediate medical treatment.

- Handle the toner cartridge carefully. Avoid contact with any toner that is released from the cartridge. If toner makes contact with your skin, immediately wash the area with soap and cold water. If your skin still feels irritated after washing the area thoroughly, or you ingest toner, seek immediate medical treatment.

Consumables

WARNING

- Do not burn or throw used toner cartridges into open flames, as this may cause the toner remaining inside the cartridges to ignite, resulting in burns or a fire.
- Do not store toner cartridges or copy paper in places exposed to open flames, as this may cause the toner or paper to ignite, resulting in burns or a fire.
- When discarding used toner cartridges, put the cartridges into a bag to prevent the toner remaining inside the cartridges from scattering, and dispose of them in a location away from open flames.

CAUTION

- Keep toner and other consumables out of the reach of small children. If these items are ingested, consult a physician immediately.
- Do not dismantle the toner cartridge, as dismantling it may cause toner dust to scatter on your skin or clothes. Immediately brush the toner off your clothes (but do not wash the clothing with hot water, which may cause the toner to set in the fabric). If toner gets into your eyes or mouth, wash them immediately with cold water and seek immediate medical treatment.
- Handle the toner cartridge carefully. Avoid contact with any toner that is released from the cartridge. If toner makes contact with your skin, immediately wash the area with soap and cold water. If your skin still feels irritated after washing the area thoroughly, or you ingest toner, seek immediate medical treatment.
- Use only toner cartridges intended for use with this machine.
- Do not replace toner cartridges until the message prompting you to do so appears.
- Handle the following substances correctly according to the Material Safety Data Sheet (MSDS). For more information on the latest MSDS, contact your local authorized dealer.
 - Toner - BARRIERTA
 - Super Lube Grease - Permalub G-2
 - Silicon Oil (S-20) - Alcohol (propanol (IPA))
 - Silicon Oil (S-400) - Alcohol (ethanol)

Other Warnings

WARNING

For cardiac pacemaker users:

This product emits low level magnetic flux. If you use a cardiac pacemaker and feel abnormalities, please move away from the product and consult your doctor.

Safety Labels

⚠ CAUTION

- The laser beam can be harmful to human bodies. Since radiation emitted inside the product is completely confined within protective housings and external covers, the laser beam cannot escape from the machine during any phase of user operation. Read the following remarks and instructions for safety.
- Never open covers other than those instructed in the User manual - Operating Information or the operator panel.
- If the laser beam escapes from the machine, exposure may cause serious damage to your eyes.
- There are some areas inside the machine, such as the fixing unit or the original output area, that are subject to high temperatures. Be careful to only touch those areas inside the machine as instructed in the manual. Failure to observe this precaution may result in burns.
- There are some areas inside the machine that are subject to high-voltages. These areas are indicated by caution labels. Be careful not to touch these areas or their surrounding areas when removing jammed paper, as this may result in an electrical shock.
- Do not remove the following caution labels which are attached to the machine. If the labels have been removed, contact your local authorized dealer.

■ Top (Front Side) of the Marking Engine

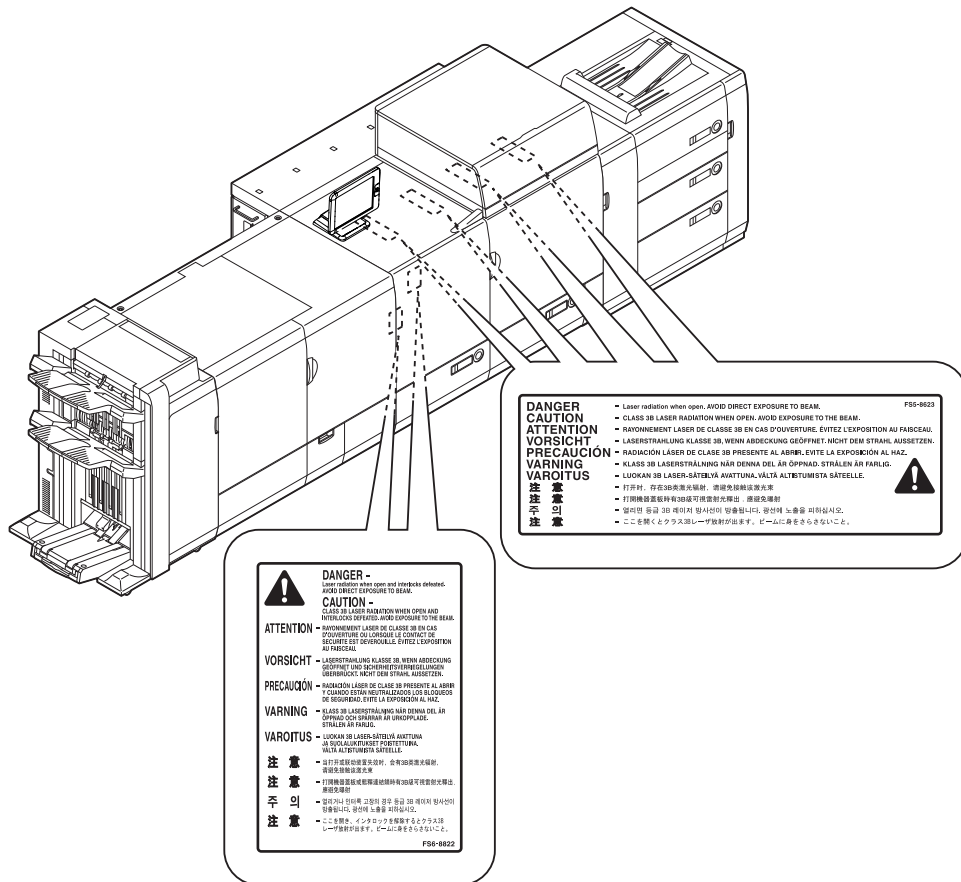

■ Inside the Marking Engine

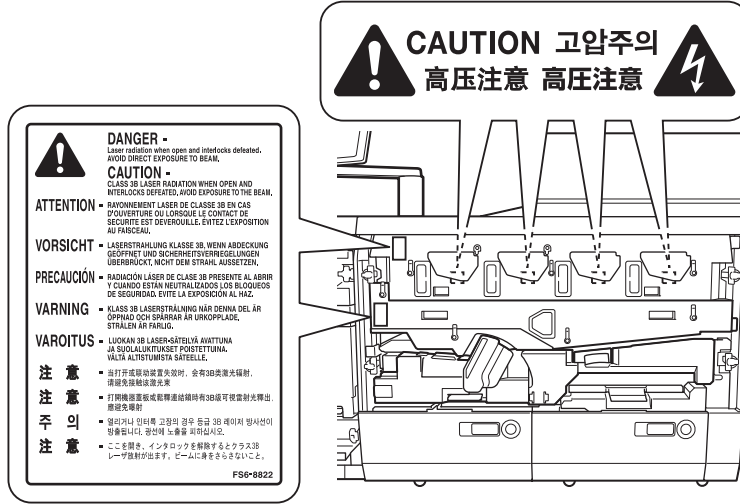

■ Back of the Marking Engine

This device complies with Part 15 of the FCC Rules. Operation is subject to the following two conditions: (1) This device may not cause harmful interference, and (2) this device must accept any interference received, including interference that may cause undesired operation.

This Class A digital apparatus meets all requirements of the Canadian Interference-Causing Equipment Regulations.

Cet appareil numérique de la classe A respecte toutes les exigences du Règlement sur le matériel brouilleur du Canada.

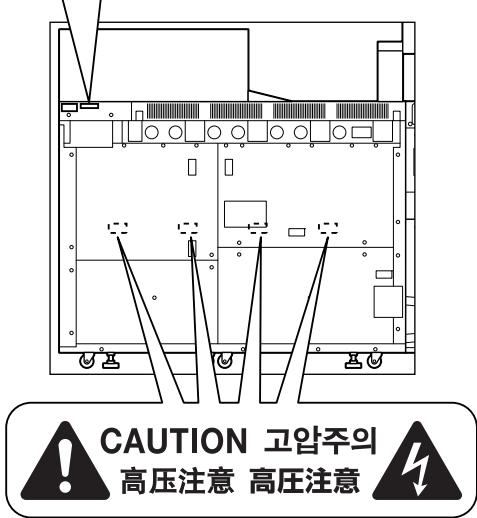

■ Back of the Power Supply Unit

200-240V
50/60Hz 1.2A

Warning: High Voltage (Lightning Bolt in Triangle)

TR1

CANON INC.
30-2, SHIMOMARUKO, 3-CHOME, OHTA-KU, TOKYO, JAPAN

MANUFACTURED:
THIS PRODUCT CONFORMS WITH DHHS RADIATION PERFORMANCE STANDARD 21CFR CHAPTER 1 SUBCHAPTER J.

This device complies with Part 15 of the FCC Rules. Operation is subject to the following two conditions: (1) This device may not cause harmful interference, and (2) this device must accept any interference received, including interference that may cause undesired operation.

This Class A digital apparatus meets all requirements of the Canadian Interference-Causing Equipment Regulations.

Cet appareil numérique de la classe A respecte toutes les exigences du Règlement sur le matériel brouilleur du Canada.

■ Inside the Fixing Station

CAUTION
ATTENTION
VORSICHT
ATENCIÓN
ATTENZIONE
CUIDADO
注意
주의
注意

■ Back of the Fixing Station

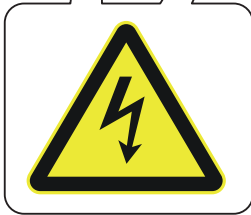
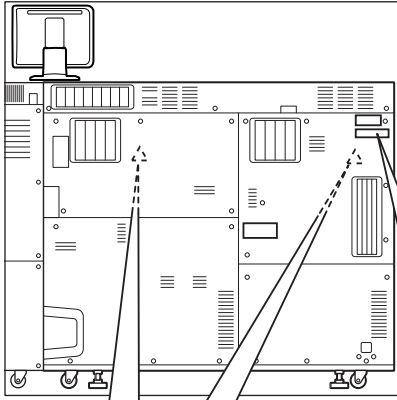

This device complies with Part 15 of the FCC Rules. Operation is subject to the following two conditions: (1) This device may not cause harmful interference, and (2) this device must accept any interference received, including interference that may cause undesired operation.

This Class A digital apparatus meets all requirements of the Canadian Interference-Causing Equipment Regulations.

Cet appareil numérique de la classe A respecte toutes les exigences du Règlement sur le matériel brouilleur du Canada.

4 Installation Location and Handling

This section describes precautions for installation location and handling. We recommend that you read this section prior to using this machine.

Installation Precautions

For more information, see the Installation and Operating Environment Guidelines. If you do not have it, contact your local authorized dealer.

Avoid Installing the Machine in the Following Locations

■ **Avoid locations subject to temperature and humidity extremes, whether low or high.**

For example, avoid installing the machine near water faucets, hot water heaters, humidifiers, air conditioners, heaters, or stoves.

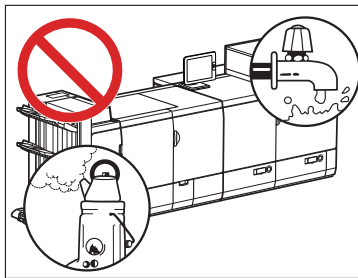

■ **Avoid installing the machine in direct sunlight.**

If this is unavoidable, use curtains to shade the machine. Be sure that the curtains do not block the machine's ventilation slots or louvers, or interfere with the electrical cord or power supply.

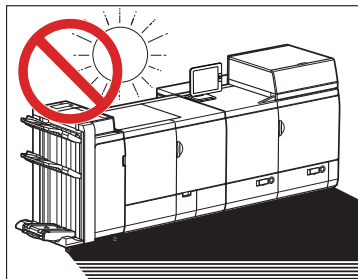

4

■ **Avoid poorly ventilated locations.**

This machine generates a slight amount of ozone etc. during normal use. Although sensitivity to ozone etc. may vary, this amount is not harmful. Ozone etc. may be more noticeable during extended use or long production runs, especially in poorly ventilated rooms. It is recommended that the room be appropriately ventilated, sufficient to maintain a comfortable working environment, in areas of machine operation.



■ **Avoid locations where a considerable amount of dust accumulates.**

■ **Avoid locations where ammonia gas is emitted.**

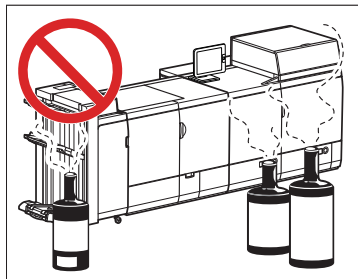

■ **Avoid locations near volatile or flammable materials, such as alcohol or paint thinner.**

■ **Avoid locations that are subject to vibration.**

For example, avoid installing the machine on unstable floors or stands.

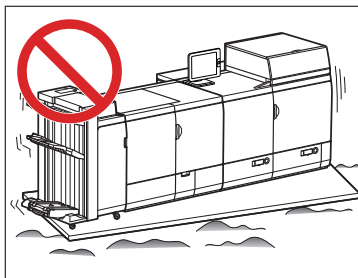

■ **Avoid exposing the machine to rapid changes in temperature.**

If the room in which the machine is installed is cold but rapidly heated, water droplets (condensation) may form inside the machine. This may result in a noticeable degradation in the quality of the copied image, the inability to properly scan an original, or the copies having no printed image at all.

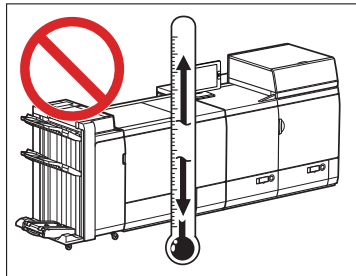

■ **Avoid installing the machine near computers or other precision electronic equipment.**

Electrical interference and vibrations generated by the machine during printing can adversely affect the operation of such equipment.

■ **Avoid installing the machine near televisions, radios, or similar electronic equipment.**

The machine might interfere with sound and picture signal reception. Insert the power plug into a dedicated power outlet, and maintain as much space as possible between the machine and other electronic equipment.

■ **Do not remove the machine's leveling feet.**

Do not remove the machine's leveling feet after the machine has been installed. If you put weight on the front of the machine while the paper decks or units within the machine are pulled out, the machine may fall forward. To prevent this from happening, make sure that the machine's leveling feet are in place.

Select a Safe Power Supply

- Plug the machine into a 3-phase 5-wire, 208V AC 30 A outlet (C7010VPS/C6010VPS/C6010S).
- Make sure that the power supply for the machine is safe, and has a steady voltage.
- Do not connect other electrical equipment to the same power outlet to which the machine is connected.
- Do not connect the power cord of the main unit and the optional power cord with the same power outlet.
- As a general rule, do not use extension cords. If an extension cord must be used, however, use another extension cord for a power cord of the main unit and a optional power cord, and supply a power from another power outlet.
- Do not connect the power cord to a multiplug power strip, as this may cause a fire or electrical shock.
- The power cord may become damaged if it is often stepped on or if heavy objects are placed on it. Continued use of a damaged power cord can lead to an accident, such as a fire or electrical shock.

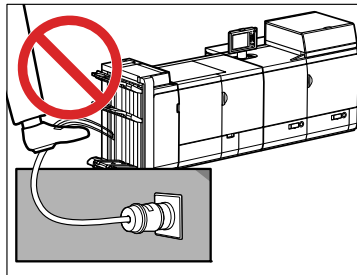

Provide Adequate Installation Space

- Provide enough space on each side of the machine for unrestricted operation.
- Keep the back of the machine at least 31 1/2" (800 mm) away from a wall.

The optional Saddle Finisher-AJ2 is attached.

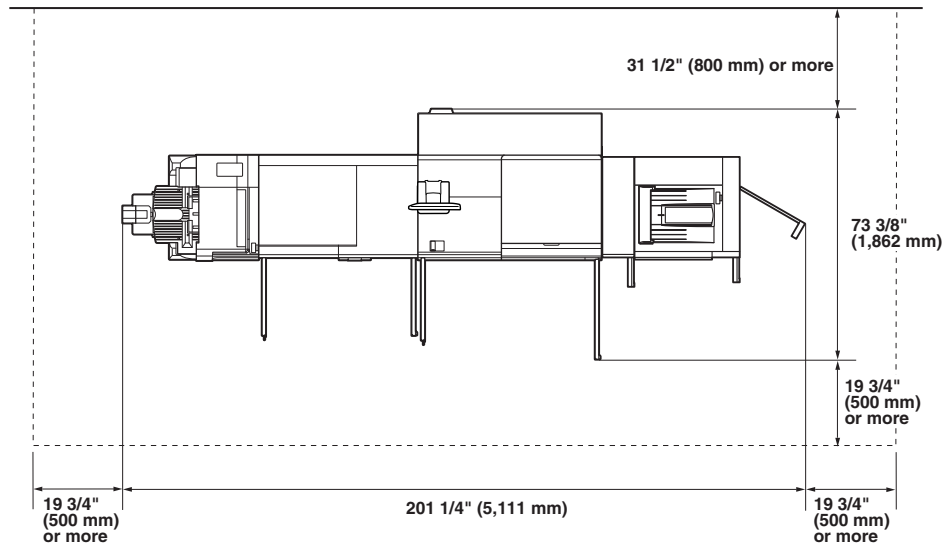

Maximum Configuration

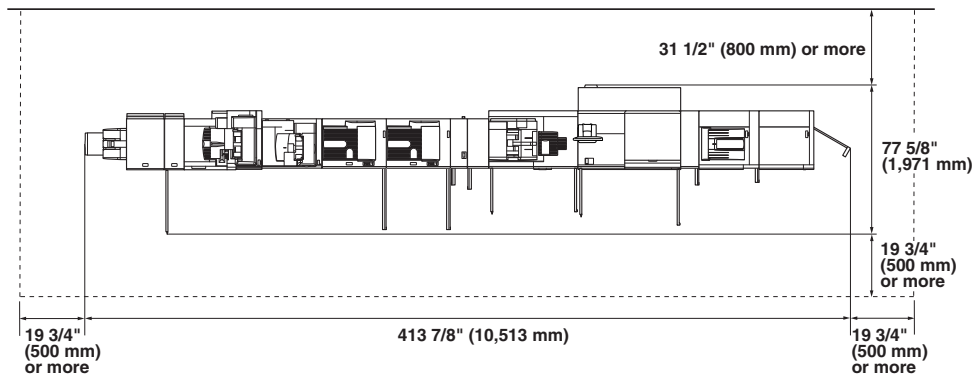

- Do not place anything around the machine.

Especially, do not place anything around the breaker, as doing so may prevent the breaker from being operated in an emergency, resulting in personal injury.

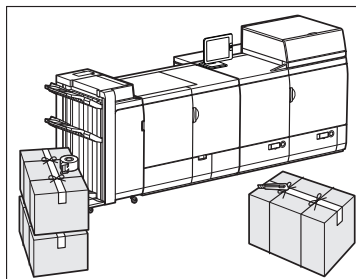

Moving the Machine

- If you intend to move the machine, even to a location on the same floor of your building, contact your local authorized dealer beforehand. Do not attempt to move the machine yourself.

Handling Precautions

- Do not attempt to disassemble or modify the machine.

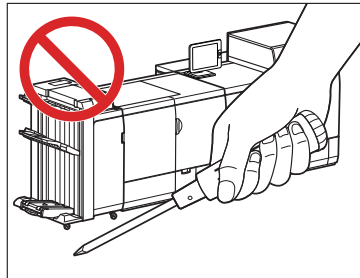

- Some parts inside the machine are subject to high-voltages and temperatures. Take adequate precautions when inspecting the inside of the machine. Do not carry out any inspections that are not described in this manual or the User Manual - Operating Information.

- Be careful not to spill liquid or drop any foreign objects, such as paper clips or staples inside the machine. If a foreign object comes into contact with electrical parts inside the machine, it may cause a short circuit and result in a fire or electrical shock.

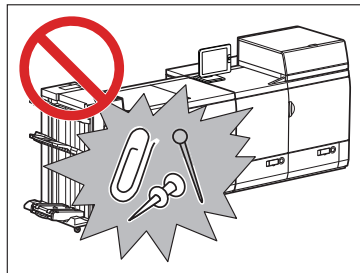

- If there is smoke, or unusual noise, immediately turn the main power switch OFF, disconnect the power cord from the power outlet, and then call your local authorized dealer. Using the machine in this state may cause a fire or electrical shock. Also, avoid placing objects around the power plug so that the machine can be disconnected whenever necessary.

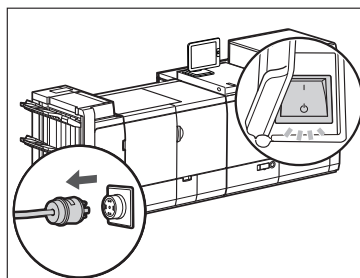

- Do not turn the main power switch OFF or open the front covers while the machine is in operation. This may result in paper jams.
- Do not use flammable sprays, such as spray glue, near the machine. There is a danger of ignition.

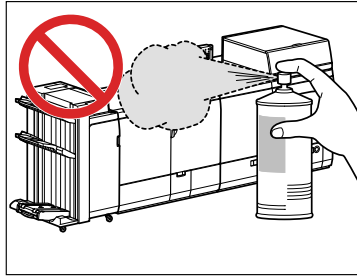

- This machine generates a slight amount of ozone etc. during normal use. Although sensitivity to ozone etc. may vary, this amount is not harmful. Ozone etc. may be more noticeable during extended use or long production runs, especially in poorly ventilated rooms. It is recommended that the room be appropriately ventilated, sufficient to maintain a comfortable working environment, in areas of machine operation.
- For safety reasons, turn OFF the machine when it will not be used for a long period of time, such as overnight. As an added safety measure, turn OFF the main power switch, and disconnect the power cord when the machine will not be used for an extended period of time, such as during consecutive holidays.
- Use a USB cable that is shorter than 9' 10" (3 meters).
- Paper that has just been output from the machine may be hot. Be careful when removing or aligning paper from the output tray. Touching paper right after it is output may result in low-temperature burns.

5 Periodic Inspection of the Breaker

This machine has a breaker that detects excess current or leakage current. Make sure to test the breaker once or twice a month using the following procedure.



IMPORTANT

If a malfunction occurs after an inspection, contact your local authorized dealer.

Checking the Breaker

1 Turn OFF the main power.

For instructions on turning the main power OFF, see User manual - Operating Information.

2 Push the test button.

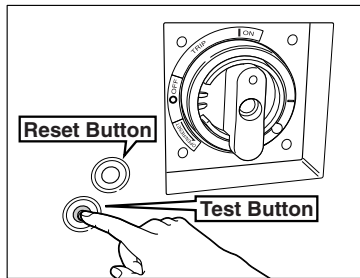

IMPORTANT

Briefly push the test button.



NOTE

- The breaker is located on the back of the marking engine.
- For more information on the location of the breaker, see User manual - Operating Information.

3 Confirm that the breaker dial is in the OFF ("O" side) position.

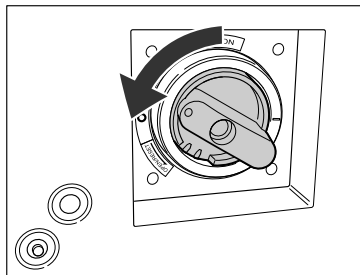

IMPORTANT

- Do not use the test button to turn the power ON and OFF.
- If the breaker dial does not turn to the OFF ("O" side) position, repeat step 2.
- If the breaker dial does not turn to the OFF ("O" side) position, despite carrying out the above procedure two or three times, contact your local authorized dealer.

4 Turn the breaker dial all the way down until it stops.

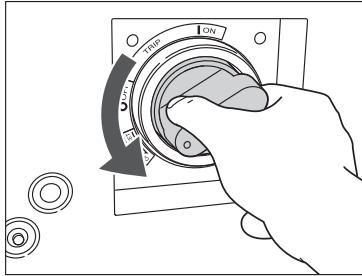

5 Turn the breaker dial to ON ("I" side).

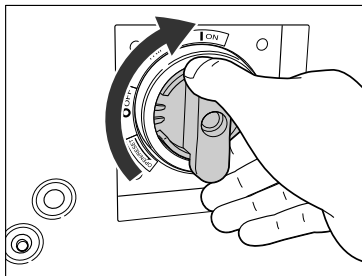

6 Press the main power switch to the "I" side.

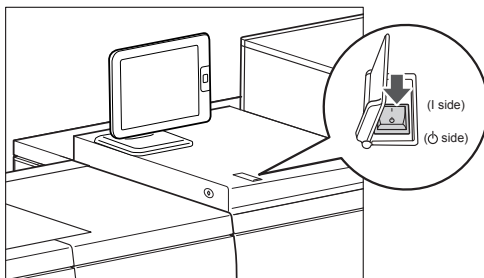

7 Fill in the check sheet, located on the next page, to document your periodic inspections of the breaker.



CANON INC.

30-2, Shimomaruko 3-chome, Ohta-ku, Tokyo 146-8501, Japan

CANON U.S.A., INC.

One Canon Plaza, Lake Success, NY 11042, U.S.A.

CANON CANADA INC.

6390 Dixie Road Mississauga, Ontario L5T 1P7, Canada

CANON EUROPA N.V.

Bovenkerkerweg 59-61 1185 XB Amstelveen, The Netherlands
(See <http://www.canon-europe.com/> for details on your regional dealer)

CANON LATIN AMERICA, INC.

703 Waterford Way Suite 400 Miami, Florida 33126 U.S.A.

CANON AUSTRALIA PTY. LTD

1 Thomas Holt Drive, North Ryde, Sydney, N.S.W. 2113, Australia

CANON CHINA CO., LTD

15F Jinbao Building No.89 Jinbao Street, Dongcheng District, Beijing 100005, China

CANON SINGAPORE PTE. LTD.

1 HarbourFront Avenue #04-01 Keppel Bay Tower, Singapore 098632

CANON HONGKONG CO., LTD

19/F., The Metropolis Tower, 10 Metropolis Drive, Hunghom, Kowloon, Hong Kong

Free Manuals Download Website

<http://myh66.com>

<http://usermanuals.us>

<http://www.somanuals.com>

<http://www.4manuals.cc>

<http://www.manual-lib.com>

<http://www.404manual.com>

<http://www.luxmanual.com>

<http://aubethermostatmanual.com>

Golf course search by state

<http://golfingnear.com>

Email search by domain

<http://emailbydomain.com>

Auto manuals search

<http://auto.somanuals.com>

TV manuals search

<http://tv.somanuals.com>