

Please carefully read and save these instructions before attempting to assemble, maintain, install, or operate this product. Observe all safety information to protect yourself and others. Failure to observe the instructions may result in property damage and/or personal injury. Please keep instructions for future reference.

Important Operating Instructions



2 GALLON TWIN STACK AIR COMPRESSOR

Model: 51735

CALIFORNIA PROPOSITION 65

WARNING: You can create dust when you cut, sand, drill or grind materials such as wood, paint, metal, concrete, cement, or other masonry. This dust often contains chemicals known to cause cancer, birth defects, or other reproductive harm. Wear protective gear.

WARNING: This product or its power cord may contain chemicals, including lead, known to the State of California to cause cancer and birth defects or other reproductive harm. Wash hands after handling.

CAUTION:

FOR YOUR OWN SAFETY READ INSTRUCTION MANUAL COMPLETELY AND CAREFULLY BEFORE OPERATING THIS OIL-FREE AIR COMPRESSOR KIT.

SPECIFICATIONS

Type: Twin Stack, Oil free

CFM: 1 CFM @ 40 PSI
.5 CFM @ 90 PSI

Horsepower: 1/4 HP

Maximum PSI: 100 PSI

GENERAL SAFETY WARNING

Please read and understand all instructions. Failure to follow all instructions listed below may result in electric shock, fire and/or serious personal injury.

Failure to comply with all electrical specifications may result in serious injury. All adjustments or repairs must be done with the compressor disconnected from the power source.

SAFETY INSTRUCTIONS

POWER SUPPLY

Your compressor must be connected to a 120V outlet, using a 15-amp time delay fuse or circuit breaker. Failure to connect in this way can result in injury from shock or fire.

GROUNDING

Your compressor must be properly grounded. Not all outlets are properly grounded. If you have hesitations on whether or not your outlet is properly grounded, have it checked by a qualified electrician.

WARNING: If not properly grounded, this compressor can cause electrical shock, particularly when used in damp locations. If the power cord is worn or damaged in any way have it replaced immediately.

If the compressor should breakdown, the grounding provides a path of least resistance for the electric current which reduces the risk of electric shock. The plug must be plugged into an appropriate outlet that is grounded in accordance with the local codes and ordinances.

WARNING: To maintain proper grounding, do not alter the grounding prong in any manner.

For warranty purchases, please keep your dated proof of purchase. File or attach to the manual for safekeeping.

120V OPERATION

As received from the factory, your compressor is ready to run for 120V operation. This machine is intended for use on a circuit that has an outlet and a plug which looks like the one illustrated in Fig. 1.

WARNING: Do not use a two-prong adapter.

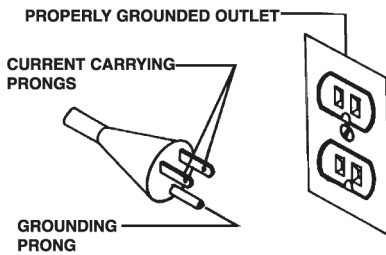

FIGURE 1

EXTENSION CORDS

The use of any extension cord will cause some loss of power. It is recommended to use a longer air hose instead of an extension cord. Use the chart below to determine the minimum wire size extension cord. Use only 3-wire extension cords which have 3-prong grounding type plugs and 3-hole receptacles which accept the tool's plug.

For circuits that are further away from the electrical circuit box, the wire size must be increased proportionately in order to deliver ample voltage to the motor. Refer to Fig. 2 for wire length and size.

LENGTH OF CONDUCTOR	WIRE SIZES REQUIRED (AMERICAN WIRE GAUGE) 120V LINES
0-25 FEET	NO. 16
26-50 FEET	NO. 16
51-100 FEET	NO. 14

OPERATION CONTROLS

CHECK VALVE

When the compressor is operating, the check valve is "open", allowing compressed air to enter the air tank. When the air compressor reaches "Cut-Out" pressure, the check valve "closes", allowing air pressure to remain inside the air tank.

ON/OFF SWITCH (A) FIG. 3

Turn this switch ON (press downwards) to provide power to the automatic pressure switch and OFF to remove power at the end of each use.

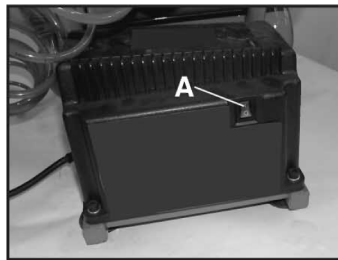

FIGURE 3

PRESSURE SWITCH

The pressure switch automatically starts the motor when the tank pressure drips below the factory set "Cut-in" pressure. It also stops the motor when the air tank pressure reaches the factory set "Cut-Out" pressure.

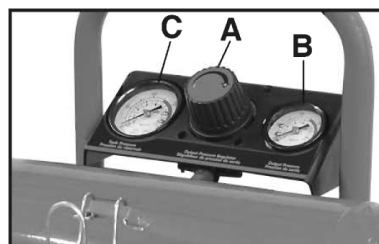

FIGURE 4

REGULATOR (A) FIG. 4

The air pressure coming from the air tank is controlled by the regulator. Turn the regulator knob clockwise to increase pressure counterclockwise to decrease pressure. To avoid minor readjustment after making a change in the pressure setting always approach the desired pressure from a lower pressure. When reducing from a higher to lower setting, first reduce the pressure less than that desired then bring it up to the desired pressure. Depending on the air requirements of each particular accessory, the outlet regulated pressure may have to be adjusted while operating the accessory.

OUTLET PRESSURE GAUGE FIG. 4

The tank pressure gauge indicates the reserve air pressure in the

TANK PRESSURE GAUGE (C) FIG. 5

Indicates the available reserve pressure in the tank.

DRAIN VALVE (A) FIG. 5

The drain valve is located on the base of the air tank and is used to drain condensation at the end of each use.

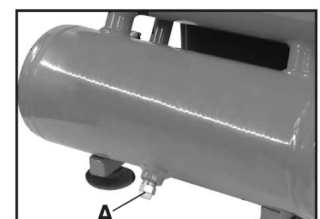

SAFETY PRESSURE RELEASE VALVE (A) FIG. 6

If the pressure switch does not shut off the air compressor at its cutout pressure setting and the air pressure keeps rising, the safety valve will protect against high pressure by “popping out” above factory set pressure (slightly higher than the pressure switch cut-out setting).

WARNING: If the safety pressure release valve does not work properly, over pressurization may occur, causing air tank to rupture or explode. Pull the ring on the safety valve daily to make sure that the safety valve operates freely. If the valve is stuck or does not operate smoothly, it must be replaced with the same type of valve.

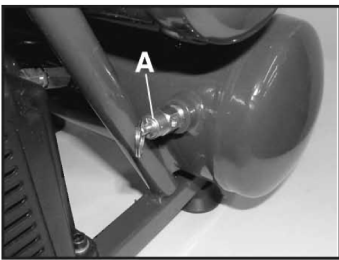

FIGURE 6

SETTING UP YOUR AIR COMPRESSOR

Operate the air compressor in a dry, clean and well ventilated area. Clean off dust or dirt that collects on the air compressor. A clean air compressor runs cooler and provides longer service. The ventilation openings on your air compressor are necessary to maintain proper operating temperature. Do not place rags or other containers near these openings.

ADDITIONAL REGULATORS AND CONTROLS

Since the air tank pressure is usually greater than that which is needed, a regulator is employed to control the air pressure ahead of any individual driven device. Separate air transformers which combine the function of air regulation, moisture and dirt removal should be used where applicable.

PREPARATION FOR USE

- 1) Before attaching the air hose or accessories, make sure the On/Off switch is set to “OFF” and the air regulator is closed (completely turned counterclockwise).
- 2) Attach the 1/4in. female fitting (A Fig.7) to one end of the coil hose (B), then connect the female fitting (A) into the quick connect outlet (C) at the back of the compressor, then attach the 1/4in. female quick connect (D) to the other end of the coil hose. Attach optional air tool or supplied accessories. To prevent air leaks, it is recommended to install Teflon Tape (not supplied) on the threads at both ends of the coil hose.

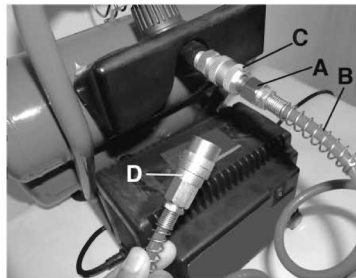

FIGURE 7

- 5) Turn the switch to the On position and allow tank pressure

to reach “cut-out” pressure.

- 6) Open the regulator by turning it clockwise. Adjust the regulator to the correct pressure setting. The compressor is ready.

WARNING: Too much air pressure causes a hazardous risk of bursting. Check the manufacturer’s maximum pressure rating for air tools and accessories. The regulator outlet pressure must never exceed the maximum pressure rating of the tool being used.

AFTER USE

- 1) Set the switch to Off.
- 2) Turn the regulator counterclockwise to set the outlet pressure to zero.
- 3) Disconnect the air tool or accessory.
- 4) Pull ring on safety valve (A) Fig.6, allowing air to bleed from the tank until tank pressure is approximately 20 PSI. Release safety valve ring
- 5) Drain water from air tank. Turn drain valve (A) Fig. 5 counterclockwise to open.

WARNING: Water will condense in the air tank. The water will corrode and weaken the air tank causing a risk of air tank rupture if it is not drained properly.

NOTE: If drain valve is plugged, pull ring on safety valve (A) Fig.6, and hold until all air pressure has been

then be removed, cleaned, and reinstalled.

6. After the water has been completely drained, turn the drain valve to close. The air compressor can now be stored.

MAINTENANCE

Before doing any maintenance or adjustments to your air compressor, the following safety precautions should be taken:

- Disconnect electrical power.
- Release air tank pressure.

DAILY OR BEFORE EACH USE

- 1) Drain condensation from tank.
- 2) Check for unusual noise or vibration.
- 3) Be sure all nuts and bolts are tight.

KEEP TOOL CLEAN

Periodically blow out all air passages with dry compressed air. Clean all plastic parts with a soft damp cloth. NEVER use solvents to clean plastic parts. This could possibly dissolve or otherwise damage the material.

CAUTION: Wear safety glasses while using compressed air.

FAILURE TO START

Should your compressor fail to start, check to make sure the prongs on the cord plug are making good contact with the outlet. Also, check compressor fuse or tripped circuit breakers in the line.

REPLACEMENT PARTS

For servicing, contact or return to the retailer where you purchased your product along with your proof of purchase. Please use the 10-digit part numbers listed in this manual for all part orders where applicable.

Troubleshooting Guide

Symptom	Possible Cause(s)	Corrective Action
No start condition	Fuse blown or circuit breaker tripped	Check for cause of blown fuse/breaker and replace
	loose electrical connections	Check wiring connections
	Overheated motor	Turn compressor off, wait until total cool down before restarting
Low pressure	Air leak in safety valve	Check valve manually by pulling upwards on ring. If condition persists, replace valve
	Defective check valve	Replace check valve
Safety valve releasing	Defective pressure switch or improper adjustment	Check for proper adjustment and if problem persists, replace pressure switch
Tank pressure drops when compressor is shut off	Loose drain valve	Tighten drain valve
	Loose connections at regulator or pressure switch	Check connections for leaks, seal with teflon tape
Excessive moisture coming out of air hose	Excessive water in tank	Drain tank through drain valve
	Humidity too high	Move compressor to an area of less humidity.

Limited Manufacturer Warranty

North American Tool (NAT) Industries makes every effort to ensure that this product meets high quality and durability standards. NAT warrants to the original retail consumer a 1-year limited warranty from the date the product was purchased at retail and each product is free from defects in materials. Warranty does not apply to defects due directly or indirectly to misuse, abuse, negligence or accidents, repairs or alterations, or a lack of maintenance. NAT shall in no event be liable for death, injuries to persons or property, or for incidental, special or consequential damages arising from the use of our products. To receive service under warranty, the original manufacturer part must be returned for examination by an authorized service center. Shipping and handling charges may apply. If a defect is found, NAT will either repair or replace the product at its discretion.



2 GALLON TWIN STACK AIR COMPRESSOR

Models: 5173

Parts List

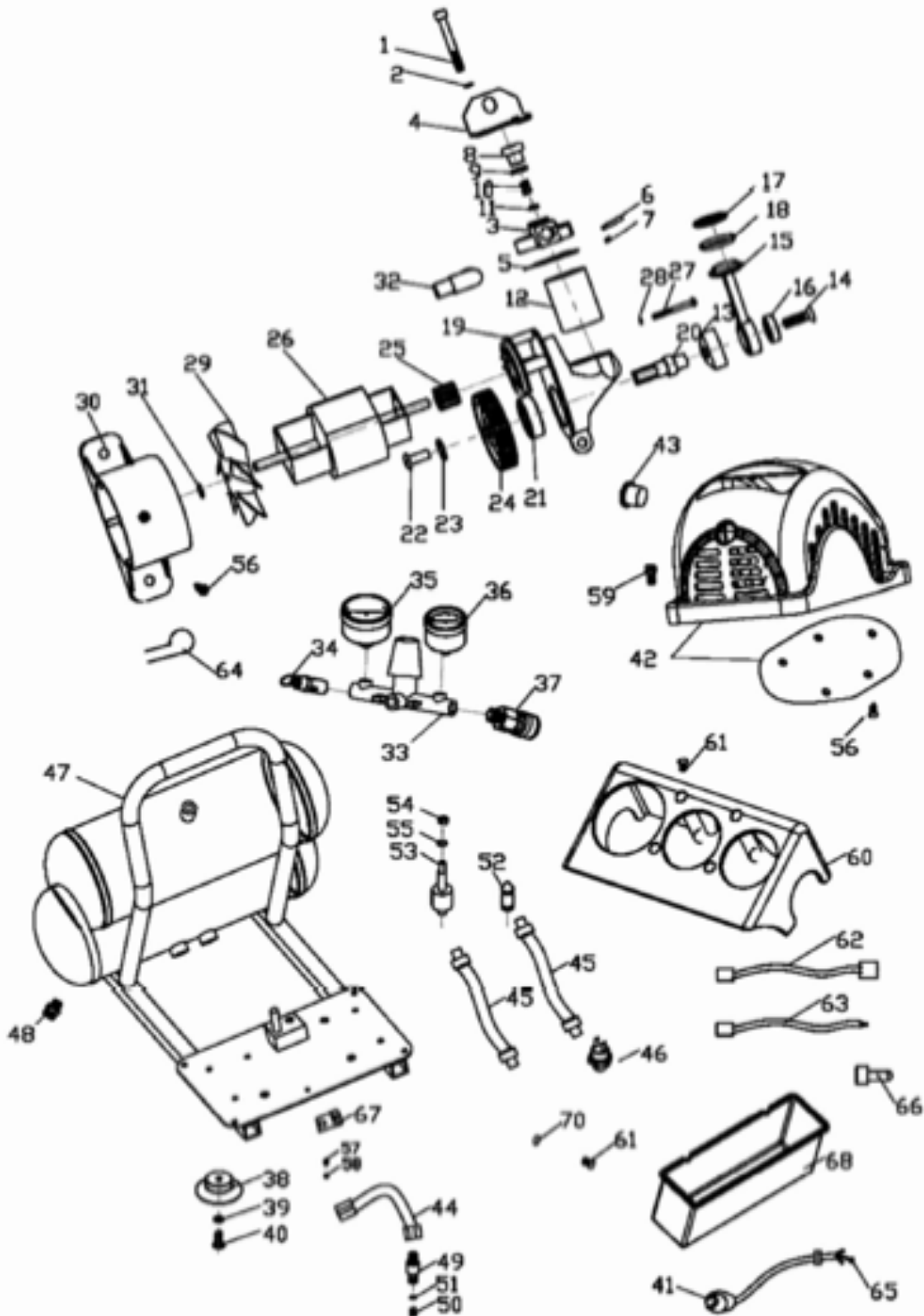

Call 1-800-348-5004 for assistance or replacement parts

Please provide the following information:

- Model number
- Part description and number as shown in parts list
- Serial number (if any)

Address any correspondence to:

North American Tool Industries
 84 Commercial Rd
 Huntington, IN 46750

#	Description	QTY
1	Bolt M5x55	3
2	Spring Washer M5	3
3	Cylinder Head	1
4	Support of Cylinder Head	1
5	Gasket of Cylinder Head	1
6	Inlet Valve Reed	1
7	Cover of Valve Reed	1
8	Plug of Exhaust	1
9	O-Ring of Plug	1
10	Inlet Spring	1
11	Gasket for Exhausting	1
12	Cylinder	1
13	Eccentric	1
14	Screw M6x15	1
15	Conrod	1
16	Bearing of Conrod	1
17	Cover of Conrod	1
18	Piston Ring	1
19	Crankcase	1
20	Axle	1
21	Bearing of Crankcase	1
22	Screw M5x10	1
23	Washer M5	1
24	Driven Gear	1
25	Active Gear	1
26	Motor	1
27	Screw M3x30	2
28	Spring Washer M3	2
29	Fan	1
30	Cover of Motor	1
31	Circlip M6	1
32	Exhaust Elbow	1
33	Regulator Manifold	1
34	Safety Valve	1

#	Description
35	Y50 Pressure Gauge
36	Y40 Pressure Gauge
37	Quick Coupler
38	Cushion
39	Washer M5
40	Screw M5x20
41	Power Cord
42	Shroud
43	Electric Switch
44	Exhaust Tube
45	Rubber Hose
46	Pressure Switch
47	2 Gal Twin Tank
48	Drain Valve
49	Connect of Check Valve
50	Spring of Check Valve
51	Seal Gasket of Check Valve
52	Support Rubber
53	Support Bolt
54	Nut M6
55	Spring Washer M6
56	Tapping Screw
57	Screw M4x6
58	Washer M4
59	Screw M6x25
60	Control Panel of Manifold
61	Screw M4x10
62	Dual End Cord
63	Single End Cord
64	R Type Wrap
65	Cable Connector
66	Cap Press for Cord
67	Grounding Signal
68	Tool Box

Free Manuals Download Website

<http://myh66.com>

<http://usermanuals.us>

<http://www.somanuals.com>

<http://www.4manuals.cc>

<http://www.manual-lib.com>

<http://www.404manual.com>

<http://www.luxmanual.com>

<http://aubethermostatmanual.com>

Golf course search by state

<http://golfingnear.com>

Email search by domain

<http://emailbydomain.com>

Auto manuals search

<http://auto.somanuals.com>

TV manuals search

<http://tv.somanuals.com>