



DR-G2140

DR-G2110

DR-G2090

User Manual

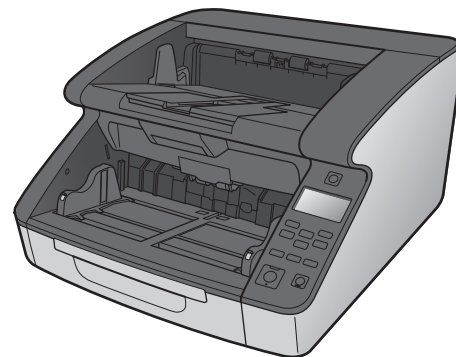

- Please read this manual before operating this scanner.
- After you finish reading this manual, store it in a safe place for future reference.

FCC REGULATIONS (For 120 V model)

Document Scanner, Model 6130020/6130030/6130040/6130130/6130140

This device complies with Part 15 of the FCC Rules. Operation is subject to the following two conditions: (1) This device may not cause harmful interference, and (2) this device must accept any interference received, including interference that may cause undesired operation.

Note: This equipment has been tested and found to comply with the limits for a Class B digital device, pursuant to Part 15 of the FCC Rules. These limits are designed to provide reasonable protection against harmful interference in a residential installation. This equipment generates, uses, and can radiate radio frequency energy and, if not installed and used in accordance with the instructions, may cause harmful interference to radio communications. However, there is no guarantee that interference will not occur in a particular installation. If this equipment does cause harmful interference to radio or television reception, which can be determined by turning the equipment OFF and ON, the user is encouraged to try to correct the interference by one or more of the following measures:

- Reorient or relocate the receiving antenna.
- Increase the separation between the equipment and receiver.
- Connect the equipment into an outlet on a circuit different from that to which the receiver is connected.
- Consult the dealer or an experienced radio/TV technician for help.

Use of shielded cable is required to comply with Class B limits in Subpart B of Part 15 of FCC Rules.

Do not make any changes or modifications to the equipment unless otherwise specified in the manual. If such changes or modifications should be made, you could be required to stop operation of the equipment.

Canon U.S.A. Inc.

ONE CANON PARK, MELVILLE, NY 11747, U.S.A.

Tel. No. (800)652-2666

RADIO INTERFERENCE REGULATIONS (For 120 V models)

This digital apparatus does not exceed the Class B limits for radio noise emissions from digital apparatus as set out in the interference-causing equipment standard entitled “Digital Apparatus”, ICES-003 of the Industry Canada.

RÈGLEMENT SUR LE BROUILLAGE RADIOÉLECTRIQUE (For 120 V models)

Cet appareil numérique respecte les limites de bruits radioélectriques applicables aux appareils numériques de Classe B prescrites dans la norme sur le matériel brouilleur: “Appareils Numériques”, NMB-003 édictée par l’Industrie Canada.

ENERGY STAR® Office Equipment Program



This program is for U.S.A and Canada.

As an ENERGY STAR® Partner, CANON ELECTRONICS INC. has determined that this machine meets the ENERGY STAR® Program guidelines for energy efficiency.

The ENERGY STAR® Office Equipment Program is an international program that promotes energy saving through the use of computers and other office equipment. The program backs the development and dissemination of products with functions that effectively reduce energy consumption. It is an open system in which business proprietors can participate voluntarily. The targeted products are office equipment, such as computers, monitors, printers, fax, machine, copiers, and scanners. The standards and logos are uniform among participating nations.

This model doesn't provide setting options for power management.

European Union (and EEA) only.



This symbol indicates that this product is not to be disposed of with your household waste, according to the WEEE Directive (2002/96/EC) and your national law. This product should be handed over to a designated collection point, e.g., on an authorized one-for-one basis when you buy a new similar product or to an authorized collection site for recycling waste electrical and electronic equipment (EEE). Improper handling of this type of waste could have a possible negative impact on the environment and human health due to potentially hazardous substances that are generally associated with EEE. At the same time, your cooperation in the correct disposal of this product will contribute to the effective usage of natural resources. For more information about where you can drop off your waste equipment for recycling, please contact your local city office, waste authority, approved WEEE scheme or your household waste disposal service. For more information regarding return and recycling of WEEE products, please visit www.canon-europe.com/environment. (EEA: Norway, Iceland and Liechtenstein)

Für EMVG

Dieses Produkt ist zum Gebrauch im Wohnbereich, Geschäfts-und Gewerbebereich sowie in Kleinbetrieben vorgesehen.

Model Names

The following name may be provided for the safety regulations in each sales region of the Document Scanner.

DR-G2140: Model 6130020/6130130

DR-G2110: Model 6130030/6130140

DR-G2090: Model 6130040

Reproduction Warning

This device is designed to be used in a legal manner, in accordance with all applicable laws, including, but not limited to, counterfeit and copyright laws, as well as laws pertaining to national security. Any person(s) found to have reproduced any of the following materials (regardless of whether such reproduction was intentional or not) for the purpose of misrepresenting such material as the original may be prosecuted in accordance with the applicable laws and regulations.

- Paper money or bank notes (domestic and foreign)
- Postage stamps, revenue stamps, or other similar stamps
- Stock certificates, bond certificates, promissory notes, cheques, or other valuable certificates
- Passports, licenses, or other certificates or documents issued by government officials or agencies

This is not an exhaustive list.

Canon is not responsible for how this scanner is used by an individual. Please note that certain intellectual property is protected by copyright law, and copyrighted items may not be reproduced without the express permission of the copyright holder except for personal or household use under limited circumstances.

Trademarks

- Canon and the Canon logo are registered trademarks, of Canon Inc. in the United States and may also be trademarks or registered trademarks in other countries.
- imageFORMULA is a trademark of CANON ELECTRONICS INC.
- Microsoft, Windows, PowerPoint, and SharePoint are registered trademarks or trademarks of Microsoft Corporation in the United States and other countries.
- Microsoft product screen shot(s) reprinted with permission from Microsoft Corporation.
- ENERGY STAR® is a registered trademark of the United States Environmental Protection Agency.
- ISIS is a registered trademark of Open Text in the United States.
- Other product and company names herein may be the trademarks of their respective owners. However, the ™ and ® symbols are not used in this document.

Copyright

Copyright 2018 by CANON ELECTRONICS INC. All rights reserved. No part of this publication may be reproduced or transmitted in any form or by any means, electronic or mechanical, including photocopying and recording, or by any information storage or retrieval system without the prior written permission of CANON ELECTRONICS INC.

Disclaimers

The information in this document is subject to change without notice.

CANON ELECTRONICS INC. MAKES NO WARRANTY OF ANY KIND WITH REGARD TO THIS MATERIAL, EITHER EXPRESS OR IMPLIED, EXCEPT AS PROVIDED HEREIN, INCLUDING WITHOUT LIMITATION, THEREOF, WARRANTIES AS TO MARKETABILITY, MERCHANTABILITY, FITNESS FOR A PARTICULAR PURPOSE OF USE OR NON-INFRINGEMENT. CANON ELECTRONICS INC. SHALL NOT BE LIABLE FOR ANY DIRECT, INCIDENTAL, OR CONSEQUENTIAL DAMAGES OF ANY NATURE, OR LOSSES OR EXPENSES RESULTING FROM THE USE OF THIS MATERIAL.

CANON ELECTRONICS INC. IS NOT LIABLE FOR THE STORAGE AND HANDLING OF DOCUMENTS SCANNED WITH THIS PRODUCT, OR THE STORAGE AND HANDLING OF RESULTING SCANNED IMAGE DATA.

IF YOU INTEND TO DISCARD THE ORIGINALS OF SCANNED DOCUMENTS, YOU THE CUSTOMER ARE RESPONSIBLE FOR INSPECTING THE SCANNED IMAGES AND VERIFYING THAT DATA IS INTACT. THE MAXIMUM LIABILITY OF CANON ELECTRONICS INC. UNDER THIS WARRANTY IS LIMITED TO THE PURCHASE PRICE OF THE PRODUCT COVERED BY THE WARRANTY.

STEP 1 Checking Your Purchased Model

Scanner Models

Scanner models include those with USB connector only, and those with both USB and wired LAN connectors. This manual describes both USB and wired LAN connection functions. Check your model before reading this manual.

Model	Serial No.*	USB Connection	Wired LAN Connection
DR-G2140 (with LAN connector)	JF	Yes	Yes
DR-G2140 (without LAN connector)	JS	Yes	No
DR-G2110 (with LAN connector)	JG	Yes	Yes
DR-G2110 (without LAN connector)	JT	Yes	No
DR-G2090	JH	Yes	No

*The serial number is alphanumeric characters printed on a label on the bottom/back of the product.

STEP 2

Checking the Accessories

If any of the items listed below are missing or damaged, contact your local authorized Canon dealer or service representative.

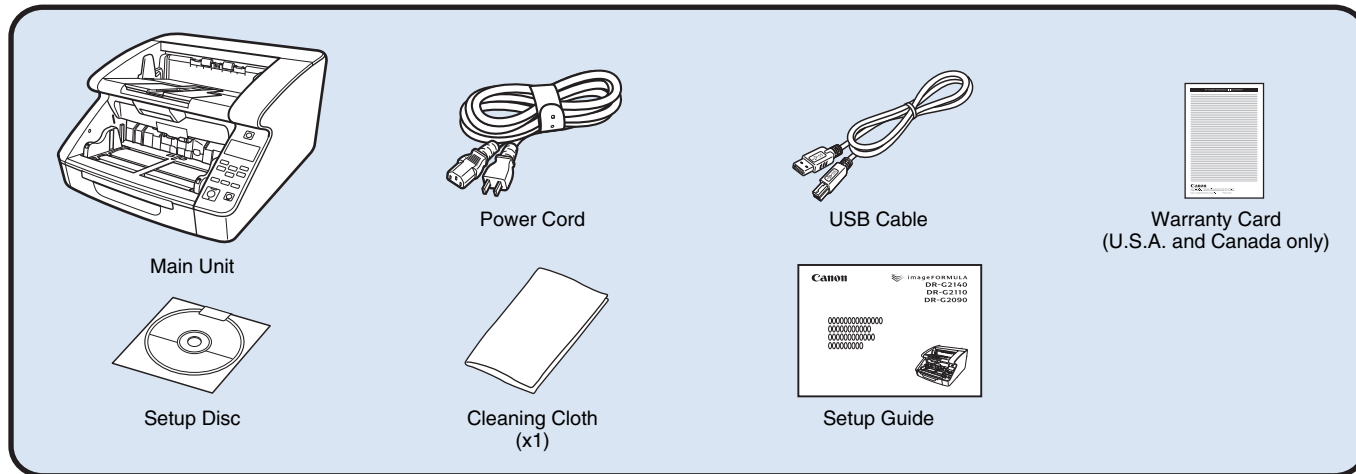

- The cleaning cloth is for cleaning the interior of the scanner.
- Items included in this manual are subject to change without notice.
- You must keep the machine's packaging and packing materials for storing or transporting the machine.
- The shape of the power plug varies by country and region.

Setup Disc Contents

Install the following software necessary for using the scanner from the supplied Setup Disc.

- **CaptureOnTouch**

This is a dedicated scanning application for DR Series scanners.

- **Scanner driver**

This is the scanner driver for this product.

STEP 3

Installing the Software

System requirements

To use the scanner, your computer must satisfy the following system requirements.

Computer

CPU:	Intel Core i3 2.13GHz or faster
Memory:	4GB or more
Hard disk:	3 GB or more available space required for installation of all software
USB interface:	USB3.1 Gen1/USB2.0
Monitor:	Resolution of 1024 × 768 (XGA) or better recommended.
Optical drive:	Drive capable of reading CDs/DVDs.

Operating system

- Microsoft Windows 7 Service Pack 1 or later (32-bit and 64-bit editions)
- Microsoft Windows 8.1 (32-bit and 64-bit editions)
- Microsoft Windows 10 (32-bit and 64-bit editions)
- Microsoft Windows Server 2008 R2 Service Pack 1 or later
- Microsoft Windows Server 2012 R2
- Microsoft Windows Server 2016

This is the environment as of August 2018.

For the latest software support information, go to the Products page on the Canon website.

Other requirements

- An ISIS-compatible application (Windows only) or a TWAIN-compatible application that is compatible with the above operating systems.
- .NET Framework 4.5 or later

IMPORTANT

- If you connect this scanner to a USB3.1 Gen1 enabled USB port, some computers may not recognize the scanner. If unrecognized, connect it to a USB2.0 port.
- Use the USB interface provided as standard with your computer. However, normal operation is not guaranteed with all USB interfaces, even if present as standard equipment on the computer. For details, consult your local authorized Canon dealer.
- Scanning speeds are lower if your computer's standard USB interface is USB Full-Speed (equal to USB 1.1.)
- The USB cable you are using should be the one originally included with the scanner.
- If the CPU, memory, interface card, and other specifications do not satisfy the installation requirements, the scanning speed may be greatly reduced and transmission may take a long time.
- Even if the computer satisfies the system requirements, the scanning speed may vary, depending on the specification of the computer and the environment.
- The scanner drivers provided with the scanner do not necessarily operate on all ISIS or TWAIN-compatible applications. For details, contact your application software retailer.
- In Windows 10 tablet mode, the software may disrupt the display.
- The Desktop Experience feature must be enabled for Windows Server 2008 R2 and Windows Server 2012 R2.

Installation

! IMPORTANT

- Install the software before connecting the scanner to the computer with the USB cable.
- Log on to Windows as an Administrator.
- Close all other applications before installing the software.

1 Insert the Setup Disc into the disk drive of the computer.

The setup menu automatically starts up when you insert the disc into the drive. (If the menu does not start up, execute setup.exe from the disc.)

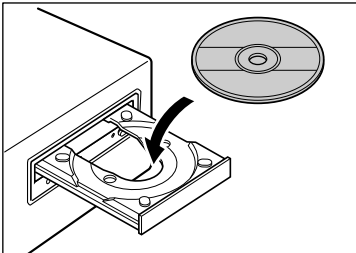

If the following screen appears, click [Yes] or [Permissions].

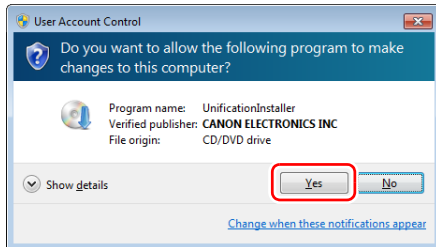

2 Click [Typical Installation].

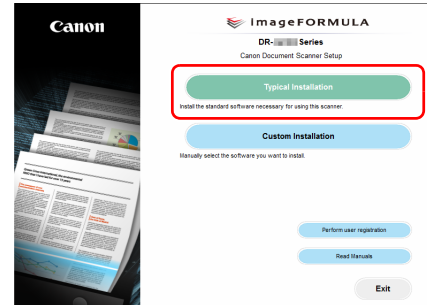

💡 Hint

If you want to reinstall only specific software that you have previously uninstalled, select [Custom Installation] and specify the software.

3 Click [Install].

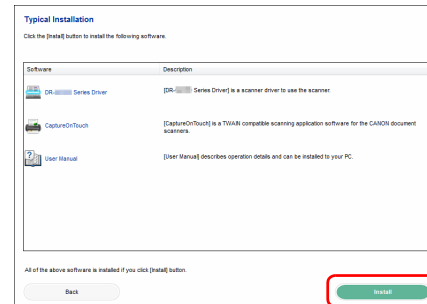

4 Follow the instructions on the screen to complete installation.

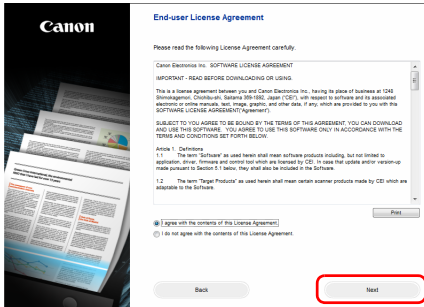

5 Click [Exit] to finish installing the software.

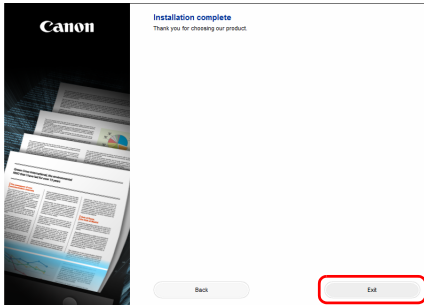

* Download the latest software from the Canon website.

Hint

Depending on your system environment, your web browser may start up full screen during installation. In that case, return to the desktop after processing in the browser is completed, and continue the installation process.

STEP 4

Connecting to a Computer and the Power

Connect the scanner to the computer and the power supply. The scanner can be connected to a USB port or LAN port on the computer.

! IMPORTANT

Before connecting the scanner to the computer, verify that the power of the scanner is OFF. If the power is ON, turn it OFF.

Interface Connector Locations

The USB connector is located on the scanner as shown below.

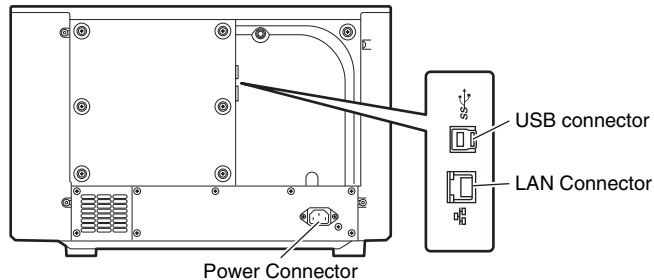

! IMPORTANT

Use only the supplied power cord.

Power Supply Connection

- 1 Connect the supplied power cord into the power connector on the back of the scanner. (1)
- 2 Connect the power cord into an AC outlet. (2)

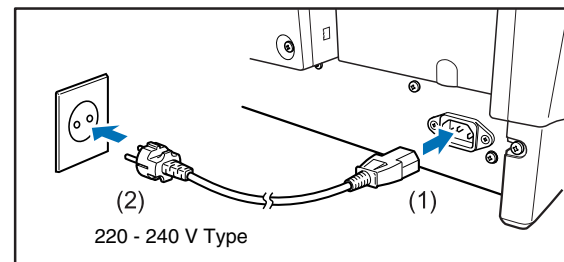
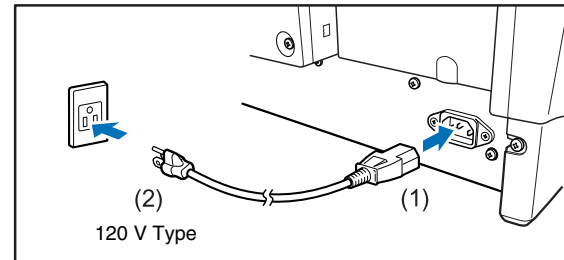

Connecting to a Computer

The scanner supports either USB connection or wired LAN connection. The scanner automatically recognizes the connection method when the USB cable or the LAN cable is connected.

! IMPORTANT

- This connection method remains effective until the power to the scanner is turned off. To change the connection method, disconnect the cable, restart the scanner, and connect the other cable.
- When the scanner starts up, if both the USB cable and the LAN cable are connected, the USB connection takes precedence.

Connecting via USB

Use the included USB cable to connect to the computer.

! IMPORTANT

Do not connect the scanner to the computer before installing the software.

The end of the USB cable with the square plug (Type B) connects to the scanner. The other end with the flat plug (Type A) connects to a USB port on the computer.

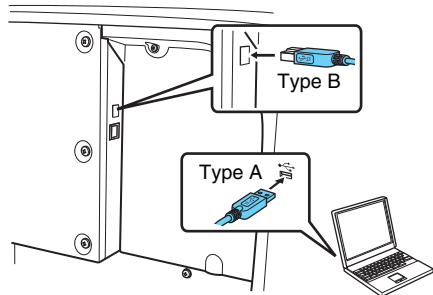

Connecting via wired LAN

Use a LAN cable to connect the scanner to a wired LAN router.

! IMPORTANT

- The computer needs to be connected to the router via wired or wireless LAN.
- The router and LAN cable are not included, and must be provided separately.

💡 Hint

- The scanner supports DHCP (Dynamic Host Configuration Protocol). A DHCP server in the network environment provides IP addresses that can be automatically acquired, eliminating the need to specify an IP address for the scanner.
- If you must specify a fixed IP address for the scanner, such as when using it on a network without a DHCP server, you can specify a static IP address on the operation panel or from the Web Menu. "Network" (See p. 71), "Web Menu" (See p. 98)
- When connecting via wired LAN, the optional flatbed scanner cannot be used.

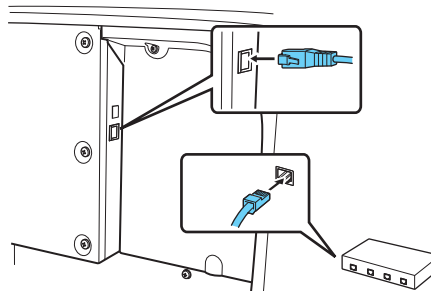

STEP 5

Turning the Power ON

The power of the scanner can be turned ON and OFF with the power switch on the front of the scanner.

1 Make sure that the scanner and computer are connected properly.

2 Press the power switch.

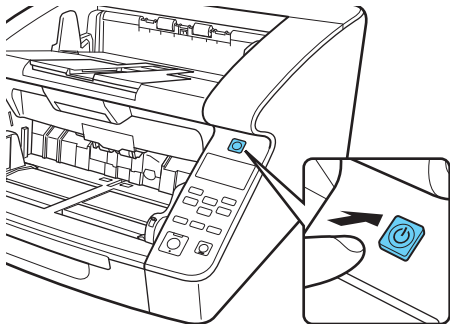



Power Switch

The power button lights green when the power turns ON.

Hint

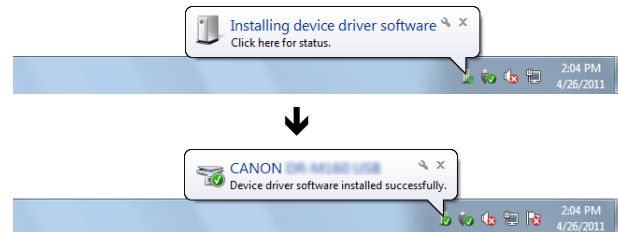
- When connected with the USB cable, the following message balloon appears on the task bar when the scanner's power switch is turned on the first time. If you wait a while, automatic scanner recognition will end and the scanner will become ready to use.



- When the scanner is properly connected to the computer, the  (CaptureOnTouch) icon appears on the taskbar as follows.



If the taskbar icon appears as , the scanner is not properly connected to the computer. Check the status of the power switch and the USB or LAN cable.

Turning Off the Power

Press and hold the power switch to turn it off.

IMPORTANT

- After turning the scanner off, wait at least 10 seconds before turning it back on.
- If you will not be using the scanner for an extended period, you should disconnect the power cord from the AC outlet for safety.

Hint

The scanner's auto power off setting is enabled by default, and the scanner will turn off automatically if it is not operated for 4 hours.

To override this setting, please [see "About the Canon imageFORMULA Driver Setting Tool" on p. 96.](#)

This completes setup.

Introduction

Thank you for purchasing the Canon imageFORMULA DR-G2140/DR-G2110/DR-G2090.

Please read the following manuals carefully and familiarize yourself with the functions of the scanner before use to ensure you sufficiently understand the functions and make the most of the scanner's capabilities. After reading the manuals, store them in a safe place for future reference.

Manuals for the Scanner

Documentation for this scanner consists of the following manuals.

● Setup Guide

This describes setup procedures for the scanner. Read this manual when you first use the scanner.

● User Manual (this manual)

This manual contains the operating procedures of the scanner.



Hint

- The manual (User Manual) for this scanner is stored on the Setup Disc as an electronic manual in PDF format.
- If you are using Windows, the User Manual (electronic manual) will be registered to the following location when the software is installed.

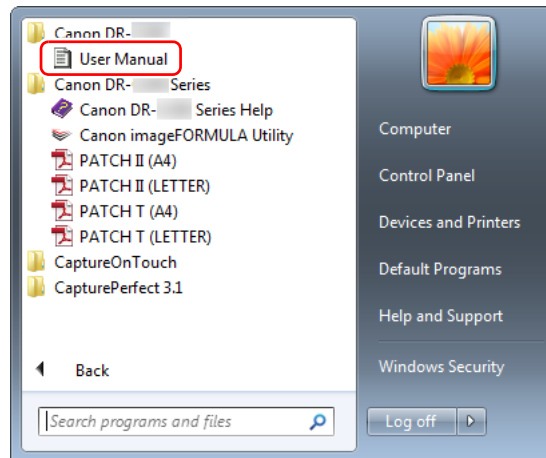

Hint

In Windows 8.1, it is registered at the following location.

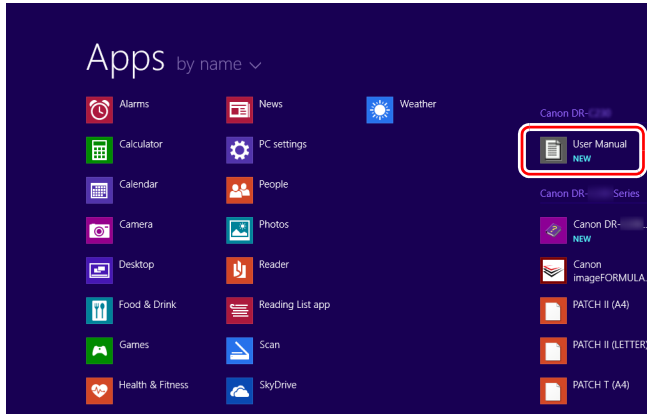

Symbols Used in This Manual

The following symbols are used in this manual to explain procedures, restrictions, handling precautions, and instructions that should be observed for safety. Indicates a warning concerning operations that may lead to death or injury to persons if not performed correctly.

WARNING

Indicates a caution concerning operations that may lead to injury to persons, or damage to property if not performed correctly. To use the scanner safely, always pay attention to these cautions.

CAUTION

Indicates operational requirements and restrictions. Be sure to read these items carefully to operate the scanner correctly, and avoid damaging the scanner.

IMPORTANT

Indicates a clarification of an operation, or contains additional explanations for a procedure. Please read carefully to avoid machine breakdowns and damage.

Hint

Indicates a reference for operation or supplementary explanation. Reading these notes is highly recommended.

Table of Contents

Setup Guide	5	Assigning a Function to the Function Key	58
Interface Connector Locations	11	User Mode Operations	60
Power Supply Connection	11	About User Mode.....	60
Connecting to a Computer	12	User Mode Operating Procedure	60
Turning Off the Power	14	Configuring Scanner Driver Settings	62
Introduction	15	User Mode Functions.....	65
Symbols Used in This Manual.....	16	Separation Off	65
Before Using the Scanner.....	19	New File	65
Important Safety Instructions	19	Scanner Setting.....	65
Installation Location	19	Scan Setting.....	66
Power Supply	20	Count Only	68
Moving the Scanner	20	Count Clear	69
Handling	20	Imprint Test	69
Disposal	22	Maintenance.....	70
Features of the Scanner	23	Network	71
Names and Functions of Parts	28	Scanning Methods	73
Basic Operation	34	Selecting a Scan Job	73
Documents	34	About the Job Function	73
Document Feed and Eject Tray Preparation	36	Scanning with CaptureOnTouch.....	75
Preparing the Document Feed Tray.....	36	What is CaptureOnTouch?.....	75
Adjusting the Document Guides.....	39	Setting the Scanner Driver	76
Preparing the Document Eject Tray	42	Configuration and Functions of the Scanner Driver	76
Document Feeding Methods.....	44	Setting Basic Scanning Conditions	79
Selecting the Document Feeding Method	44	More Advanced Scanning Methods (Batch	
Scanning Documents Larger than A3	47	Separation).....	92
Scanning with Carrier Sheets.....	49	Batch Separation (Insert blank page).....	92
Long Document Scanning.....	50	Batch Separation Using Patch Code Sheets.....	93
Detecting a Document Double Feed	53	About the Canon imageFORMULA Driver	
Count the Number of Document Sheets	56	Setting Tool.....	96

What is Canon imageFORMULA Driver Setting Tool?	96	Attaching the Separation Pad (Retard Roller Cover)	121
Start-up of the Canon imageFORMULA Driver Setting Tool	97	Imprinter Ink Cartridge Replacement and Cleaning	122
Web Menu	98	About the Imprinter	122
Using the Web Menu	98	Replacing Ink Cartridges	122
Displaying the Scanner's Web Menu	98	Specifying the Printing Position	125
Web Menu Pages	100	Cleaning the Imprinter	126
Web Menu Settings	101	Imprinter Testing	127
Scanner Name Setting	101	Head Cleaning	128
Network Setting	101	Troubleshooting	129
mDNS Setting	102	Common Problems and Solutions	129
Password Setting	103	Software Troubleshooting	134
Maintenance Setting	103	Useful tips	135
Maintenance	105	Paper Jam, Skew and Staple Detection Processing	137
Daily Maintenance	105	Error Message	138
Cleaning the Scanner	105	Uninstalling the Software	140
Cleaning the Sensors	106	Appendix	141
Opening and Closing the Upper Unit	106	Specifications	141
Cleaning the Scanning Glass, Roller, and Pad	107	Options	143
Adjusting the Compression	109	Consumables	143
Auto Power OFF Function	109	Dimensions	144
Power Plug	109	Other Specifications	145
Replacing the Feed Roller	110	Imprinter Specifications	145
Roller Replacement Cycle	110	Index	146
Checking and Resetting the Page Counter	111		
Removing and Reinstalling the Rollers	113		
Detaching and attaching the separation pad (retard roller cover)	120		
When to Replace the Separation Pad (Retard Roller Cover)	120		
Detaching the Separation Pad (Retard Roller Cover)	120		

Before Using the Scanner

Important Safety Instructions

To ensure the safe operation of this scanner, be sure to read the safety warnings and precautions described below.

Installation Location

The performance of this scanner is affected by the environment in which it is installed. Make sure that the location where the scanner is installed meets the following environmental requirements.

- Provide adequate space around the scanner for operation, maintenance, and ventilation.

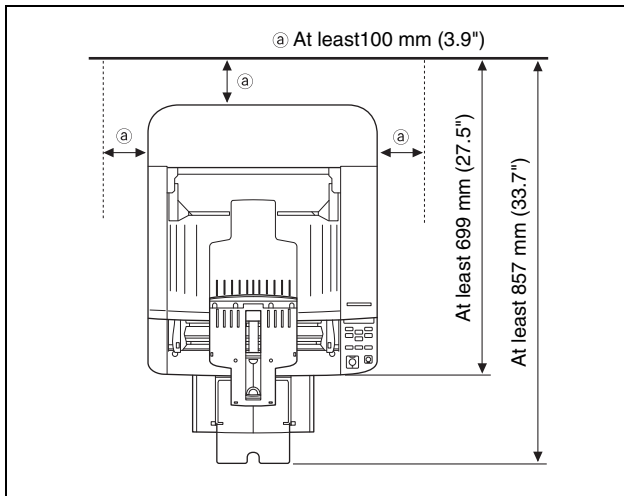

- Avoid installing the machine in direct sunlight. If this is unavoidable, use curtains to shade the scanner.
- Avoid locations where a considerable amount of dust accumulates as dust may adversely affect the inside of the scanner. Avoid warm or humid locations, such as in the vicinity of a water faucet, water heater, or humidifier.
- Avoid locations where ammonia gas is emitted. Avoid locations near volatile or flammable materials, such as alcohol or paint thinner.
- Avoid locations that are subject to vibration.
- Avoid exposing the scanner to rapid changes in temperature. If the room in which the scanner is installed is cold but rapidly heated, water droplets (condensation) may form inside the scanner. This may result in a noticeable degradation in scanning quality. The following conditions are recommended for optimal scanning quality:
Room temperature: 10 °C to 35 °C (50 °F to 95 °F)
Humidity: 20% to 80% RH
- Avoid installing the scanner near equipment that generates a magnetic field (e.g. speakers, televisions, or radios.)

Power Supply

- Connect only to a power outlet of the rated voltage and power supply frequency (120 V, 60 Hz or 220-240 V, 50/60 Hz depending on your region).
- Do not use the scanner with a power supply that is not rated for the specified voltage. Doing so might cause a fire or electric shock.
- Do not connect other electrical equipment to the same power outlet to which the scanner is connected. Also, when using an extension cord, make sure that the extension cord is rated for the current requirements of the scanner.
- The power cord may be damaged if frequently stepped on or if heavy objects are placed on it.
- Do not use the power cord while it is coiled.
- Do not pull directly on the power cord. When disconnecting the power cord, grasp the plug and remove it from the outlet.
- Keep the area around the power cord clear of objects so that the power cord can be disconnected easily in an emergency.
- If you have any questions regarding the power supply, contact your local authorized Canon dealer or service representative for further information.

Moving the Scanner

- The scanner weighs about 25.0 kg (55.1 lbs). To lift or move the scanner, always use two people, one on each side. Never attempt to lift the scanner by yourself. You could drop the scanner or pinch your fingers, resulting in personal injury or damage to the scanner. Remember to be extra careful when moving it.

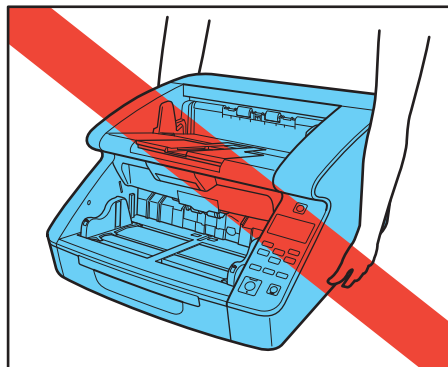

- Make sure to disconnect the interface cable and power cord when moving the scanner. If the scanner is carried with these items connected, the plugs and connectors may be damaged or cause the scanner to fall and result in personal injury or damage to the scanner.

Handling

WARNING

Note the following precautions whenever using the scanner. Failure to do so may result in a fire or electric shock.

- Never use alcohol, benzene, paint thinner, aerosol sprays, or any other highly flammable substance near the scanner.
- Do not cut, damage, or modify the power cord. Do not place heavy objects on the power cord, and do not pull or excessively bend the power cord.

-
- Never connect the power cord when your hands are wet.
 - Do not connect the scanner to a multi plug power strip.
 - Do not knot or coil the power cord as this may result in a fire or electric shock. When connecting the power cord, make sure that the power plug is securely and completely inserted into the power outlet.
 - To use a reel-type extension cord, unwind all of the cord from the reel. Long-term operation with the cord wound on the reel may cause the cord to overheat and could cause a fire.
 - Do not use power cords other than the power cord supplied with this scanner.
 - Never try to take the scanner apart or modify it in any way, as this is dangerous and may lead to a fire or electric shock.
 - Do not use flammable spray near the scanner.
 - When cleaning the scanner, turn the power switch OFF and disconnect the power plug from the power supply.
 - Clean the scanner using a slightly dampened cloth which has been well wrung out. Never use alcohol, benzene, paint thinner, or any other flammable substances.
 - If an abnormal sound, smoke, heating, or an unusual odor occurs, or when an abnormality is discovered such as the scanner not working after turning the power OFF and back ON, immediately turn off the power switch and unplug the power plug from the outlet. Then, contact your local authorized Canon dealer or service representative to have the unit serviced.
 - Do not drop the scanner, or subject it to impact or strong shock. Should the scanner ever become damaged, immediately turn the power switch OFF, and disconnect the power plug from the power outlet. Then, contact your local authorized Canon dealer or service representative to have the unit serviced.

- Before moving the scanner, make sure to turn the power switch OFF, and disconnect the power plug from the power outlet.

 **CAUTION**

- Do not install the scanner on a surface that is unstable or tilted, or in an area subject to excessive vibrations, as this may cause the scanner to fall, resulting in personal injury or damage to the scanner.
- Do not block the ventilation holes. Doing so could cause the scanner to overheat, creating a fire hazard.
- Never place small metal objects such as staples, paper clips, or jewelry on the scanner. These items may fall into the scanner, and cause a fire or electric shock. Should such objects ever fall inside the scanner, immediately turn the power switch OFF, and disconnect the power plug from the power outlet. Then, contact your local authorized Canon dealer or service representative to have the unit serviced.
- Do not install the scanner in a humid or dusty location. Doing so might cause a fire or electric shock.
- Do not place objects on top of the scanner. Such objects may tip or fall over, resulting in personal injury.
- When unplugging the power cord, grasp it firmly by its plug. Do not pull directly on the power cord, as this may damage or expose the cord's internal wiring, resulting in a fire or electric shock.
- Leave sufficient space around the power plug so that it can be unplugged easily. If objects are placed around the power plug, you will be unable to unplug it in an emergency.
- Do not allow water or flammable substances (alcohol, paint thinner, benzene, etc.) to spill into the scanner, as this may result in a fire or electric shock. Doing so might cause a fire or electric shock.

-
- For safety when the scanner will not be used for a long time, be sure to unplug the power cord from the scanner and unplug the power plug from the wall outlet.
 - Do not wear loose clothing or jewelry that may get caught in the scanner while you are using it, as this may result in personal injury. Be extra careful of neckties and long hair. If anything becomes caught in the scanner, immediately disconnect the power cord to stop the scanner.
 - Be careful when loading paper into the scanner and when removing jammed paper, as it is possible to cut your hand on the edge of a sheet of paper.



CAUTION: Hot Surface

- The part where the seal is attached can become hot, and handling it carelessly can result in burns. To ensure safe handling, be sure to observe all safety precautions.

Disposal

When disposing of the scanner, be sure to follow all local ordinances and laws, or consult with your local authorized Canon dealer or service representative.

Features of the Scanner

The main features of the scanner are described below.

Scanner Features

- **Variety of Scanning Modes**

The scanner is equipped with the following scanning modes. Black and White, Error Diffusion, Advanced Text Enhancement, Advanced Text Enhancement II, Active Threshold, 256-level Grayscale, and 24-bit Color

* Advanced Text Enhancement and Active Threshold can clarify scanned text by processing background or foreground colors.

- **Fast Document Feeding**

The scanner can scan up to 140 document sheets per minute of LTR/A4-size paper in black and white, grayscale, and color scanning modes (for the DR-G2140).

* Scanning conditions: LTR/A4 landscape, duplex, 300 dpi

- **Large Capacity Feeder**

Up to 500 plain paper document sheets (up to 300 in the DR-G2090) can be loaded in the Document Feed Tray.

- **Count-Only Mode**

When operating the scanner as a stand-alone device, this mode counts the number of loaded document sheets. "[Count-Only Mode](#)" (See p. 56)

- **Adjustable Document Feed Tray**

The position of the Document Feed Tray can be adjusted according to the number of document sheets to be loaded. "[Preparing the Document Feed Tray](#)" (See p. 36)

- **Long Document Mode**

Depending on User Mode settings, it is possible to scan documents up to 5,588 mm long (220") (or up to 3,000 mm (118.11") with the DR-G2090). Also, the feeding speed can be changed in Long Document Mode. "[Long Document Scanning](#)" (See p. 50)

- **Freely Adjustable Document Guides**

The left and right document guides can be adjusted for either left- or right-side scanning. "[Adjusting the Document Guides](#)" (See p. 39)

- **User Mode**

User Mode functions can be employed to set the scanner for practically any condition. "[User Mode Operations](#)" (See p. 60)

Detection Functions

● Auto Color Detection

Automatically detects whether scanned documents are color, grayscale, or black and white.

● Paper Size Detection

Detects the document page size before scanning.

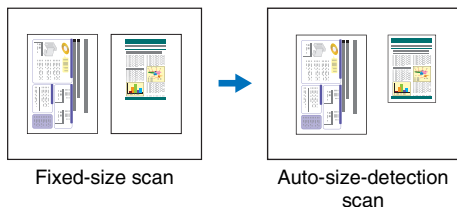

● Skew Detection

The scanner stops feeding when a skewed document is detected as it touches the edges of the feeder inlet.

● Staple Detection

The scanner stops feeding when it detects the presence of stapled documents. "Staple Detection" (See p. 67)

● Dust Detection

Detects dust in the scanning unit and performs error processing as needed. "Dust Detection" (See p. 68)

● Ultrasonic Double Feed Detection

The scanner stops feeding when the ultrasonic sensor detects that two or more document pages are feeding at the same time. "Double Feed" (See p. 66)

* A non-detection area can be specified to avoid double-feed detection in areas such as those containing adhesive labels.

● Double feed detection by length

The scanner stops feeding when a double feed is detected by comparing document page lengths. "Double Feed" (See p. 66)
* Based on the length of the first document page, the scanner detects a double feed when fed a different-length page.

● Prescan

At the start of scanning, this function prescans the first page and pauses so that you can adjust brightness and contrast before resuming scanning.

● Verify Scan

While scanning, the scanned page count is verified against a pre-specified count or that obtained from Count-Only Mode. "Verify Scan" (See p. 56)

● Text Orientation Detection

The text orientation on each page is detected, and the scanned image is rotated in 90-degree increments as necessary for normalization.

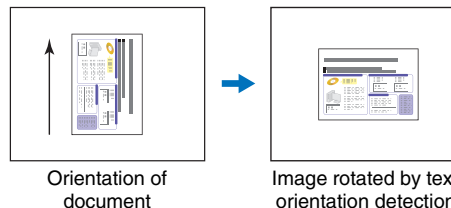

Image Processing

● Prevent Bleed Through/Remove Background

Prevents the background or original image on the reverse side of thin originals from appearing in scanned images.

- **Color Unevenness Reduction Function**

You can control or reduce the color irregularity at the time of the scan.

- **Document orientation**

The text orientation on each fed page is detected, and the scanned image is rotated in 90-degree increments as necessary to match.

- **Deskew**

If a scanned image is detected to be skewed, the skewed image is straightened.

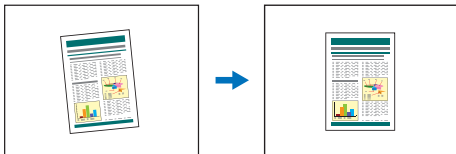

Skewed image

Deskewed image

- **Drop-Out and Color Enhancement**

The scanner is equipped with color drop-out and enhancement functions that enable you to specify one color (red, blue, or green) or intermediate color range to be omitted (dropped out) or enhanced when scanning.

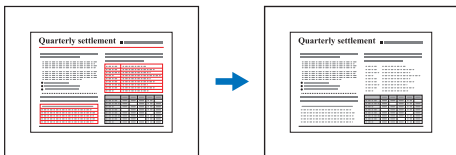

Multicolor original

Red dropped out

- **Binding Hole Removal**

Erases shadows that appear on scanned images from binding holes on the document.

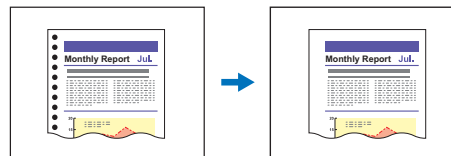
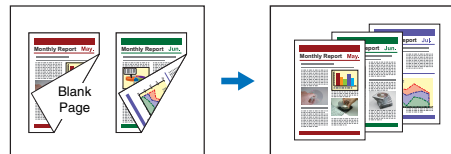

Image with binder holes

Image with binder holes removed

- **Skip Blank Page**

The scanner scans both sides of each page and skips saving images of pages detected to be blank.



Two-sided documents with blank page

Skipped blank page

● Folio Scan

Documents that are too large to fit in the feeder inlet can be folded and scanned on both sides, with the images then combined into a single image. "[Scanning Documents Larger than A3](#)" (See p. 47)

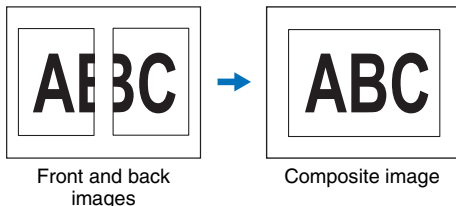

● MultiStream

With applications that support the scanner's MultiStream capability, three images with different scanning conditions are created from a single scan pass. However, this function is only available when using software that supports MultiStream.

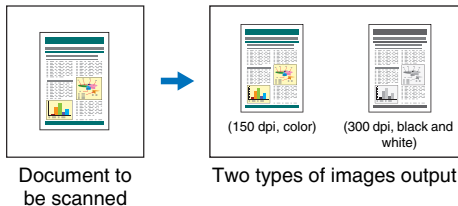

● Thickening Text and Lines

If text and lines in scanned images are very thin, this function corrects for their thickness while scanning.

● Background smoothing

Processes scanned images to smooth the background. It can be used when [Detect automatically], [256-level Gray], or [24-bit Color] is selected for [Color Mode] on the [Basic] tab sheet.

● Barcode Detection

Barcodes on documents can be detected and decoded by installing the barcode module.

● Patchcode Detection

Patchcode sheets can be inserted in the document stack to perform batch separation. "[More Advanced Scanning Methods \(Batch Separation\)](#)" (See p. 92)

Other requirements

● Rapid Recovery System

When this function is activated and a sensor detects a misfeed, such as from a paper jam or double feed, scanning pauses to allow you to correct the cause before continuing from the document page on which the abnormality was detected. "[Detecting a Document Double Feed](#)" (See p. 53)

* The Rapid Recovery System is effective when feeding stops as a result of detection of a Paper Jam, Double Feed, Skew, or Staple.

● A4 Carrier sheet

Use the separately sold carrier sheet (A4), you can scan without damaging the original.

● Feed Interval Setting

You can set the document feed interval. Lengthening the paper feed interval can make it easier to keep ejected documents aligned.

Option

- **Imprinter**

Use to print on scanned documents.

Names and Functions of Parts

Front View

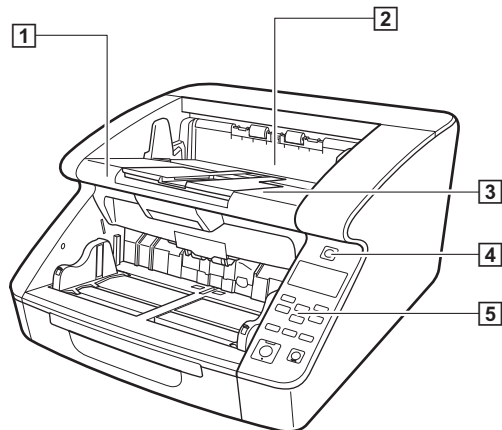

1 Upper Unit

Open when cleaning the rollers or clearing paper jams. (See p. 106)

2 Imprinter Cover

Open when replacing the ink cartridge for the optional imprinter or when cleaning the imprinter. (See p. 122)

3 Document Eject Tray

Scanned documents are output here. (See p. 42)

4 Power Switch

Turns the scanner on and off. (See p. 13)

5 Operation Panel

(See p. 30)

⚠ CAUTION

Do not open the imprinter cover if the optional imprinter is not installed.

Front View (with Document Feed and Eject Trays extended)

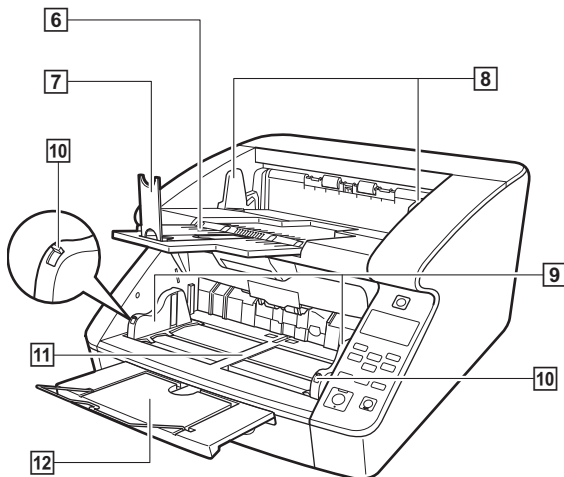

6 Document Eject Tray Extension

Open the Document Eject Tray Extension to prevent documents from falling off of the Document Eject Tray. (See p. 42)

7 Document Eject Stopper

Adjust to fit the length of documents, to avoid document spillage. (See p. 43)

8 Document Eject Guides

Adjust to fit the width of documents, so that ejected documents stack neatly. (See p. 42)

9 Document Feed Guides

Adjust to fit the width of documents. (See p. 38, p. 39)

10 Document Guide Lock Levers

Locks the Document Guides. (See p. 39)

11 Document Feed Tray

Load documents to be scanned here. (See p. 36)

12 Document Feed Tray Extension / Wire

Extend as needed to fit the length of the documents. (See p. 39)

Back View

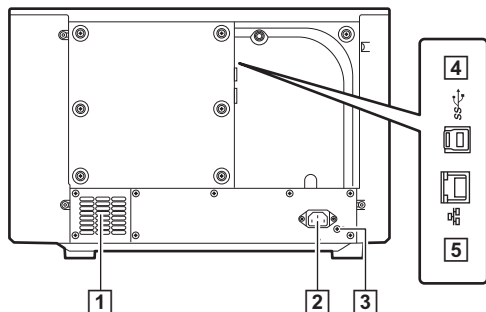

1 Ventilation Holes (Exhaust Fan)

Exhausts heat from inside the scanner.

2 Power Connector

Connect the supplied power cord here. (See p. 11)

3 USB Connector (Type B)

Connect the supplied USB cable here. (See p. 12)

4 LAN Connector (RJ-45)

Connect a network cable that supports RJ-45 (10Base-T, 100Base-TX, 1000Base-T) here. (See p. 12)

⚠ CAUTION

Do not block the ventilation holes. Doing so could cause the scanner to overheat, creating a fire hazard.

Operation Panel

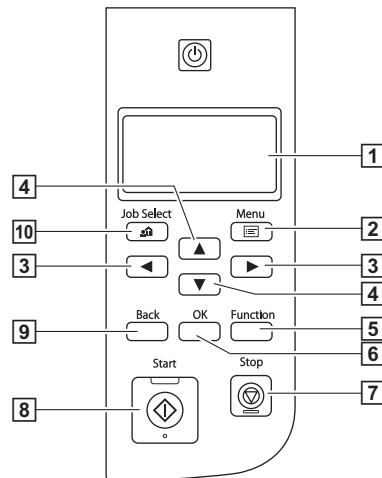

1 Display Panel

Displays the user mode, job info, messages, and counter.

2 Menu Key

Displays the user mode. (See p. 60)

3 ◀▶ Keys

Selects the features such as user mode and jobs.

4 ▲▼ Keys

Selects the features such as user mode and jobs.

5 Function Key

Executes the assigned function. (See p. 58)

6 OK Key

Selects the user mode, and accepts settings.

7 Stop Key

Stops a scan in progress.

8 Start Key

Starts scanning.

9 Back Key

Returns to the previous display panel screen.

10 Job Key

Selects jobs. (See p. 73)

Display panel examples

The information displayed on the display panel changes depending on the status of the scanner.

The following are representative examples.

● Information displayed on the screen

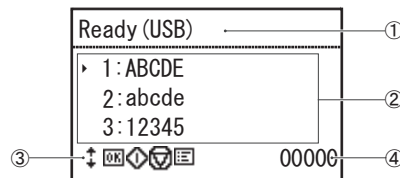

① Title area

Shows the scanner's connection mode.

When USB is connected, "(USB)" is displayed after the title. When the scanner and computer are connected via a network, "(LAN)" is displayed. However, neither "(USB)" nor "(LAN)" is displayed on USB-only models.

② Comments area

Displays available menu and job items, error messages, etc.

③ Operation buttons area

Icons that control scanning operations and indicate setting states are displayed.

The icons displayed are as follows.

: Separation Mode setting





: New File setting

Keys

Keys

(OK) Key

(Start) Key

-  (Stop) Key
-  (Menu) Key
-  (Job) Key
-  (Back) Key
-  (Function) Key

④ Display count area

Displays the number of documents that have been scanned.

● Jobs Screen

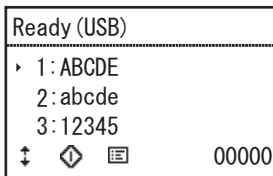

The Jobs Screen will be displayed after turning the power ON. A maximum of 99 registered jobs can be displayed on this screen. "ABCDE", "abcde", and "12345" are the examples of registered job names. Select a job using the ▲▼ keys, and press the Start key to execute.

● Menu Screen

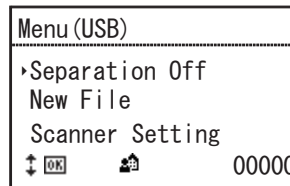

When the Jobs screen is displayed, pressing the Menu key displays the Menu screen.

Press the Job key when the Menu screen is displayed to return to the Jobs screen.

Press the ▲▼ keys to select a menu item, and press the OK key to accept the selected item.

The following are items that can be selected/executed from the display panel.

Items displayed on the [Menu] screen.	Description
Separation Off	The scanner becomes the manual feeding mode (non-continuous).
New File	Enables the file separator function.
Scanner Setting	Displays scanner setting items.
Scan Setting	Displays scan setting items.
Count Only	Displays the Count Only setting screen for executing Count-Only mode.
Count Clear	Resets the count in the display's count area (bottom right on the display).

Items displayed on the [Menu] screen.	Description
Imprint Test	Displays the Imprinter Test screen for executing an Imprinter Test.
Maintenance	Displays various information about the scanner.
Network	Confirm or change the network settings.

● **Message screen**

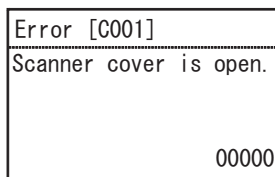

Displays the status of the scanner.

While scanning, information related to feeding is displayed.

When an error occurs, error code, and error details are displayed.

● **About the Function Key**

The following functions can be assigned to the Function key with the Canon imageFORMULA Driver Setting Tool. ["Assigning a Function to the Function Key"](#) (See p. 58)

- Counter clear
- Count Only
- Manual Feeding
- Batch Separation

The scanner's factory default Function key assignment is "Count Clear".

Documents

This scanner can scan documents ranging in size from business cards and checks up to A3 size, and documents of the following sizes and paper thicknesses can be used depending on the paper feed method.

Size

Width:

50.8 to 305 mm (2" to 12.01")

Length:

70 to 432 mm (2.76" to 17.01")

(when Long Document Mode is [Standard (432 mm)])

70 to 1,000 mm (2.76" to 39.37")

(when Long Document Mode is [Long Document (1000 mm)])

70 to 3,000 mm (2.76" to 118.11")

(when Long Document Mode is [Long Document (3000 mm)])

70 to 5,588 mm (2.76" to 220")

(when Long Document Mode is [Long Document (5588 mm)])



Hint

- Setting the scanner to Long Document Mode enables scanning documents up to 5,588 mm (220") long. ["Long Document Scanning"](#) (See p. 50)
- The [Long Document (5588 mm)] setting is not available in the DR-G2090.

Paper thickness

Continuous Feeding:

20 g/m² to 209 g/m² (5 to 56 lb bond) (0.04 mm to 0.25 mm)

Manual Feeding:

20 g/m² to 255g/m²(5 lb to 64 lb bond) (0.04 mm to 0.3 mm)



Hint

Continuous feeding feeds document pages from the Document Feed Tray one by one by the feed and retard rollers until the batch of documents has been scanned.



IMPORTANT

The documents to be scanned must satisfy certain criteria. Read the following items carefully.

- When scanning multiple pages, they must be grouped together so that they have the same size, thickness, and weight. Scanning different types of paper at one time may cause paper jams.
- Scanning documents before the ink is dry can cause problems with the scanner. Always make sure that the ink on a document is dry before scanning it.
- Scanning documents that are written in pencil or similar material may make the rollers and scanning glass dirty, which can lead to smudges on the scanned image and transfer the dirt to subsequent documents. Always clean the internal parts of the scanner after scanning such documents.
- When scanning a two-sided document that is printed on thin paper, the image on the opposite side of each page may show through. In that case, adjust the scanning brightness from the application program, or enable the [Prevent Bleed Through/Remove Background] setting before scanning.

- Scanning the following types of documents can cause a paper jam or malfunction. To scan such a document, make a photocopy of the document and then scan the photocopy.



There are creases or fold lines.



Carbon paper.



There are curls.



The surface is coated.



There are tears.



Extremely thin document such as semi-transparent thin paper.



There are clips or staples.



Documents with excessive paper dust particles.

- To scan bound multi-page documents such as invoice booklets, place the bound edge against the feeder inlet and scan by manual feeding.
- To use the Long Document Mode, feed document pages manually, one after another.
- In Folio document mode, fold sheets and feed them manually, one side at a time.

Document Feeder Capacity

Maximum of 500 sheets (80g/m²)

Sizes Larger than A4: Maximum of 200 sheets (80 g/m²)

Maximum loading height: 48 mm (1.89")



IMPORTANT

Do not exceed the load limitation mark when placing documents in the Document Feed Tray. It may cause paper jams.

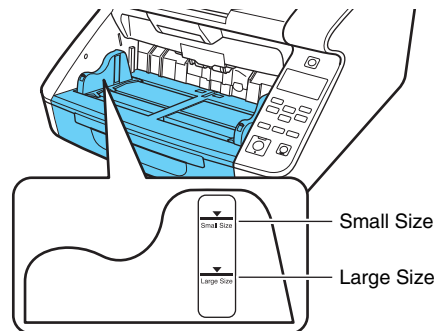

Small Size Limitation Mark: When loading documents smaller than LTR/A4 size.

Large Size Limitation Mark: When loading documents larger than LTR/A4 size.

Document Feed and Eject Tray Preparation

Before scanning, prepare the Document Feed and Eject Trays for the desired paper size.

Preparing the Document Feed Tray

Document Feed Tray

The height of the Document Feed Tray can be adjusted according to the number of document pages to be loaded (the default setting is the lowest position).

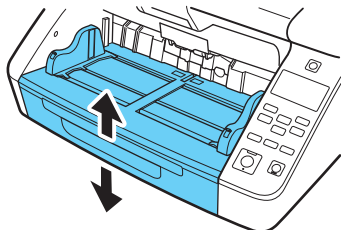

The proper height of the Document Feed Tray can be set with the scanner driver or by the User Mode's [Tray position] setting. This minimizes the time required to start feeding documents loaded on the Document Feed Tray.

Setting with the Scanner Driver

By default, the height of the Document Feed Tray is set by the scanner driver.

- 1 Open the scanner driver's setting screen. (See p. 76)
- 2 On the [Feeding] tab sheet, click the [Advanced setting] button.

The [Advanced feed setting] dialog box opens.

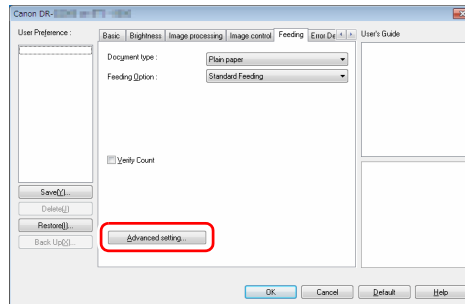

3 Select the [Tray position] according to the number of documents to be loaded.

[500 sheets]: to load up to 500 sheets

[300 sheets]: to load up to 300 sheets

[100 sheets]: to load up to 100 sheets

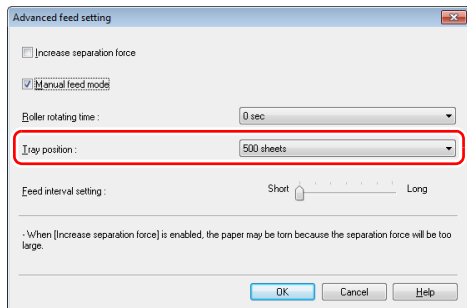

Hint

The [500 sheets] setting is not available in the DR-G2090.

4 Click the [OK] button to close the settings screen.

The Document Feed Tray moves to the setting height.

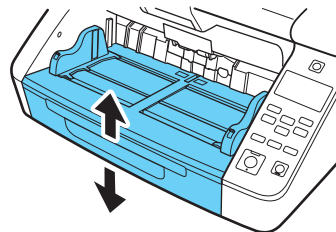

Setting by User Mode

This procedure sets the height of the Document Feed Tray by the User Mode.

To make this setting in the User Mode, first allow it by the Canon imageFORMULA Driver Setting Tool. "[Configuring Scanner Driver Settings](#)" (See p. 62)

1 Press the Menu key on the operation panel.

User Mode is activated. "[User Mode Operations](#)" (See p. 60)

2 Press the ▲▼ keys to select [Scan Setting], and press [OK].

The scan setting items are displayed.

3 Press the ▲▼ keys to select [Tray position], and press [OK].

The tray position setting items are displayed.

4 Check the setting.

[500]: to load up to 500 sheets

[300]: to load up to 300 sheets

[100]: to load up to 100 sheets



Hint

The [500] setting is not available in the DR-G2090.

5 Press the ▲▼ keys to select, and press [OK] to accept.

The Document Feed Tray moves to the selected height.

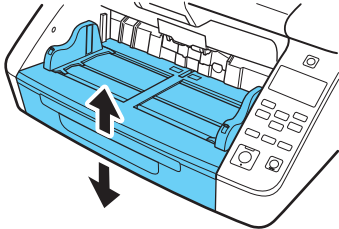

6 Press the Menu key to return to the original screen.

Document Guides

Slide the document guides to match the document width.

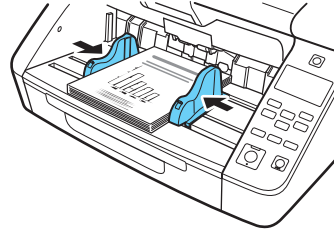

Hint

The positions of the left and right document guides can be locked independently for off-center loading. For details, see ["Adjusting the Document Guides" on p. 39](#).

Document Feed Tray Extension/Wire

Extend as needed to fit the document length.

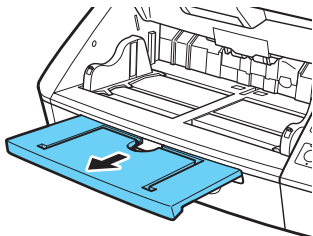

Gently open the extension wire.

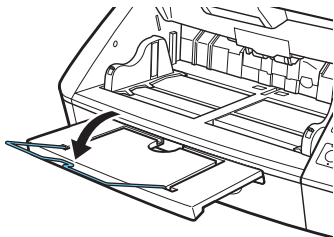

Hint

Use the extension wire if the document length exceeds that of the Document Feed Tray Extension.

Adjusting the Document Guides

The document guides normally extend the same distance left and right from the center of the feed tray, so that documents are centered at the feeder inlet.

However, each document guide has a lock lever, so you can position documents nearer the left or right side of the feeder inlet by locking the document guides at the appropriate positions.

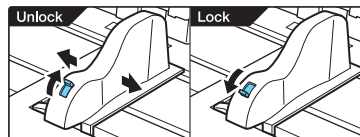

Loading Documents at the Left Side

This procedure shows how to load documents at the left side of the feeder.

- 1** Spread the document guides all the way to the left and right.

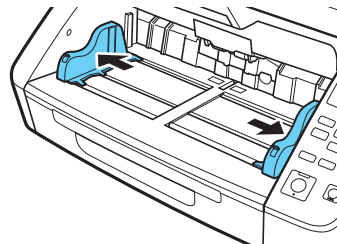

2 Place the document.

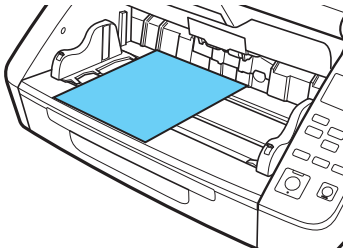

3 Lock the left document guide (1), then slide the right document guide to the right edge of your documents (2).

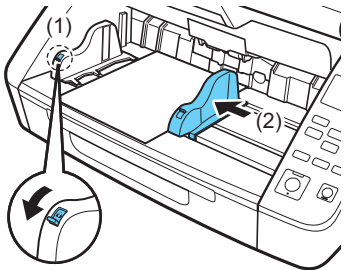

4 Lock the right document guide (1), and unlock the left document guide (2).

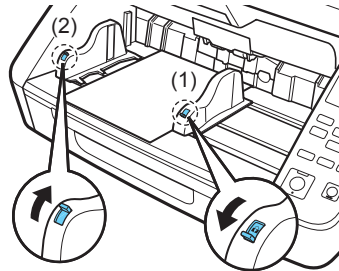

5 Slide the left document guide to the left edge of your documents.

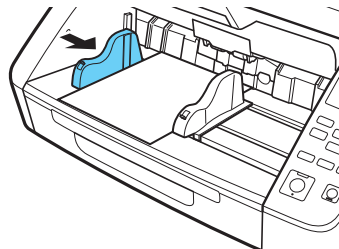

Resetting the Document Guides

To reset the guides so that they are equidistant from the center, perform the following procedure to spread the guides to the left and right as far as they can go.

- 1** Confirm that the right document guide is locked (1), and slide the left guide all the way to the left (2).

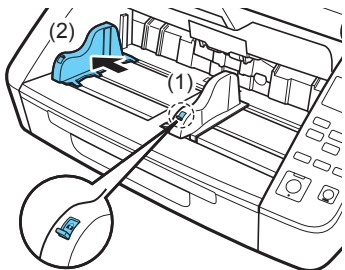

- 2** Lock the left document guide (1), and unlock the right document guide (2).

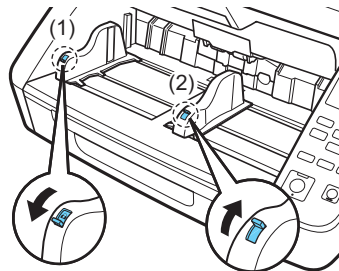

- 3** Slide the right document guide all the way to the right.

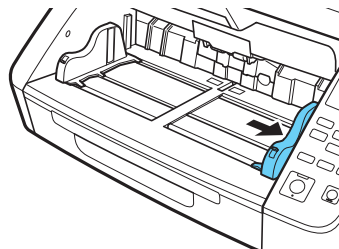

4 Unlock the left document guide.

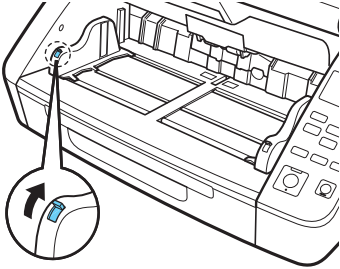

Preparing the Document Eject Tray

The Document Eject Tray includes two Document Eject Guides, the Eject Tray Extension and Eject Paper Stopper, to be adjusted to fit the width and length of your documents.

Document Guides

Slide the Document Eject Guides to fit the width of your documents. The eject position of the document can be checked by feeding a single document sheet in Count-Only Mode. "[Count-Only Mode](#)" (See p. 56)

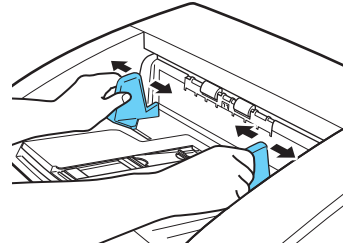

Document Eject Tray Extension

Open the Document Eject Tray Extension when documents may eject beyond the Document Eject Tray.

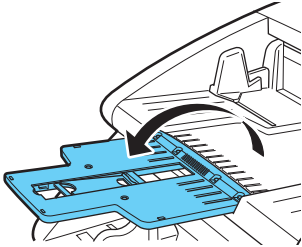

When LTR/A4-size documents are loaded, close the Document Eject Tray Extension and raise the Document Eject Stopper. When A3-size documents are loaded, open the Document Eject Tray Extension and raise the Document Eject Stopper.

Document Eject Stopper

Raise the Document Eject Stopper to stop ejected documents from spilling out of the Document Eject Tray.

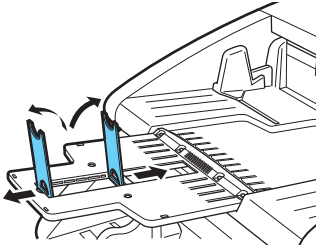

Hint

The Document Eject Stopper is attached to the Document Eject Tray Extension, so you can adjust its position to suit the document length.

Document Feeding Methods

Two document feeding methods are available: continuous feeding, which feeds documents automatically from the Document Feed Tray by the pickup roller; and manual feeding, which requires manually feeding one document at a time for transport by the feed roller, while the pickup roller is disabled.

Selecting the Document Feeding Method

Continuous Feeding is the default feeding method. However, for the one-by-one page feeding, manual feeding can be enabled by selecting [Manual Feeding] as the [Feeding Option] in the ISIS/TWAIN driver, or [Separation Off] with the User Mode. Continuous manual feeding is also provided as way to scan a batch of document pages that cannot be automatically fed.

Continuous Feeding

With Continuous Feeding, documents loaded in the Document Feed Tray are picked up automatically by the pickup roller and transported by the feed roller, while the retard roller separates each page to avoid double feeding

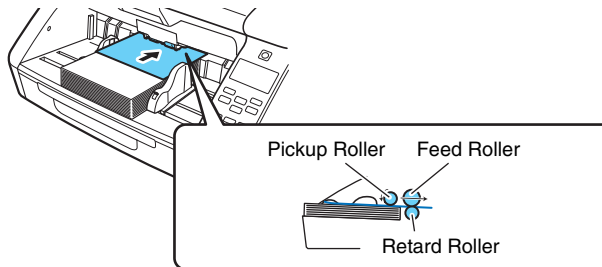

Manual Feeding

The Document Feed Tray is raised so that documents can be fed manually one sheet at a time.

For manual feeding, you need to insert each document page far enough to be pulled in by the feed roller (because the pickup roller is disabled).



! IMPORTANT

- Because pages are not separated by the retard roller during manual feeding, a paper jam will occur if multiple pages are fed together.
- To scan bound multi-page documents such as invoice booklets, place the bound edge against the feed inlet and scan using manual feeding.

💡 Hint

- In the manual feed mode, the  icon is displayed on the display panel.
- The User Mode's [Separation Off] setting corresponds to the [Manual Feeding] Feeding Option setting in the ISIS/TWAIN driver. Enabling the [Separation Off] with User Mode or selecting the [Manual Feeding] feeding option causes the Document Feed Tray to rise.
- By assigning "Manual Feeding" to the Function key, it can be enabled and disabled by pressing the key. ["Assigning a Function to the Function Key"](#) (See p. 58)

Continuous manual feeding mode

Enable the Continuous Manual Feeding Mode from the User Mode when document pages do not separate properly using Continuous Feeding.

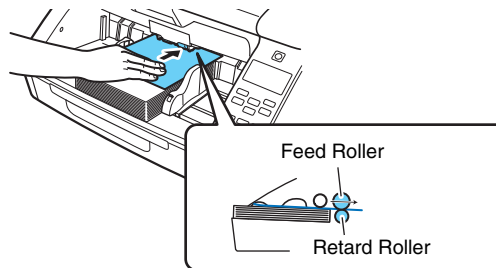

💡 Hint

For the ordinary manual feeding are non-continuous, so that documents are placed beside the scanner to be picked up and handed one page at a time. For the continuous manual feeding mode, a stack of documents is placed on the Document Feed Tray and handed from there one page at a time, making operation easier.

The continuous manual feeding mode can be set with the scanner driver or by the selecting [Manual Feed] in User Mode.

! IMPORTANT

Be sure to turn off the continuous manual feeding mode after scanning. Otherwise, normal Continuous Feeding will be disabled the next time someone uses the scanner.

Setting with the Scanner Driver

By default, the continuous manual feeding mode have to be set by the scanner driver.

1 Open the scanner driver's setting screen. (See p. 76)

2 On the [Feeding] tab sheet, click the [Advanced setting] button.

The [Advanced feed setting] dialog box opens.

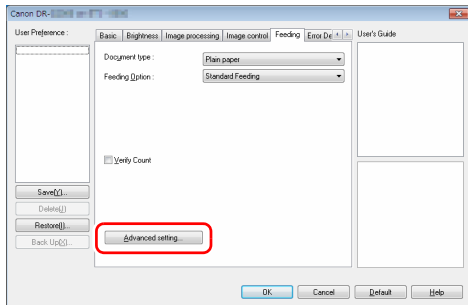

3 Select the [Manual feed mode] check box.

With selected: Disables the Pickup Roller so that loaded documents have to be hand fed for transport by the Feed Roller one page at a time.

Not selected: Documents are fed continuously by the Pickup Roller unless the manual feeding mode (separation off) is enabled.

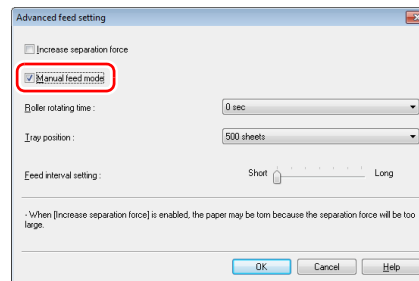

4 Click the [OK] button to close the settings screen.

Setting with User Mode

The continuous manual feeding mode can be enabled and disabled in the User Mode.

To make this setting in the User Mode, first allow it by the Canon imageFORMULA Driver Setting Tool. "[Configuring Scanner Driver Settings](#)" (See p. 62)

- 1 Press the Menu key on the operation panel.**
User Mode is activated. "[User Mode Operations](#)" (See p. 60)
- 2 Press the ▲▼ keys to select [Scan Setting], and press [OK].**
The scan setting items are displayed.
- 3 Press the ▲▼ keys to select [Manual Feed], and press [OK].**
The continuous manual feed setting items are displayed.
- 4 Press the ▲▼ keys to select [On/Off], and press [OK].**
- 5 Confirm the settings.**
[On]: Disables the Pickup Roller so that loaded documents must be hand fed for transport by the Feed Roller one page at a time.
[Off]: Documents are fed continuously by the Pickup Roller unless the ordinary manual feeding mode is enabled.
- 6 Press the ▲▼ keys to select, and press [OK] to accept.**
- 7 Press the Menu key to return to the original screen.**

Scanning Documents Larger than A3

Folio Scan enables you to scan documents that are larger than A3 and therefore do not fit in the feeder. To use the function, fold the document in half lengthwise and place it into the feeder. The scanner will scan both sides and combine the scanned images into a single image.

- 1 Open the scanner driver's setting screen. (See p. 76)**
- 2 Set [Page Size] on the [Basic] tab to a size that is half that of the paper to be actually scanned, and set [Scanning Side] to [Folio]. For example, when scanning a document of A2 size folded, set [Page Size] to [A3].**

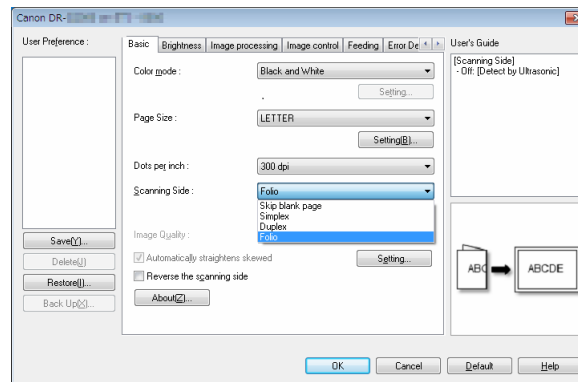

! IMPORTANT

When [Scanning Side] is set to [Folio], [Detect by Ultrasonic] in the [Error Detection] tab sheet – [Double Feed Detection] is automatically turned off.

3 Set [Feeding Option] on the [Feeding] tab to [Manual Feeding]. (See p. 44)

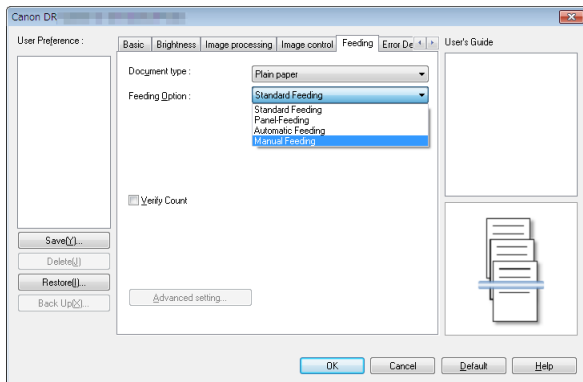

4 Click the [OK] button to close the settings screen.

5 Fold the document in half.

Crease the document firmly down its center to fold the document in half. Fold the document so that its edges are neatly aligned. If the document is not folded properly, paper jams may occur or distortions may appear in the combined scanned image.

! IMPORTANT

A portion of the scanned image will be missing at the fold line.

6 Place the document with the folded edge facing right.

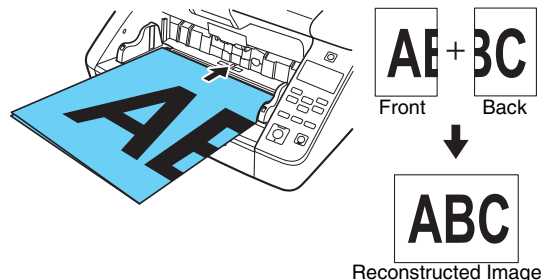

! IMPORTANT

Adjust the document guides to fit the width of the document. Otherwise, the image may scan as skewed or shifted.

💡 Hint

- The scanned image of the front side becomes the left half of the recombined image.
- The maximum size for combined images is A2. Use this method to scan A2-sized documents. When scanning a folded document of a size other than the standard formats, set [Page Size] on the scanner driver settings screen to [Match original size]. (See p. 80)

Scanning with Carrier Sheets

To scan without damaging documents or contaminating the rollers and feed path with documents such as carbon paper, insert each document sheet into an optional carrier sheet before loading it in the scanner.

- 1 Open the scanner driver's setting screen. (See p. 76)
- 2 Open the [Feeding] tab, and set [Document type] to [Carrier sheet].

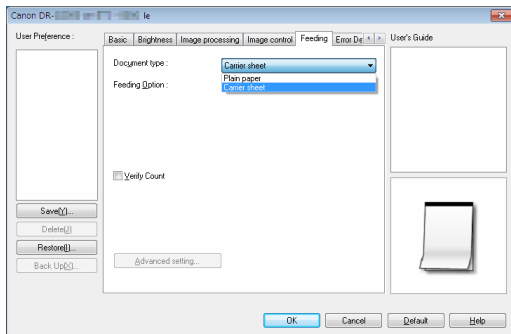

- 3 Click the [OK] button to close the settings screen.

- 4 Insert the document into the carrier sheet.
You can set up to three Carrier sheets at a time in the scanner.

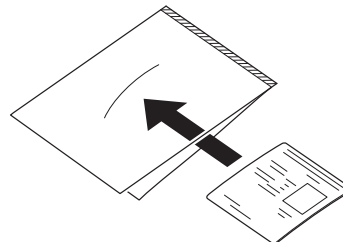

- 5 Load the document with the sealed end of the carrier sheet as the leading edge.

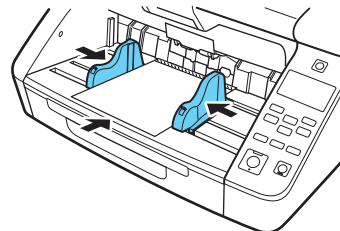

After placing the document, align the document guides with both edges of the document.

CAUTION

If the document is not placed properly inside the carrier sheet, you may get a document jam or not get a scan image as intended.

IMPORTANT

- Insert documents straight into the center of the carrier sheet. Proper scanning will not be possible if the document is too close to either side, tilted, or protruding from the carrier sheet.

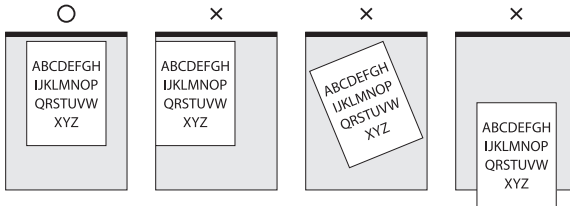

- The maximum thickness of documents that can be scanned in the carrier sheet is 127 g/m² (0.15 mm). Documents thicker than 127 g/m² may cause scanner malfunctions such as paper jams.
- Carrier sheet is a consumable item. Replace it with a new one when necessary, if there is visible damage or smudging.
- As a rough guide, replace the carrier sheet after 1,000 scanning operations with a single 80g/m² (22 lb bond) sheet inserted.

Long Document Scanning

Setting the scanner to the Long Document Mode enables scanning documents up to 5,588 mm long (220") (or up to 3,000 mm (118.11") with the DR-G2090).

The Long Document Mode can be set with the scanner driver or by the selecting [Long Document] in User Mode.

Setting with the Scanner Driver

By default, the Long Document Mode is set by the scanner driver.

- 1 Open the scanner driver's setting screen. (See p. 76)
- 2 In the [Basic] tab, click the [Setting] button of [Page Size] [Page Size Settings] dialog box will open.

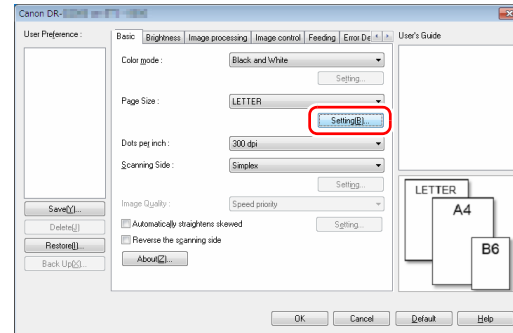

3 Click the [Long Document Mode] tab and specify the Long mode.

Depending on the length of the document, select [Long Document Mode (1000 mm)], [Long Document Mode (3000 mm)], or [Long Document Mode (5588 mm)].

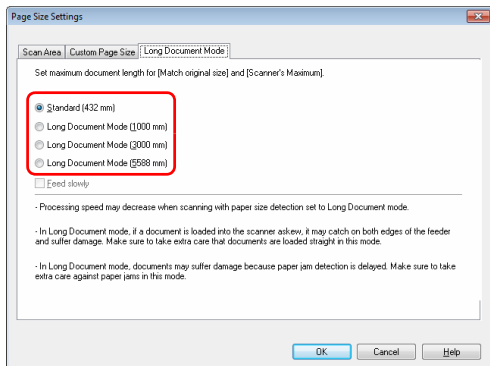

Hint

- The [Long Document Mode (5588mm)] setting is not available in the DR-G2090.
- If you select the [Feed slowly] check box, documents are fed at a slow rate, regardless of resolution or mode settings.

4 Click the [OK] button to close the Settings screen.

Hint

When you set the Long mode, [(Long Document)] will be displayed in [Page Size] in the [Basic] tab.

Setting with User Mode

The Long Document Mode can be set from User Mode. To make this setting in the User Mode, first allow it by the Canon imageFORMULA Driver Setting Tool. "[Configuring Scanner Driver Settings](#)" (See p. 62)

1 Press the Menu key on the operation panel. User Mode is activated. "[User Mode Operations](#)" (See p. 60)

2 Press the ▲▼ keys to select [Scan Setting], and press [OK]. The scan setting items are displayed.

3 Press the ▲▼ keys to select [Long Document], and press [OK]. The long document setting items are displayed.

4 Press the ▲▼ keys to select [Max Document Length], and press [OK].

5 Press the ▲▼ keys to specify the long document mode.

According to the document length, select [Long Document (1000 mm)], [Long Document (3000 mm)], or [Long Document (5588 mm)].



Hint

The [Long Document (5588mm)] setting is not available in the DR-G2090.

6 Press [OK] to accept.

7 Press the Menu key to return to the original screen.



IMPORTANT

- Scanning in Long Document Mode can slow down the processing speed.
- When Long Document Mode is set to [Long Document (3000 mm)] or [Long Document (5588 mm)], the scanned image may be lost if the scanning mode is set to color and Image Quality is set to [Image quality priority]. In this case, scan the document in black and white or reduce the Image Quality setting.
- When Long Document Mode is set to [Long Document (3000 mm)] or [Long Document (5588 mm)], the scanned image may be lost if scanning is performed at 400/600 dpi or the scanning mode is set to color and the scanning side setting is "Duplex". In this case, lower the resolution, scan the document in black and white or select the "Simplex" scanning side setting.

- If a sheet is loaded at a skewed angle when scanning long documents, it may be damaged by contacting both sides of the feed path. Be careful to place the document so that it is not skewed.
- Paper jam detection may react slowly when scanning long documents, which could result in damage to the jammed documents. Be especially careful to avoid paper jams.
- To scan long documents, enable the [Separation Off], and manually feed pages one by one. "[Separation Off](#)" (See p. 65)

Detecting a Document Double Feed

This scanner includes a function to detect document double feeds. This function causes the scanner to automatically stop when it detects that multiple document sheets have been fed at the same time. You can also specify whether to save the scanned image after scanning has finished and continue scanning the document (double feed detection ignore function).

To use the double feed detection function, you must first open the scanner driver settings screen and enable double feed detection. It is also necessary to set [Rapid recovery system] to use the double feed detection ignore function.

Setting procedure

- 1 Open the scanner driver's setting screen. (See p. 76)
- 2 Open the [Error Detection] tab.
- 3 Select either the [Detect by Length] or the [Detect by Ultrasonic] check box (or both).

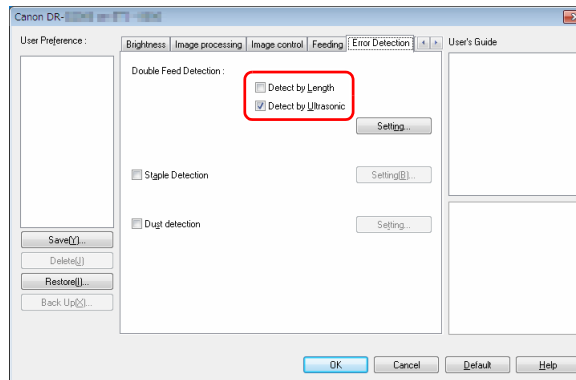

- 4 To also use the double feed detection ignore function, open the [Others] tab, select the [Rapid recovery system] check box, and click the [Setting] button.**

The [Rapid Recovery System Settings] dialog box opens.

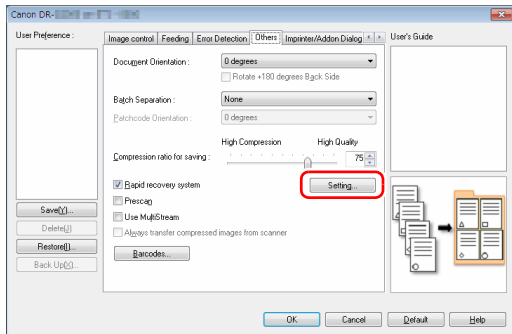

- 5 Select [Show a continue dialog and stop scanning], and click the [OK] button.**

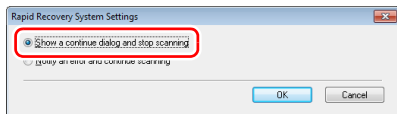

Hint

If [Notify an error and continue scanning] is selected, feeding does not stop when double feeding is detected, but it is notified by the scanner's buzzer or LED.

- 6 Click the [OK] button to close the settings screen.**

! IMPORTANT

- If documents like plastic cards are scanned, it may be falsely detected as a double feed.
- Depending on the paper type and paper thickness, false detection of double feed may occur. If the double feed detection malfunctions, clear the [Detect by Ultrasonic] check box of the [Error Detection] tab.

What to do when a double feed is detected

When not using the double feed detection ignore function

If a document double feed is detected during scanning, document feeding stops when the double fed documents are ejected. When this happens, the following error is displayed in the operation panel. "Error Message" (See p. 138)

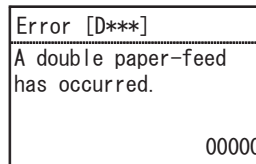

Also, a message screen is displayed to notify you that a double feed has been detected.

When using the double feed detection ignore function

If a document double feed is detected during scanning, document feeding stops when the double fed documents are ejected. The following error is displayed in the operation panel.

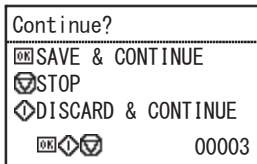

Also, the [Rapid Recovery System] screen appears to enable you to specify whether to continue scanning.

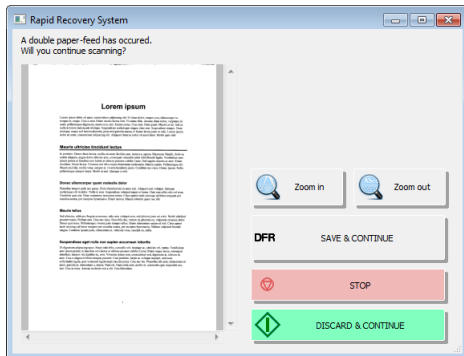

Buttons of [Rapid Recovery System] Screen	Operation Panel Keys	Description
[SAVE & CONTINUE]	OK Key	Saves the preview image as a scanned image and scans the rest of the document.
[DISCARD & CONTINUE]	Start Key	Discards the preview image and continues scanning. Place the double fed document again before clicking this button.
[STOP]	Stop Key	Discards the preview image and stops scanning.

Count the Number of Document Sheets

This function counts the number of document sheets before scanning.

Count-Only Mode

The number of loaded document sheets is counted by simply feeding them through the scanner.



Hint

The Count-Only Mode is executed from the operation panel, and can be used to count document sheets even when no computer is connected.

1 Place the document.

2 Press the Menu key on the operation panel.

User Mode is activated. "User Mode Operations" (See p. 60)

3 Press the ▲▼ keys to select [Count Only], and press [OK].

Count-Only Mode is enabled.



Hint

If "Count Only" is assigned to the Function key, press the Function key to enable Count-Only Mode. "Assigning a Function to the Function Key" (See p. 58)

4 Press the ▲▼ keys to select [Start], and press [OK].

Document counting starts.



Hint

To stop document feeding, press the Stop key.

Verify Scan

The scanner compares the document page count obtained from the Count-Only Mode (or entered manually) with the actual count of document pages scanned, and an error message is displayed if the two counts do not match.

1 Open the scanner driver's setting screen. (See p. 76)

2 On the [Feeding] tab sheet, select the [Verify Count] check box.

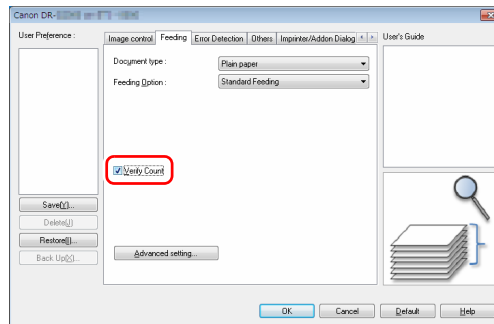

3 Click the [OK] button to close the settings screen.

4 Set the counter in the Count-Only Mode. (See p. 56)



Hint

The document page count can be specified by using the count obtained from the Count-Only mode or by pressing the ◀▶ keys to enter a number.

5 Press the Start key.

Verification scanning starts.



Hint

If the specified count is not met or is exceeded when scanning is finished, one of the following errors is displayed on the operation panel. "Error Message" (See p. 138)

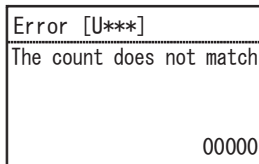

Resetting the counter

The number of counted documents can be reset in the Count-Only Mode.

1 Press the Menu key on the operation panel.

User Mode is activated. "User Mode Operations" (See p. 60)

2 Press the ▲▼ keys to select [Count Clear], and press [OK].

Count-Only Mode is enabled.



Hint

If "Count Clear" is assigned to the Function key, press the Function key to reset the counter. "Assigning a Function to the Function Key" (See p. 58)

3 Press the ▲▼ keys to select [Reset], and press [OK].

The counter is reset.

Assigning a Function to the Function Key

You can use the Canon imageFORMULA Driver Setting Tool to assign one of the following functions to the Function key on the operation panel.

- Count Clear
- Count Only
- Manual Feeding
- Batch Separation

By pressing the Function key, you can enable/disable the assigned function.

IMPORTANT

A USB connection is required to make this setting with the Canon imageFORMULA Driver Setting Tool. When connected via wired LAN, making this setting with the Canon imageFORMULA Driver Setting Tool is ineffective.

Hint

The scanner's factory default Function key assignment is "Count clear".

1 Open the Setting Screen in the Canon imageFORMULA Driver Setting Tool. (See p. 97)

2 On the [Control] tab sheet, click the [Setting] button for [Hardware].

The Hardware Settings dialog box appears.

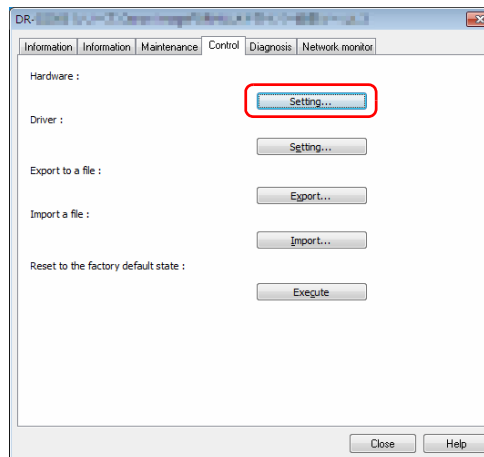

3 Select the function to assign to the Function key from the [FUNCTION] list on the [Button control] tab sheet.

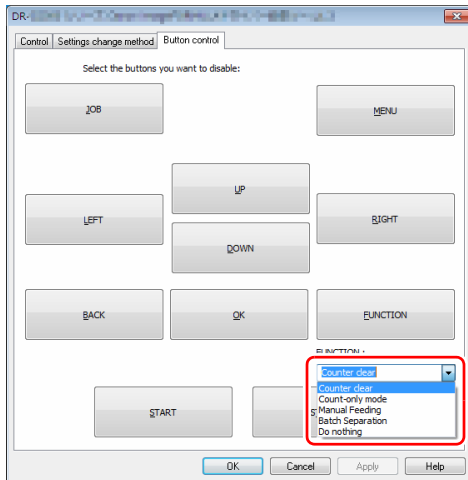

4 Click the [OK] button to close the settings screen.

About User Mode

The User Mode provides the user with the capability to change certain scanner functions.

User Mode Operating Procedure

User Mode operations are controlled by the following procedure.



Hint

Operating procedures differ according to User Mode function. For details, refer to the indicated pages. "[User Mode Functions](#)" (See p. 65)

1 Press the Menu key on the operation panel.

User Mode is activated.

2 Press the ▲▼ keys to select a menu item, and press [OK].

- If there are setting items with no underlying hierarchy, the setting mode is activated.
- Functions with no setting items or underlying hierarchy are simply enabled. (To Step 4)
- If the menu contains setting items, the settings in the underlying hierarchy are displayed. Repeat this step to select from the menu.

The menu hierarchy and menu items that can be selected are as follows.

First hierarchy	Second hierarchy	Third hierarchy
Separation Off	—	—
New File	—	—
Scanner Setting	Sleep	—
	Auto Power Off	—
	Display Contrast	—
	Buzzer	Volume
		Timing
	Key Repeat	—
Language	—	

First hierarchy	Second hierarchy	Third hierarchy	
Scan Setting	Double Feed	—	
	Separation Force	—	
	Separation Off (continuous manual feeding)	On/Off	
		Roller Rotating Time	
	Staple Detection	—	
	Long Document	Max Document Length	
		Speed	
	Tray position	—	
	Feed Interval	—	
	Dust Detection	—	
Count Only	Double Feed	—	
	Staple Detection	—	
	Start	—	
Count Clear	—	—	
Imprint Test	Font	—	
	Head Cleaning	—	
	Start	—	

First hierarchy	Second hierarchy	Third hierarchy
Maintenance	Total Scan	—
	Image Sensor LED On	—
	Feed Cleaning Sheet	—
	Pick Roller Kit	—
	Cartridge Ink	—
	Image Sensor On Time	—
	Feed Roller	—
	Platen Roller	—
	Exit Roller	—
	Separation Pad	—
	Board On Time	—
	Version	—

First hierarchy	Second hierarchy	Third hierarchy
Network	LAN Information	IP Address
		Subnet Mask
		Default Gateway
		MAC Address
	LAN Setting	The LAN setting screens are displayed in the following order. DHCP (Off) → IP Address → Subnet Mask → Default Gateway
		Time Out Setting

- 3** Press the ▲▼◀▶ keys to select, and press [OK] to accept.



Hint

- For adjustment functions such as [Display Contrast], adjust the setting with the ◀▶ keys and accept with the OK key.
- On the [Count Only] screen, pressing the ◀▶ keys increments or decrements the displayed count.

- 4** Press the Menu key to return to the original screen.

Configuring Scanner Driver Settings

Some User Mode menu items can also be set with the scanner driver. Whether you make settings with the scanner or with the scanner driver can be changed using the Canon imageFORMULA Driver Setting Tool.



IMPORTANT

A USB connection is required to make this setting with the Canon imageFORMULA Driver Setting Tool. When connected via wired LAN, making this setting with the Canon imageFORMULA Driver Setting Tool is ineffective.

- 1** Open the Setting Screen in the Canon imageFORMULA Driver Setting Tool. (See p. 97)

2 On the [Control] tab sheet, click the [Setting] button for [Hardware].

The Hardware Settings dialog box opens.

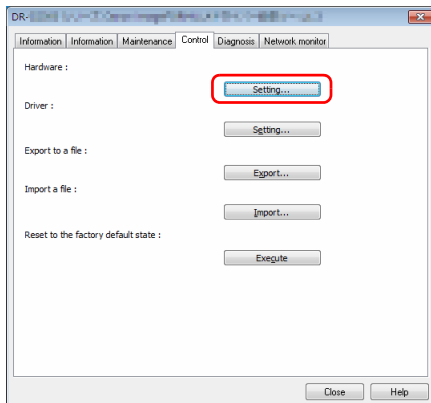

3 Change the setting method on the [Settings change method] tab sheet.

- To make setting with the scanner, select [on Scanner panel].
- To make setting with the scanner driver, select [on PC].

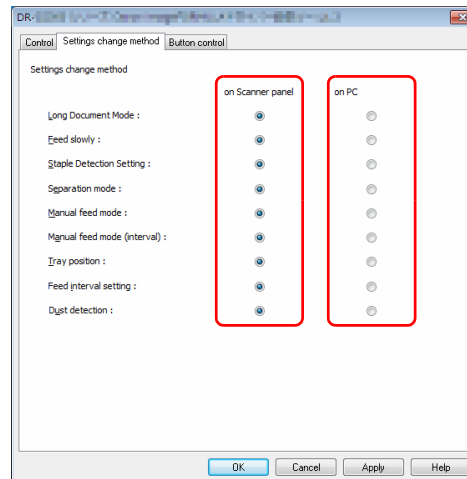

**Hint**

The menu item names in the Canon imageFORMULA Driver Setting Tool and those in the scanner correspond as follows.

Driver Setting Tool Menu Item Name	Scanner Menu Item Name
Long Document Mode	Long Document Mode (Max Document Length)
Feed slowly	Long Document Mode (Speed)
Staple Detection Setting	Staple Detection
Separation mode	Separation Force
Manual feed mode	Manual Feed (On/Off)
Manual feed mode (interval)	Manual feed mode (Roller rotating time)
Tray position	Tray position
Feed interval setting	Feed Interval
Dust detection	Dust Detection

4 Click the [OK] button to close the settings screen.

User Mode Functions

The User Mode has the following functions.

Separation Off

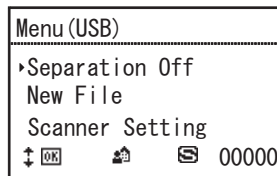

The manual feeding mode is enabled and the  icon is displayed. The Document Feed Tray is raised so that documents can be fed manually one sheet at a time. ["Manual Feeding"](#) (See p. 44)
If the scanner is already in the manual feeding mode, selecting [Separation Off] and then [OK] disables the manual feeding mode.

New File

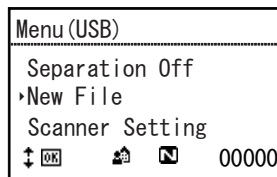

Enables the File Separation function, and  icon appears. When scanning documents in multiple batches, batch file separation occurs each time you load the next batch and resume scanning. In order to use this function, [Panel] must first be selected for [Batch Separation] on the [Others] tab sheet in the scanner driver. Unless [Panel] is selected for [Batch Separation], separate batch files are not produced even when [New File] is selected. When the File Separation function is enabled, selecting [New File] and pressing the OK key disables the File Separation function.

Scanner Setting

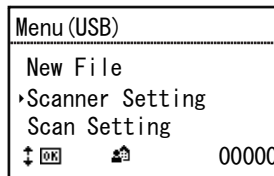

Select the following menu items to configure scanner operation.

Sleep

Selects the amount of time (240, 60 or 10 minutes) from when the scanner is last used to when it enters Sleep Mode.

Auto Power Off

Sets the Auto Power Off Function.

When set to [On], the Auto Power Off Function automatically turns off the power supply after four hours without scanning or other operation.

Display Contrast

◀▶ Adjusts the display panel contrast with the keys.

Buzzer

Configures the buzzer to sound when operation panel keys are pressed, and when errors occur. Select from the following menu settings.

Volume

Select buzzer volume (low, medium, high).

Timing

Select buzzer timing.

None: No buzzer sound.

Error: The buzzer sounds when a scanner error occurs.

Operation & Error: The buzzer sounds when a scanner error occurs and a operation panel key is pressed.

Key Repeat

Sets the panel display method.

On: The panel display scrolls continuously while a key is pressed.

Off: The panel display scrolls each time a key is pressed.



Hint

Key repeat is effective in the following situations.

- When using the Job Function
- When selecting each of the functions in the User Mode

Language

Select the operation panel language from English, Japanese, French, Italian, German, Spanish, Dutch, Russian, Turkish, Chinese (Simplified), or Korean.

Scan Setting

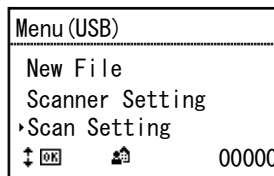

Select the following menu items to configure scan-related settings.

Double Feed

Enable/disable Double Feed Detection.

As-Is: Double Feed Detection is enabled.

Not Available: Double Feed Detection is disabled.

There are two methods of double feed detection: comparing the length of documents, and detecting unevenness between documents by ultrasonic sensors, which can be set by the scanner driver. ["When you want to detect multiple pages fed at the same time"](#) (See p. 84)

Separation Force

If double feeding or a paper jam occurs, consider changing the Separation Mode.

High Separation Mode: Use when high friction between fed sheets makes their separation difficult.

Normal: Use this setting normally.

Thin Paper Mode: Use when feeding fine documents.



CAUTION

In [High Separation Mode], the separation force can be strong enough to damage some documents. In that case, use the [Normal] or [Thin Paper Mode].

Manual Feed

Configures the continuous manual feeding mode. Select from the following menu settings.

On/Off

This mode disables automatic feeding by the Pickup Roller, so that the loaded document stack must be fed by hand onesheet at a time by the operator. "[Continuous manual feeding mode](#)" (See p. 45)

On: The Pickup Roller is disabled.

Off: Documents are fed by the Pickup Roller.

Roller Rotating Time

Set the time (0, 30, 60, 180, or 300 seconds) that the Feed Roller will continue to rotate after feeding in a stack of documents.

Staple Detection

Set the Staple Detection sensitivity level.

High Sensitivity: High Staple Detection sensitivity.

Normal: Normal Staple Detection sensitivity.

Low Sensitivity: Low Staple Detection sensitivity.

Long Document

Configures the Long Document Mode. Select from the following menu settings.

Max Document Length

Sets the maximum length of documents to be scanned. "[Long Document Scanning](#)" (See p. 50)

Long Document (5588 mm): Documents up to 5,588 mm long (220") are automatically detected for scanning.

Long Document (3000mm): Documents up to 3,000mm long (118.11") are automatically detected for scanning.

Long Document (1000mm): Documents up to 1,000mm long (39.37") are automatically detected for scanning.

Default (432 mm): Documents up to 432 mm long (17") can be scanned.



Hint

- Feeding a document longer than the maximum automatically detectable pagelength causes a paper jam, and transport stops.
- The [Long Document (5588 mm)] setting is not available in the DR-G2090.

Speed

Sets the document feeding speed in the Long Document Mode.

Normal: Documents are fed at normal speed.

Slow: Documents are fed at low speed.

Tray position

The Document Feed Tray should be set to fit the maximum number of document sheets to be loaded. "[Preparing the Document Feed Tray](#)"

(See p. 36)

500: Up to 500 sheets

300: Up to 300 sheets

100: Up to 100 sheets



Hint

The [500] setting is not available in the DR-G2090.

Feed Interval

Sets the feed interval. Lengthening the paper feed interval can make it easier to keep ejected documents aligned. The default setting is "Interval 1 (short)".

Different feed intervals can be set depending on the model in use.

DR-G2140: Interval 1 (short), Interval 2, Interval 3, Interval 4, Interval 5, Interval 6, Interval 7 (long)

DR-G2110: Interval 1 (short), Interval 2, Interval 3, Interval 4, Interval 5, Interval 6 (long)

DR-G2090: Interval 1 (short), Interval 2, Interval 3, Interval 4, Interval 5 (long)

Dust Detection

Sets whether to detect dust in the scanning unit.

On (Message & Interrupt): When dust is detected in the scanning unit, a message is displayed on the scanner's display panel and scanning is interrupted.

On (Message & Continue): When dust is detected in the scanning unit, a message is displayed on the scanner's display panel and scanning continues.

Off: Disables the Dust Detection function.

Count Only

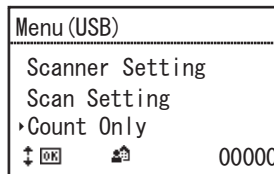

Select the following menu items to make settings related to Count-Only Mode.

Pressing the ◀▶ keys increments or decrements the displayed count.

Double Feed

Enable/disable double-feed detection in Count-Only Mode.

On: Double-feed detection is enabled in Count-Only Mode.

Off: Double-feeding detection is disabled in Count-Only Mode. In Count-Only Mode, double feeding is detected by ultrasonic sensors.

Staple Detection

Enable/disable staple detection in Count Only Mode.

On: Staple detection is enabled in Count Only Mode.

Off: Staple detection is disabled in Count Only Mode.

Start

When [Start] is selected, the documents are fed and counting is started. "[Count-Only Mode](#)" (See p. 56)

Count Clear

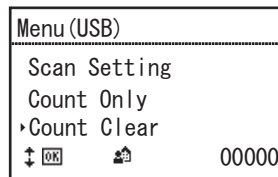

Select [Reset] to reset the count in the display count area (bottom right on the display).

Imprint Test

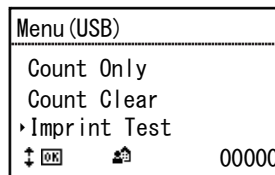

Select the following menu items to make settings related to the optional imprinter.

This is displayed only when the optional Imprinter is installed.

Font

Select the font for imprinter test printing. "[Imprinter Testing](#)" (See p. 127)

It can be set in three stages: [12x12 (Normal)], [8x12 (Normal)], or [12x12 (Thin)].

Head Cleaning

Select [Start] to execute imprinter head cleaning.

Start

Select [Start] to execute imprinter test printing.

Maintenance

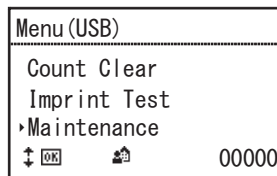

Select the following menu items to display various information about the scanner and to conduct maintenance operations.

Total Scan

Shows the total number of scanned images recorded by the scanner.

Image Sensor LED On

Lights the image sensor LED to make dust easily visible. "[Cleaning the Sensors](#)" (See p. 106)

Feed Cleaning Sheet

Sets the feeding mode for the cleaning sheet. After loading a dedicated cleaning sheet, press the Start key to feed the cleaning sheet and remove dust in the feed path.

Pick Roller Kit

Select this to replace the document feed rollers (pickup, feed, and retard rollers) and display the number of feeds since the counter was reset. Select [Reset] to reset the roller kit feed count. "[Checking and Resetting the Page Counter](#)" (See p. 111)

Cartridge Ink

The amount of remaining cartridge ink is displayed. This is displayed only when the optional Imprinter is installed.

! IMPORTANT

The amount of remaining cartridge ink displayed is an approximation and may differ from the actual amount remaining.

Image Sensor On Time

Displays the total lighting time of the image sensor.

Feed Roller

Displays the total number of sheets fed by the feed roller.

Platen Roller

Displays the total number of sheets fed by the platen roller.

Exit Roller

Displays the total number of sheets fed by the exit roller.

Separation Pad

Displays the total number of sheets fed by the separation pads. Select [Reset] to reset the separation pad feed count.

Board On Time

Displays the power board total runtime.

Version

Displays the scanner version.

Network

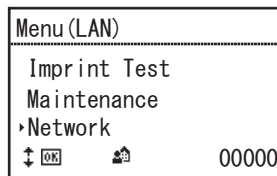

This menu item is displayed only on network models. Select the menu items below to check/change network settings.

LAN Information

The following network information stored in the scanner is displayed.

- IP address
- Subnet Mask
- Default Gateway
- MAC address

LAN Setting

If not using a DHCP server, set the following network information for the scanner.

- DHCP
- IP address
- Subnet Mask
- Default Gateway

Selecting [Off] for [DHCP] moves to the setting screen for network information such as the IP address.

The LAN setting screens are displayed in the following order.

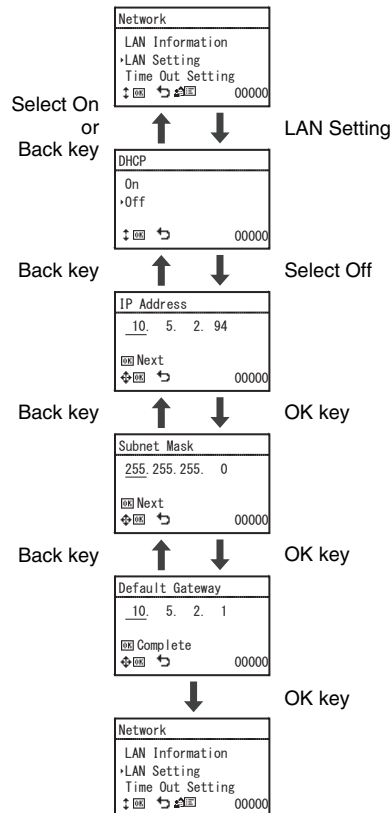

IMPORTANT

- If the entered IP address is "0.0.0.0", "255.255.255.255", "127.xxx.xxx.xxx", or "169.254.xxx.xxx", a warning screen is displayed and the entry is rejected.
- If the entered subnet mask is not a contiguous left-justified value, a warning screen is displayed and the entry is rejected.
- If the entered default gateway is "0.0.0.0", "255.255.255.255", "127.xxx.xxx.xxx", "169.254.xxx.xxx", a warning screen is displayed and the entry is rejected.

Hint

Network information can also be set in the Web menu. ["Network Setting"](#) (See p. 101)

Time-Out Setting

Set the time (Off, 30 or 60 seconds) from displaying the Job screen to returning to the PC selection screen.

If no operation occurs before the time selected in this menu has elapsed, the screen returns to the PC selection screen.

Selecting a Scan Job

This scanner's scan methods include the "job function", which executes scanning by operation panel operation.

About the Job Function

The job function selects and executes jobs (favorites) that have been registered with CaptureOnTouch by pressing the Job key on the operation panel.

Job registration stores scanning conditions such as image file format, save destination and image processing settings for each job to be used with the Job Function.

For details on registering jobs, see the help of CaptureOnTouch.

Executing Jobs (with USB connection)

1 Press the Job key on the operation panel.

The jobs registered on the computer connected via USB are displayed.

2 Press the ▲▼ keys to select the job.

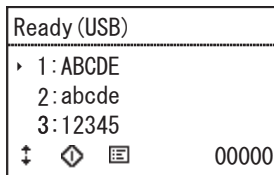

3 Press Start.

Scanning starts.

Executing Jobs (with LAN connection)

1 Press the Job key on the operation panel.

The PC selection screen appears.

2 Press the ▲▼ keys to select a computer for connection.

The jobs registered on the selected computer are displayed.

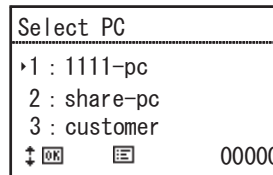

! IMPORTANT

If CaptureOnTouch is not running on the connected computer, the jobs are not displayed.

3 Press the ▲▼ keys to select the job.

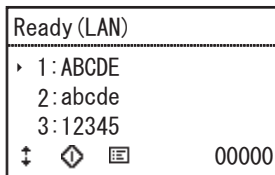

4 Press Start.
Scanning starts.

Scanning with CaptureOnTouch

What is CaptureOnTouch?

CaptureOnTouch is a scanning application that enables you to scan a document with a simple operation merely by selecting the screen panel.

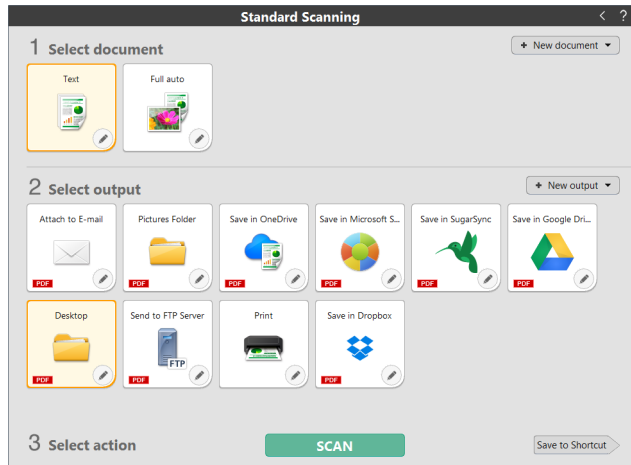

For details about the operations and functions, see the help of CaptureOnTouch.

Setting the Scanner Driver

When you load the driver for the first time, the selected scanner and a dialog for selecting the default paper size are displayed.



Hint

- These settings will apply when [Default] is clicked in the ISIS driver dialog box.
- For the TWAIN driver, the default size will be set to A4 and this cannot be modified.

To scan documents with an application such as CaptureOnTouch, open the scanner driver and configure the scanning conditions and other settings.

This section describes the configuration and functions of the scanner driver.

Configuration and Functions of the Scanner Driver

The scanner driver consists of the following tabs.



Hint

For details on the setting screen, see the Help of the scanner driver. Click the [Help] button of the driver to display help related to the corresponding tab or dialog box.

[Basic] tab

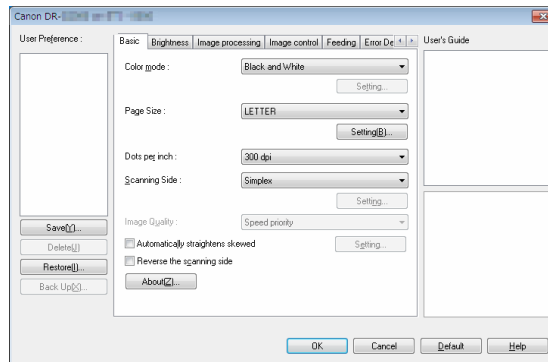

Configure basic scanning conditions such as the mode, page size, resolution, and scanning side.

Click [Setting] button of [Page Size], to set the scan area and the custom paper size registration and long mode.



Hint

Depending on the ISIS compatible application, the application may have its own screen for setting scanning conditions. If the scanner driver is opened in such an application, setting items related to the functions provided by the scanner driver other than scanning conditions will be displayed on the [Basic] tab.

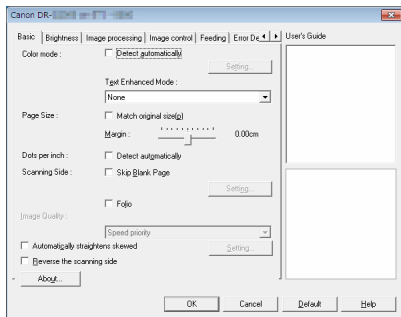

[Brightness] tab

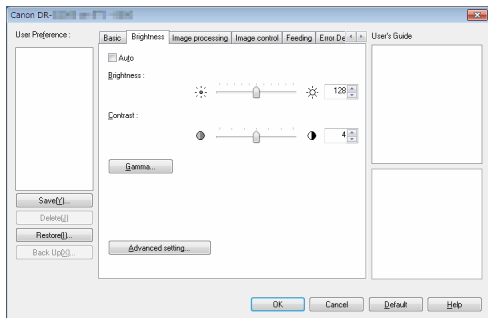

Adjust the brightness and contrast of scanned images. In addition, you can also click [Gamma] and set the gamma correction value for scanned images.

[Image processing] tab

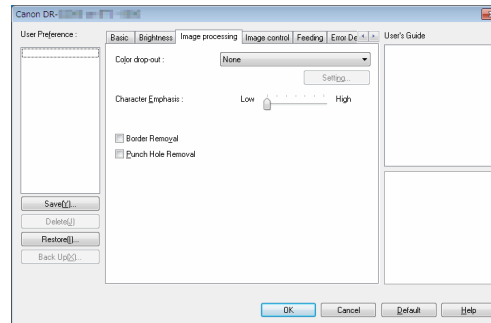

Set the processing method for scanned images.

[Image control] tab

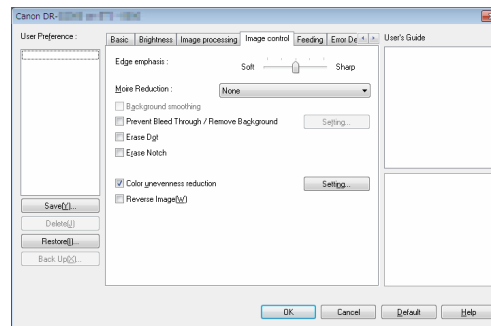

Set the image control method for the scanned image.

[Feeding] tab

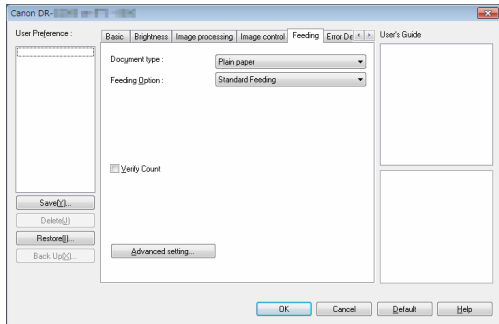

Specify scanner operations related to document feeding.

[Error Detection] tab

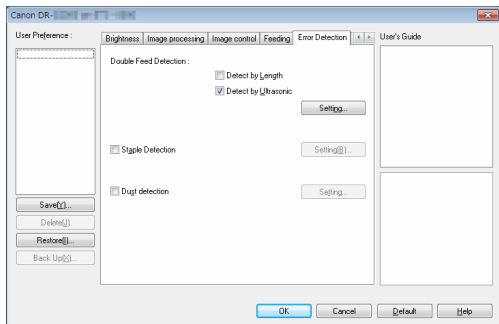

Set the items to be detected as errors during the scan.

[Others] tab

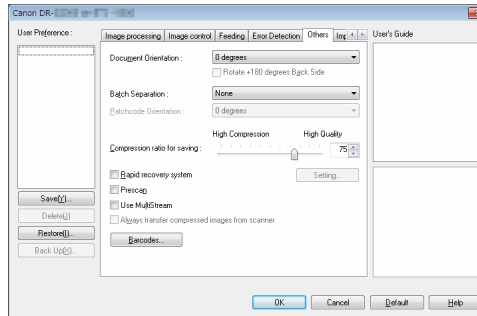

Configure special scan method and image processing settings.

[Imprinter/Add-on Dialog] tab

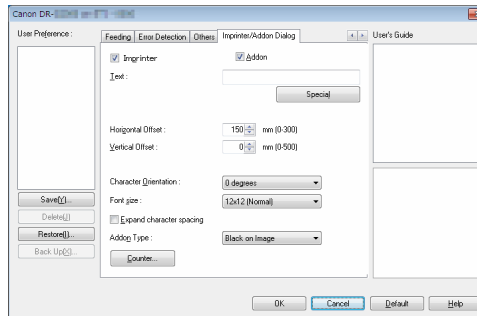

Configure add-ons for scanned images. Also, when the optional Imprinter Unit is attached to the scanner, configure imprinting.

User's Guide

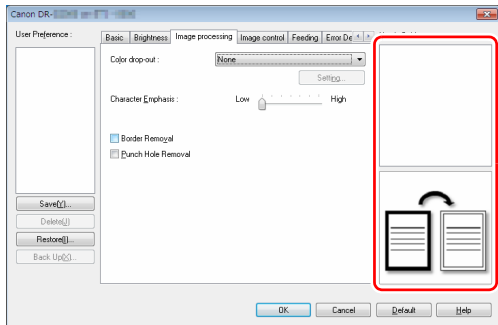

Informs you about the settings changed automatically by the driver. In addition, displays the image for which settings were currently made, in the illustrations.

Setting Basic Scanning Conditions

This section provides an overview of the basic setting items that are the minimum requirements when configuring the scanner settings.

Confirming Basic Conditions for Scanning

When you scan a document, make sure you confirm the [Color mode], [Page Size], [Dots per inch], and [Scanning Side] basic conditions in the Basic settings dialog box.

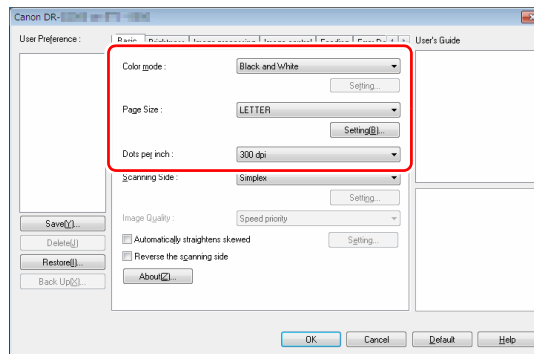

Color mode

Select the scanning mode.

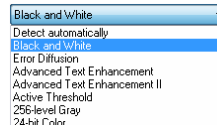

- [Advanced Text Enhancement] and [Advanced Text Enhancement II] remove or process the background color and background surrounding text to enhance the text for easy reading. When [Advanced Text Enhancement II] is selected, you can make the text in scanned images easier to read by adjusting the contrast on the [Brightness] tab.

- [Active Threshold] is intended for batch processing various kinds of documents at once, such as those with thin (light) text or stains. For example, you can batch process documents such as photocopies at once. Brightness-related properties are automatically adjusted based on the text and background of the whole image, enabling consistent reproduction of light characters and removal of background stains.
- [Detect automatically] detects whether the document is in color, grayscale, or black and white. You can configure advanced settings related to the detection method by clicking [Setting]. For details, see the Help.

Page Size

Select the page size that matches the document to be scanned.

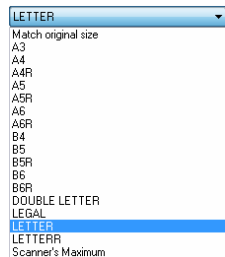

If [Match original size] is selected, the edges of the document are detected and images that match the size of the document are saved.

Dots per inch

Select the scanning resolution.

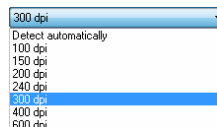

- Higher resolutions provide clearer images but result in larger file sizes and slower scanning.
- When [Detect automatically] is specified, the resolution is detected automatically from the content printed in the document.

Scanning Side

Select which of the sides of the document to scan.

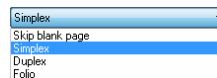

If the scanning side is set to [Skip blank page], the images of blank pages are deleted when images are saved.

Scanning Documents of Unregistered Page Sizes

You can register an unregistered paper of non-standard size with a name, as a custom paper size.

Click the [Setting] button of [Page Size] in the [Basic] tab, to display the [Page Size Settings] dialog box.

Register the paper of non-standard size in the [Custom Page Size] tab.

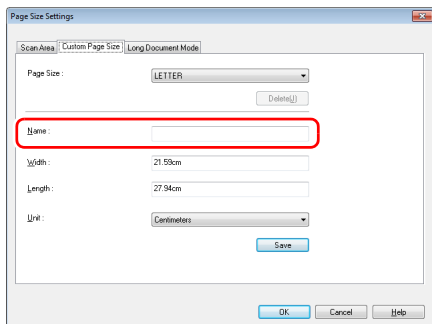

Specifying the Scan Area

Configure the following settings when you want to specify the area of the document to be scanned.

Specifying an area

To scan one area of a larger document, click [Setting] on [Page Size] in the [Basic] tab to display the [Page Size Settings] dialog box.

Designate which area of the document to scan in the [Scan Area] tab.

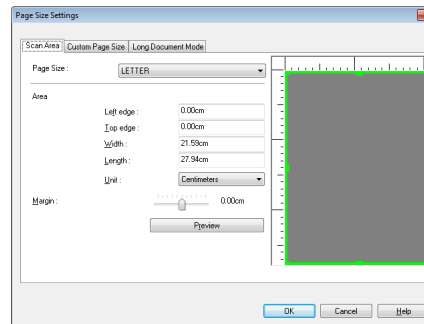

Configuring Scanner Settings According to Purpose

Set the scanning conditions according to the scanning purpose.

When you want to delete the images of the blank pages in two-sided documents

Set the scanning side setting to [Skip Blank Page] on the [Basic] tab to delete the images of the blank pages in the document.

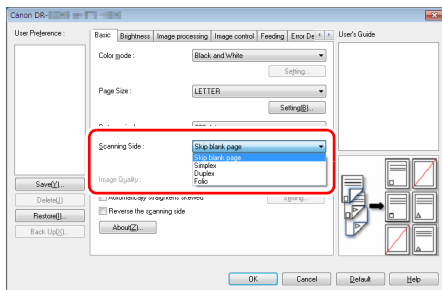

If [Skip Blank Page] is selected, the [Setting] button is enabled, and you can adjust the level for judging whether pages are blank.

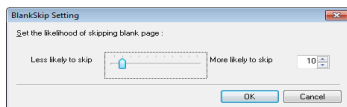

When you want to enhance contours in images

Adjust the edge emphasis setting on the [Image control] tab.

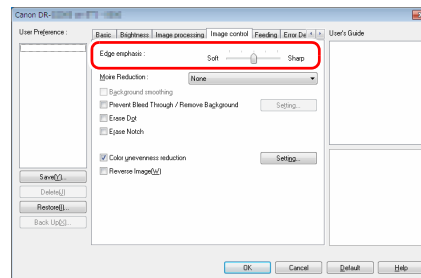

When you want to reduce the moire patterns that appear when color photos in magazines and other documents are scanned at low resolutions

Setting [Moire Reduction] on the [Image control] tab sheet allows you to reduce the moire patterns that are generated when color photos are scanned at low resolutions.

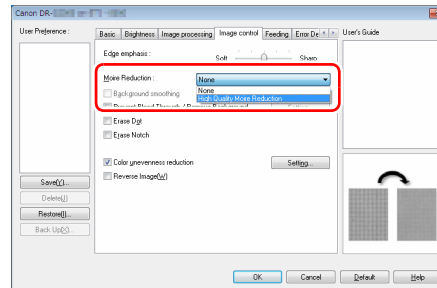

 **Hint**

Moire reduction can be enabled when the resolution is 300 dpi or less, and [High Speed Moire Reduction] is displayed when the resolution is 240 dpi or less.

When you want to reduce the color unevenness

Check the check box of [Color unevenness reduction] on the [Image control] tab to reduce the color unevenness.

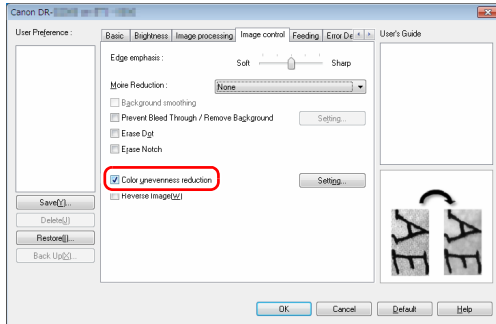

You can control the level of color unevenness by enabling the [Setting] button.

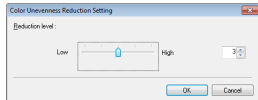

To thicken lines and text in scanned images

Drag the [Character Emphasis] slider in the [Image processing] tab to make lines and text in the scanned images thicker or thinner.

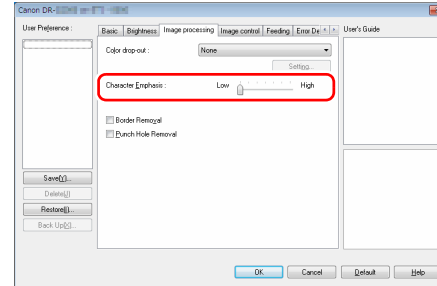

When you want to enhance text that is difficult to read because of factors such as the background of the scanned document

Select [Advanced Text Enhancement], [Advanced Text Enhancement II], or [Active Threshold] for the color mode setting on the [Basic] tab sheet. The background behind the text is removed or processed so that the text is emphasized for better readability.

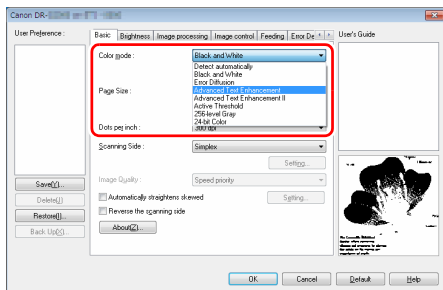

- Advanced Text Enhancement is suitable for a document with a light background color or a document with a non-uniform background (such as a pattern). If the background is uniform, it is removed where it surrounds the text, and if the background is non-uniform, it is processed to enhance text readability.
- Advanced Text Enhancement II is suitable for scanning a document with a uniform background color and light text and background. If the background is non-uniform, such as a pattern, the background may not be able to be completely removed and the text may become difficult to read. If necessary, you can make the text in scanned images easier to read by adjusting the contrast on the [Brightness] tab.

- [Active Threshold] is intended for batch processing various kinds of documents at once, such as those with thin (light) text or stains. For example, you can batch process documents such as photocopies at once. Brightness-related properties are automatically adjusted based on the text and background of the whole image, enabling consistent reproduction of light characters and removal of background stains.

When you want to detect multiple pages fed at the same time

Select the [Double Feed Detection] check box on the [Error Detection] tab. You can enable either one or both of [Detect by Ultrasonic] and [Detect by Length].

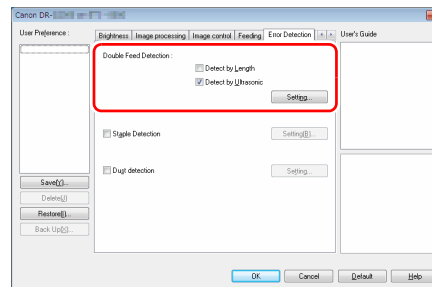

When you want to match the orientation of images to the text when scanning a mixture of pages with different text orientations

Select [Text orientation recognition] in [Document Orientation] on the [Others] tab. The text orientation on each page is detected, and the scanned image is rotated in 90-degree increments to correct the orientation.

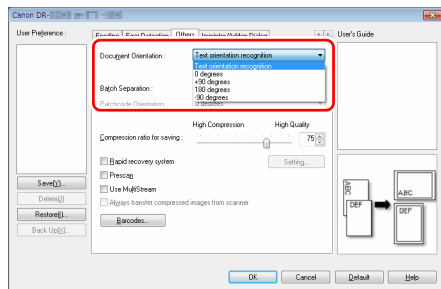

When you want to rotate the images of a document placed horizontally to correct the orientation

Specify the rotation angle in [Document Orientation] on the [Others] tab.

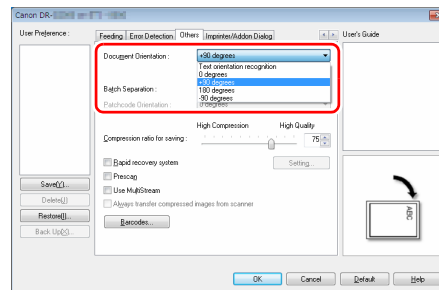

When you want to use batch separation for scanning

When you want to divide and scan a document, you can separate a batch at the timing with which each next document is placed and scanned. (Only enabled for applications that support batch separation.) In this case, set the scanner driver as follows.

- Set [Feeding Option] on the [Feeding] tab to [Panel-Feeding] or [Automatic Feeding].

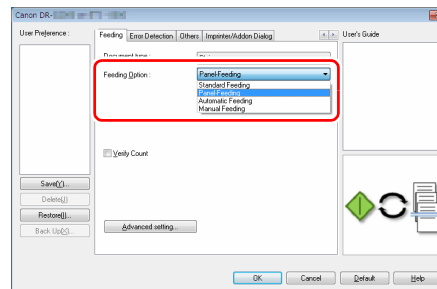

- Set [Batch Separation] on the [Others] tab to [Auto].

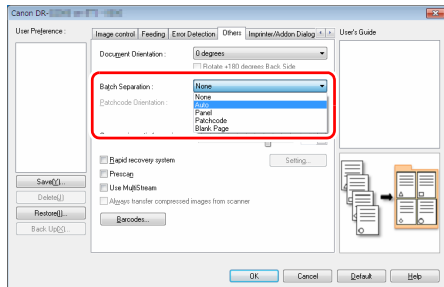

When [Batch Separation] is set to [Auto], the batch is separated after the next document is placed and scanning is continued. For more details about [Blank Page] and [Patchcode], "[More Advanced Scanning Methods \(Batch Separation\)](#)" (See p. 92)

When you want to use MultiStream settings for scanning

Multi-stream allows you to output multiple different scanned images with a single scan operation, and output scanned images with different scanning conditions for each of the front and back pages (MultiStream settings).

When you want to use the MultiStream settings for scanning, select the [Use MultiStream] checkbox on the [Others] tab to display the setting items related to MultiStream, and then configure the setting items in the following order.

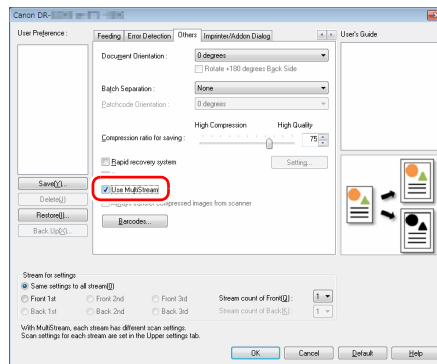

- ① When you want to specify different scanning conditions for the front and back pages of a document, select [Both] for [Scanning Side] on the [Basic] tab in advance.
- ② Specify the number of scanning conditions to apply in [Stream count of Front]. Up to three can be specified.
- ③ Select [Front 1st], and then open the other tabs and set the scanning conditions. Depending on the value specified for [Stream count of Front], configure the remaining [Front 2nd] and [Front 3rd] in the same way.
- ④ When specifying the scanning conditions of the back, configure the settings in the same way as described in ② to ③. In this case, specify [Stream count of Back], and then set the scanning conditions for each of [Back 1st] to [Back 3rd].

Hint

The following shows the setting conditions that can be set in the MultiStream settings.

Tab	Items that can be set
[Basic] tab	[Color mode] and [Dots per inch] (excluding [Auto-detection] for both)
[Brightness] tab	[Brightness] and [Contrast]
[Image processing] tab	[Color drop-out] and [Character Emphasis]
[Image control] tab	[Edge emphasis]
[Feeding] tab	None (all disabled)
[Error Detection] tab	None (all disabled)
[Others] tab	None (only [Use MultiStream] is enabled)

To scan barcodes

After installing the Barcode Module, you can scan barcodes on documents. Click the [Barcode] button on the [Others] tab to configure barcode scanning conditions.

See Help for details about settings.

When you want to remove dots and notches that appear in documents

You can remove dots and notches protruding from object outlines that appear in documents from scanned images.

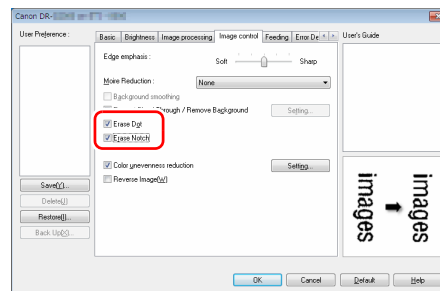

- Select the [Erase Dot] check box to automatically remove isolated black dots (3 x 3 dot size) from white backgrounds (or white dots from black backgrounds).
- Select the [Erase Notch] check box to remove notches that protrude from object outlines in scanned images.

When you want to save a scanner driver setting

When you finish configuring a setting, click the [Save] button of [User Preference] to save the setting.

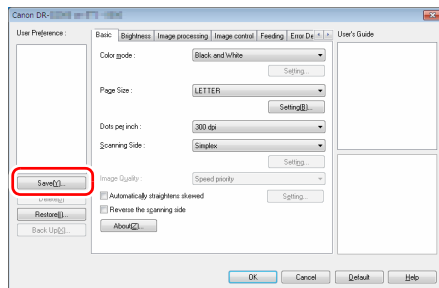

The saved setting is registered to the list. You can delete a setting from the list with the [Delete] button, and save or load a configuration file with the [Back Up] or [Restore] button.

Function Restrictions Depending on Color Mode Setting

Some of the setting items in each of the driver tabs are disabled as follows depending on the setting for [Color Mode] on the [Basic] tab.

[Brightness] tab

Setting value	Contrast
Detect automatically	O
Black and White	O
Error Diffusion	O
Advanced Text Enhancement	X
Advanced Text Enhancement II	O
Active Threshold	O
256-level Gray	O
24-bit Color	O

(O: Available for setting, X: Not available for setting, or auto)

[Image processing] tab

Setting value	Color drop-out	[Character Emphasis]
Detect automatically	X	O ³⁾
Black and White	O	O
Error Diffusion	O	O
Advanced Text Enhancement	O	O
Advanced Text Enhancement II	O	O
Active Threshold	O	O
256-level Gray	O	X
24-bit Color	X	X

(O: Available for setting, X: Not available for setting, or auto)

[Image control] tab

Setting value	Edge emphasis	Background smoothing	Prevent Bleed Through/Remove Background	Erase Dot	Erase Notch	Color Unevenness Reduction	Reverse Image
Detect automatically	O	O	O ¹⁾	O ²⁾	O ³⁾	O	X
Black and White	O	X	O	O	O	O	O
Error Diffusion	O	X	O	X	O	O	O
Advanced Text Enhancement	O	X	X	O	O	O	O
Advanced Text Enhancement II	X	X	X	O	O	O	O
Active Threshold	X	X	X	O	O	O	O
256-level Gray	O	O	O	X	X	O	X
24-bit Color	O	O	O	X	X	O	X

(O: Available for setting, X: Not available for setting, or auto)

1)Not available for setting if all of the following conditions in the [Auto Image Type Detection Settings] dialog box are met.

- [Detection mode] is not set to [Color or Gray]
- When [Mode in case of binary] on the [Settings for in case of binary] tab is set to [Advanced Text Enhancement], [Advanced Text Enhancement II], or [Active Threshold]

2)Not available for setting if either one of the following two conditions are met.

- [Detection mode] in the [Auto Image Type Detection Settings] dialog box is set to [Color or Gray]
- [Mode in case of binary] in the [Settings for in case of binary] tab is set to [Error Diffusion]

3)Not available for setting if [Detection mode] is set to [Color or Gray] in the [Auto Image Type Detection Settings] dialog box.

[Others] tab

Setting value	Prescan
Detect automatically	X
Black and White	O
Error Diffusion	O
Advanced Text Enhancement	O
Advanced Text Enhancement II	O
Active Threshold	O
256-level Gray	O
24-bit Color	O

(O: Available for setting, X: Not available for setting, or auto)

More Advanced Scanning Methods (Batch Separation)

Batch Separation (Insert blank page)

Recognizes blank pages as batch separators and performs batch separation (automatic file separation) when documents containing blank pages are scanned.

On the [Others] tab of the ISIS driver properties, select [Blank Page] from the Batch Separation dropdown list.

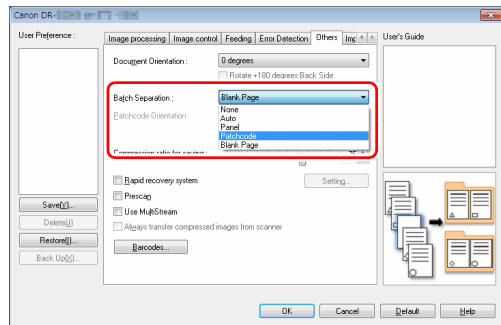

! IMPORTANT

- When [Simplex] is selected in [Scanning Side], blank pages on the scanned side will be recognized as separators. When [Duplex], [Skip blank page], or [Folio] is selected in [Scanning Side], document pages will be recognized as separators when both sides of a page are blank.
- Images of pages recognized as separators will not be saved.

💡 Hint

For batch separation with Panel Feeding or Automatic Feeding, see ["When you want to use batch separation for scanning" on p. 85.](#)

Batch Separation Using Patch Code Sheets

This scanner supports batch separation (automatic file separation) functions by using patchcodes.



By tucking patchcode sheets supplied with this scanner into a document and scanning it, the scanner can automatically separate files by images of documents containing patchcode sheets (or documents after the patchcode sheet).



Hint

Patchcodes are included with this product in PDF format. An application that can read PDF files is required to use this function.

The following patchcodes are installed together with the scanner driver as PDF files.

Type of Patchcode	Pattern	Description
PATCH T (FILE A)		Files are separated from the page after the page printed with this patchcode. You specify in the application whether to include the page printed with the patchcode in the scanned image.
PATCH II (FILE B)		Files are separated from the page printed with this patchcode. The page with the printed patchcode is always included in the scanned image.

The following operations are performed when using patchcodes for scanning.

1 Print patchcode with a printer.

Click [Start] – [All Programs] – [Canon DR-G2000 Series] and then select [Patchcode] from the menu.

Patchcodes can be printed in A4 and letter (LTR) sizes. Open the application and print a patchcode that is the same size as the document to be scanned.

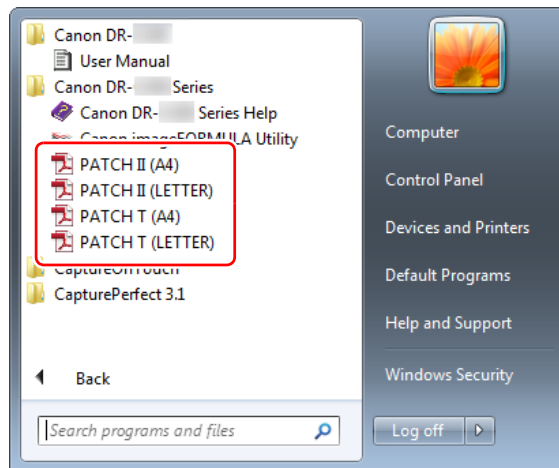



Hint

In Windows 8.1, it is registered at the following location.

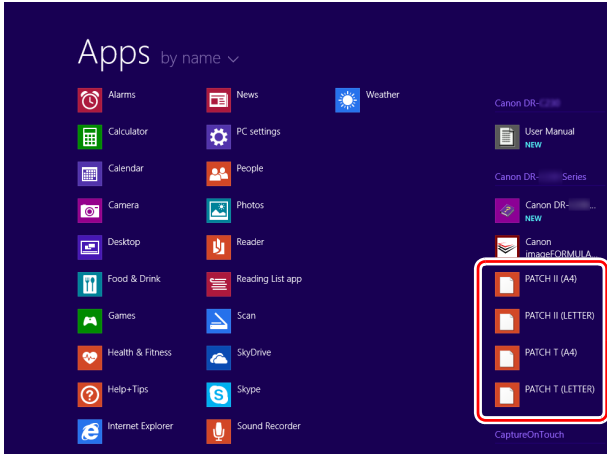

! IMPORTANT

- Patchcodes must be printed in their normal size. If patchcodes are enlarged or reduced, they may not be recognized correctly.
- When copying provided patchcodes to create different sized patchcodes, ensure that the patchcode fits inside the effective range shown in the following diagram. Also, when copying patchcodes, ensure that they are the same size and shade as the original.

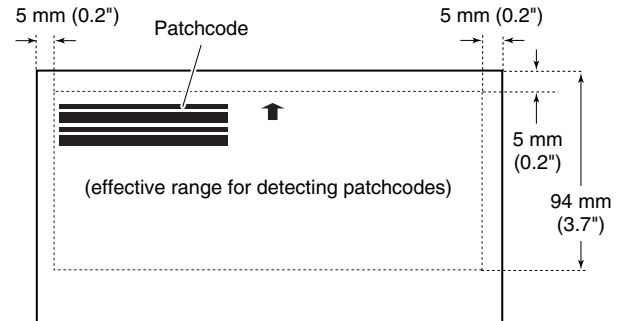

- Keep the patchcode sheet clean. Take particular care to keep the patchcode detection range area clean. Also, do not bend, fold or crease the sheet.

- 2 Place the documents in the scanner after inserting the patchcode sheet in front of the page that separates the files.

Insert the patchcode sheets at the beginning of documents to change file separation.

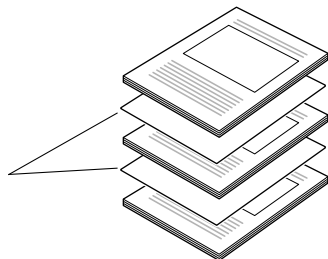

! IMPORTANT

Because patchcodes can only be detected on the front side, load the documents with the patchcode side up.

- 3 Open the scanner driver settings screen and select [Patchcode] in [Batch Separation] on the [Others] tab.

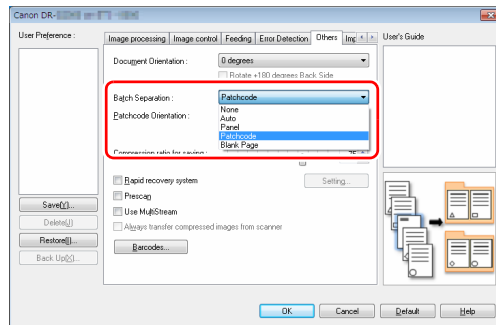

About the Canon imageFORMULA Driver Setting Tool

What is Canon imageFORMULA Driver Setting Tool?

The Canon imageFORMULA Driver Setting Tool can be used to check the information of the scanner, or to configure the maintenance settings.

Canon imageFORMULA Driver Setting Tool consists of the following tabs.

[Information] tab

You can check the farm's version information and scanner information.

[Maintenance] tab

You can reset the counter of the roller, or carry out the shrinkage rate control.

[Control] tab

You can carry out the control settings of hardware and drivers, and perform the read or write of the control settings.
From the configuration of the hardware, you can set the automatic power-off function.

[Diagnostic] tab

You can output or delete the log file.

[Network monitor] tab

You can see the scanners on the network. You can also display a Web menu screen to make various scanner settings. "[Web Menu](#)" (See p. 98)

! IMPORTANT

A USB connection is required to make this setting with the Canon imageFORMULA Driver Setting Tool. When connected via wired LAN, making this setting with the Canon imageFORMULA Driver Setting Tool is ineffective.

Start-up of the Canon imageFORMULA Driver Setting Tool

Click the Start button, then click [All Programs] – [Canon DR-G2000 Series] – [Canon imageFORMULA Driver Setting Tool], in that order. Canon imageFORMULA Driver Setting Tool will start.

Hint

In Windows 8.1, it is registered at the following location.

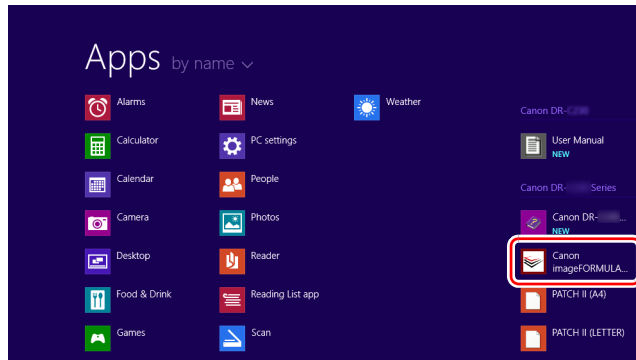

Using the Web Menu

The Web menu is used to display information about the scanner, to set up the network when connecting to a wired LAN, and to configure various Web services. Scanner settings can be configured using a Web browser.

! IMPORTANT

- We recommend the following Web browsers:

Windows	Microsoft Internet Explorer 11 or higher
	Microsoft Edge 38 or higher
	Firefox 3.0.0 or higher
	Chrome 11.0 or higher

- In examples in the following instructions use Internet Explorer 11 and Windows 7. Displays vary depending on the Web browser.

Displaying the Scanner's Web Menu

- 1 Open the Canon imageFORMULA Driver Setting Tool's Settings screen. (See p. 97)
- 2 Click the [Network monitor] tab.

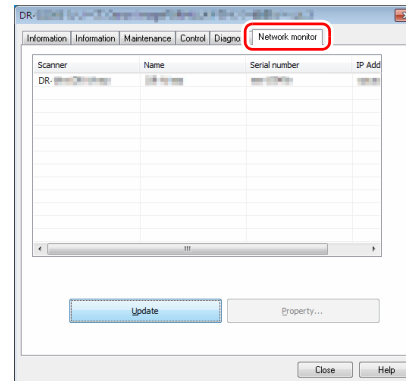

3 Select the scanner from the list, and click [Properties].

The scanner's Web page opens, and the login screen is displayed.

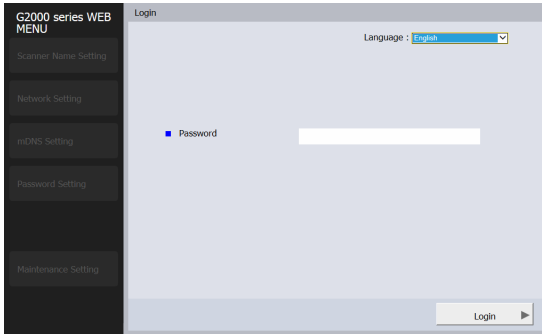

4 Select a display language for the Web page in the [Language] list box.

5 Enter the administrator password in [Password].

Since the administrator password is not set in the scanner's factory defaults, when opening the Web menu the first time, do not enter anything and proceed to the next step. If you changed the administrator password previously via the Web menu, enter that new password.

! IMPORTANT

To ensure security, we recommend changing the administrator password without leaving it as shipped from the factory. Change the password in the [Password Setting] screen of the Web menu. "Password Setting" (See p. 103)

6 Click [Login].

The [Device information] screen appears.

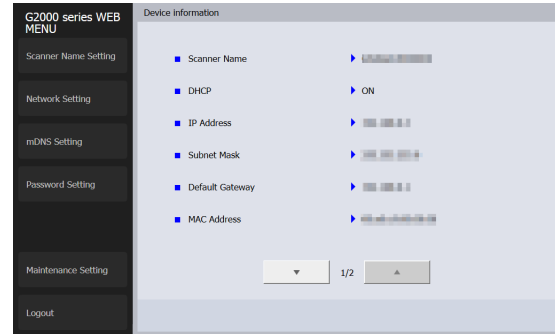

Web Menu Pages

When you click the items on the left menu, the following pages are displayed.

Scanner Name Setting: Displays the scanner name.

Network Setting: Configures the network settings.

mDNS Setting: Configures the mDNS settings.

Password Setting: Configures the administrator password used to log into the Web menu.

Maintenance Setting: Restores the factory default settings and updates the firmware.



Hint

To return to the [Device information] screen from one of its settings screens, click the model name of the scanner that appears at the top of the left menu.

Web Menu Settings

This section describes the setting items on each of the Web menu pages.

Scanner Name Setting

If you click [Scanner Name Setting] on the left menu, the page below is displayed.

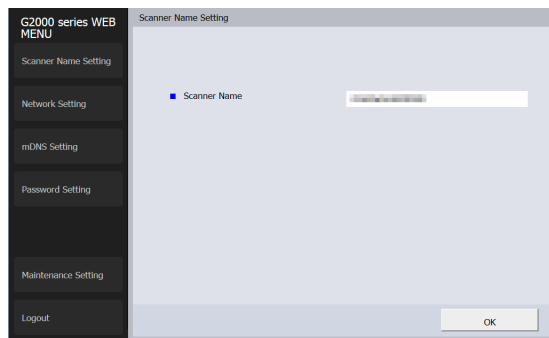

Item	Description
Scanner Name	Sets the scanner name.

Network Setting

If you click [Network Setting] on the left menu, the page below is displayed.

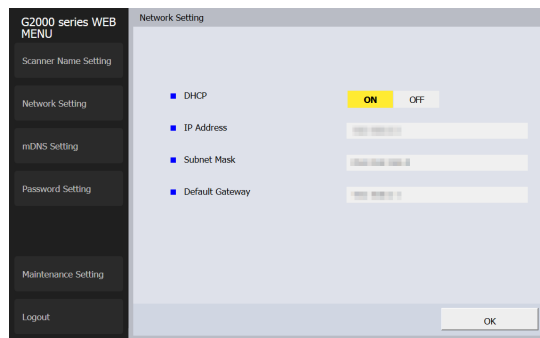

Item	Description	Default Value
DHCP	Enable ([ON]) / disable ([OFF]) the DHCP protocol. To assign an IP address using DHCP, the DHCP server must be running in your subnetwork.	ON

Item	Description	Default Value
IP Address	Set the IP address of the scanner. If DHCP is enabled, the IP address obtained from it will be applied. The value must be four decimal numbers separated by dots and expressed in the [xxx.xxx.xxx.xxx] format.	None
Subnet Mask	Set the subnet mask of the scanner. If DHCP is enabled, it provides the subnet mask. The value must be four decimal numbers separated by dots and expressed in the [xxx.xxx.xxx.xxx] format. When set to [0.0.0.0], a subnet mask appropriate for the IP address is automatically used.	None
Default Gateway	Set the IP address of the scanner gateway. If DHCP is enabled, it provides the default gateway. The value must be four decimal numbers separated by dots and expressed in the [xxx.xxx.xxx.xxx] format. Also, the gateway needs to be running in the same subnetwork as the scanner. If [0.0.0.0] is set, this setting is disabled.	None

mDNS Setting

If you click [mDNS Setting] on the left menu, the page below is displayed.

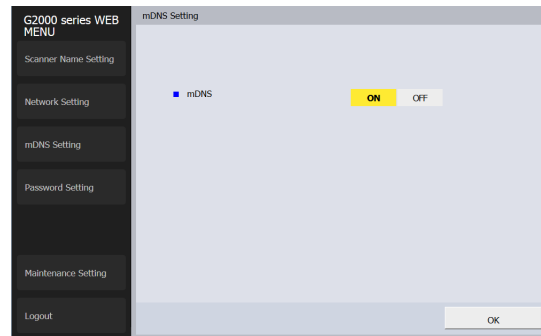

Item	Description	Default Value
mDNS	Enable/disable multicast DNS. This setting allows scanning applications to search for and automatically connect to the scanner. This is normally enabled. When the setting is disabled, you must manually specify the scanner using its assigned IP address to scan from the scanning application.	ON

Password Setting

If you click [Password Setting] on the left menu, the page below is displayed.

Item	Description	Default Value
Current Password	Enter the current password.	None
New Password	Set the administrator password (up to 32 characters) for the scanner. This password is used for authentication when configuring settings by Web browser.	None
New Password (Confirmation)	Used to confirm the password.	None

Maintenance Setting

If you click [Maintenance Setting] on the left menu, the page below is displayed.

On this page, you can restore the scanner's factory default settings and update the firmware.

Item	Description
Initialize	Restore the scanner's factory default settings. If you click [Initialize] and then [Yes] in the screen that appears, the scanner's factory default settings are restored, and the scanner restarts.
Version up	Update the scanner's firmware. Click [Version up], and specify the firmware file in the screen that appears.

Item	Description
Import certificate	You can load and change the server certificate used to access the Web menu with "https://". Click the [Import] button, and the [Import certificate] dialog appears. Specify the certificate file (pfx file) and click [Send] to import.

Daily Maintenance

Clean the scanner on a regular basis, as described below, to maintain peak scanning quality.

CAUTION

- When cleaning the scanner and the inside of the scanner, turn OFF the power switch and disconnect the power cord from the power outlet.
- Do not use spray cleaners to clean the scanner. Precision mechanisms, such as the light source, may get wet, and cause a malfunction.
- Never use paint thinner, alcohol, or other organic solvents to clean the scanner. The exterior of the scanner may become deformed, discolored, or melted. It may also cause a fire or electric shock.
- When opening and closing the upper unit, be careful not to get your fingers caught, as this may result in personal injury.

Cleaning the Scanner

About the Cleaning Cloth

Use the cleaning cloth supplied with the scanner to clean its interior.

Cleaning the Scanner Exterior

To clean the outside of the scanner, wipe off any dirt with a cloth that has been dampened with water and thoroughly wrung out, and then wipe the scanner dry with a clean dry cloth.

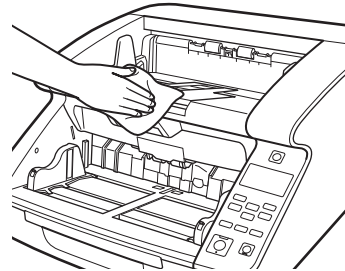

Cleaning the Document Feed Inlet and Transport Path

Dust or paper particles in the document feed inlet or inside the scanner can cause spots to appear on scanned images. Use compressed air to periodically clean dust and paper particles from the inlet and the inside of the scanner. After completing large scanning jobs, turn OFF the scanner and clean out any paper particles.

Cleaning the Sensors

Dust and debris that collect on the sensors may cause documents to be recognized incorrectly. Clean the sensors periodically using a blower, etc. so that dust and debris do not collect on them.

Main unit inner lower side

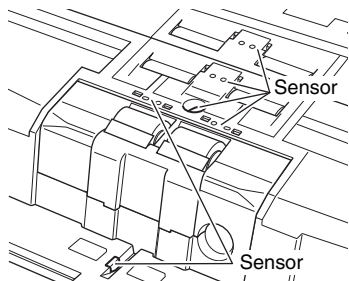

Main unit inner upper side (Upper Unit)

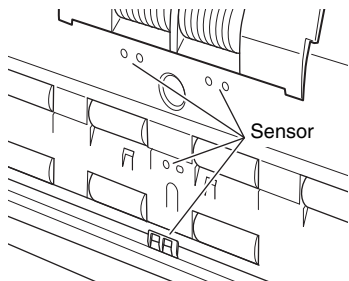

Opening and Closing the Upper Unit

When cleaning the inside of the scanner, make sure to open and close the upper unit using the following procedure.

⚠ CAUTION

When opening and closing the upper unit, be careful not to get your fingers caught, as this may result in personal injury.

Opening the Upper Unit

Pull and hold the open/close lever, and open the unit smoothly until the upper unit stops.

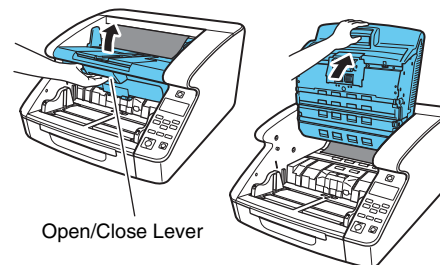

Closing the Upper Unit

Smoothly close the upper unit (1). Further, press both ends of the upper unit to verify that it is securely closed (2).

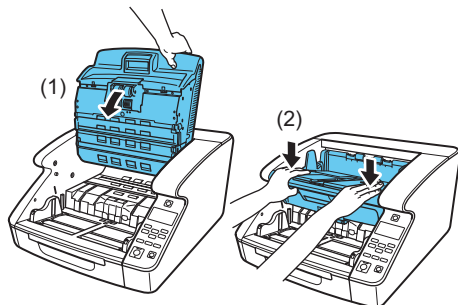

Hint

If the upper unit is open, an error is displayed. "Error Message" (See p. 138)

Cleaning the Scanning Glass, Roller, and Pad

If streaks or dirt appear in scanned images, the scanning glass, rollers or separation pad in the scanner may be dirty. Clean them periodically.

IMPORTANT

Scratches on the sensor glass may cause marks on the images, as well as feeding errors. If you find a scratch on the scanning glass,

contact your local authorized Canon dealer or service representative to have the glass replaced.

- 1 Turn the power switch off, and disconnect the power plug from the power outlet.**
- 2 Close the Document Eject Tray Extension if it is open.**
- 3 Open the upper unit smoothly. (See p. 106)**
- 4 Wipe any dust off the scanning glass with a cleaning cloth or a clean, dry cloth.**

CAUTION

Do not spray water or neutral detergent directly on the scanner. Precision mechanisms, such as the light source, may get wet, and cause a malfunction.

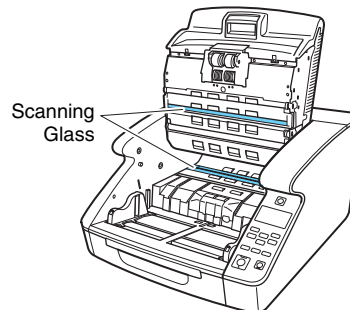

5 Wipe the rollers using a moistened and firmly wrung-out cloth while rotating the rollers.

The rollers are located at the positions indicated in the figure below.

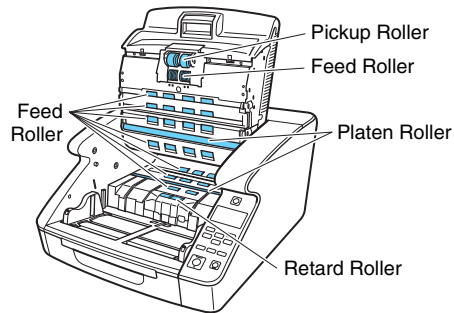

6 Remove the pickup roller, feed roller, retard roller, and retard roller cover. (See p. 113)

! IMPORTANT

Remove the pickup roller, feed roller, and retard roller before wiping away the dirt. The pad is mounted to the retard roller cover. Wipe away the dirt from the pad once the retard roller cover has been removed from the scanner.

7 Wipe the rollers that you removed using a moistened and firmly wrung-out cloth.

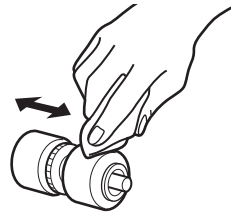

8 Wipe away the dirt from the pad mounted to the retard roller cover while removed using a cloth that has been dipped in water and thoroughly wrung.

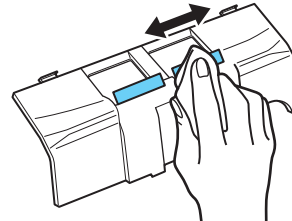

! **IMPORTANT**

When wiping the pad, do not apply excessive force. If you push too hard, the separation pad may peel off.

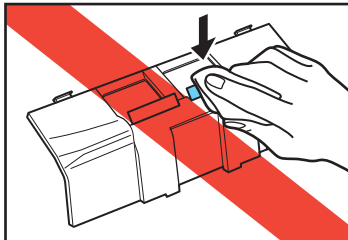

9 Reattach the retard roller and feeding roller. (See p. 113)

10 Smoothly close the upper unit. (See p. 107)

! **IMPORTANT**

If paper jams or double feeds still occur frequently even after cleaning the rollers, roller replacement may be necessary. Contact your service representatives or Canon dealers.

Adjusting the Compression

If the roller mounted inside the scanner is worn, the scan images may become slightly elongated vertically. In such cases, using the [Reduction ratio adjustment] function may reduce the stretching. The reduction ratio adjustment can be made with the Canon imageFORMULA Driver Setting Tool.

["About the Canon imageFORMULA Driver Setting Tool"](#) (See p. 96)

Auto Power OFF Function

An auto power OFF function is built into the device. When the auto power OFF function is ON, the power supply automatically turns OFF after four hours have elapsed without a scan or other operation with the scanner.

The auto power OFF function can be set from the User Mode or with the Canon imageFORMULA Driver Setting Tool. ["User Mode Operations"](#) (See p. 60)

["About the Canon imageFORMULA Driver Setting Tool"](#) (See p. 96)

Power Plug

If you leave the power plug connected to the power outlet for a long period of time, dust may accumulate at the power outlet, and cause a fire or electrical shock. Clean them periodically.

Replacing the Feed Roller

As the rollers start to wear out, feeding quality declines, and document feed errors, such as paper jams, become more likely.

If document feed errors continue to occur after cleaning the rollers, purchase the Roller Replacement Kit and replace the transport rollers (pickup, feed, and retard rollers).

Roller Replacement Cycle

The feeding rollers are consumables. We recommend replacing them after every 600,000 pages fed.

When the rollers have fed more than 600,000 pages, a roller replacement message appears on the display panel whenever the scanner is turned ON. When the scanner is configured to reboot with the computer, a roller replacement message also appears on the computer screen.

Change Parts (Estimate)
Pick Roller Kit
00000

IMPORTANT

- When the roller replacement message appears, purchase the Roller Replacement Kit and replace the rollers by following the relevant steps in the following sections. All three rollers should be replaced at the same time.
 - Pickup Roller ([See p. 113](#))
 - Feed Roller ([See p. 115](#))
 - Retard Roller ([See p. 117](#))
- When the rollers start to wear out, problems such as paper jams and improper document feeding become more likely to occur. If this happens, replace the rollers, regardless of the page count of the roller usage counter.
- The messages displayed on the panel are cleared by resetting the roller counter. However, the messages will continue to be displayed each time the scanner is turned ON until the roller counter is reset.
- Make sure to reset the roller counter after replacing the rollers. "[Checking and Resetting the Page Counter](#)" ([See p. 111](#))

Roller Replacement Kit

The Roller Replacement Kit consists of replacement pickup, feed, and retard rollers. For details, contact your local authorized Canon dealer or service representative.

Product Name: Roller Replacement Kit

Product Code: 3601C002

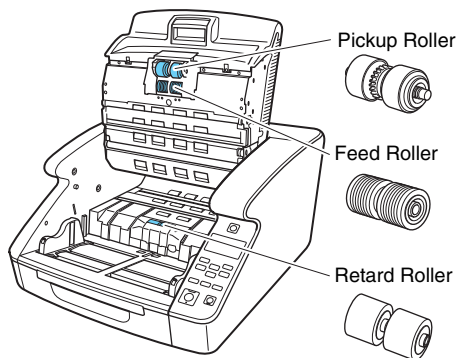

Checking and Resetting the Page Counter

When replacing the rollers and separation pads, the scanner's internal counter must be reset.

Checking and Resetting in User Mode

! IMPORTANT

- User Mode's [Maintenance] - [Pick Roller Kit] and [Separation Pad] shows the number of pages fed since the feed rollers and separation pads were replaced. Make sure to reset the counter when you replace the rollers and separation pads.
- In User Mode, [Maintenance] - [Total Scan] shows the total number of pages fed over the life of the scanner, and cannot be reset.

- 1 Press the Menu key on the operation panel.**
User Mode is activated. "User Mode Operations" (See p. 60)
- 2 Press the ▲▼ keys to select [Maintenance], and press [OK].**
The maintenance setting items are displayed.
- 3 Press the ▲▼ keys to select [Pick Roller Kit] or [Separation Pad], and press [OK].**
- 4 Press the ▲▼ keys to select [Reset], and press [OK].**
The counter is reset to zero.
- 5 Press the Menu key to return to the original screen.**

Checking and Resetting with the Canon imageFORMULA Driver Setting Tool

! IMPORTANT

A USB connection is required to make this setting with the Canon imageFORMULA Driver Setting Tool. When connected via wired LAN, making this setting with the Canon imageFORMULA Driver Setting Tool is ineffective.

- 1** Open the Canon imageFORMULA Driver Setting Tool's Settings screen. (See p. 96)
- 2** On the [Maintenance] tab sheet, click the [Reset] button in [Reset the pick roller feed count] or [Reset the pad feed count].

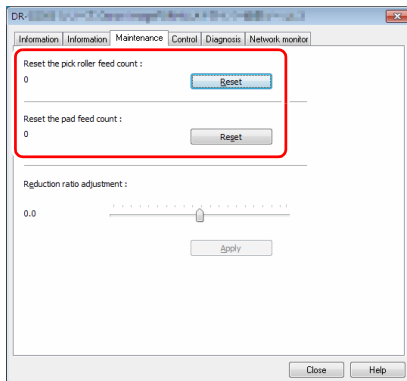

The number of sheets fed by the feed rollers or separation pads is reset.

Removing and Reinstalling the Rollers

To clean or replace the pickup, feed or retard rollers, follow the procedure below to remove and reinstall the rollers.

⚠ CAUTION

- Turn OFF the power switch, and disconnect the power plug from the power outlet when you remove or reinstall the rollers. Leaving the power turned ON may result in an electric shock.
- Do not place excessive force on the rollers when removing or reinstalling the rollers. Deformation of the rollers may cause feed errors.

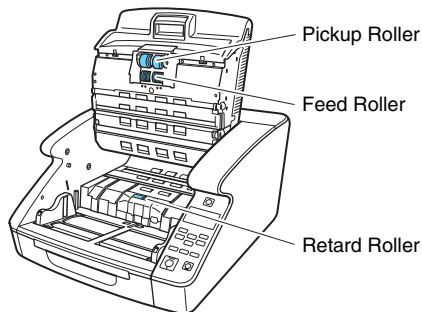

Removing and Reinstalling the Pickup Roller

- 1** Open the upper unit smoothly. (See p. 106)
- 2** Open the roller cover.

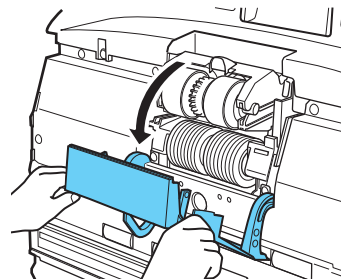

- 3** Open the roller holder.

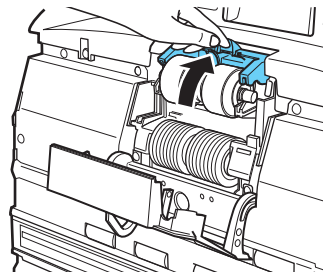



Hint

The roller holder returns to its original position when released.

4 Remove the pickup roller, and install a clean or replacement Pickup Roller.

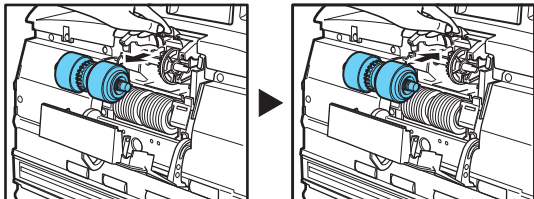

! IMPORTANT

Install the Pickup Roller so that the side with the gear is on the left.

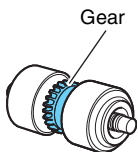

5 Close the roller cover. Make sure that the front unit is completely closed by pushing until you hear a click.

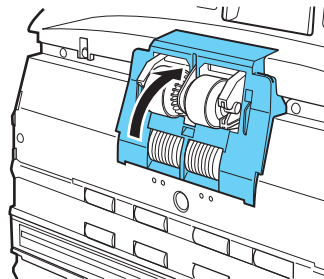

! IMPORTANT

Failure to firmly close the roller holder and roller cover may cause a feed error. Always be sure to check that the roller holder and roller cover are closed.

6 Smoothly close the upper unit. (See p. 107)

Removing and Reinstalling the Feed Roller

1 Open the upper unit smoothly. (See p. 106)

2 Open the roller cover.

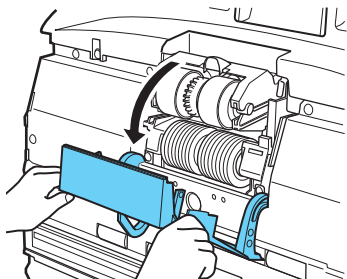

3 Pull the roller lock lever down.

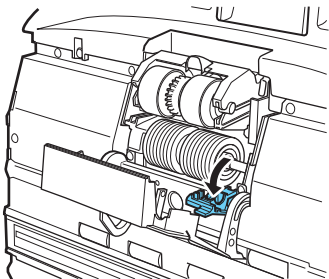

4 Slide the feed roller to the right, and then pull them towards you.

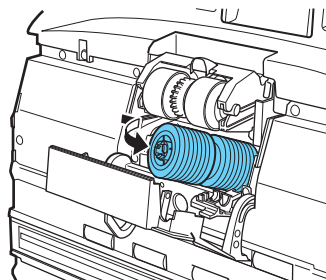

5 Remove the feed roller.

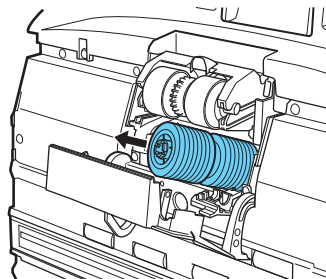

-
- 6** Place the new feed roller on the pin.

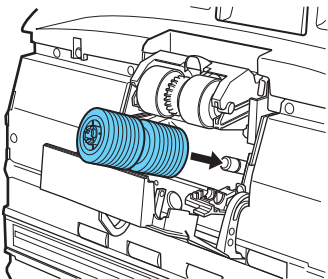

- 7** Put the feed roller in place (1), and align the notch in the roller's axle with the shaft on the scanner (2).

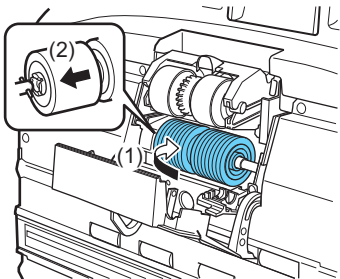

- 8** Push the roller lock lever up to lock the feed roller.

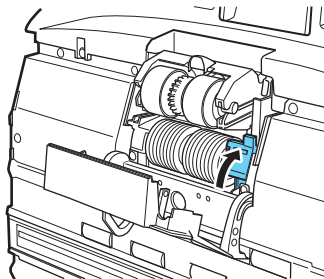

- 9** Close the roller cover. Make sure that the front unit is completely closed by pushing until you hear a click.

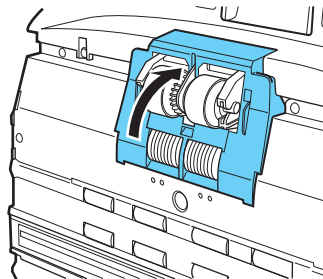

! IMPORTANT

Failure to firmly close the roller cover may cause a feed error. Always be sure to check that the roller cover is closed.

-
- 10** Smoothly close the upper unit. (See p. 107)

Removing and Reinstalling the Retard Roller

-
- 1** Open the upper unit smoothly. (See p. 106)
-
- 2** Grasp and pull the retard roller cover with your fingers to remove it.

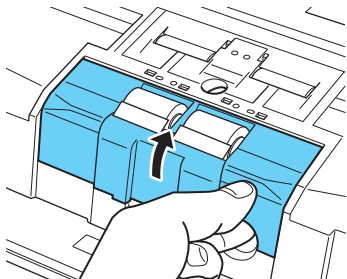

-
- 3** Push the roller lock lever up (1) and move it to the left (2) to unlock the roller.

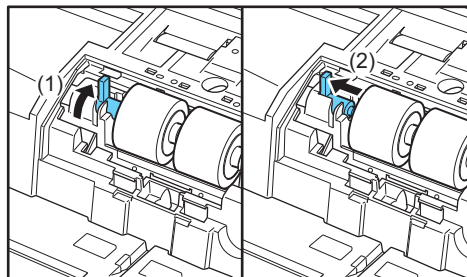

-
- 4** Remove the retard roller, and set a clean retard roller or a replacement retard roller.

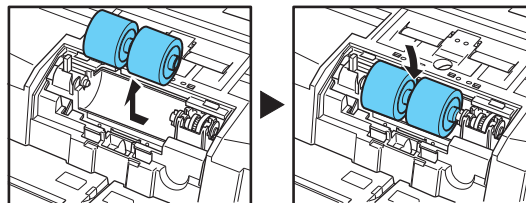

WARNING

The metal sections of the roller can become extremely hot after continuous use. Do not directly touch the metal. Wait until the roller has thoroughly cooled before replacing it.

-
- 5** Align the roller cutout to the axle on the scanner, and slide the roller securing lever in the direction of the arrow.

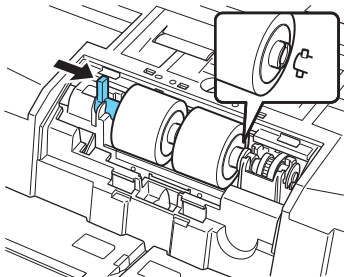

-
- 6** Pull the roller lock lever down to lock the retard roller in place.

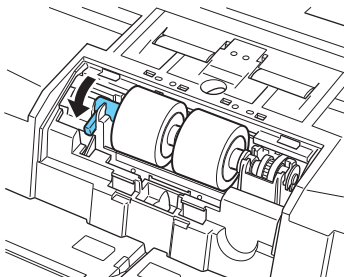

-
- 7** Replace the retard roller cover.

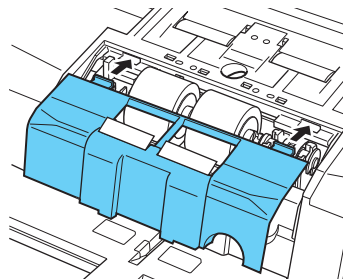

-
- 8** Push the front of the retard roller cover in. Make sure that the front unit is completely closed by pushing until you hear a click.

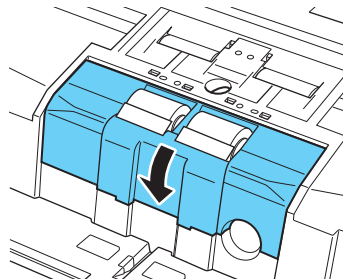

9 Smoothly close the upper unit. (See p. 107)

 **CAUTION**

Make sure that the hook is completely latched and the retard roller cover is not loose. If the retard roller cover is loose, the Document Feed Tray will catch on it causing the scanner to malfunction.

Detaching and attaching the separation pad (retard roller cover)

When replacing the separation pad, perform the following steps to detach it from and attach it to the unit.

When to Replace the Separation Pad (Retard Roller Cover)

The separation pads are consumables. We recommend replacing them after every 6,000,000 pages fed.

When the number of separation pad feeds exceeds 6,000,000, a pad-replacement message appears on the panel whenever the scanner is turned on. Also, when the computer is restarted and recognizes the scanner, the pad-replacement message appears on the computer screen.

Change Parts (Estimate)
Separation Pad
00000

IMPORTANT

- The feed roller and retard roller wear with scanning. A worn separation pad is no longer able to correctly feed a document and can cause paper jams. If documents no longer feed correctly as frequent double-feed, replace the separation pad.
- The messages displayed on the panel are cleared by resetting the counter. However, the messages will continue to be displayed each time the scanner is turned ON until the counter is reset.

- Make sure to reset the counter after replacing the separation pad. "Checking and Resetting the Page Counter" (See p. 111)

Detaching the Separation Pad (Retard Roller Cover)

- 1** Open the upper unit smoothly. (See p. 106)
- 2** Grasp and pull the retard roller cover with your fingers to remove it.

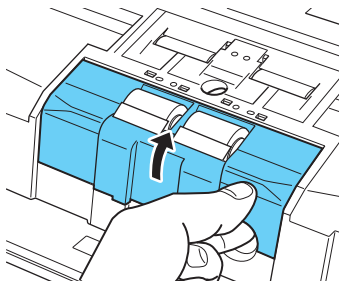

Attaching the Separation Pad (Retard Roller Cover)

- 1** Replace the retard roller cover.

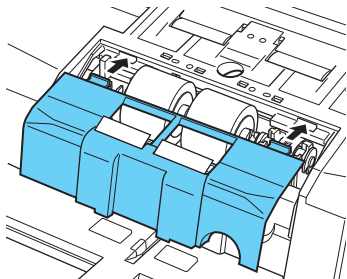

- 2** Push the front of the retard roller cover in. Make sure that the front unit is completely closed by pushing until you hear a click.

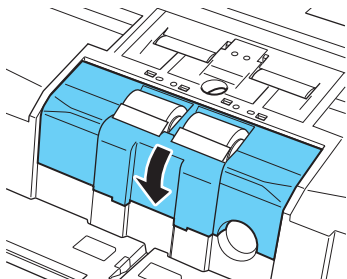

- 3** Smoothly close the upper unit. (See p. 107)

 **CAUTION**

Make sure that the hook is completely latched and the retard roller cover is not loose. If the retard roller cover is loose, the Document Feed Tray will catch on it causing the scanner to malfunction.

Replacement parts

Product Name: Separation pad
Product Code: 3601C005

Imprinter Ink Cartridge Replacement and Cleaning

When the optional imprinter is used, printing will become faint or nonexistent when the ink is depleted. It is recommended to keep a spare ink cartridge available.

About the Imprinter

The ink cartridge for the imprinter that prints on scanned documents is installed in the following location.

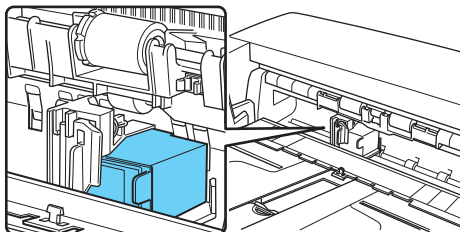

Preparing an Ink Cartridge

Use one of the following red or blue HP ink cartridges. For details, contact your local authorized Canon dealer or service representative.

Product Name: Ink Cartridge (Blue)

Product Code: 3693A002

Product Name: Ink Cartridge (Red)

Product Code: 3693A003

Replacing Ink Cartridges

Replace the ink cartridge using the following procedure.

! IMPORTANT

After replacing an ink cartridge, run a test print to confirm proper printing. "[Imprinter Testing](#)" (See p. 127)

- 1** Spread the document guides all the way to the left and right.
- 2** With your finger, push in the area of the imprinter cover shown by the arrow to release it.

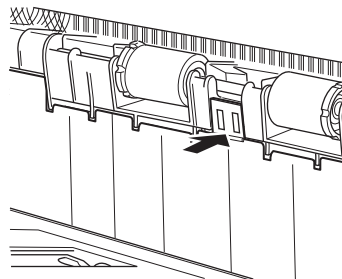

-
- 3** Open the imprinter cover until it makes contact with the eject tray.

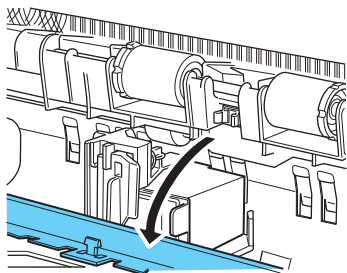

Hint

Perform the steps that follow with the imprinter cover fully open.

-
- 4** Pull the lock lever outward (1) to release the ink cartridge lock (2).

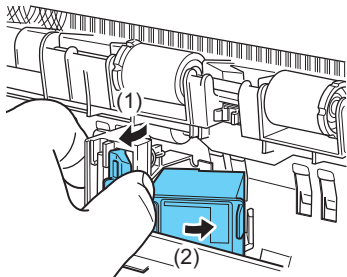

-
- 5** Remove the ink cartridge.

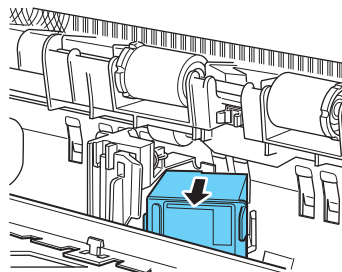

-
- 6** Peel off the seal covering the nozzles of a new ink cartridge.

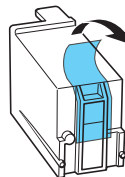

⚠ WARNING

Peel off the seal covering the nozzles of a cartridge only if you are going to use it immediately. Also, avoid touching the metal contacts or nozzles of the ink cartridge.

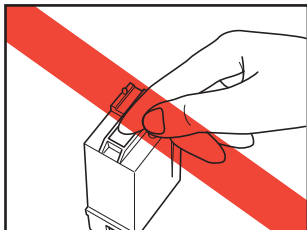

7 Install the new cartridge with the nozzles facing to the right.

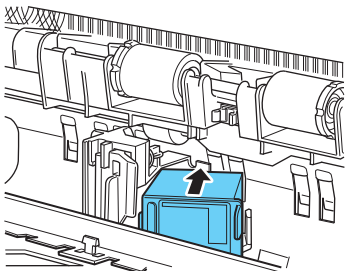

8 Push the ink cartridge as indicated by the arrow until it clicks into place.

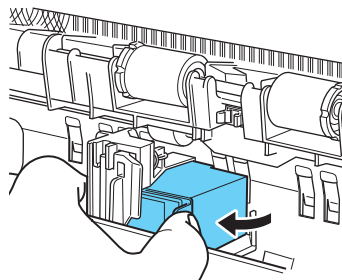

9 Finely adjust the carriage position by moving it left or right, then make sure you can feel it click in. (See p. 125)

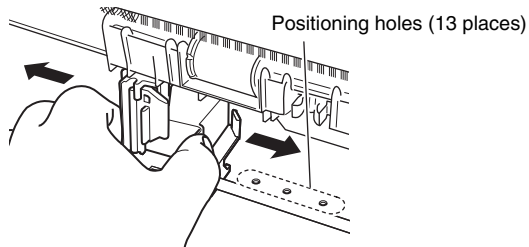



Hint

If you do not feel it click in, the carriage is not aligned correctly with a positioning hole. Always move the carriage to a position where it clicks in.

10 Close the imprinter cover.

With your finger, push in the area of the imprinter cover shown by the arrow to lock it.

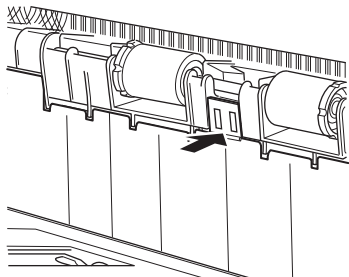

Hint

The imprinter cover will not close unless the carriage is correctly aligned with a positioning hole. If it will not close, check the position of the carriage.

! IMPORTANT

When closing the imprinter cover, make sure that it is locked so that it will not open unexpectedly. An error message appears on the display panel if the imprinter cover is open. ["Error Message"](#) (See p. 138)

Specifying the Printing Position

Manually specify the printing position in the horizontal direction of the document.

To do this, move the carriage left or right and align it with one of the 13 positioning holes.

1 Roughly align the right edge of the lock lever with the desired printing position.

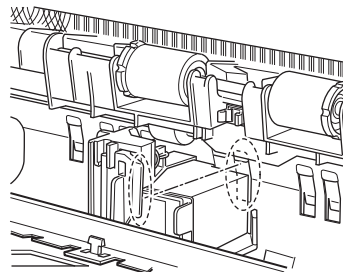

Hint

The position of the right edge of the lock lever indicates the current printing position.

-
- 2** Finely adjust the carriage position by moving it left or right, then make sure you can feel it click in.

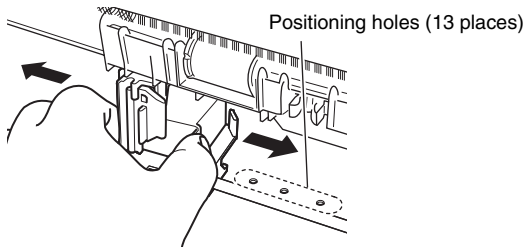

Hint

- If you do not feel it click in, the carriage is not aligned correctly with a positioning hole. Always move the carriage to a position where it clicks in.
- The imprinter cover will not close unless the carriage is correctly aligned with a positioning hole. If it will not close, check the position of the carriage.

Cleaning the Imprinter

Cleaning the Guide Plate

Ink that collects on the guide plate inside the optional imprinter may stain the documents when they are scanned. Clean off the ink with water and a mild detergent on a soft cloth that has been firmly wrung-out, and then thoroughly dry it with a dry cloth.

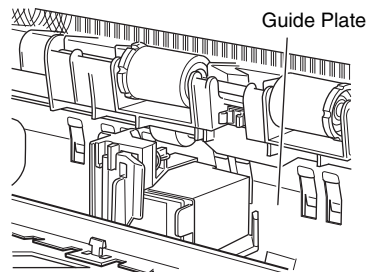

Cleaning the Ink Cartridges

If the imprinter print head nozzles are dirty, printing may become streaked or spotty. To prevent this, periodically remove the ink cartridge and clean the print head with a soft, dry cloth or cotton swab.

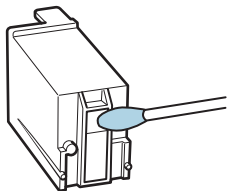

CAUTION

Do not touch the metal contacts on the ink cartridge. Doing so may cause poor connections, resulting in poor print quality.



Imprinter Testing

After replacing an ink cartridge or cleaning the print head, perform a test print to confirm proper printing. Test printing is performed by the [Imprint Test] User Mode selection.

IMPORTANT

Before performing an Imprinter Test, load a sheet of paper into the Document Feed Tray.

Performing an Imprinter Test

Use the following procedure to execute the Imprinter Test.

-
- 1 Load a sheet of paper into the Document Feed Tray for test printing.**

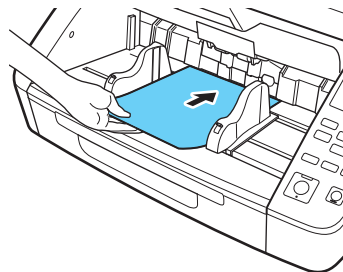

-
- 2 Press the Menu key on the operation panel.**
User Mode is activated. ["User Mode Operations"](#) (See p. 60)

3 Press the ▲▼ keys to select [Imprint Test], and press [OK].

The imprinter test settings are displayed.

4 Press the ▲▼ keys to select [Start], and press [OK].

Test printing of the installed imprinter is executed.

! **IMPORTANT**

If no paper is loaded for test printing, the imprinter test finishes without printing.

5 Press the Menu key to return to the original screen.

Head Cleaning

If lines or streaks appear in the imprinter printout, the printhead nozzle may be clogged. This can be corrected by performing head cleaning.

! **IMPORTANT**

- After head cleaning, run the imprinter test to check printing. (See p. 127)
- If head cleaning does not improve printing, remove the printhead and clean the ink cartridge. (See p. 126)

Head Cleaning

1 Press the Menu key on the operation panel.

User Mode is activated. "User Mode Operations" (See p. 60)

2 Press the ▲▼ keys to select [Imprint Test], and press [OK].

The imprinter test settings are displayed.

3 Press the ▲▼ keys to select [Head Cleaning], and press [OK].

4 Press the ▲▼ keys to select [Start], and press [OK].

Head cleaning executes and finishes.

5 Press the Menu key to return to the original screen.

Common Problems and Solutions

This section provides recommended solutions to common problems. If you have a problem that is not solved by the following, contact your local authorized Canon dealer.

Problem 1 The scanner will not turn on.

- Solutions
- (1) Confirm that the power cord is properly connected.
 - (2) Confirm that the power plug is plugged into a power outlet.

Problem 2 The scanner is not recognized.

- Solutions
- When connecting via USB:**
- (1) Confirm that the scanner is properly connected to the computer with a USB cable.
 - (2) Confirm that the scanner is turned on. See the previous problem (1) if the scanner does not turn on.
 - (3) The computer's USB interface may not support the scanner. The scanner cannot be guaranteed to work with all USB interfaces.
 - (4) Confirm that the supplied USB cable is used to connect the scanner to the computer. The scanner cannot be guaranteed to work with all available USB cables.
 - (5) If the scanner is connected to the computer via a USB hub, try removing the hub and connecting directly to the computer.
 - (6) USB connection is not recognized when connected via LAN. Disconnect the LAN cable, restart the computer, and reconnect the USB cable.

When connecting via wired LAN:

- (1) Check the LAN cable connection.
- (2) The specified IP address may already be in use by another device. Contact your network's system administrator to change the IP address.
- (3) The specified device name may already be in use by another device. Contact your network's system administrator to change the device name. Be careful not to duplicate the device name when more than one scanner is installed.
- (4) LAN connection is not recognized when connected via USB. Disconnect the USB cable, restart the computer, and reconnect the LAN cable.

Problem 3 Documents feed askew (scanned images are slanted).

- Solutions
- (1) Align the document guides to fit the documents as closely as possible, and load the documents so that they feed straightly.
 - (2) Open the Document Feeder Tray Extension and load the documents.
 - (3) Enable [Automatically straightens skewed] in the scanner driver settings.
 - (4) If many pages have been scanned since roller cleaning, clean the rollers. If documents still feed askew, roller replacement or other maintenance may be needed. See "Maintenance" on p. 105 for roller replacement procedures.

Problem 4 Documents are not scanned according to the settings configured in the scanner driver.

Solutions When you scan using [Select document] panel registered with CaptureOnTouch, the CaptureOnTouch settings have priority over the scanner driver settings. Edit settings in the [Select document] panel, or create a new [Select document] panel using the desired scanning conditions.

Problem 5 If white lines or streaks appear in scanned images.

Solutions Clean the scanning glass (both sides) and the feed and retard rollers. If a sticky substance such as glue or correction fluid is found, carefully wipe with just enough pressure to clean the area where the lines appear. If the problem cannot be solved by cleaning, the internal glass may be scratched. Contact your local authorized Canon dealer.

Problem 6 Scanned images are too dark (or light).

Solutions The brightness setting may need adjustment. Adjust the [Brightness] setting on the [Brightness] tab sheet of the scanner driver: higher if the images are too dark, and lower if too light.

Problem 7 Text or images bleed through from the back side of documents to appear in scanned images.

Solutions

- (1) Increase the [Brightness] setting on the scanner driver's [Brightness] tab sheet. Alternatively, enable the "Prevent Bleed Through/Remove Background" setting.
- (2) If the paper is very thin, photocopy the original and scan the copy.

Problem 8 Duplex (two-sided) scanning is not possible.

Solutions Duplex scanning is not possible if the Scanning Side setting is set to [Simplex]. On the scanner driver's [Basic] tab sheet, set [Scanning Side] to [Duplex]. If Scanning Side is set to [Skip blank page], images of blank pages are not saved.

Problem 9 A black margin appears around scanned document images.

Solutions A black margin appears when a document smaller than the preset papersize is scanned, or when the loaded document has shifted out of position. Make the following scanner driver settings.

- (1) On the [Basic] tab sheet, set the [Page Size] to [Match original size].
- (2) Adjust the margin setting in the minus direction ([Basic tab] – [Page Size] – [Page Size Settings] – [Scan Area] tab)
- (3) Enable [Border Removal] ([Image processing] tab – [Border Removal])

Problem 10 The scanned image is abnormal for certain documents.

Solutions A detection function such as border removal is enabled when scanning documents that include text or photos that extend to the edge of the page, preventing proper edge detection. When a page has text or photos extending to its edges, turn off the detection functions or scan that page individually.

Problem 11 The scanned image is abnormal in a particular application.

Solutions Some applications do not support functions such as auto-detection of page size, so scanning with such applications can produce abnormal scanned images. If abnormal image appearance seems to be application-dependent, try scanning with auto-detection disabled.

Problem 12 Pages are missing.

Solutions When the scanner driver's [Scanning Side] setting is [Skip Blank Page], documents with very little black may be unintentionally skipped. Decrease the Set the likelihood of skipping blank page value ("[When you want to delete the images of the blank pages in two-sided documents](#)" (See p. 82)) or set the [Scanning Side] to another mode, such as simplex or duplex. If pages are skipped due to the document double feeding, see "Problem 7 Documents jam (or double-feed)."

Problem 13 Documents are collectively fed

Solutions Click the [Advanced setting] button on the scanner driver's [Feeding] tab sheet, and check the [Increase separation force] checkbox in the [Advanced feed setting] dialog box. When setting in the User Mode, set [Separation Force] to [High Separation Mode]. "[User Mode Operations](#)" (See p. 60)
Also, make sure that the roller is installed correctly.

Problem 14 The scanner will multifeed documents.

Solutions

- (1) Check that the roller is installed correctly. Clean the roller if necessary.
- (2) The document will not scan correctly if it is stuck due to static electricity or for any other reason. Fan the document before placing it.

Problem 15 Paper jam occurs.

Solutions

- (1) Check that the roller is installed correctly.
- (2) If paper jams occur repeatedly, open the settings window of the scanner driver, and select [Extra-thin paper] for [Document type] in the [Feeding] tab. Alternatively, reduce the number of inputted documents to around 10.
- (3) If a paper jam occurs due to the curling of the ends of the document after replacing or cleaning the roller, perform 5 single scans of an A4-sized document.

Problem 16 Scanner does not feed document (or document has stopped in the feeding path).

- Solutions
- (1) If the continuous manual feeding mode is enabled, documents may not feed correctly. Disable the continuous manual feeding mode. "[Continuous manual feeding mode](#)" (See p. 45)
 - (2) Check that the roller is installed correctly. Clean the roller if necessary.

Problem 17 Multiple pages of scanned images cannot be saved to a single file.

Solutions Depending on the file format, multiple scanned image pages cannot be saved as a single file with CaptureOnTouch.

File type	Processing for multiple pages
BMP, JPEG	Scanned images are always saved one page per file.
PPTX	Multi-page images are always saved to a single file.
TIFF, PDF	You can save multiple pages to a single file by clicking  and selecting [Create 1 file for pages of a document] in the displayed dialog box.

Problem 18 All of the placed documents have been scanned, but the scanned image does not appear on the application.

Solutions When [Panel-Feeding] or [Automatic Feeding] is selected as the feeding method on the scanner driver's Detail Settings screen, a scanning operation will not continue after all of the documents are fed, as the scanner awaits additional documents to be fed. Pressing the Stop key on the operation panel terminates the scanning operation.

Problem 19 Memory becomes insufficient and scanning stops.

Solutions If you configure scanning conditions that use a large amount of the computer's memory, scanning may stop because of insufficient memory. Although this depends on the computer's memory size, the possibility of insufficient memory increases if any of the following scanning conditions overlap.

- [Color Mode] is set to [24-bit Color]
- A large page size is specified as the [Page Size]. Alternatively, the page size is set to [Scanner's Maximum].
- A high resolution (600dpi etc.) is specified for [Dots per inch].

If an error message appears due to insufficient memory while scanning is in progress, exit the application, change the scanning conditions (e.g. reduce the resolution or page size) and then try scanning again. In addition, the amount of memory used can be contained by turning off [Moire Reduction] and [Prevent Bleed Through/Remove Background] if they are set to on.

Problem 20 Multifeeding when scanning multiple bound pages.

Solutions Place the bound edge against the feed inlet and scan by manual feeding.

Problem 21 Barcode detection fails.

Solutions Barcode detection may fail depending on the brightness of the image. Adjust the [Brightness] setting on the [Brightness] tab sheet of the scanner driver's setting screen. Alternatively, enable [Prevent Bleed Through / Remove Background] on the [Image control] tab sheet. Alternatively, increase the [Dots per inch] setting on the [Basic] tab sheet.

Problem 22 Ejected documents are misaligned.

Solutions

- (1) Raise the Document Eject Stopper to stop ejected documents from spilling. ([See p. 43](#))
- (2) Lengthening the paper feed interval can make it easier to keep ejected documents aligned. Open the scanner driver's settings screen, and on the [Feeding] tab sheet, click the [Advanced setting] button and increase the [Feed interval setting]. ([See p. 26](#))
To set from User Mode, increase the [Feed Interval].
["User Mode Operations"](#) ([See p. 60](#))

- (3) Depending on document thickness and condition, extra time may be needed for documents to fall into the eject tray, causing them to be pushed out by subsequent ejected documents. In this case, open the scanner driver's settings screen and on the [Feeding] tab sheet, select [Extra-thin paper] for the [Document type].
To set from User Mode, set [Separation Force] to [Thin Paper Mode].
["User Mode Operations"](#) ([See p. 60](#))

Software Troubleshooting

This section describes troubleshooting problems and solutions for operating the supplied software (CaptureOnTouch).

If scanning is too slow

- (1) Close other running programs, if any.
- (2) Scanning can be slowed down by memory shortage caused by memory-resident applications such as anti-virus programs. Close such memory-resident programs if necessary to free up memory space.
- (3) When insufficient hard disk space is available, the scanner may be unable to create the necessary temporary files for scanned data. Delete unneeded data on the hard disk to free up more space.
- (4) Scanning is slow, if the computer's USB port is not compliant with high-speed standards such as Hi-Speed USB2.0 and USB3.1 Gen1.
- (5) If using a common USB cable that is not USB3.1 Gen1 compliant, replace the cable with the supplied compliant cable.
- (6) When the scanner is connected to the computer via a USB hub that is not USB3.1 Gen1 compliant, remove the hub and connect the scanner directly to the computer.

If scanned image files cannot be opened in an application

- (1) Scanned images saved as multi-page TIFF files can be opened only by programs that support this file format.
- (2) Images saved as compressed TIFF files (single- as well as multi-page) can only be opened by programs that support the compressed format. This happens when using applications that do not support CaptureOnTouch's TIFF file compression. In this case, select "None" as the image file compression format before scanning.

There is a display glitch on the UI screen of CaptureOnTouch.

Depending on the computer that you are using, a display glitch may occur on the UI screen when there are too many Scan mode panels, Select output panels, or Scanning Shortcut panels. Delete any panel that you will not use.

Useful tips

Here are some useful tips for scanning documents with CaptureOnTouch.

Where are scanned images saved? Can the save destination be changed?

Images are saved to the following locations, according to program settings.

Both Standard Scanning and Scanning Shortcut save the output to the destination set in the [Select output] panel.

All destination locations can be changed to other folders.

How are the scan settings configured?

By clicking the Edit button () in the [Select document] panel, you can edit the scan settings when the [Select document edit screen] opens.

How do I save multiple pages in one file, or save one file per page?

When scanned images are saved in BMP or JPEG format, each image is always saved in a separate file.

When scanned images are saved in PDF or TIFF format, you can specify multi- or single-page files. See also “Problem 18” in “Common Problems and Solutions”.

Can I copy or back up scanner setting configurations?

The setting configurations can be backed up and restored using [Back Up/Restore] on the [Basic settings] tab on the [Environmental settings] dialog box

How do I scan half-folded documents (folio scanning)?

Fold the document in half, and set it in the scanner with the fold at the right. Specify half-size document (the size after folding) and then scan. For details, see [p. 47](#).

How can I skip blank pages, and scan only non-blank pages?

Specify [Skip Blank Page] on the scanner driver setting screen, then scan.

How do I load and scan documents with mixed sizes?

Set [Page Size] to [Match original size] on the scanner driver setting screen, then scan. For details, see [p. 80](#).

What is the best way to scan business cards or photos?

Set [Page Size] to [Match original size] on the scanner driver setting screen, then scan. Alternatively, register the size of the cards or photos to be scanned. For details, see [p. 80](#).

How do I print scanned data?

- For both Standard Scanning and Scanning Shortcut, select [Print] in the [Select output] panel.
- To use this function, you need to install a plug-in.
- The plug-in can be installed by selecting its checkbox when installing CaptureOnTouch.

I want to save to other folders

- In CaptureOnTouch, destinations other than [Save to folder] are provided as a plug-in.
- By installing the plug-in, the scanned image can be printed, attached in an e-mail, or shared using various cloud services.
- The plug-in can be installed by selecting its checkbox when installing CaptureOnTouch.
- The available output destinations vary depending on the installed plug-in.

How can I attach scanned data to an e-mail (or send it as e-mail)?

- For both Standard Scanning and Scanning Shortcut, select [Attach to E-mail] in the [Select output] panel.
- To use this function, you need to install a plug-in.
- The plug-in can be installed by selecting its checkbox when installing CaptureOnTouch.

Paper Jam, Skew and Staple Detection Processing

When a paper jam, skew, or staple is detected, any documents remaining in the Eject Tray and scanner must be removed.

CAUTION

- Be careful removing any documents remaining inside the scanner. Otherwise, documents could be damaged or unexpected injury from paper cuts may occur.
- Remove all documents remaining inside the scanner. Any torn paper remaining inside may cause paper jams or breakdowns.

1 Remove any documents that have been left in the Eject Tray.

2 Open the upper unit smoothly. (See p. 106)

CAUTION

When opening and closing the upper unit, be careful not to get your fingers caught, as this may result in personal injury.

3 If any documents remain inside the scanner, remove them.

IMPORTANT

- With the upper unit slightly opened, remove any document that is partially ejected on the Eject Tray.
- Open the upper unit to the point where it stops, and remove the document remaining inside the scanner.

4 Smoothly close the upper unit. Further, press both ends of the upper unit to verify that it is securely closed. (See p. 107)

5 Check the last saved image, and try scanning again.

Return the document removed from inside the scanner to the top of the stack in the input tray, and press the Start key to resume scanning.

IMPORTANT

- Scanned images may not be saved even for documents ejected onto the Eject Tray. Be sure to check the last scanned image saved before scanning again.
- If a skewed document was detected, reload it straightly and scan again.
- If a staple was detected, remove the staple, reload the document, and scan again.

Error Message

When one of the following messages appears on the display panel, an error has occurred in the scanner. Follow the indicated procedure to resolve the error.

Message	Error Code	Problem	Solution
Scanner cover is open.	C001	The scanner's upper unit is open.	Close the upper unit.
	C009	The imprinter cover is open.	Close the imprinter cover.
A double paper-feed has occurred.	D002	A double feed was detected by the document length.	Remove the double fed document page(s), return them to the Document Feed Tray, and scan again.
	D004	A double feed was detected ultrasonically.	
Imprinter Insert Error	H001	An imprinter voltage error was detected.	Make sure that the ink cartridge is installed correctly.
	H004	No ink cartridge is installed in the imprinter.	Install an ink cartridge.
Staple detected	J001	A stapled document has been detected.	Remove the staple(s), and rescan the document.
Skewed document	J018	A skewed document was detected.	Remove and reposition the document page.
Dust detected	J050	Dust was detected on the scanning glass.	Clean the scanning glass.
Paper jammed in scanner.	P000	The document is jammed on the transport path.	Open the upper unit and remove the jammed paper.
	P001 P002	The document is jammed near the feed inlet.	
	P004 P006 P007	The document is jammed inside the scanner.	
	P010	It is possible that the multiple documents are jammed inside the scanner.	

Message	Error Code	Problem	Solution
The count does not match	U001	The specified count has not yet been reached.	Check the document count, and scan again.
	U002	Scanning finished without reaching the specified count.	
Scanner hardware problem.	Exxx	Internal scanner error.	Turn the power OFF, and restart the scanner. If this does not solve the problem, make a note of the error code, and contact your Canon service representative.

Uninstalling the Software

If the ISIS/TWAIN driver or CaptureOnTouch is not operating normally, uninstall the software by the following procedure. Then, re-install the software from the Setup disc. (See p. 9)

 **IMPORTANT**

Log on to Windows as an Administrator.

1 From the Windows task bar, click the [Start] button and then [Control Panel].

2 Click [Uninstall a program].
The [Uninstall or change a program] dialog box appears.

3 From the Programs list, select the software you want to remove and then click [Remove].
The delete confirmation screen appears.

4 Click [Yes].
Uninstallation of the software is now complete.

Specifications

Main Unit

Type	Desktop sheetfed scanner
Scannable Document	<p>Width: 50.8 to 305 mm (2" to 12.00")</p> <p>Length: 70 to 432 mm (Up to 5,588 mm (220") in Long Document Mode, or 3,000 mm (118") for DR-G2090)</p> <p>Thickness: Continuous Feeding: 20 g/m² to 209 g/m² (5 lb to 56 lb bond) (0.04 mm to 0.25 mm)</p> <p>Manual Feeding: 20 g/m² to 255 g/m² (5 lb to 64 lb bond) (0.04 mm to 0.3 mm)</p>
Document Feeding Methods:	Continuous Feeding, Manual Feeding, and Continuous Manual Feeding
Load Capacity	<p>500 sheets (80 g/m² paper, DR-G2090: 300 sheets)</p> <p>Sizes larger than A4: Maximum 200 sheets (80 g/m² paper)</p> <p>Maximum loading height: 48 mm (1.89")</p>
Scanning Sensor	Contact image sensor
Light source	LED
Scanning Sides	Simplex, Duplex, Skip blank pages
Scanning Modes	Black and White, Error Diffusion, Advanced Text Enhancement, Advanced Text Enhancement II, Active Threshold, 256-level Grayscale, and 24-bit Color

Scanning Resolution

			100, 150, 200, 240, 300, 400 and 600 dpi	
Scanning Speed (A4 landscape)				* Reference Value
DR-G2140	Grayscale	Simplex	200 dpi	145 sheets/min.
			300 dpi	145 sheets/min.
		Duplex	200 dpi	290 images/min.
	Color	Simplex	300 dpi	290 images/min.
			200 dpi	145 sheets/min.
		Duplex	300 dpi	145 sheets/min.
DR-G2110	Grayscale	Simplex	200 dpi	120 sheets/min.
			300 dpi	120 sheets/min.
		Duplex	200 dpi	240 images/min.
	Color	Simplex	300 dpi	240 images/min.
			200 dpi	120 sheets/min.
		Duplex	300 dpi	120 sheets/min.
DR-G2090	Grayscale	Simplex	200 dpi	240 images/min.
			300 dpi	100 sheets/min.
		Duplex	200 dpi	100 sheets/min.
	Color	Simplex	300 dpi	200 images/min.
			200 dpi	100 sheets/min.
		Duplex	300 dpi	200 images/min.

Scanning Speed (LTR landscape)

DR-G2140	Grayscale	Simplex	200 dpi	140 sheets/min.	
			300 dpi	140 sheets/min.	
		Duplex	200 dpi	280 images/min.	
	Color	Simplex	300 dpi	280 images/min.	
			200 dpi	140 sheets/min.	
		Duplex	200 dpi	280 images/min.	
300 dpi			280 images/min.		
DR-G2110		Grayscale	Simplex	200 dpi	110 sheets/min.
				300 dpi	110 sheets/min.
	Duplex		200 dpi	220 images/min.	
	Color	Simplex	300 dpi	220 images/min.	
			200 dpi	110 sheets/min.	
		Duplex	200 dpi	110 sheets/min.	
300 dpi			110 sheets/min.		
DR-G2090		Grayscale	Simplex	200 dpi	90 sheets/min.
				300 dpi	90 sheets/min.
	Duplex		200 dpi	180 images/min.	
	Color	Simplex	300 dpi	180 images/min.	
			200 dpi	90 sheets/min.	
		Duplex	300 dpi	90 sheets/min.	
200 dpi			90 sheets/min.		
Others		Double-Feed Detection, Deskew, User Mode, Long Document Mode, and Folio Scan			

External Dimensions

	480 (W) × 569 (D) × 315 (H) mm
	18.9" (W) × 12.4" (D) × 12.4" (H)
Maximum External Dimensions (with Document Feeder Tray/Wire Extensions, Document Eject Tray Extension, and Eject Paper Stopper open)	
	480 (W) × 723 (D) × 390 (H) mm
	18.9" (W) × 28.5" (D) × 15.4" (H)
Weight	Approx. 25.0kg (55.1 lbs)
Power Supply	
	120 V model
	AC 120 V (60 Hz), 0.7 A
	220-240 V model
	AC 220-240 V (50/60 Hz), 0.4 A
Power Consumption	
	Scanning: 66.5 W
	Stand-by Mode (Sleep Mode): 3.5 W
Noise	Not more than 54 dB
Operating Environment	
	Temperature: 10°C to 35°C (50°F to 95°F)
	Humidity: 20% to 80% RH
Specifications are subject to change without notice due to product improvements.	

Options

Imprinter Unit (product code: 3601C001)

The imprinter unit prints a text string on scanned document pages.

Carrier sheet (product code: 0697C001)

This is a carrier sheet for scanning documents without damaging the documents.

White Platen Roller (product code: 3601C004)

This platen roller option can be used to obtain a white background in scanned images.

Flatbed Scanner Unit 102 (product code: 2152Cxxx)

Flatbed scanner unit that can be connected to and used with a DR scanner. Connecting the unit to this scanner enables you to use this scanner as a flatbed scanner with an automatic document feeder.

Flatbed Scanner Unit 201 (product code: 6240Bxxx)

A flatbed scanner unit that can be used by connecting to a DR scanner and supports A3 size paper. Connecting the unit to this scanner enables you to use this scanner as a flatbed scanner with an automatic document feeder.

Consumables

Exchange roller kit (product code: 3601C002)

Replacement kit for transport rollers (pick-up roller, feed rollers, and retard roller). ["Replacing the Feed Roller"](#) (See p. 110)

Separation Pads (product code: 3601C005)

IMPORTANT

- Rollers and separation pads are consumable parts. When the rollers and separation pads start to wear out, problems such as paper jams and improper document feeding are more likely to occur. In this case, replace the rollers and separation pads regardless of the page count of the roller usage counter.
- For details about the Exchange Roller Kit and Separation Pads, contact your local authorized Canon dealer or service representative.

Ink Cartridge: Blue (product code: 3693A002)

This blue ink cartridge is used by the imprinter. ["Replacing Ink Cartridges"](#) (See p. 122)

Ink Cartridge: Red (product code: 3693A003)

This red ink cartridge is used by the imprinter.

Cleaning Sheet (product code: 2418B002)

This cleaning sheet is for cleaning the feed rollers. ["Feed Cleaning Sheet"](#) (See p. 70)

Dimensions

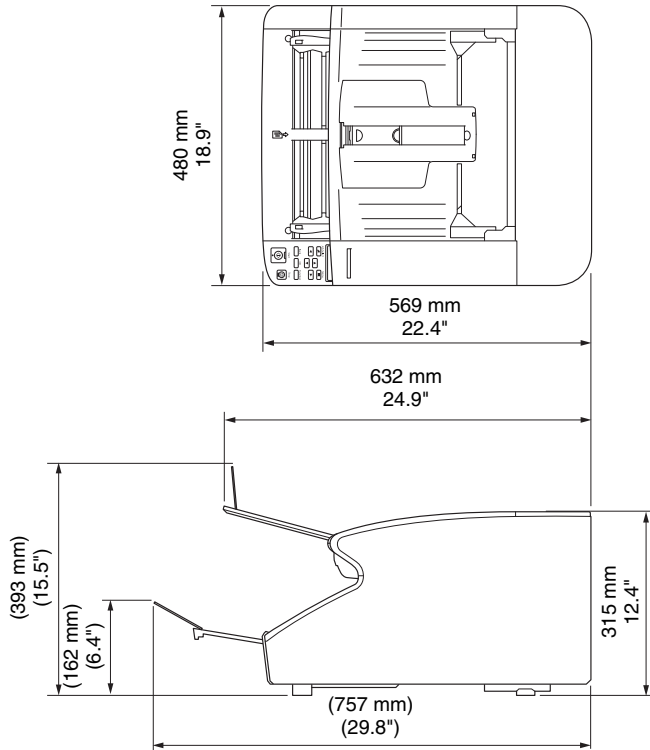

Other Specifications

This section describes the specifications for the separately sold ([See p. 143](#)) Imprinter products. Refer to "Batch Separation Using Patch Code Sheets" ([See p. 93](#)) for the specifications of the patchcodes that can be detected by the patchcode decoder.

Imprinter Specifications

Printing Side	Front
Position	Horizontal: adjust by moving the carriage left or right (13 places) (See p. 125) Vertical: set by the ISIS/TWAIN driver
Printing Content	Set by the ISIS/TWAIN driver
Printing Font	12 × 12 or 12 × 8 dots
Inter-Character Setting	Yes (set by the ISIS/TWAIN driver)
Printable Digits	Up to 32 characters
Printable Paper	Plain paper without water-repellent treatment
Ink Cartridge	HP Ink Cartridge Colors: blue or red (See p. 122)
Image Density	12 nozzles/oblique line (96 dpi)
Ink	Water based

Index

A		
Auto Power Off	109	
B		
Batch Separation	85, 92	
C		
CaptureOnTouch	75	
Carrier sheet	49	
Cleaning Cloth	105	
Connecting to a Computer	11	
Counter	111	
Count-Only Mode	56	
D		
Daily Maintenance	105	
Glass	107	
Main Unit	105	
Power Plug	109	
Roller	107	
Sensor	106	
Detaching and attaching the separation pad (retard roller cover)	120	
Disposal	22	
Document Eject Stopper	43	
Document Eject Tray	42	
Document Eject Tray Extension	43	
Document Feed Tray	36	
Document Feed Tray Extension	39	
Document Feeding Method		
Continuous Feeding	44	
Manual feed mode (continuous)	45	
Manual Feeding	44	
Document Feeding Methods	44	
Document Guides	38, 42	
Adjustment	39	
Documents	34	
Double Feed Detection	53, 66, 68, 84	
E		
Error message	138	
F		
Flatbed Scanner Unit 102	143	
Flatbed Scanner Unit 201	143	
Folio Scan	47	
Function Key	31, 58	
H		
Head Cleaning	128	
I		
Important Safety Instructions	19	
Imprinter	122	
Cleaning	126	
Cover	122	
Test Printing	127	
Ink Cartridge	122	
Cleaning	127	
Replace	122	
Installation Location	19	

Installing	8	Scanner driver	76
J		Basic settings	79
Job function	73	Settings suitable for intended use	82
L		Scanner models	5
Long Document Mode	50	Staple Detection	67, 69
M		System requirements	8
Moving the Scanner	20	T	
Multistream Settings	86	Troubleshooting	129
N		U	
Names and Functions of Parts	28	Uninstall	140
Network	71	Upper Unit	106
O		User Mode	60
Operation Panel	30	Operating Procedure	60
P		User Mode Functions	65
Patchcode pattern	93	V	
Patchcode sheet	93	Verify Count	56
Power Supply	20	Verify Scan	56
R		W	
Rapid Recovery System	53	Web Menu	98
Replacing the Feed Roller	110	Settings	101
Replacement Time	110		
Roller Replacement Kit	111		
Routine Precautions	20		
S			
Scan	73		
Scan by Job Selection	73		
Scan with CaptureOnTouch	75		

Safety-related markings on the machine

Marquages de sécurité sur la machine

Marcature di sicurezza sulla macchina

Sicherheitshinweise auf der Maschine

Marcas de la máquina relacionadas con la seguridad

Veiligheidsmarkeringen op de machine

Makine üzerindeki güvenlik işaretleri



[English]	Switch (On)	Power on
[Français]	Commutateur (Marche)	Sous tension
[Italiano]	Interruttore (On)	Alimentazione presente
[Deutsch]	Schalter (Ein)	Eingeschaltet
[Español]	Interruptor (encendido)	Máquina encendida
[Nederlands]	Schakelaar (On)	Aan
[Türkçe]	Anahtar (Açık)	Güç açık



[English]	Switch (Off)	Power off (no standby current)
[Français]	Commutateur (Arrêt)	Hors tension (pas de courant de veille)
[Italiano]	Interruttore (Off)	Alimentazione assente (nessuna corrente di standby)
[Deutsch]	Schalter (Aus)	Ausgeschaltet (ohne Ruhestromaufnahme)
[Español]	Interruptor (apagado)	Máquina apagada (sin corriente en espera)
[Nederlands]	Schakelaar (Off)	Uit (geen stand-byverbruik)
[Türkçe]	Anahtar (Kapalı)	Güç kapalı (bekleme akımı yok)



[English]	Switch (Standby)	Power on/off (standby current on)
[Français]	Commutateur (Veille)	Sous/hors tension (courant de veille activé)
[Italiano]	Interruttore (Standby)	Alimentazione on/off (corrente di standby presente)
[Deutsch]	Schalter (Standby)	Ein- und Ausschalten (mit Ruhestromaufnahme)
[Español]	Interruptor (en espera)	Máquina apagada/encendida (con corriente en espera)
[Nederlands]	Schakelaar (Standby)	Aan-uit (stand-byverbruik aan)
[Türkçe]	Anahtar (Bekleme)	Güç açık/kapalı (bekleme akımı açık)



[English]	Switch (Push-On/Push-Off)	Power on/off (no standby current)
[Français]	Commutateur (Appuyer pour mettre en marche/Appuyer pour arrêter)	Sous/hors tension (pas de courant de veille)
[Italiano]	Interruttore a pulsante bistabile (On/Off)	Alimentazione on/off (nessuna corrente di standby)
[Deutsch]	Schalter (Ein- und Ausschalten durch Drücken)	Ein- und Ausschalten (ohne Ruhestromaufnahme)
[Español]	Interruptor (pulsado para encendido/apagado)	Encendido/apagado (sin corriente en espera)
[Nederlands]	Schakelaar (Push-On/Push-Off)	Aan-uit (geen stand-byverbruik)
[Türkçe]	Anahtar (Bas-Aç/Bas-Kapa)	Güç açık/kapalı (bekleme akımı yok)



[English]	Heat hazard	Heat hazard
[Français]	Danger de chaleur	Danger de chaleur
[Italiano]	Pericolo: temperature elevate	Pericolo: temperature elevate
[Deutsch]	Überhitzungsgefahr	Überhitzungsgefahr
[Español]	Peligro de calentamiento	Peligro de calentamiento
[Nederlands]	Verbrandingsgevaar	Verbrandingsgevaar
[Türkçe]	Isı tehlikesi	Isı tehlikesi



[English]	Class II equipment	Indicates this is Class II equipment
[Français]	Équipement de classe II	Indique qu'il s'agit d'un équipement de classe II
[Italiano]	Apparecchio classe II	Indica che questo è un apparecchio di classe II
[Deutsch]	Gerät der Schutzklasse II	Gibt an, dass das Gerät der Schutzklasse II entspricht
[Español]	Equipo de clase II	Indica que se trata de un equipo de clase II
[Nederlands]	Klassell-apparaat	Geeft aan dat deze apparaat in Klasse II hoort
[Türkçe]	Sınıf II ekipman	Bunun Sınıf II ekipman olduğunu gösterir



[English]	DC symbol	Indicates direct current
[Français]	Symbole CC	Indique qu'il s'agit de courant continu
[Italiano]	Simbolo corrente continua (C.C.)	Indica la corrente continua
[Deutsch]	Gleichstrom-Symbol	Kennzeichnet Gleichstrom
[Español]	Símbolo CC	Indica corriente continua
[Nederlands]	DC-pictogram	Geeft gelijkstroom aan
[Türkçe]	DC sembolü	Düz akımı gösterir



[English]	DC polarity	Indicates the power plug polarity
[Français]	Polarité CC	Indique la polarité de la fiche d'alimentation
[Italiano]	Polarità C.C.	Indica la polarità dello spinotto di alimentazione
[Deutsch]	Gleichstrompolarität	Gibt die Polarität des Netzsteckers an
[Español]	Polaridad de CC	Indica la polaridad del conector de alimentación
[Nederlands]	DC-polariteit	Geeft de polariteit van de stekker aan
[Türkçe]	DC polaritesi	Fiş polaritesini gösterir



[English]	Electrostatic precaution	Avoid applying static electricity to the machine
[Français]	Précaution électrostatique	Évitez de soumettre cette machine à de l'électricité statique
[Italiano]	Protezione dalle cariche elettrostatiche	Evitare di applicare cariche elettrostatiche alla macchina
[Deutsch]	Warnung vor elektrostatischer Aufladung	Elektrostatische Aufladung der Maschine vermeiden
[Español]	Precaución electroestática	No aplique electricidad electroestática
[Nederlands]	Elektrostatische voorzorgen	Voorkom statische elektriciteit op de machine
[Türkçe]	Elektrostatik önlemleri	Makineye statik elektrik vermeyin



CANON ELECTRONICS INC.

3-5-10 SHIBAKOEN, MINATO-KU, TOKYO 105-0011, JAPAN

CANON U.S.A. INC.

ONE CANON PARK, MELVILLE, NY 11747, U.S.A.

CANON CANADA INC.

8000 MISSISSAUGA ROAD, BRAMPTON, ONTARIO L6Y 5Z7, CANADA

CANON EUROPA N.V.

BOVENKERKERWEG 59, 1185 XB AMSTELVEEN, THE NETHERLANDS

CANON AUSTRALIA PTY. LTD.

BUILDING A, THE PARK ESTATE, 5 TALAVERA ROAD, MACQUARIE PARK, NSW 2113, AUSTRALIA

CANON SINGAPORE PTE. LTD.

1 FUSIONPOLIS PLACE, #15-10, GALAXIS, SINGAPORE 138522

CANON KOREA BUSINESS SOLUTIONS INC.

BS TOWER, 607 TEHERAN-RO, GANGNAM-GU, SEOUL, KOREA

CANON INDIA PVT. LTD

7TH FLOOR, TOWER B DLF CYBER TERRACES DLF PHASE III GURGAON - 122002 HARYANA, INDIA

PUB. 6T3-0034-E1.20

© CANON ELECTRONICS INC. 2018

Free Manuals Download Website

<http://myh66.com>

<http://usermanuals.us>

<http://www.somanuals.com>

<http://www.4manuals.cc>

<http://www.manual-lib.com>

<http://www.404manual.com>

<http://www.luxmanual.com>

<http://aubethermostatmanual.com>

Golf course search by state

<http://golfingnear.com>

Email search by domain

<http://emailbydomain.com>

Auto manuals search

<http://auto.somanuals.com>

TV manuals search

<http://tv.somanuals.com>