

# DIGITAL VIDEO CAMCORDER

# Instruction Manual

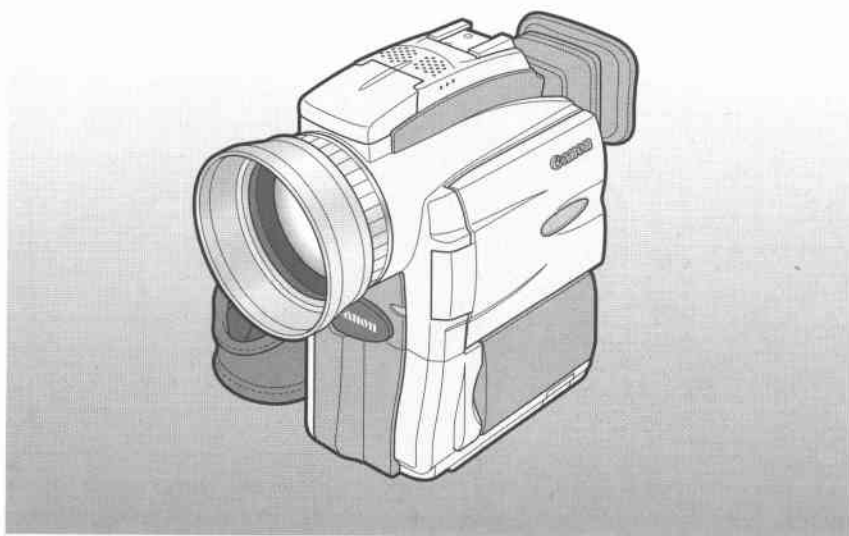

# Canon

## *MVX1/MVX1i*

MiniDV Digital  
Video  
Cassette

This instruction book explains the use of the MVX1 and MVX1i camcorders. The main difference between these models is that the MVX1i includes a DV Recording and Analog Line-in Recording function. Please note that illustrations and explanations in this instruction book refer mainly to the MVX1 model.

**PAL**

**E**

Introduction

Mastering  
the BasicsUsing the Full  
Range of Features

Editing

Using a Memory Card

Additional  
Information

## Contents, cont.

**E**

Introduction

### Using a Memory Card

Memory Card Introduction .....	103
Recording Still Images to a Memory Card .....	107
Recording an Image from a Cassette as a Still Image .....	109
Recording from Another DV Device as a Still Image (MVX1i only) .....	110
Viewing Still Images .....	111
Setting of the Still Image recorded to a memory card .....	113
Preventing Accidental Erasure (Protect) .....	116
Marking a Still Image for Printing (Print Mark) .....	117
Erasing Still Images .....	119
Combining Images and Recording Them to a Cassette (Title Mix) .....	121





Copying Still Images from a Cassette .....	125
Copying Memory Card Still Images to a Cassette .....	126
Formatting a Memory Card .....	127
Other Information and Precautions .....	128

### Additional Information







Preparing the Camcorder .....	131
Notes on Using the Batteries .....	133
Maintenance .....	136
Troubleshooting .....	140
The MVX1/MVX1i System Diagram .....	144
Optional Accessories .....	145
Screen Displays .....	148
Specifications .....	155
Index .....	157
Menu at a Glance .....	160

### For quick reference

In addition to the contents and index please refer to:

- Finding Your Way Around the MVX1/MVX1i (  7)
- Screen displays (  148)
- Troubleshooting — in case you run into any problems (  140)
- Menu at a Glance (  160)

Symbols used in this instruction manual:

-  : Reference page numbers
-  : Functions that can be operated from the body of the camcorder
-  : Functions that can be operated from the wireless controller
-  : Supplementary notes for camcorder operation
-  : Operation confirmation beeps (  21)

- Capital letters are used to refer to settings displayed in the menus and buttons labelled on the camcorder itself, e.g. Press the MENU button.

# Thank you for Choosing a Canon

First, we'd like to thank you for purchasing this Canon camcorder. Its advanced technology makes it very easy to use — you will soon be making high-quality videos which will give you pleasure for years to come.











To get the most out of your new camcorder, we recommend that you read this manual thoroughly — there are many sophisticated features which will add to your recording enjoyment.

## Getting started

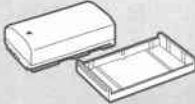
To get started we suggest that you master the basic operations of the camcorder first, before moving on to use its full range of features.

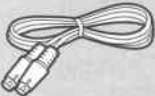
- When connecting the camcorder to your personal computer, use the optional CV-150F or CV-250F DV cable.

Your camcorder is supplied with the following accessories:

WL-D77 Wireless Controller 	Two AA batteries 
Lens hood 	Lens cap and lens cap cord 
BP-512 Battery Pack 	CA-560 Compact Power Adapter (including AC power cable) 
Lithium button battery 	S-150 S-video Cable 
STV-250N Stereo Video Cable 	PC-A10 SCART Adapter (Europe, Asia) 
MMC-8M MultiMediaCard (with pre-recorded sample images) 	Soft case for MultiMediaCard 

# Introducing the MVX1/MVX1i

E

Introduction

## Mega-pixel CCD

Your camcorder incorporates a 1.33 mega-pixel CCD. High-resolution still images can be recorded to a memory card.

## Built-in Flash



The built-in flash automatically rises up and fires according to the brightness of the surrounding area.

## IEEE 1394 DV Terminal



Using a DV cable, connect the MVX1/MVX1i to a PC equipped with a DV terminal and transfer your original images and sound to your PC.

## Extended Recording Time Function

Record for 1.5 $\times$ , 2 $\times$  or 3 $\times$  longer than when in SP mode— up to 4 hours on an 80 minute tape.

## Memory Card

Record, manage and store still images on a MultiMediaCard or an SD Memory Card. Recorded images can be immediately checked by the press of a single button, allowing you to erase them or set protection. Combine still images recorded on the card with your original movies or still images. Also great for easy transfer of still images to a PC.

## Tilt-up Viewfinder & Rotative Grip Belt



Tilting viewfinder and rotating grip belt will make recording more flexible and stable.

## Still Photos



Just press the photo button to capture still pictures. You can record vivid still images onto a memory card with the incorporated mechanical shutter. (Progressive Photo)

## 2.5" LCD Screen

## Optical Image Stabilizer



Canon's optical technology stabilizes your recordings even in long telephoto shots.

## 10 $\times$ (Card 8 $\times$ ) Lens and 40 $\times$ /200 $\times$ Digital Zoom

## Advanced Accessory Shoe

Allows the Canon Video Light VL-3 or the Directional Stereo Microphone DM-50 (both optional) to be easily attached and powered by the camcorder's own power source.

## Digital Effects



Advanced digital technology allows you to add special effects during recording. Display 4, 9 or 16 still images at once with the multi-image screen.

## Audio Dubbing

## Analog Line-in Recording and AV Insert Editing (MVX1i only)

Connect to a VCR or analog camcorder and record to a DV tape in the MVX1i. Also, replace original images and sound on a pre-recorded tape.

# Finding Your Way Around the MVX1/MVX1i

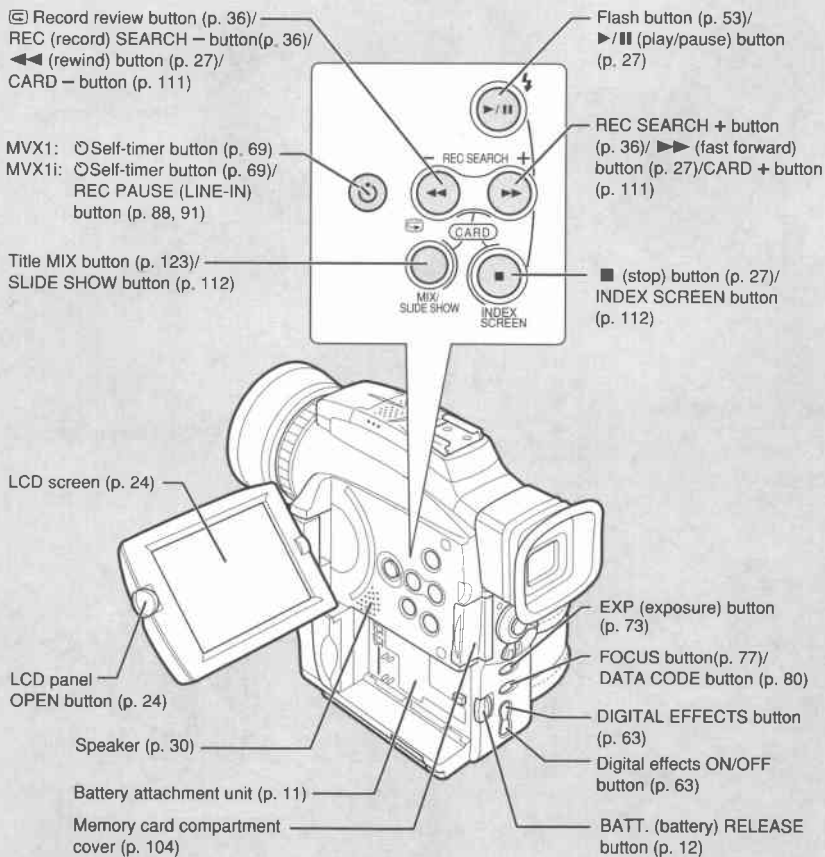

Advanced accessory shoe  
(p. 71, 72)

Viewfinder (p. 131, 137)

Viewfinder focusing  
lever (p. 131)



Stereo microphone  
(p. 95, 97)

PHOTO button  
(p. 51, 107)

Zoom controller (p. 22)

MENU button (p. 38)

MIC terminal  
(p. 67, 95, 98)

Selector dial (p. 30, 38)

Program selector (p. 56)

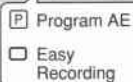

Card access  
indicator (p. 107)

Start/Stop button  
(p. 18)

TAPE/CARD switch  
(p. 17)

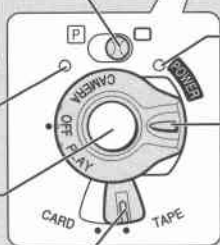

POWER indicator  
(p. 17)

POWER switch  
(p. 17)

Grip belt (p. 132)

Bottom view

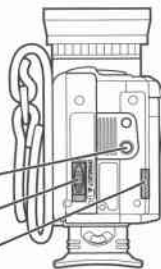

Tripod socket (p. 34)

OPEN/EJECT switch (p. 15)

Backup battery holder (p. 135)

MVX1  
CAMERA  
OFF  
PLAY



MVX1i  
CAMERA  
OFF  
PLAY(VCR)



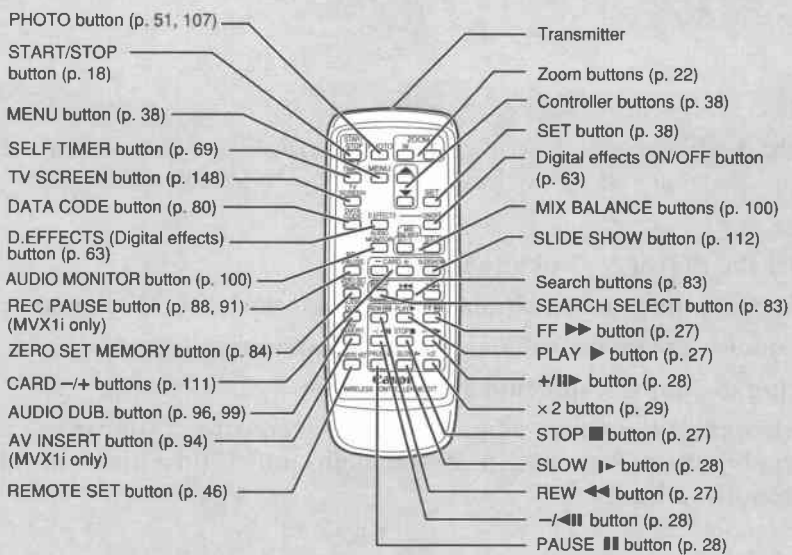
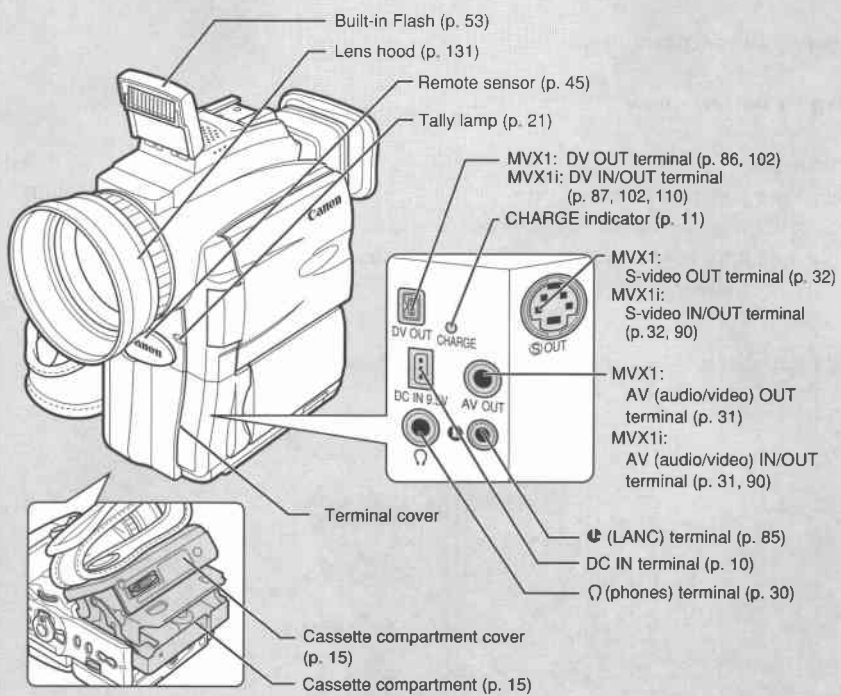

## Powering Your Camcorder

Before operating your camcorder, you will need to use the power adapter to to:

E

**Provide power from a mains outlet**

or

**Charge a battery pack**

### **Notes:**

- The power adapter converts current from a household power socket (100–240 V AC, 50/60 Hz) to the DC current used by your camcorder.
- If the adapter is used next to a TV, it may cause bars to appear on the TV — move the adapter away from the TV or the aerial cable.

### Connecting the camcorder to a mains outlet

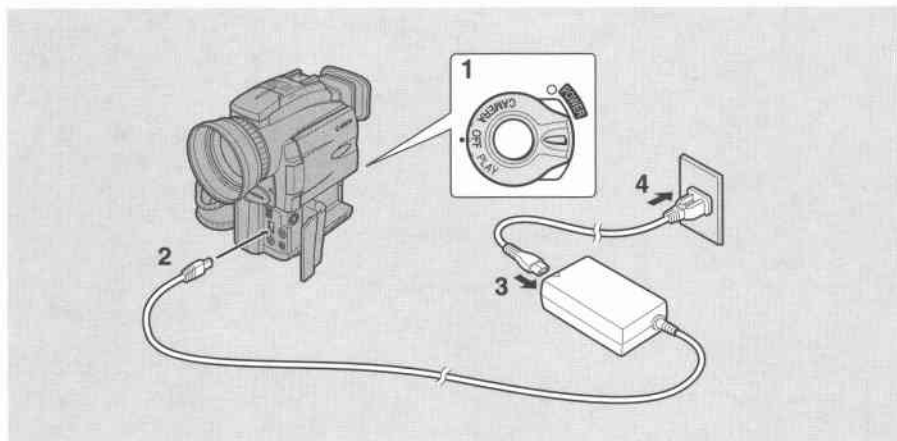

Use the power adapter to provide your camcorder with instant power from a mains outlet. Always turn the camcorder off before connecting/removing the power source.

1. Set the **POWER** switch to **OFF**.
2. Connect the power adapter to the camcorder's **DC IN** terminal.
3. Connect the power cable to the power adapter.
4. Plug the power cable into a mains outlet.
5. Disconnect the power adapter from the camcorder after use.  
Unplug the power cable from the mains outlet, then disconnect it from the adapter.



## Attaching and charging the battery packs

E

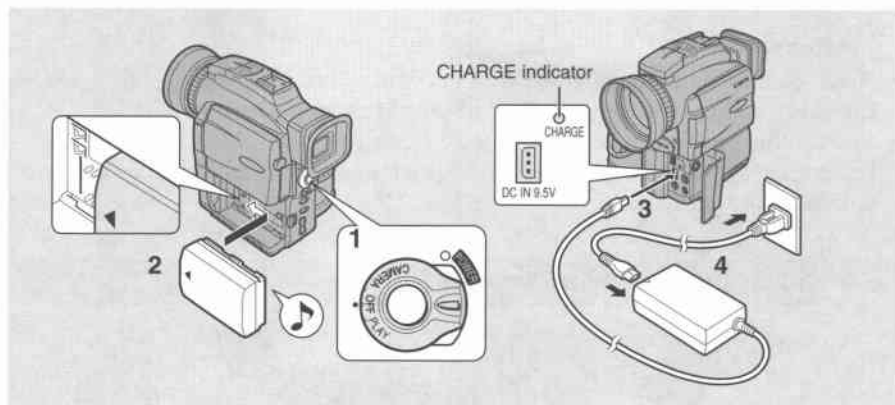

Mastering  
the Basics

Your battery pack was partially charged before it left the factory. It should have enough power for you to check that your camcorder is working properly. However, you must charge the battery pack fully if you want it to power the camcorder for more than a few minutes.

Always turn the camcorder off before connecting/removing the battery.

- 1. Set the POWER switch to OFF.**
- 2. Attach the battery to the camcorder.**
  - Remove the battery pack's terminal cover.
  - Align the edge of the battery pack with the line on the camcorder, press lightly and slide the battery down until it clicks into place.
- 3. Connect the power adapter to the camcorder.**
- 4. Connect the power cable to the adapter and plug it into a mains outlet.**
  - The charge indicator flashes red to show that charging is in progress. Single flashes mean that the battery pack is less than 75% charged. Double flashes mean that it is more than 75% charged. The indicator glows steadily when the battery pack is fully charged. If the indicator blinks rapidly and continuously (twice a second), the battery pack may be defective.
  - The battery pack will also charge when the POWER switch is turned to positions other than OFF. The CHARGE indicator may both flash or stay lit.
- 5. When charging is complete, disconnect the power adapter from the camcorder. Unplug the power cable from the mains outlet, then disconnect it from the adapter.**

## 6. Remove the battery pack after use.

- Press the BATT. RELEASE button and remove the battery.



### Notes:

- Never connect an unspecified product to the camcorder's DC terminal. Likewise, do not connect the power adapter to an unspecified product.
- You can find detailed notes for using the batteries in the "Notes on Using the Batteries" (□ 133). These notes include charging and recording times and how to install the backup battery.

### CA-560 Compact Power Adapter

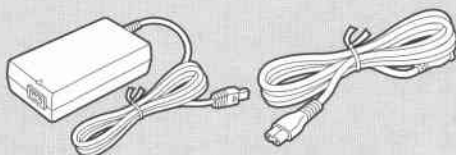

### Specifications

<b>Power supply</b>	100–240 V AC, 50/60 Hz
<b>Power consumption</b>	34 W
<b>Rated output</b>	9.5 V, 2.7 A DC
<b>Operating temperature range</b>	0°C–40°C (32°F–104°F)
<b>Dimensions</b>	57 × 28 × 104 mm (2 1/4 × 1 1/8 × 4 1/8 in)
<b>Weight</b>	180 g (6 3/8 oz) (without power cable)

Weight and dimensions are approximate.  
 Errors and omissions excepted.  
 Subject to change without notice.

## Using the Charge Adapter CR-560 Kit (optional)

The Compact Power Adapter CA-560 included with the camcorder can be used along with the CR-560 Kit for 3 different ways to power the camcorder or charge battery packs:

1. Charge the BP-500 Series battery packs with power from your car battery.
2. Operate the camcorder with power from your car battery.
3. Charge the BP-500 Series battery packs from a household mains outlet.

The Charge Adapter/Car Battery Cable Kit CR-560 includes the following:

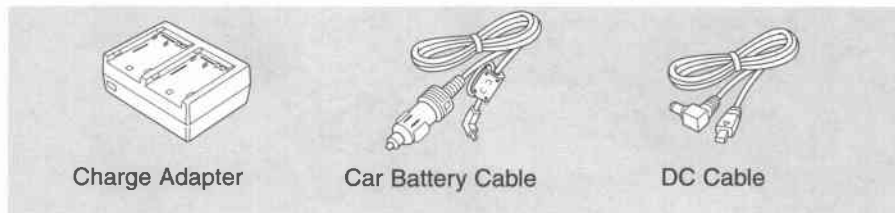

Charge Adapter

Car Battery Cable

DC Cable

### 1. Charge the BP-500 Series battery packs with power from your car battery.

1 or 2 battery pack(s) + Charge Adapter + Car Battery Cable → car's cigarette lighter

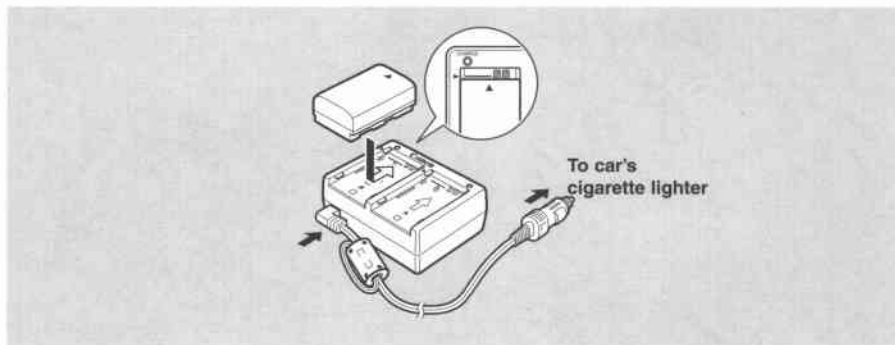

- Fast charging for the high-capacity BP-522 and BP-535 (both optional). Fifteen minutes of charging gives 60 minutes of recording (using the viewfinder).

	Time required for full charge from car battery or household outlet
BP-512	1 hr. 20 min.
BP-511 (optional)	1 hr. 20 min.
BP-522 (optional)	1 hr. 40 min.
BP-535 (optional)	2 hr. 30 min.

## 2. Operate the camcorder with power from your car battery.

Camcorder + DC Cable + Charge Adapter + Car Battery Cable → car's cigarette lighter

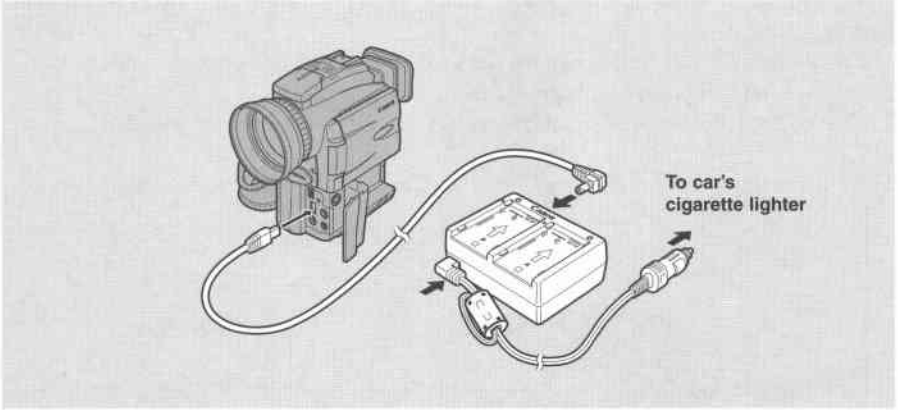

## 3. Charge the BP-500 Series battery packs from a household mains outlet.

1 or 2 battery pack(s) + Charge Adapter + Compact Power Adapter

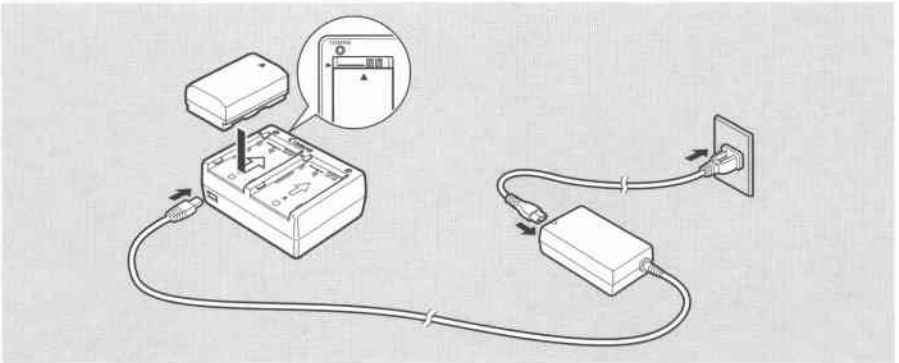

- Fast charging for the high-capacity BP-522 and BP-535 (both optional). Fifteen minutes of charging gives 60 minutes of recording (using the viewfinder).



### Note:

- For full details of how to use the CR-560, refer to its instruction manual.

## Loading a Cassette

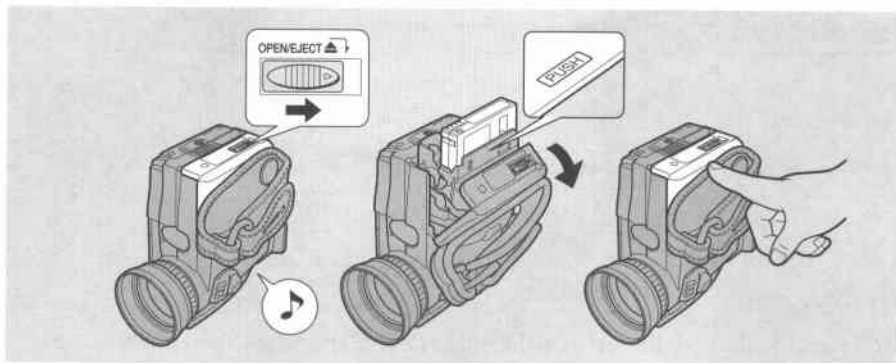



Only use videocassettes marked with the <sup>Mini</sup> DV logo.\*

### Loading and unloading

1. Make sure that you have attached a power source.
2. Slide the **OPEN / EJECT** ▲ switch (on the bottom of the camcorder) to release the cassette compartment cover.
  - Pull the cover fully open (while holding the button) and wait a couple of seconds for the cassette compartment to open automatically.
  - The confirmation beep sounds when the cassette cover fully opens.
3. Load or unload the cassette.
  - Insert the cassette gently with the window facing the grip belt, and the REC/SAVE tab outwards.
  - Remove the cassette by pulling it straight out.
4. Press the **PUSH** mark on the compartment until it clicks, and wait for it to close.
5. Click the cover back into place.

\* <sup>Mini</sup> DV is a trade mark.



#### Notes:

- Do not interfere with the cassette compartment while it is opening or closing automatically, and do not attempt to close the cover until the cassette compartment has fully retracted.
- After loading a cassette, use record search (  36) to find the point where you want to start recording.
- Be careful not to get your fingers caught in the cassette compartment cover.
- Do not leave the cassette in the camcorder after use — return it to its case and store it in a cool, clean, dry place.
- When you turn the camcorder's power on,  flashes in the display until you load a cassette.
- With some types of tapes, the remaining tape display may not give an accurate reading (  149).

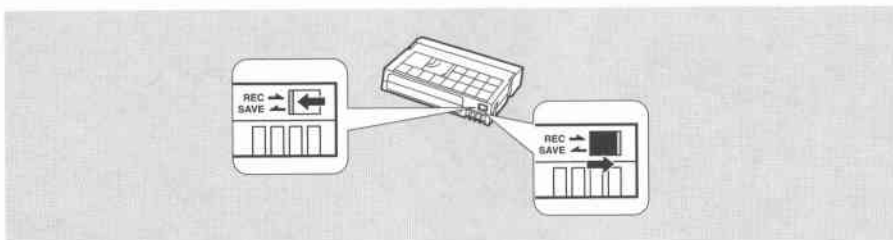
## Protecting tapes from accidental erasure



To protect your recording from accidental erasure, slide the tab on the cassette so that it exposes the hole. (This switch position is usually labelled SAVE or ERASE OFF.)

If you load this cassette and put the camcorder in record pause mode (  17), “THE TAPE IS SET FOR ERASURE PREVENTION” is displayed for approx. 4 seconds and then the  mark flashes in the display.

If you want to record on the cassette again, slide the tab back so the hole is closed.

## Handling cassettes

- To protect the tape heads, transfer cassettes directly from the tape case to the camcorder — do not open the tape protect cover or touch the tape itself.
- Do not use cassettes where the tape has been damaged or spliced — they may damage the camcorder.
- Do not insert anything into the small holes on the cassette or cover them with cellophane tape.
- Handle cassettes with care — dropping them or exposing them to external shocks may cause internal damage.
- Store cassettes in the provided case, first rewinding them to the start of the tape and then storing them upright.
- A cassette with metal plated terminals may become dirty with use, affecting information transfer. Therefore, after using a tape about 10 times, be sure to clean the terminals with a cotton bud.

## Cassette memory

You are unable to use the cassette memory function with this camcorder.

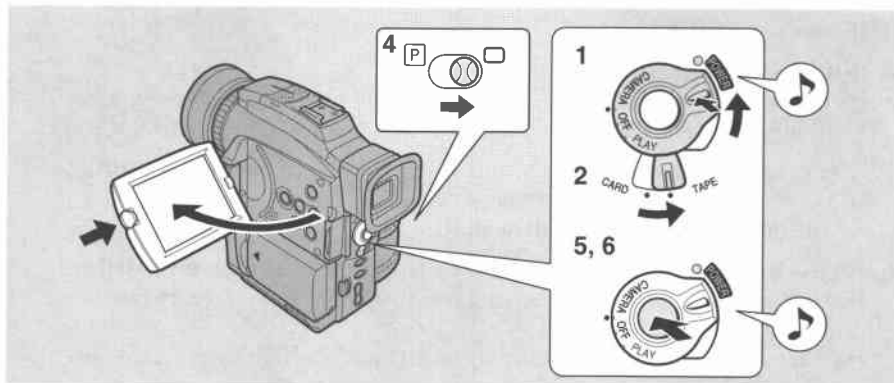

## Before you start recording

Have you completed the following steps?

- Attached a power source (□ 10).
- Removed the lens cap (□ 132).
- Fasten the grip belt (□ 132).
- Attach the lens hood (□ 131).
- Chosen the display: viewfinder (□ 131) or LCD screen (□ 24).



### Note:

- When you're using the viewfinder, fully close the LCD or rotate the LCD so that it faces the same direction as the lens (□ 24).

You may also want to install the backup battery (□ 135) in order to set the date and time display (□ 48).

## To record

- 1. Press the small green button on the POWER switch and hold, turn the POWER switch to CAMERA.**
  - The camcorder automatically sets to record pause mode. PAUSE appears in the display.
  - If you haven't set the date and time display, SET THE TIME ZONE, DATE AND TIME appears in the display. For setting the time zone, see p. 48. For setting the date and time, see p. 50.
  - The camcorder power indicator lights up red.
  - The confirmation beep sounds.
  - The camcorder will turn itself off if you leave it in record pause mode for more than about 5 minutes. To return to record pause mode, turn the POWER switch to OFF and then back to CAMERA.
- 2. Make sure the TAPE/CARD switch is set to TAPE.**
  - For still image recording to a memory card, see p. 107.

3. Load a cassette (  15).
4. Slide the program selector to .
  - This selects the camcorder's Easy Recording program. It allows you to simply point and shoot without making any manual adjustments (  56).
5. Press and release the start/stop button once to begin recording.
  - For still image recording to a cassette, see p. 51.
  - The tally lamp flashes rapidly and REC appears in the display.
6. Press and release the start/stop button again to pause recording.
  - The camcorder returns to record pause mode and PAUSE reappears in the display.
  - You can stop and restart recording as often as you like by pressing the start/stop button.

**Note:**

- After loading a cassette, start recording when the tape counter has stopped.

### When you have finished recording

- Replace the lens cap.
- Return the viewfinder to its retracted position.
- Return the LCD screen flush to the camcorder body.
- Unload the cassette.
- Turn the POWER switch to OFF.
- Disconnect the power source.

**Notes:**

- To check that the camcorder is recording correctly, make a test recording first.
- Before making important recordings, clean the video heads using a Canon DVM-CL Digital Video Head Cleaning Cassette or a commercially available digital video head cleaning cassette.
- To close the LCD panel, rotate it vertically until the screen faces you, then push it in flat against the side of the camcorder until it clicks securely.
- You cannot monitor the sound from the speaker when recording.
- For tips on how to make better videos, see p. 34.
- For extra recording time, set REC MODE to any mode other than SP (  19).
- Do not hold the camcorder by the LCD panel, viewfinder, battery pack or built-in flash.



## Changing the recording mode

**E**

Choose from 4 recording modes: SP (standard play), 1.5× SP, 2× SP or 3× SP.

- Only SP and LP modes are available when the camcorder is set to CARD PLAY (MVX1i: CARD PLAY(VCR)) mode.

### Recording times (this example uses an 80-minute tape)

Standard recording	Extended recording		
SP	LP	SP	LP
80 min.	1.5× SP (120 min.)	2× SP (160 min.)	3× SP (240 min.)

In SP and LP modes, images data is compressed twice as much as in SP and LP modes when being recorded to a tape.

You can't add sound (audio dubbing) or images (AV insert: MVX1i only) to a tape that has been recorded in a mode other than SP mode. If you plan to use either of these functions later, record in SP mode.













To change the recording mode, open the menu and select VCR SET UP. Then select REC MODE, set it to LP, SP or LP and close the menu.

### Notes:

#### About all 3 extended recording modes

- When recording and playing back tapes in one of the extended recording modes, the nature of the tape and usage conditions may affect recording, mosaic-like noise may appear in the image and the sound may be distorted during playback. For important recordings, therefore, set the camcorder to SP mode.
- We recommend recording in SP mode when you plan to transfer images taken with the camcorder to your PC.
- If you record in more than one mode on the same tape, the picture may become distorted during playback and the time code may not be written correctly.
- A tape recorded in LP mode on other digital equipment may produce the mosaic-like noise and the sound may become distorted when playing back on this camcorder.
- A tape recorded in LP or LP mode on this camcorder may produce the mosaic-like noise and the sound may become distorted when playing back on other digital equipment.

**About  SP and  LP modes**

- The image quality of recordings done in  SP or  LP modes will be lower than that of those done in SP or LP modes.
- A cassette recorded in  SP or  LP mode cannot be played back on a camcorder not equipped with that mode.
- You might not be able to do DV dubbing correctly with the camcorder set to  SP or  LP mode.
- The recording mode might not appear in the display correctly if you switch to  SP or  LP while the camcorder is connected to another digital video device.
- When the recording mode is changed to  SP or  LP, the camcorder modifies the image for appropriate recording in that mode.

**16:9 (Wide screen TV recording)**

Produces images in the 16:9 format for playback on wide screen TVs.

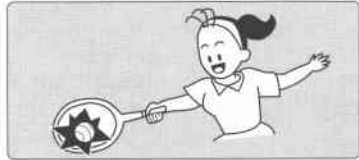

**TAPE** + **CAMERA**

**MENU**

(  37 )

▶CAM.SET UP



▶16:9.....OFF

**To switch 16:9 to ON, open the menu and select CAM.SET UP. Then select 16:9, set it to ON and close the menu.**

**Notes:**

- “16:9” is shown in the display when you switch the 16:9 mode on.
- You cannot use the 16:9 mode with the Easy Recording program.
- You cannot use the multi-image screen when setting the 16:9 mode on.
- If you play back a recording made for 16:9 on a normal TV screen, the image will appear to be vertically “squashed” (compressed).

## Turning off the tally lamp



The tally lamp lets you know that the camcorder is recording, receiving signals from the wireless controller or counting down for the self-timer. However, its flashing may be reflected into the lens during close-up recording, or when recording through glass.

You may therefore decide to turn it off.

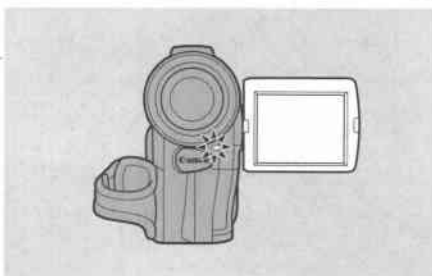

**TAPE** + **CAMERA** , **TAPE** + (**PLAY** / **PLAY(VCR)**) , **CARD** + (**PLAY** / **PLAY(VCR)**)

**MENU**  
( [ ] 37 )

▶ SYSTEM

▶ TALLY LAMP...ON

To turn the tally lamp off, open the menu and select **SYSTEM**. Then select **TALLY LAMP**, set it to **OFF** and close the menu.

- The tally lamp no longer flashes during recording, but it will still light up when the camcorder receives a signal from the wireless controller and during the self-timer countdown.

## Confirmation/Warning beeps



The camcorder's short operation confirmation beeps are indicated by  in the illustrations. Beeps sound upon certain camcorder operations such as when you turn the camcorder on, during the self-timer countdown, right before the camcorder's automatic shut-off, and also upon any unusual condition of the camcorder. Beeps are not recorded on the tape.

**TAPE** + **CAMERA** , **TAPE** + (**PLAY** / **PLAY(VCR)**) , **CARD** + **CAMERA** , **CARD** + (**PLAY** / **PLAY(VCR)**)

**MENU**  
( [ ] 37 )

▶ SYSTEM

▶ BEEP.....ON

To turn the beep off, open the menu and select **SYSTEM**. Then select **BEEP**, set it to **OFF** and close the menu.

# Zooming



E

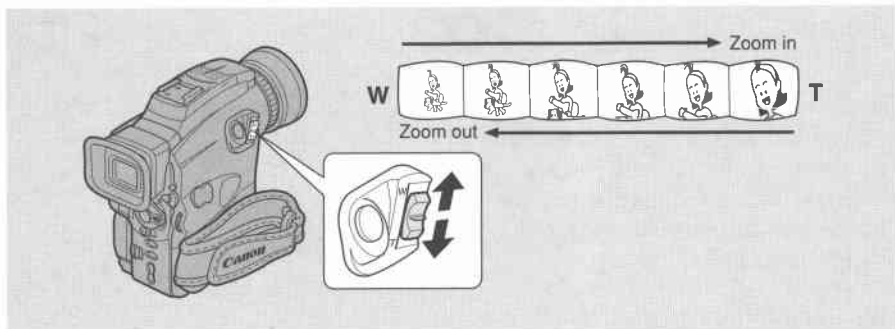

## 10× optical zoom

Card 8×

The camcorder's 10× zoom lens allows you to choose the best picture angle for each scene (up to 8× when using a memory card):

- Move the zoom control towards W to zoom out to wide-angle.
- Move it towards T to zoom in to telephoto.

You can also control the speed of zooming:

- Move the control slightly to zoom slowly.
- Move it farther to zoom more quickly. (The farther you move the zoom control, the faster the zoom speed.)

The T and W buttons on the wireless controller adjust the picture angle, but not the zoom speed.

## 200× digital zoom

Magnifies the camcorder's zoom range by up to 20× in TAPE CAMERA mode. The zoom control continues to work as usual. You can freely zoom in and out between 1× and 200× magnification — the camcorder automatically switches between optical zooming (up to 10×) and digital zooming (10× to 40× or 10× to 200×).

TAPE + CAMERA

**MENU**

( 37 )

▶CAM.SET UP

▶D.ZOOM.....40×

**To change the digital zoom, open the menu and select CAM.SET UP. Then select D.ZOOM, set it to OFF or 200× and close the menu.**

 **Notes:**

- When zooming, as a rule, keep at least 1 m (3 ft  $3\frac{3}{8}$  in) between you and your subject. However when the zoom is at the wide-angle position, you can focus on a subject as close as 1 cm ( $\frac{3}{8}$  in).
- Image resolution is slightly lower when the magnification is greater than 10 $\times$ .
- You cannot use digital zoom when the multi-image screen or mosaic is set. The display becomes “---”.
- The zoom indicator appears for 4 seconds. When the digital zoom is set to 40 $\times$ , the zoom indicator extends (light blue). When the digital zoom is set to 200 $\times$  zoom, the zoom indicator extends again (a darker blue).

## Using the LCD Screen

E

### Opening and closing the LCD screen

Push the LCD panel OPEN button and open the panel by pulling it away from the camcorder. This automatically switches the LCD screen on and the viewfinder off. When you close the LCD panel, the LCD screen automatically switches off and the viewfinder switches back on.

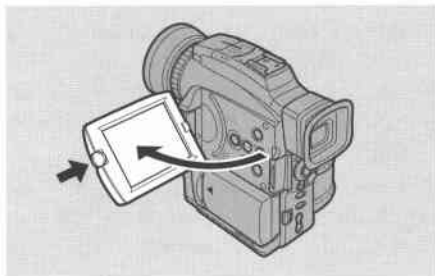

### Changing the angle of the LCD screen

You can choose the angle of the screen that suits you best by opening and rotating the screen, also you can rotate the LCD screen so that faces in the direction of the lens ( 26).

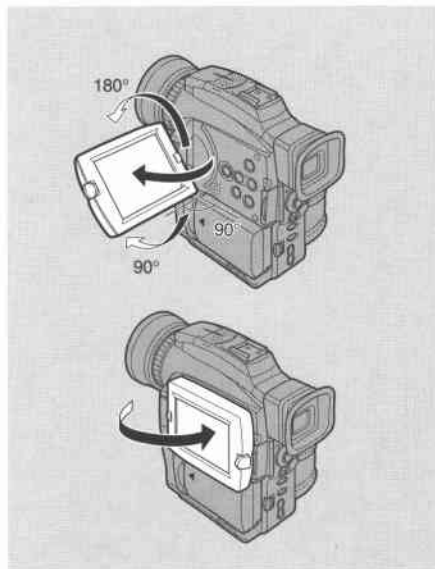

You can also push the panel flat against the camcorder until it is flush with the side, with the screen facing outwards.

#### Notes:

- Avoid touching the LCD screen when moving the LCD panel.
- Do not hold the camcorder by the LCD panel or the viewfinder.
- Make sure you open the LCD panel at 90°, before attempting to rotate it.
- Always rotate the LCD panel vertically into place, before closing it or pushing it flat against the side of the camcorder.
- Always fully close the LCD panel until it clicks securely.
- Be careful not to leave the LCD, viewfinder or lens exposed to direct sunlight outdoors or in a window. Doing so could cause damage.

- Bright light falling on the LCD screen may cause glare that makes it difficult for you to view the image. In this case, switch to using the viewfinder. You are also able to adjust the brightness of the screen (see “Adjusting the LCD screen” below).

## Adjusting the LCD screen



You can adjust the brightness of the LCD screen.



Open the menu and select **DISP.SET UP** from the menu. Then select **BRIGHTNESS**, adjust the level with the selector dial and close the menu.

A bar showing the level appears in the display.

- Turn the selector dial up to make the display brighter.
- Turn the selector dial down to make the display darker.

### Notes:

- The camcorder will remember your brightness setting even after you turn it off.
- The brightness of the LCD does not affect that of the recorded images or the viewfinder.

### About the LCD Screen

The LCD screen built into this camcorder is a high precision product.

However, small black dots or bright points of light (red, blue or green) may appear constantly on the LCD screen. This is not a malfunction of the LCD screen and they are not recorded on the tape. (Effective dots: more than 99.99%)

## Allowing the subject to monitor recording



When you turn the LCD panel so that it faces the same direction as the lens, you can watch yourself during recording or let your subject monitor recording. The viewfinder is also activated when the panel is in this position. (Adjust the viewfinder, 131)

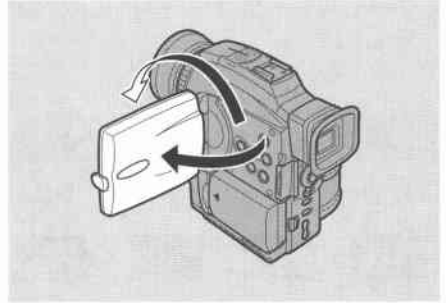

- You can choose the display style, reversed (mirror on) or not (mirror off). The recording itself is unaffected regardless of which one you choose.

**TAPE + CAMERA**, **CARD + CAMERA**

**MENU**  
( 37)



To turn the mirror mode off, open the menu and select **DISP.SET UP**. Then select **MIRROR**, set it to **OFF** and close the menu.

The indicators that appear in the LCD display when **MIRROR** is turned on:

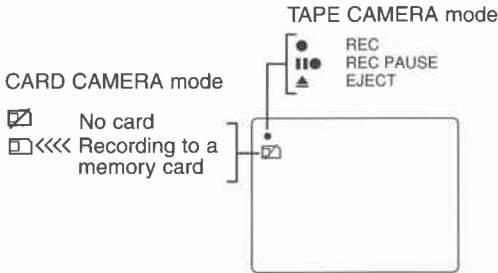

- These and all other indicators appear normally in the viewfinder.



## Playing Back a Cassette

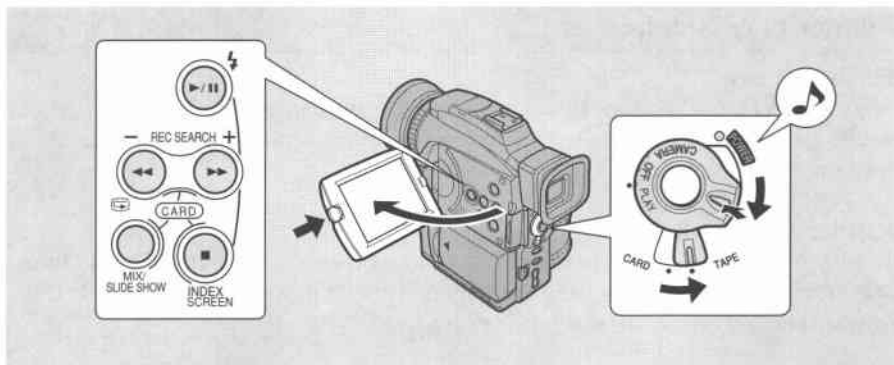

You can use the LCD screen for instant, on-the-spot playback. When using the LCD screen, the camcorder also plays back the sound track via the built-in speaker (  30).

- When you play back a tape, you can also close the LCD panel with its screen side facing up.
- When you're using the viewfinder to view playback, close the LCD panel. However, you cannot review the sound track.

To play back your recordings on a TV, see p. 31.

To use the wireless controller, see p. 45.

### Note:

- To avoid accidental recording, make sure that you slide the tab on the cassette so that it exposes the hole (the switch position is usually labelled SAVE or ERASE OFF).



### 1. Attach a power source and turn the POWER switch to PLAY (MVX1i: PLAY (VCR)).

- The power indicator lights up green.

### 2. Make sure the TAPE/CARD switch is set to TAPE.

### 3. Load the cassette.

### 4. Press the (play) button to start playback.

- To end playback, press the  (stop) button.
- To wind the tape forwards, stop playback and press the  (fast forward) button.
- To wind the tape backwards, stop playback and press the  (rewind) button.
- If the playback picture is rough (mosaic-like noise), clean the video heads using a Canon DVM-CL Digital Video Head Cleaning Cassette or a commercially available digital video head cleaning cassette.

## Other playback modes



### Playback pause

Press the **||** (pause) button. To resume normal playback, press it again, or press the **▶** (play) button. The camcorder automatically goes into stop mode after about 5 minutes' playback pause.

### Fast forward playback

To play back the recording at about 11.5 times normal speed, press and hold the **▶▶** (fast forward) button during normal playback or press and hold the **▶▶** (fast forward) button during normal fast forward.

### Rewind playback

For reverse playback at about 11.5 times normal speed, press and hold the **◀◀** (rewind) button during normal playback or press and hold the **◀◀** (rewind) button during normal rewind.

## Special playback



### Frame Advance

To play back frame by frame, press the **+ / ||▶** button repeatedly during playback pause.

Press and hold to play back continuous frame advance.

### Frame Reverse

To play back in reverse frame by frame, press the **- / ◀||** button repeatedly during playback pause.

Press and hold to play back continuous frame reverse.

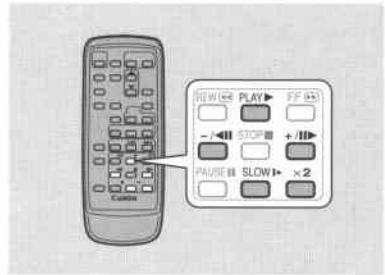

### Slow Forward Playback

To play back at about 1/5 normal speed, press the **SLOW ▶** button during normal playback.

Press the **PLAY ▶** button to return to normal playback.

- The camcorder automatically returns to playback after about 30 seconds of slow playback in **SP** or **LP** recording mode.

### Slow Reverse Playback

To play back in reverse at about 1/5 normal speed, press the **- / ◀||** button and then the **SLOW ▶** button during normal playback.

Press the **PLAY ▶** button to return to normal playback.

- The camcorder automatically returns to  $\times 1$  reverse playback after about 30 seconds of slow playback in **SP** or **LP** recording mode.

### Reverse Playback

To play back in reverse at normal speed, press the **-/◀|||** button during normal forward playback.

Press the **PLAY ▶** button to return to normal forward playback.

- The camcorder automatically goes into stop mode after about 2 minutes of paused reverse playback.

### Forward ×2 Playback

Press the **×2** button during normal playback.

Press the **PLAY ▶** button to return to normal playback.

### Reverse ×2 Playback

Press the **-/◀|||** button and then the **×2** button during normal playback.

Press the **PLAY ▶** button to return to normal playback.



#### Notes:

- Mosaic-like noise appears on the screen during some of the special playback modes.
- There's no audio during special playback.

## Built-in speaker



The camcorder has a built-in speaker so you can review the sound track alongside the picture when you're using the LCD screen to play back a tape. The built-in speaker is monaural.

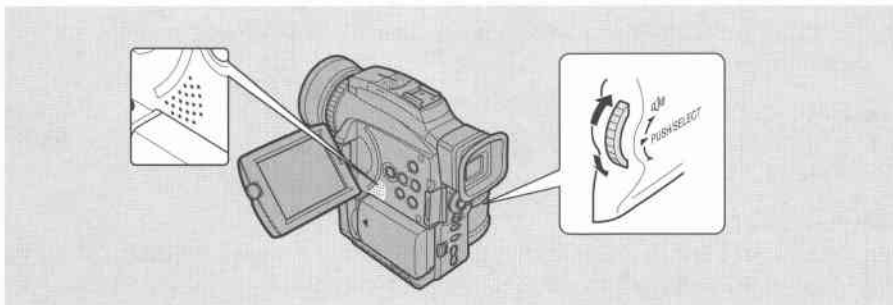

Adjust the speaker volume by turning the selector dial.

- Turn the selector dial up to increase the volume, and down to lower the volume.
- A bar appears in the display to indicate the current volume. It disappears in 4 seconds.
- You can turn off the volume completely by turning the selector dial down until OFF appears. You can monitor the sound again by turning the selector dial up.
- You can adjust the headphone volume separately from the built-in speaker, either during TAPE PLAY (MVX1i: TAPE PLAY (VCR)) mode or TAPE CAMERA mode. The volume level is the same regardless of mode.
- The levels you adjust for the built-in speaker and headphones are memorized separately. The camcorder remembers your levels even if you turn the camcorder off and back on again.



### Notes:

- Sometimes audio may sound distorted when the volume is turned up high. If this happens, turn down the volume.
- The speaker turns off when the camcorder is set to any mode other than TAPE PLAY (MVX1i: TAPE PLAY (VCR)) mode or when you use headphones.

## Connections for Playback on a TV Screen

You can connect the camcorder to a TV or VCR in order to play back your recordings. You will need to attach a power source to the camcorder (  10). Power off all devices before starting the connections.

See your TV or VCR instruction manual for further details.

### If your TV (or VCR) has a SCART terminal (without S (S1)-video)

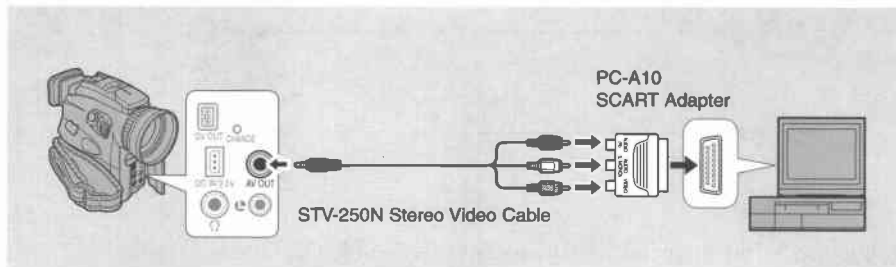

- Connect the PC-A10 SCART adapter to the TV or VCR's SCART terminal.
- Connect the camcorder to the adapter. Connect the camcorder using the STV-250N Stereo Video Cable. Connect the white plug to the white audio terminal **L** (left). Connect the red plug to the red audio terminal **R** (right). Connect the yellow plug to the yellow video terminal **VIDEO**.
- If you are connecting the camcorder to a TV, set the TV/VIDEO selector on the television to **VIDEO**.
- If you are connecting the camcorder to a VCR, set the input selector on the VCR to **LINE**.

**If your TV (or VCR) has an S (S1) -video input terminal**

For higher picture quality, we recommend playing back recordings on a TV with an S (S1) terminal.

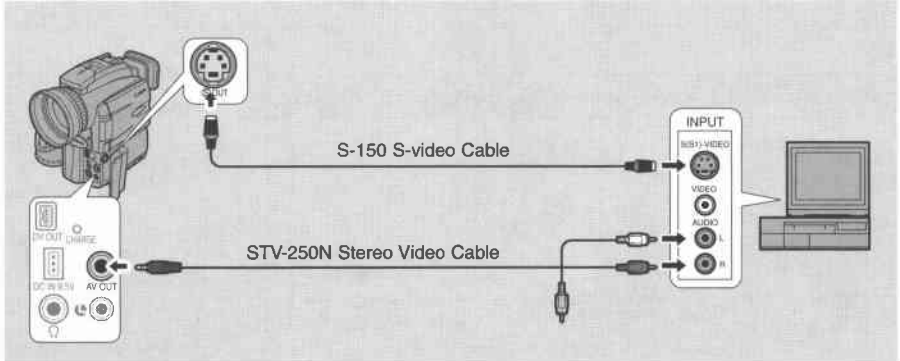

- Use the S-150 S-video Cable to connect the S-video terminals. Use the STV-250N Stereo Video Cable to connect the AUDIO terminals. Connect the white plug to the white AUDIO terminal **L** (left). Connect the red plug to the red AUDIO terminal **R** (right). Do not connect the yellow plug.
- If you are connecting the camcorder to a TV, set the TV/VIDEO selector on the television to VIDEO.
- If you are connecting the camcorder to a VCR, set the input selector on the VCR to LINE.

## If your TV (or VCR) has audio/video input terminals

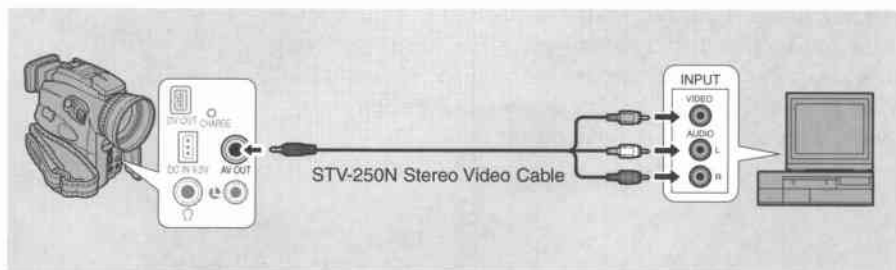
**E**

- Connect the camcorder using the STV-250N Stereo Video Cable. Connect the white plug to the white audio terminal **L** (left). Connect the red plug to the red audio terminal **R** (right). Connect the yellow plug to the yellow video terminal **VIDEO**.
- If you are connecting the camcorder to a TV, set the TV/VIDEO selector on the television to **VIDEO**.
- If you are connecting the camcorder to a VCR, set the input selector on the VCR to **LINE**.



### **Note:**

- If you are going to use the TV as a monitor while you are shooting, remember to keep the TV volume turned down as long as the camcorder's audio terminals are connected. If the sound from the TV speakers is picked up by the microphone, an unpleasant high-pitched squeal, called feedback, may be produced.

## Tips for Making Better Videos

E

### Holding the camcorder

For maximum stability, grip the camcorder in your right hand and keep your right elbow pressed against your body. If necessary support the camcorder with your left hand. With practice, you will be able to operate the controls by touch, without taking your eye off the action.

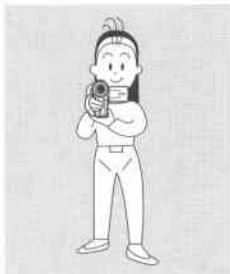

### Using a tripod

To prevent any unwanted movement, you can mount the camcorder on a tripod, (or any flat surface at a suitable height) and operate it with the wireless controller.

- When you are using a tripod, be careful not to leave the viewfinder exposed to bright sunlight or it may melt. (The light is concentrated by the viewfinder lens.)
- Make sure that the fastening screw of the tripod is no longer than 5.5 mm (1/4 inch), or it will damage the camcorder.



### Composition

The most important element in the scene does not have to be in the centre. For a more interesting picture, try to position your subject so it is slightly to one side. Leave some space on the side of the frame that the subject is facing or moving towards.

Don't cut off the top of the subject's head, and don't cut people off at the neck, hips or knees (move a little bit above or below).

Watch out for distracting objects in the background.





## Picture angle

Instead of zooming while recording, try to choose your picture angle before you begin. A good way to tell a story with video is to begin with a long shot that establishes the situation, and then move in with medium shots and close-ups to show the details. Remember to change your viewpoint for each shot.

Remember that any camcorder movement or change in picture angle should have a definite purpose. Avoid unnecessary or half-hearted movements.



Long shot



Medium shot



Close-up

## Camcorder moves

Use pans to record a landscape or follow a moving subject. Decide the area you want to cover and stand facing the end of your panning angle. Without moving your feet, turn your waist to the starting position. Start recording, and after a few seconds begin to turn slowly from the waist. Hold the final image for a few seconds before you stop recording.

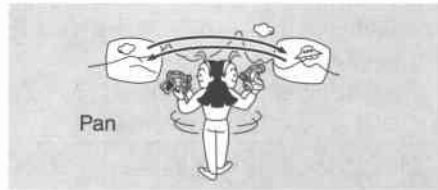

Pan

Tilt the camcorder up to exaggerate the height of the subject. Tilt down from the top of a building, for example, as an introduction to subjects at the bottom.



Tilt

## Searching and Reviewing While Recording

E

### Record search



When the camcorder is in record pause mode, you can use record search to play the tape forwards or backwards to find the point where you want to start or resume recording. This is useful when you want to add a new scene to a previously used cassette. By using record search, you can ensure a smooth, noise-free join between the new scene and the old one.

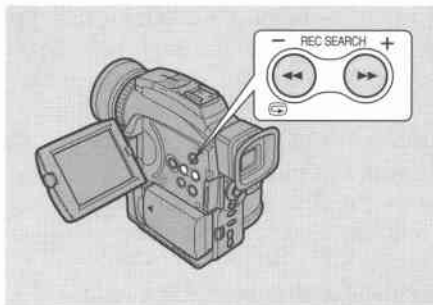

**TAPE** + **CAMERA**

1. **Press and hold the REC SEARCH + or – button on the camcorder while you check the picture in the display.**
  - The + button plays the recording forwards and the – button plays it backwards.
2. **Release the button when you find the point where you want to start recording.**
  - The camcorder returns to record pause mode.

### Record review



When the camcorder is in record pause mode, you can use record review to play back the last few seconds of your recording and then return automatically to record pause mode. You can quickly make sure that a scene has recorded properly and then go on to shoot the next scene, without producing any noise in the picture.

**TAPE** + **CAMERA**

1. **Press and release the  (record review) button while you check the picture in the display.**
  - The camcorder rewinds the tape, plays back the last few seconds, and returns to record pause mode.



#### Note:

- Noise may appear on the screen when you play the tape backwards.

# Using the Menu



E

Many of the camcorder's advanced functions are selected from menus which appear in the display.

There are 4 main menus:

- CAM. MENU      Camera menu      ( 39)
- PLAY MENU (MVX1i :VCR MENU)      ( 40)
- C. CAM. MENU      Card camera menu      ( 42)
- C.PLAY MENU      Card play menu      ( 43)

## ● CAM. MENU      TAPE + CAMERA

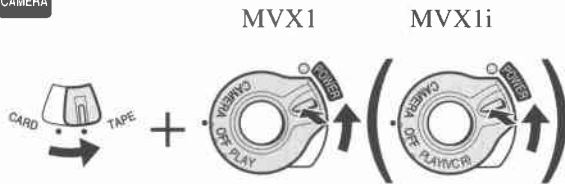
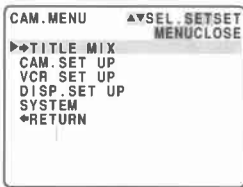

## ● PLAY MENU (MVX1i: VCR MENU)      TAPE + (PLAY PLAYVCR)

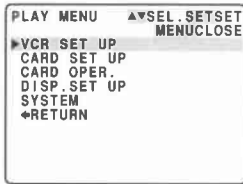

## ● C.CAM. MENU      CARD + CAMERA

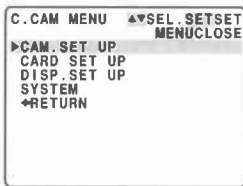

## ● C.PLAY MENU      CARD + (PLAY PLAYVCR)

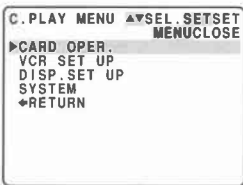

Using the Full Range of Features

## Selecting from the Menu

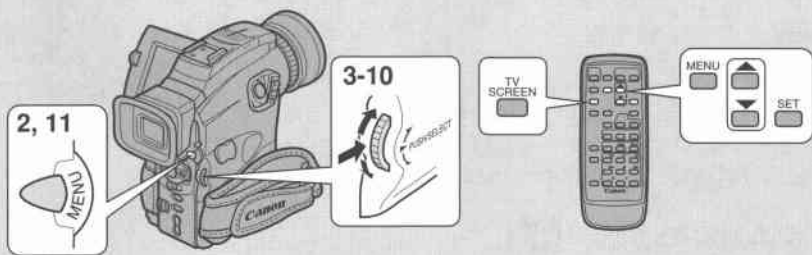

1. Turn the **POWER** switch and the **TAPE/CARD** switch to the desired settings.
2. Press the **MENU** button to open the menu.
  - One of the main menus appears, according to the settings of the **TAPE/CARD** switch and the **POWER** switch.
3. Turn the selector dial and move the arrow to the desired submenu.
4. Press the selector dial in to select.
  - The submenu appears.
5. Turn the selector dial and move the arrow to the desired function.
6. Press the selector dial in to select.
  - The function and its settings only appear.
7. Turn the selector dial and move the arrow to the desired setting.
  - If you are setting a function other than the white balance or shutter speed, the function will be set if you skip to step 11.
8. Press the selector dial in to select.
  - The function is set and you return to the submenu.
9. Turn the selector dial and move the arrow to **RETURN**.
10. Press the selector dial in to select.
  - You return to the main menu.
11. Press the **MENU** button.
  - The main menu disappears.



### Notes:

- Pressing the **MENU** button at any time closes the menu.
- Selecting **RETURN** takes you back one menu, or closes the main menu.
- Items that are unavailable, due to the tape or card situation or the settings of other menu items, appear in purple.
- You may often find it convenient to use the wireless controller to move around the menus. Press its **MENU** button to open/close the menu and use the arrow keys in place of turning the selector dial. Push the **SET** button to select.

- Pressing the start/stop button or the PHOTO button will close the menu and start recording.
- You can display the menus on a connected TV screen by turning TV SCREEN ( 148) on through the menu or using the wireless controller's TV SCREEN button. See p. 31 for TV hookup instructions.

**List of Menus**  

Turn to appropriate page for a detailed explanation of each function.

**● CAM. MENU**

Set the POWER switch to **CAMERA** and the TAPE/CARD switch to **TAPE**. There are 5 submenus within the CAM. MENU.

- 1 To title mix submenu
- 2 To camera set up submenu
- 3 To VCR set up submenu
- 4 To display set up submenu
- 5 To system menu
- 6 Close main menu

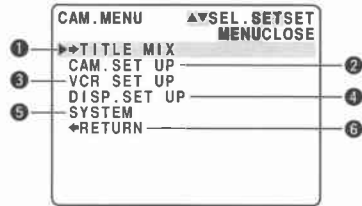

**1 Title mix submenu**

- 1 Mix type..... 123
- 2 Mix level..... 123

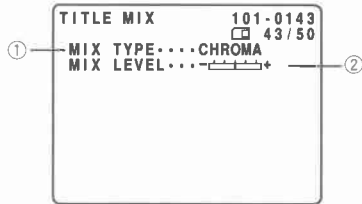

**2 Camera set up submenu**

- 3 Shutter speed..... 75
- 4 Digital zoom ..... 22
- 5 Image stabilizer..... 55
- 6 16:9 effect ..... 20
- 7 White balance ..... 78
- 8 Return

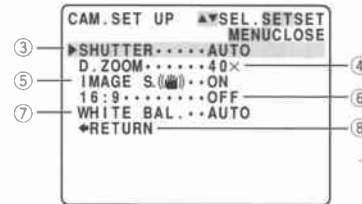

## CAM. MENU, cont.

## 3 VCR set up submenu

- 9 Record mode..... 19
- 10 Wind screen ..... 68
- 11 Audio mode ..... 67
- 12 Return

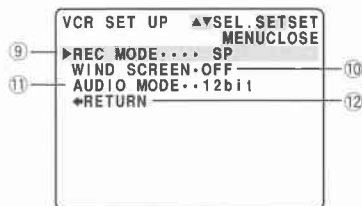

## 4 Display set up submenu

- 13 Brightness ..... 25
- 14 Mirror mode..... 26
- 15 TV screen..... 148
- 16 Date/time display ..... 50
- 17 Return



## 5 System submenu

- 18 Wireless controller..... 46
- 19 Tally lamp..... 21
- 20 Beep ..... 21
- 21 Time zone/  
Daylight saving time..... 48
- 22 Date/time set..... 50
- 23 Return

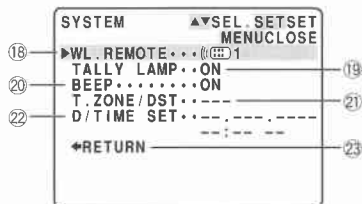

## ● PLAY MENU (MVX1i: VCR MENU)

Set the POWER switch to ( **PLAY** / **PLAY/VCR** ) and the TAPE/CARD switch to **TAPE** .  
There are 5 submenus.

- 1 To VCR set up submenu
- 2 To card set up submenu
- 3 To card operations submenu
- 4 To display set up submenu
- 5 To system submenu
- 6 Close main menu

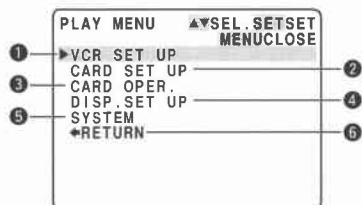

**1 VCR set up submenu**

- ① Record mode \* ..... 19
  - ② Output channel ..... 101
  - ③ Audio dubbing\* ..... 98
  - ④ Wind screen ..... 68
  - ⑤ Audio mode\* ..... 67
  - ⑥ Return
- \* MVX1i only

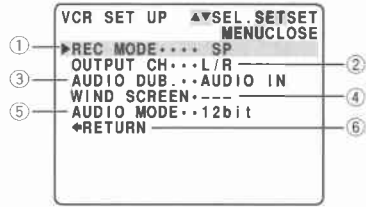
**2 Card set up submenu**

- ⑦ Image quality ..... 104
- ⑧ File numbers ..... 106
- ⑨ Return

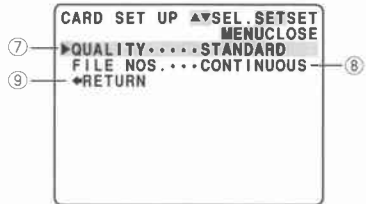
**3 Card operations submenu**

- ⑩ Copy from cassette to card. .... 125
- ⑪ Return

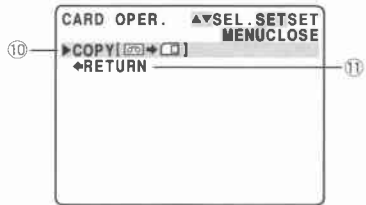
**4 Display set up submenu**

- ⑫ Brightness ..... 25
- ⑬ Displays ..... 148
- ⑭ 6-second auto date ..... 82
- ⑮ Data code ..... 81
- ⑯ Date/time select ..... 80
- ⑰ Return



## PLAY MENU (MVX1i: VCR MENU), cont.

## 5 System submenu

- 18 Wireless controller..... 46
- 19 Tally lamp..... 21
- 20 Beep..... 21
- 21 Return

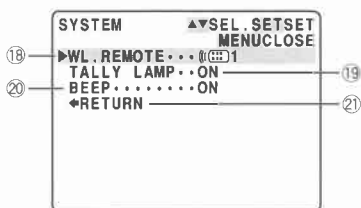

## C. CAM. MENU

Set the POWER switch to **CAMERA** and the TAPE/CARD switch to **CARD**. There are 4 submenus within the C. CAM. MENU.

- 1 To camera set up submenu
- 2 To card set up submenu
- 3 To display set up submenu
- 4 To system submenu
- 5 Close main menu

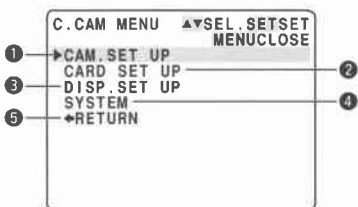

## 1 Camera set up submenu

- 1 Shutter speed..... 75
- 2 Image stabilizer..... 55
- 3 White balance..... 78
- 4 Return

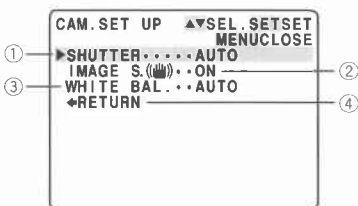

## 2 Card set up submenu

- 5 Image quality..... 104
- 6 Image resolution..... 105
- 7 File numbers..... 106
- 8 Shutter sound..... 106
- 9 Return

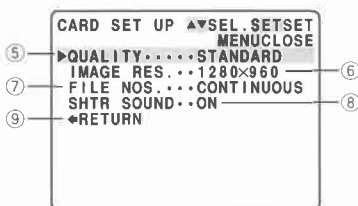



### 3 Display set up submenu

- ⑩ Brightness ..... 25
- ⑪ Mirror mode..... 26
- ⑫ TV screen..... 148
- ⑬ Date/time display ..... 50
- ⑭ Return

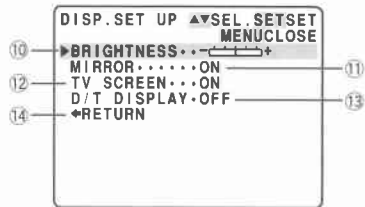

### 4 System submenu

- ⑮ Wireless controller..... 46
- ⑯ Beep..... 21
- ⑰ Time zone/  
Daylight saving time..... 48
- ⑱ Date/time set..... 50
- ⑲ Return

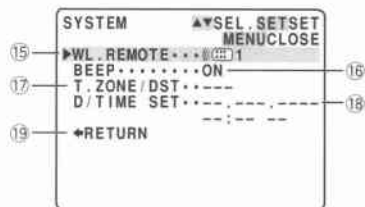

## ● C. PLAY MENU

Set the POWER switch to ( **PLAY** / **PLAY VCR** ) and the TAPE/CARD switch to **CARD** .  
There are 4 submenus within the C. PLAY MENU.

- ① To card operations submenu
- ② To VCR set up submenu
- ③ To display set up submenu
- ④ To system submenu
- ⑤ Close main menu

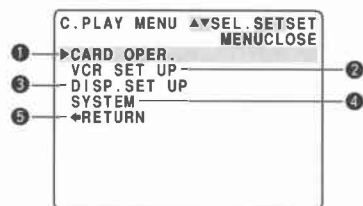

### ①-1 Card operations submenu (when playing back a single image)

- ① Copy from card to cassette ... 126
- ② Erase all print marks..... 118
- ③ Image erase ..... 119
- ④ Format..... 127
- ⑤ Return

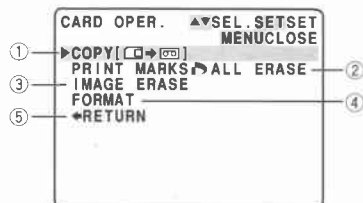

## C. PLAY MENU, cont.

### ②-2 Card operations submenu (when displaying an index screen)

- ⑥ To image protect ..... 116
- ⑦ To print mark ..... 117
- ⑧ Return



### ③ VCR set up submenu

- ⑨ Record mode ..... 19
- ⑩ Return

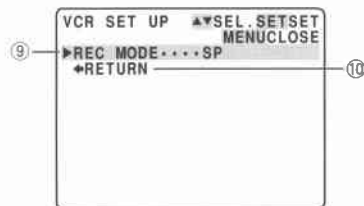

### ③ Display set up submenu

- ⑪ Brightness ..... 25
- ⑫ Displays ..... 148
- ⑬ Date/time select ..... 80
- ⑭ Return

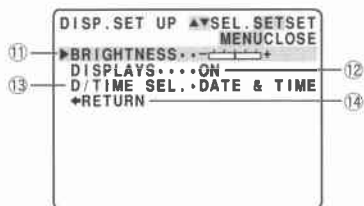

### ④ System submenu

- ⑮ Wireless controller ..... 46
- ⑯ Tally lamp ..... 21
- ⑰ Beep ..... 21
- ⑱ Return

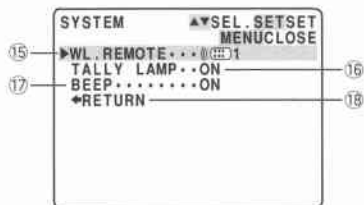

## Using the Wireless Controller

The supplied wireless controller can operate the camcorder from a distance of up to 5 m (16 feet). Point it at the camcorder's remote sensor while you press the buttons.

There are some functions that cannot be operated without the wireless controller:

- Special playback (□ 28)
- Photo/date search (□ 83)
- Zero set memory (□ 84)
- Audio mix (□ 100)
- AV insert (□ 92: MVX1i only)
- Audio dubbing (□ 95)

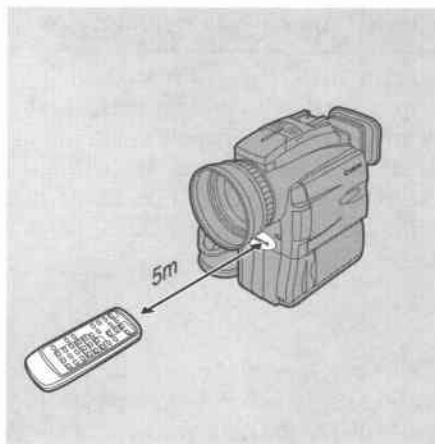

E

## Inserting batteries

Insert two AA batteries, following the ⊕ and ⊖ markings. Be careful not to reverse the polarity of the batteries.

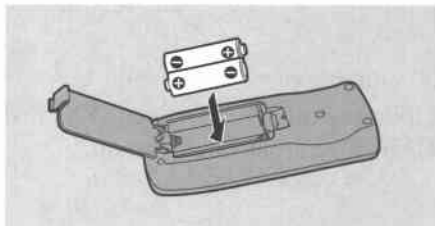

### Notes:

- When using the wireless controller in brightly lit places or outdoors, the effective range will be less.
- The camcorder may have difficulty picking up the remote control signals at extremely close range.
- Do not leave the controller exposed to direct sunlight, or in hot or humid places.
- When the batteries run out, replace them both together.
- If the wireless controller doesn't work, see p. 47.

## When Operating 2 Canon DV Camcorders (Remote Sensor Mode)



To prevent interference from other Canon wireless controllers being used nearby, there are 2 remote sensor modes and an off setting. The wireless controller and the camcorder have to be set to the same mode in order to be compatible.

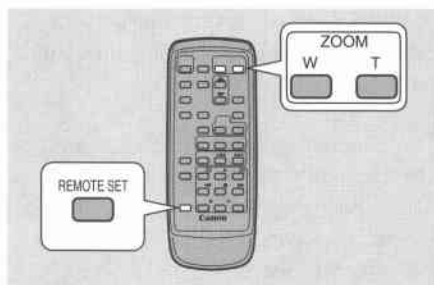

The wireless controller and the camcorder have been preset to mode 1. If you change the mode on the camcorder, be sure to change the mode on the wireless controller to the same mode.

TAPE + CAMERA, TAPE + (PLAY/PLAY(VCR)), CARD + CAMERA, CARD + (PLAY/PLAY(VCR))

**MENU**  
( 37 )



Ⓜ 1 : Mode 1  
 Ⓜ 2 : Mode 2  
 OFF Ⓜ : Sensor off

To turn the remote sensor off:

**Open the menu and select SYSTEM. Then select WL.REMOTE, set it to OFF Ⓜ and close the menu.**

- Ⓜ appears in the display.

To change the mode...  
 ...on the camcorder:

**Open the menu and select SYSTEM. Then select WL.REMOTE, set it to Ⓜ 1 or Ⓜ 2 and close the menu.**

- The selected mode will appear on the display for 4 seconds.

...on the wireless controller:

**Press and hold the REMOTE SET button on the wireless controller.**

**Simultaneously press the ZOOM W button for mode 1 or the ZOOM T button for mode 2. Continue to press simultaneously for over 2 seconds.**

- Be sure to set the wireless controller to the same mode as the camcorder.

**If your wireless controller isn't working:**

Make sure the camcorder and the wireless controller are both set to the same mode. Check the mode the camcorder is set to by pushing any button other than the REMOTE SET button on the wireless controller. The camcorder's mode appears in purple for about 4 seconds. Set the wireless controller's mode accordingly by pressing the aforementioned button combinations. If the wireless controller still doesn't work, change the batteries.

**Note:**

- The mode the camcorder is set to also appears for 4 seconds when you turn the power on.

## Setting the Date and Time

E

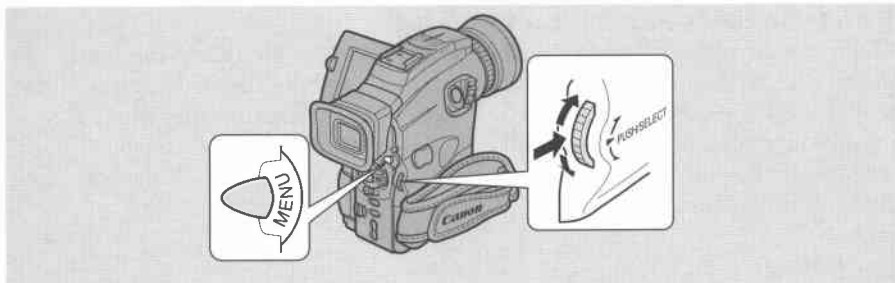

The date and/or time display forms part of the data code. You can choose to display or hide it during playback ( 80).

Set the date and time display when you first start using your camcorder. Install the backup battery before you begin ( 135).

- Before you start setting the date and time, select your home time zone from the menu.

### Setting the time zone/daylight saving time



TAPE + CAMERA , CARD + CAMERA

**MENU**  
( 37)

▶ SYSTEM

▶ T.ZONE / DST · · PARIS

1. Open the menu and select **SYSTEM**.
2. Select **T.ZONE/DST**.
  - The time zone display appears on the screen.
  - Your camcorder's time zone is factory-preset to Paris. If you are at another time zone, select your time zone first and daylight saving time (DST) setting if necessary.
3. Move up or down the list of time zones with the selector dial. Select the option that represents your time zone.
  - If you are now in daylight saving time, select the time zone with the daylight saving time mark next to the area.
4. Close the menu.

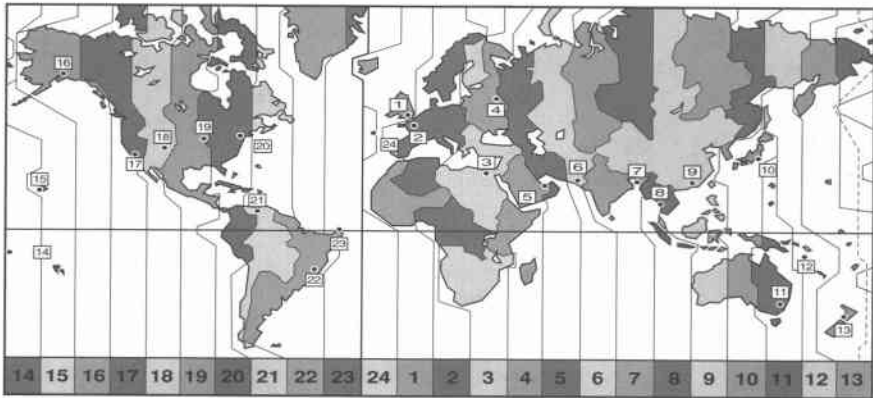

No.	Time zone	No.	Time zone
1	LONDON	13	WELLGTN (Wellington)
2	PARIS	14	SAMOA
3	CAIRO	15	HONOLU. (Honolulu)
4	MOSCOW	16	ANCHOR. (Anchorage)
5	DUBAI	17	L.A. (Los Angeles)
6	KARACHI	18	DENVER
7	DACCA	19	CHICAGO
8	BANGKOK	20	N.Y. (New York)
9	H. KONG (Hong Kong)	21	CARACAS
10	TOKYO	22	RIO (Rio de Janeiro)
11	SYDNEY	23	FERNAN. (Fernando de Noronha)
12	SOLOMON	24	AZORES

### Notes:

- After you have selected your time zone and set the date and time, when you travel to another time zone, there is no need to reset the date and time. Just set the time zone to your destination and the camcorder's clock will automatically change to display the correct time for your destination.
- The camcorder automatically accounts for the number of days in a month and leap year.

## Setting the clock



After you set the date and time, the date/time and home time zone will be displayed for about 4 seconds each time you turn the power on.

TAPE + CAMERA, CARD + CAMERA

**MENU**  
( 37 )

▶ SYSTEM

▶ D/TIME SET... 1, JAN, 2001  
12:00 AM

1. Open the menu and select **SYSTEM**.
2. Select **D/TIME SET**.
  - The year display starts to flash.
3. Turn the selector dial up and down to change the year. Press the dial in to move to another part of the display.
  - Once you move from the year, the next part of the display starts flashing.
4. Set the month, day, hours, and minutes in the same way.
5. Press the **MENU** button when finished, and to start the clock.

### Notes:

- To make a change to part of the date and time, press the selector dial in at step 3 to move to the part to be changed. Turn the dial to make the change, then close the menu.
- The date can be set to any year between 2001 and 2030.
- If you press the **MENU** button in the middle of setting the date and time, you leave the menu, and the clock starts.
- If you press the selector dial in after setting the minutes you can set the date and time again from the start.

## Date and time display



You can choose to display or hide the date and time display during recording. When the date and time display is set to **ON**, the date and time show in the lower left-hand corner of the display but the time zone disappears in about 4 seconds. The large, 4-second display will no longer appear when you turn on the power. It is not automatically superimposed on your recordings.

TAPE + CAMERA, CARD + CAMERA

**MENU**  
( 37 )

▶ DISP.SET UP

▶ D/T DISPLAY-OFF

To turn it on, open the menu and select **DISP.SET UP**. Then select **D/T DISPLAY**, set it to **ON** and close the menu.



## Taking Still Pictures to a Cassette



To take still images on a memory card, see p. 107.

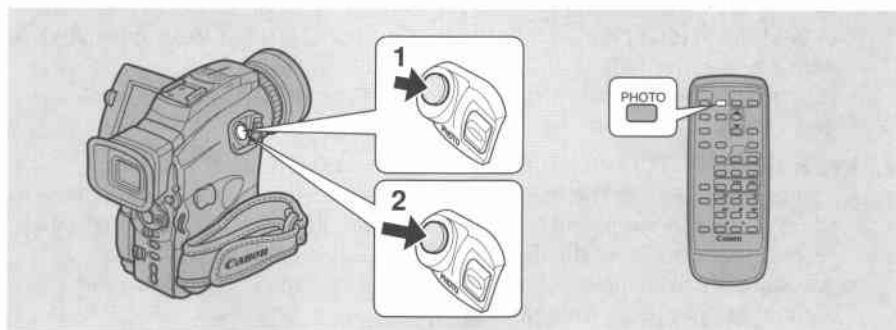

You can record still pictures like a photograph. The camcorder records the picture and sound to tape for several seconds. The exposure is automatically adjusted. Copy still photos automatically to a memory card (□ 125) for transfer to a PC for image enhancement and printout. Also, starting your shooting with a still photo makes it easy to find the beginning again later with the Photo Search function (□ 83).

You can take a still picture at any time during regular video recording, or you can put the camcorder into record pause mode first, then take a still picture. Also, you can use the built-in flash when taking still pictures from record pause mode (□ 53).

**TAPE + CAMERA**

### During record mode





**Press the PHOTO button fully down and the still picture will be taken immediately.**

- The camcorder takes the image immediately, and then records the “photo” to the tape for approximately 6 seconds (8 seconds in **SP** or **LP** recording mode). During this time the camcorder also records the sound, and the display shows the still picture.
- A counter display appears, and counts up as the camcorder records the picture.
- The camcorder returns to record pause mode.

### During record pause mode

**1. Press the PHOTO button halfway down and hold it:**

- “PHOTO” flashes at the bottom right of display.
- Exposure is locked.
- During autofocus **AF** flashes white in the display as the camcorder adjusts the focus and it is displayed continuously as a green mark when the camcorder is ready to take the still picture.

- If the subject is unsuitable for autofocus (  141), the camcorder may not be able to focus, and  may continue to flash white in the display. Continue to hold the PHOTO button halfway down, then adjust the focus manually with the selector dial.
- If you are using manual focus (  77), the  mark starts as a continuous green mark. Focus with the selector dial.

## 2. Press the PHOTO button fully down to take the still picture.

- The camcorder takes the image immediately, and then records the “photo” to the tape for approximately 6 seconds\*. During this time the camcorder also records the sound, and the display shows the still picture.
- A counter display appears, and counts up as the camcorder records the picture.  disappears from the display.
- The camcorder returns to record pause mode.



### Notes:

- The camcorder automatically returns to record pause mode after recording a still image for approximately 6 seconds\*. If you turn the POWER switch to OFF during that time, the camcorder will respond only after recording is complete.
- The wireless controller’s PHOTO button has no half-way setting. Press the button fully and the camcorder immediately takes the “photo”.
- Only take “photos” where it is bright enough to see the image in the display.

\* 8 seconds in  SP or  LP recording mode.

## Using the Built-in Flash

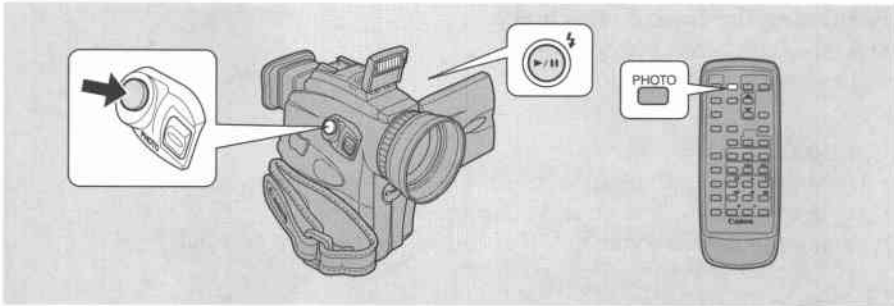
**E**

You can take natural-looking flash pictures with appropriate illumination using the built-in flash, whether they are night scenes, indoors or in other dark places. It also reduces red-eye effect when shooting people at night or in dark indoor places.

- ⚡<sup>A</sup> (Auto): The flash automatically fires according to the brightness of the subject.
- ⊙ (Red-eye reduction auto): The flash pre-fires automatically before the main firing to reduce red-eye effect.
- ⚡ (Flash on): The flash is forced to fire regardless of the brightness of the subject.
- ⊘ (Flash off): The flash does not fire. Use this setting when you are shooting in places where flash photography is prohibited.

Using the Full  
Range of Features

### Changing the setting of the flash

TAPE + CAMERA , CARD + CAMERA

#### 1. Press the ⚡ (flash) button.

- The display changes in the following order with each press of the button.  
⚡<sup>A</sup> (Auto) → ⊙ (Red-eye reduction auto)  
⊘ (Flash off) ← ⚡ (Flash on) ←
- The selected mode appears in the display, with the exception of ⚡<sup>A</sup> (Auto), which is displayed and then disappears after 4 seconds.
- When you press the flash button while Auto is selected and ⚡<sup>A</sup> is not displayed, ⚡<sup>A</sup> appears. Then, when you press the button while it is displayed, you can change the setting.

#### During record pause mode

#### 2. Press the PHOTO button half way down and hold it.

- The flash automatically rises.
- ⚡ appears green in the display.

#### 3. Press the PHOTO button fully down to take the still picture.

- The flash fires.
- During recording, the display shows the still image.

## Returning the flash to the body

Press the flash down with your hand.



- Do not return the flash to the body while it is firing.

### Caution:

- Do not fire the flash close to people's eyes.
- Do not fire the flash at drivers while they are driving.
- Do not fire the flash with the flash bulb covered with your hand.



### Notes:

- The practical range of flash picture is approximately from 1 m to 3 m. Depending on the recording conditions, the range varies.
- Your camcorder automatically adjusts the flash exposure according to the brightness of the subject (Flash exposure compensation). The flash fires to perform flash exposure compensation before the main firing for taking photos. When  (Red-eye reduction auto) is set, the flash fires to perform flash exposure compensation between the pre-firing for red-eye reduction and the main firing for taking photos. It takes about 1 second between the pre-firing for red-eye reduction and the main firing.
- In "Red-eye reduction auto" mode, the subject needs to look at the pre-firing flash in order to have red-eye reduction effective. The degree of reduction varies on the distance to the subject and also on each individual.
- If the flash is forced to fire (Flash on) in a bright location, the effect of flash photography sometimes may not be obtained.
- The flash does not fire in the following cases:
  - When exposure is locked in Auto or Red-eye reduction auto mode.
 Flash display changes to purple:
  - When the optional VL-3 Video Light attached to the camcorder is set to any setting other than OFF.
  - When a shutter speed of 1/2000 or faster is set in the TAPE CAMERA mode. However, in the case that "Flash on" is selected, the display of the selected shutter speed flashes (in purple) for four seconds, then changes to "1/1000" (yellow), and the flash fires.
 The flash display flashes in red:
  - When an abnormality occurs during charging (  140).
 The flash display disappears:
  - When multi-image screen is selected.
  - When you are recording movies onto a tape.
- The flash does not fire if  does not appear green in the display when you press the PHOTO button. Set it to "Flash on" mode when necessary.
- When the flash is fired with a lens hood or an optional tele-converter attached to the camcorder, its shadow may be recorded.
- When a tape recorded using a flash is played back on different equipment, the image may flicker.

## Turning the Image Stabilizer Off

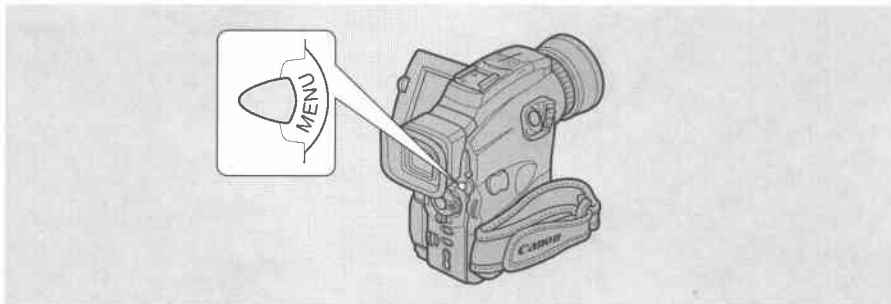
**E**

With most camcorders, even the slightest hand movements will be noticeable during telephoto recording. However, the MVX1/MVX1i's Optical Image Stabilizer allows you to obtain steady recordings even at high magnification. Unlike electronic image stabilizers, it causes no loss of picture quality. The Optical Image Stabilizer can compensate for a wide range of camera movement — you can record stable images even if you are shooting from a moving car.

TAPE + CAMERA , CARD + CAMERA

**MENU**

( 37 )

▶CAM. SET UP

▶IMAGE S. ( ) · · ON

**To turn the image stabilizer off, open the menu and select CAM.SET UP. Then select IMAGE S. ( ), set it to OFF and close the menu.**

- The ( ) mark disappears from the display when the stabilizer is off.
- The image stabilizer cannot be turned off when the program selector is set to the □ (Easy Recording) position.



### Notes:

- Keep the image stabilizer turned off when the camcorder is mounted on a tripod.
- The image stabilizer is designed to deal with a normal degree of camcorder shake.

## Using the Various Recording Programs

E

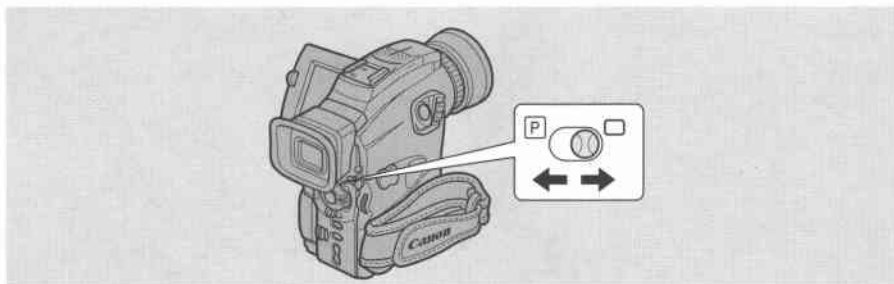

The camcorder provides you with a choice of 7 recording programs. They use different combinations of camcorder settings in order to adjust the exposure and other functions to match the recording situation.

- For simple point-and-shoot operation, select the Easy Recording program. Slide the program selector to the □ position.
- For normal shooting conditions, slide the program selector to P (program AE) mode. Open the program menu and select AUTO ( 57).
- For various other recording conditions, the camcorder has 5 more specialised AE (auto exposure) programs.

### Availability of functions in each recording program

Position of program selector							
Recording Program	□ (Easy Recording)	Auto	Sports	Portrait	Spotlight	Sand & Snow	Low Light
Shutter Speed	A	○			A		
Focus					○		
White balance					○		
Exposure					○		
Image stabilizer (ON/OFF)		ON				○	
Digital effects		×				○	
16:9	×				○		

○ : Available    × : Not available    A : Automatic function only

## Setting the program AE mode



TAPE + CAMERA

CARD + CAMERA

1. Slide the program selector to **P** (program AE) mode.
2. Press the selector dial in to display the program menu.
3. Turn the selector dial to move the arrow up or down the display.
4. Press the selector dial in to select the desired program.
  - The program will appear in the display.

### Notes:

- The name of your selected recording program appears constantly on the left of the display, with the exception of Auto, which is displayed and then disappears after 4 seconds.
- Avoid changing programs during recording as the brightness of the image may change suddenly.
- If you switch the camcorder from the **□** program to the **P** program, the camcorder returns to the Auto mode.
- When recording in dark places a bright light in the scene may cause a vertical light bar (“smear”) to appear. This is a normal feature of camcorders.



## Easy Recording

The simplest way to use the camcorder is with the program selector set to the  position. The camcorder will take care of focus, exposure and other adjustments, leaving you free to point and shoot.



## Auto

This is the same as the Easy Recording program, except that you now have the option of using any of the camcorder's manual functions.



## Sports

This program is useful for recording high-speed sports scenes in brightly lit conditions. Normal playback will be slightly jerky, but you will get clear images which can be analysed frame by frame during slow or paused playback.



## Portrait

Use this program outdoors to make subjects stand out from a softened foreground and background. It works well for still-lives and close-ups. The effect is most noticeable when the zoom position is between the middle range and the telephoto end. Focus manually for maximum accuracy, and be careful when recording action scenes, as this program may cause fast moving objects to shudder.





## Spotlight

This program is designed for recording spotlight scenes, such as on a stage. The exposure is automatically adjusted for glare-free recordings of subjects lit by a concentrated light source.



## Sand & Snow

Use this program in places where the background is so bright that the subject appears underexposed in the display — a sunny beach or ski resort, for example. You may notice some shudder when recording moving subjects.



## Low Light







This program allows you to record in dimly lit places. It is generally best used for close-ups of slow or stationary subjects, as moving subjects may leave a trailing after-image. However, you can take advantage of this to create special effects, by rapid zooming or by panning along with a moving subject. Picture quality will not be as good as in normal lighting conditions, and autofocus may not work as well as usual.





## Using Digital Effects

Use the camcorder's digital effects for more interesting productions.

E



- **Faders:** Start or end scenes on a tape with a fade to or from black (  61). Fade Trigger, Wipe , Stripe , Stripe , Checker, Window
- **Effects:** Add flavour to your recordings (  62). Negative, Art, Black and White, Sepia, Mosaic
- **Multi-image Screen:** Divides the display to show 4, 9 or 16 still photos. Has 3 transition speed options: fast, moderate and slow (  65).

### Availability of digital effects in TAPE CAMERA mode only

Recording Program	 (Easy Recording)		 (Program AE)	
	Movie	Photo	Movie	Photo
Faders				×
Effects		×	○	○
Multi-image Screen				○

○ : Available    × : Not available

#### Notes:

- When you do not want to use digital effects, press the DIGITAL EFFECTS button and select D.EFFECT  from the digital effects menu. Press the DIGITAL EFFECTS button to close the menu.
- The camcorder remembers your chosen digital effect setting until you change it.
- If you slide the program selector to  (Easy Recording) while the digital effect display is flashing, it will disappear from the display and reappear when you return to  (program AE) mode.
- The digital effect display will flash for 2 seconds after setting, even if DISPLAYS is set to OFF in the menu.

## Faders

### Fade Trigger (FADE-T)

When you start recording, the scene gradually fades in from a black screen.

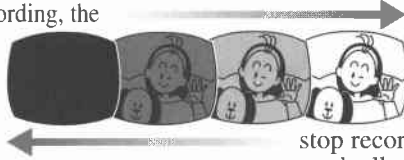

When you stop recording, it gradually fades out.

### Vertical Wipe (WIPE II)

When you start recording, the picture begins as a thin vertical line in the centre of the screen which gradually expands sideways until it fills the whole of the screen.

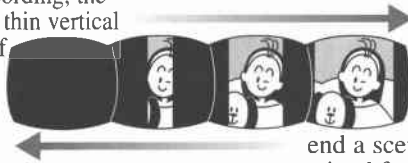

When you end a scene, the image is wiped from both sides of the screen.

### Vertical stripe (STRIPE II)

When you start recording, vertical stripes appear from the top and bottom of the screen, and the scene gradually appears from the centre of the screen.

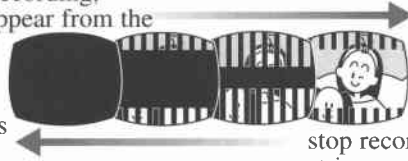

When you stop recording, the stripes appear from the top and bottom of the screen, and the scene gradually becomes black.

### Horizontal stripe (STRIPE =)

When you start recording, horizontal stripes appear from the left and right of the screen, and the scene gradually appears from the centre of the screen.

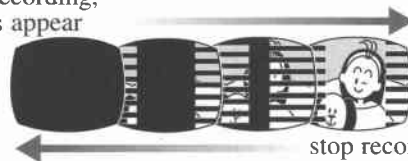

When you stop recording, the stripes appear from the left and right of the screen, and the scene gradually becomes black.

## Checker (CHECKER)

When you start recording, a check pattern appear from the top and bottom of the screen, and the scene gradually appears from the centre of the screen.

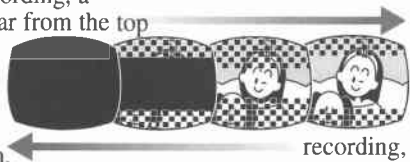

When you stop recording, the check pattern appears from the top and bottom of the screen, and the scene gradually becomes black.

## Window (WINDOW)

When you start recording, the scene you are shooting gradually appears from the centre of the black screen.

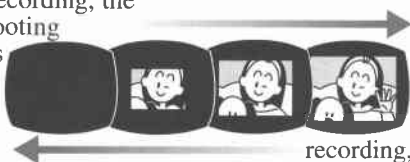

When you stop recording, the black frame gradually increases towards the centre of the screen, and the screen gradually becomes black.

## Effects

### Negative (NEGATIVE)

Makes the image look like negative film.

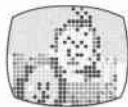

### Mosaic (MOSAIC)

Blurs the image by enlarging the size of some pixels.



### Sepia (SEPIA)

Makes a monochrome image with a brownish tint.



### Art (ART)

Adds a paint-like effect, called solarization, to the image.

### Black and White (BLK & WHT)

Makes the image black and white.

Digital effects can be set with the controls on the body of the camcorder or the wireless controller. Pressing the ▲/▼ buttons on the wireless controller correspond to turning the selector dial up and down, and pressing the SET button corresponds to pressing the selector dial in.

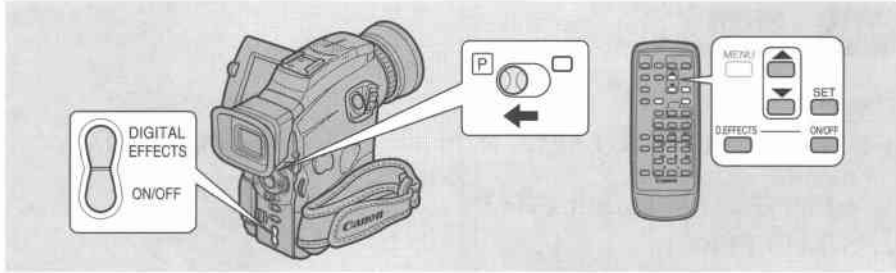

## Operating faders



Sound and image fade together.

When operating faders, make sure the program selector is set to **P**.

TAPE + CAMERA

### Select fader

1. Press the **DIGITAL EFFECTS** button to open the digital effects menu.
  - D.EFFECT **OFF**, FADER, EFFECT and MULTI-S appear.
2. Select **FADER**.
  - FADE-T, WIPE **||**, STRIPE **||**, STRIPE **=**, CHECKER, WINDOW settings appear.
3. Select the desired setting.
  - You return to the digital effects menu.
4. Press the **DIGITAL EFFECTS** button to close the menu.
  - The name of your selected fader flashes in the display.

### Fader on/off

5. Press the **ON/OFF** button.
  - The name of your selection stops flashing.
  - Each time you press the **ON/OFF** button, the chosen fader is activated (display lights continuously) or deactivated (display flashes).
6. **Fade in-** Press the start/stop button.  
**Fade out-** Press the start/stop button.

## Operating effects



Sound records normally.

When operating effects, make sure the program selector is set to **P**.

TAPE + CAMERA

Select effect

1. **Press the DIGITAL EFFECTS button to open the digital effects menu.**
  - D.EFFECT **OFF**, FADER, EFFECT and MULTI-S appear.
2. **Select EFFECT.**
  - NEGATIVE, ART, BLK&WHT, SEPIA, MOSAIC settings appear.
3. **Select the desired setting.**
  - You return to the digital effects menu.
4. **Press the DIGITAL EFFECTS button to close the menu.**
  - The menu disappears and the name of your selected setting flashes in the display.

Effect on/off

5. **Press the ON/OFF button.**
  - The name of your selection stops flashing and takes effect on the display.
  - Each time you press the ON/OFF button, the chosen effect is activated or deactivated.



### Note:

- When MOSAIC is selected, you cannot use the digital zoom.

## Using the Multi-Image Screen

Divides your display image into 4, 9 or 16 smaller images with the Image Capture feature. With this feature, the camcorder captures the current scene being shot or replayed. Choose the transition speed — fast (every 4 frames), moderate (every 6 frames) or slow (every 8 frames) — at which to capture a moving subject, such as a person playing tennis or golf. Sound is recorded normally.



4 images

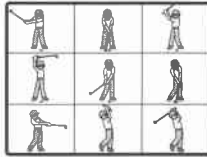

9 images

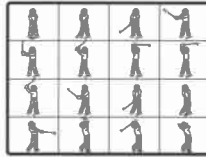

16 images

### Operating the multi-image screen



When operating the multi-image screen, make sure the program selector is set to **P**.

TAPE + CAMERA

#### Select multi-image screen

1. Press the **DIGITAL EFFECTS** button to open the digital effects menu.
  - D.EFFECT **OFF**, FADER, EFFECT and MULTI-S appear.
2. Select **MULTI-S**.
  - S. SPEED and S. SPLIT settings appear.
3. Select **S. SPEED**.
  - FAST, MODERATE and SLOW settings appear.
4. Select the desired setting.
  - You return to the digital effects menu.
5. Select **MULTI-S** again.
  - S. SPEED and S. SPLIT settings appear.
6. Select **S. SPLIT**.
  - 4, 9, 16 settings appear.
7. Select the desired setting.
  - You return to the digital effects menu.
8. Press the **DIGITAL EFFECTS** button to close the menu.
  - The digital effects menu disappears.
  - MULTI-S flashes in the display.

**Multi-image screen on/off****9. Press the ON/OFF button.**

- MULTI-S stops flashing.
- The camcorder will capture the indicated number of images at the indicated speed.

**10. Press the start/stop button to begin recording.**

- The multi-image screen is recorded to the tape.

**Notes:**

- You can operate the multi-image screen from record or record pause mode.
- After all the images have been captured, press the ON/OFF button quickly to cancel the multi-image screen.
- You cannot use digital zoom when the multi-image screen is set.



## Audio Recording

### Selecting the audio mode



MVX1i/MVX1i can record sound in two audio modes — 16-bit and 12-bit. The 16-bit mode produces the higher sound quality (slightly superior to CD) while the 12-bit mode records on 2 channels (stereo 1), leaving 2 channels free (stereo 2) for you to add new sound at a later date.

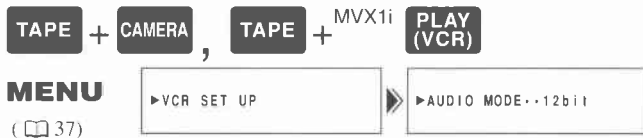

To switch to the 16-bit mode, open the menu and select VCR SET UP. Then select AUDIO MODE, set it to “16 bit” and close the menu.

- “16 bit” is shown in the display for approximately 4 seconds.

#### Notes:

- For details on adding new sound, see p. 95.
- For details of playing back a tape that has new sound on stereo 2, see p. 100.

#### MVX1i only

- When you record to the MVX1i from a camcorder with DV terminal outputs, the audio mode becomes automatically set to 12 bit.
- When the recording mode is set to **SP** or **LP** mode, the audio mode becomes automatically set to 12 bit (1 channel only).
- In TAPE PLAY (VCR) mode, the audio mode takes effect when doing analog line-in recording or AV insert. When you do DV in recording, the setting automatically changes to that of the digital device connected to the camcorder.

### External microphone

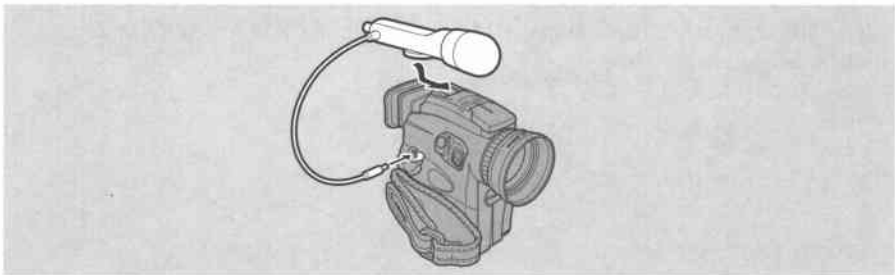

For greater creative control over audio recording, you can connect an external microphone to the camcorder via the MIC terminal. When using the MIC terminal, use a microphone with a built-in power supply (condenser microphone). It is possible to connect almost any stereo microphone with a plug diameter of 3.5 mm ( $1/8$  in), however, their audio levels will be different from that of the built-in microphone.

**Notes:**

- When using an external microphone, use a microphone cable not longer than 3 meters to avoid electromagnetic interference.
- For details on using the optional DM-50 microphone, see p. 72.
- Be careful when using long microphones as they may extend into the frame.

**Wind screen**

The camcorder has an automatic wind screen to prevent wind noise from interfering with the sound track. Make sure it's off when you want the microphone to be as sensitive as possible. Use the wind screen when recording in windy places such as the beach or near buildings.

**MENU**

( [ ] 37 )

▶ VCR SET UP

▶▶ WIND SCREEN •• OFF

**To turn it on, open the menu and select VCR SET UP. Then select WIND SCREEN, set it to ON and close the menu.**

- WS **ON** is shown in the display when you turn the wind screen on.

**Notes:**

- The wind screen can be used for audio dubbing with the built-in microphone in TAPE PLAY (MVX1i: TAPE PLAY (VCR)) mode as well as recording.
  - \* For MVX1i: Only when AUDIO DUB. is set to MIC. IN in VCR SET UP submenu.
- The wind screen does not operate when an external microphone is connected to the MIC terminal or the optional DM-50 microphone is connected to the advanced accessory shoe.

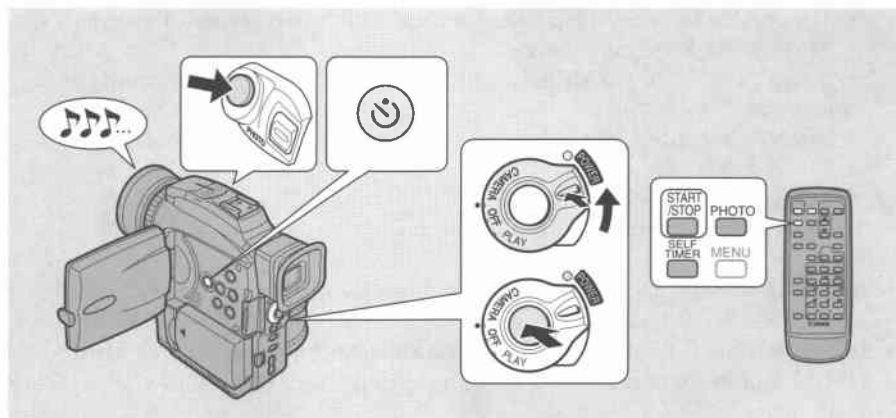

This is useful when you want to include yourself in the picture when recording movies or still photographs.

**TAPE + CAMERA** , **CARD + CAMERA**

1. Press the self-timer button on the body of the camcorder or

**the SELF TIMER button on the wireless controller.**

- SELF-T appears in the display.
- To have the subject monitor recording, rotate the LCD panel 180° ( 26).

For movies

2. Press the start/stop button.



- The camcorder starts to record after a 10-second countdown period (or after 2 seconds when you use the wireless controller). The time remaining counts down in the display (e.g. "5 SEC").
- SELF-T disappears from the display when recording begins.
- The tally lamp starts flashing.

3. Press the start/stop button to end recording.



For stills

2. Press a PHOTO button on the camcorder body or the wireless controller.

- The camcorder automatically adjusts the focus 2 seconds before the countdown is complete. The mark flashes white then turns green after the focus and exposure are set. If you are using the wireless controller, the mark starts flashing immediately after you press the PHOTO button.

- The camcorder takes the picture for approximately 6 seconds (8 seconds in  SP or  LP recording mode).
- If you're in TAPE CAMERA mode, the camcorder returns to record pause mode after recording to a tape. If you're in CARD CAMERA mode, the currently recording image appears after recording onto a memory card.

**Notes:**

- If you have the beep turned on, it sounds each time the tally lamp flashes before recording.
- To cancel the self-timer before the countdown has begun, press the  SELF TIMER button.
- To cancel the self-timer once the countdown has begun, press the  SELF TIMER button, start/stop if you're shooting movies, or PHOTO if you're taking a still image.

## Using the VL-3 Video Light (optional)

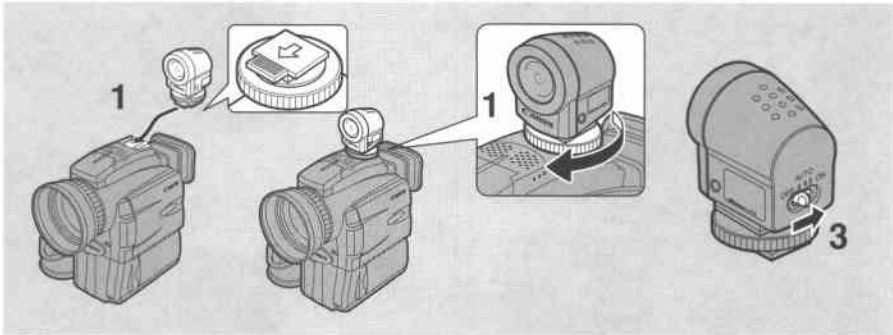

When recording in dark rooms, attach the Video Light to the camcorder's advanced accessory shoe. The Video Light is powered by the same power source as the camcorder.

Also refer to the VL-3 Video Light instructions.

Turn the camcorder's power off before attaching/removing the Video Light.

### 1. Slide the Video Light onto the accessory shoe and tighten with the shoe lock.

- Slide in the direction of the arrow on the bottom of the Video Light until it clicks securely into place.
- Make sure that the light does not come disconnected when turning the shoe lock.

### 2. Set the camcorder to TAPE CAMERA mode or CARD CAMERA mode.

### 3. Turn the Video Light's power switch to AUTO or ON.

- **C** (Connection) appears in the display.
- **ON**: The Video Light stays on.
- **AUTO**: The Video Light turns on/off automatically according to the level of brightness of the shooting conditions (except when exposure is locked).



### Caution:

- Be careful not to touch the bulb or the surrounding area during or immediately after use; it becomes very hot. Keep the Video Light away from flammable or plastic materials.
- Do not look directly at the bulb while the Video Light is on.
- Never carry the camcorder holding the Video Light.
- When the built-in flash rises, the light of the Video Light is interfered by it.

## Using the DM-50 Microphone (optional)

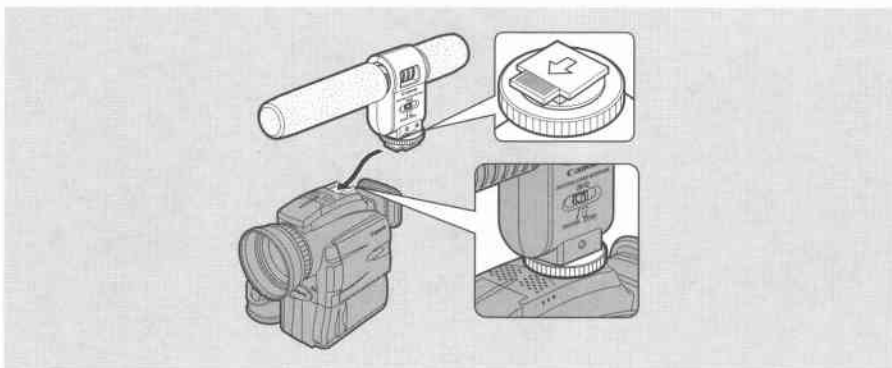
E



The highly sensitive Directional Stereo Microphone DM-50 has been designed exclusively for camcorders equipped with an advanced accessory shoe . It is powered by the camcorder's power supply. Use during cassette recording or audio dubbing ( 95).

Refer to the DM-50's instructions for further details.

Turn the camcorder's power off before attaching/removing the microphone.

- 1. Slide the microphone onto the accessory shoe and tighten with the shoe lock.**
  - Slide in the direction of the arrow on the bottom of the microphone until it clicks securely into place.
  - Make sure that the microphone does not come disconnected when turning the shoe lock.
- 2. Set the camcorder to TAPE CAMERA mode.**
  -  (Connection) appears in the display.
- 3. Set the microphone's directivity switch.**

**SHOTGUN:** Clearly picks up sound arriving from the front of the microphone (monaural).

**STEREO1:** Picks up sound arriving from the front of, as well as sound surrounding the microphone.

**STEREO2:** Picks up sound surrounding the microphone in a wider range than STEREO 1.

### Notes:

- Never carry the camcorder holding the microphone.
- The DM-50 will not pick up any sound if another microphone is attached to the camcorder's microphone terminal.

## Adjusting Exposure Manually

### Exposure lock



TAPE + CAMERA , CARD + CAMERA

When you are recording in situations where the lighting may change suddenly, you can lock the exposure at the current level in order to control the brightness of the image.

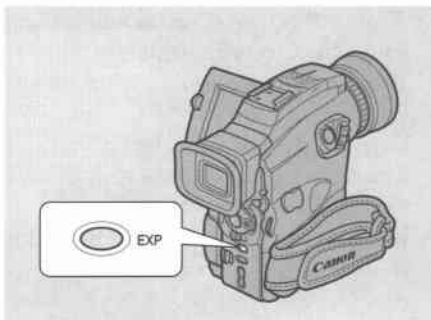

To lock the exposure, press the EXP button. Press it again to return to auto exposure.

### Exposure adjustment



TAPE + CAMERA , CARD + CAMERA

When the exposure is locked, you can adjust it manually, making the picture brighter or darker in order to deal with difficult lighting conditions. The camera's iris can be manually set to any position from fully closed to fully open.

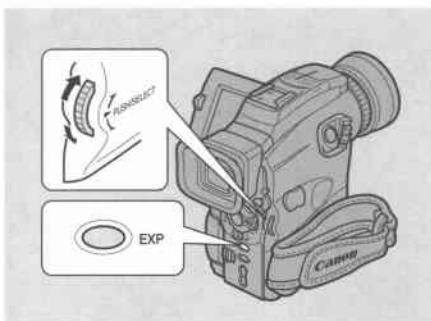

To make the recorded image brighter, turn the selector dial upwards (to a maximum of +11). This may be necessary if the background is very bright, or if the subject is lit from behind.

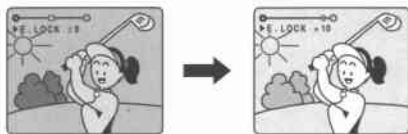

To make the recorded image darker, turn the selector dial downwards (to a minimum of -11). This may be necessary if the background is very dark, or if the subject is spotlighted.



**Notes:**

- You cannot adjust the exposure without the ► mark before E.LOCK in the display. Push the EXP button so that ► appears before E.LOCK. Then you can adjust the exposure manually.
- The standard exposure level depends on which recording program you have selected.
- Exposure lock is cancelled if you change recording programs.
- You cannot use exposure lock or adjustment when the program selector is set to the □ (Easy Recording) position.
- If you zoom while the exposure is locked, the brightness of the scene may change.



## Setting the Shutter Speed



Set the shutter speed manually to take stable shots of quickly moving subjects.

TAPE + CAMERA , CARD + CAMERA

**MENU**  
( 37)

▶CAM.SET UP

▶▶SHUTTER.....AUTO

1. Make sure the camcorder is set to the (program AE) mode.
2. Press the selector dial in and choose AUTO from the program menu.
3. Open the menu and select CAM.SET UP.
4. Select SHUTTER.
5. Press the selector dial in to select the desired shutter speed.

<u>TAPE</u>		<u>CARD</u>
AUTO		AUTO
1/50	↑ slower ↑	1/50
1/120		1/120
1/250		1/250
1/500		1/500
1/1000		
1/2000		
1/4000		
1/8000	↓ faster ↓	

- Only shutter speeds up to 1/500 are available when using a memory card.

6. Close the menu.

## Guidelines for shooting using high shutter speeds

- When shooting with a shutter speed of 1/1000 or higher, do not shoot the sun directly.

## Recommended shutter speeds when shooting:

- People doing outdoor sports such as golf or tennis



1/2000 or 1/4000  
(or 1/8000 to freeze the action even more clearly)

- Moving cars or trains or other rapidly moving vehicles such as roller coasters



1/1000, 1/500 or 1/250

- People doing indoor sports such as basketball



1/120

### Notes:

- You are unable to set the shutter speed in any recording program other than AUTO.
- The image may not appear smooth when a high shutter speed is set.
- The camcorder returns to the auto shutter setting when you slide the program selector to  (Easy Recording), or change the recording program.
- If you set the shutter speed to 1/1000 or above in TAPE CAMERA mode and then switch the camcorder to CARD CAMERA mode, the shutter speed will automatically change to 1/500.

## Adjusting Focus Manually

The camcorder can focus automatically. All you have to do is point it, and whatever is in the centre of the display will usually be in sharp focus. If it does not seem to be focusing well, it may be because the subject is not suitable for autofocus.

You can use the manual focusing function for more control over focusing.

### Focus lock



TAPE + CAMERA , CARD + CAMERA

Press the FOCUS button to turn off autofocus. The focus remains locked at the point set by autofocus.

(▶M.FOCUS appears in the display.)

You can now adjust the focus manually with the selector dial. Press the FOCUS button again when you want to return to autofocus.

- If you zoom in on your subject after turning off autofocus, it may not stay in focus. It is generally best to adjust the zoom first, and then the focus.

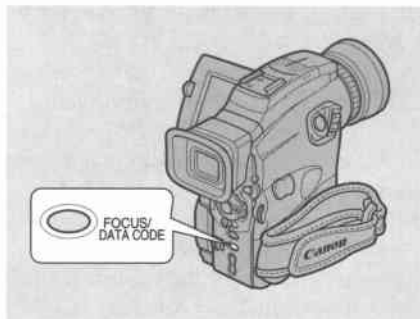

### Manual focus



TAPE + CAMERA , CARD + CAMERA

Use the selector dial to set the focus.

- Turn the selector dial downward to move the focus farther away.
- Turn the selector dial upwards to bring the focus nearer.

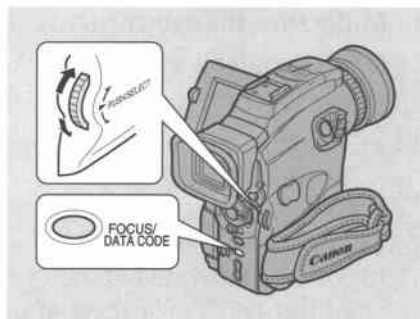

### Notes:

- You cannot adjust the focus without the ▶ mark before M.FOCUS in the display. Push the FOCUS button so that ▶ appears before M.FOCUS. Then you can adjust the focus manually.
- The manual focus setting is cancelled if you select the  (Easy Recording) program.
- When you are using the  (Easy Recording) program, autofocus cannot be turned off.
- See “Troubleshooting” on p. 140 for a list of subjects which may not be suitable for autofocus.

## Setting the White Balance



E

The camcorder's auto white balance system compensates for a wide range of lighting conditions. Although slight variations are unavoidable, colours will appear natural in virtually every situation.

In some cases, you will get better results by setting the white balance yourself, or using one of the two preset modes:

- Indoor Mode
  - Under halogen or studio/video lighting
  - Subject is of one dominant colour
  - Close ups
- Outdoor mode
  - In daylight, especially for close-ups and where the subject is of one dominant colour

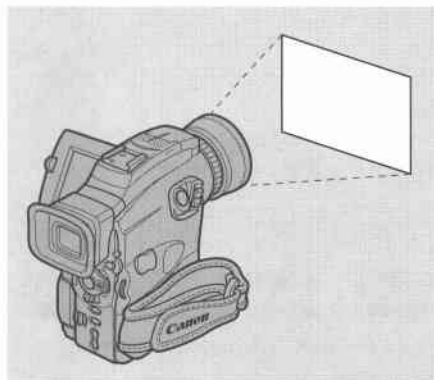

Using the Full  
Range of Features

TAPE + CAMERA , CARD + CAMERA

**MENU**  
( 37 )

▶CAM.SET UP

▶WHITE BAL...AUTO

1. Make sure the camcorder is set to the (program AE) mode.
2. Open the menu and select CAM.SET UP.
3. Select WHITE BAL.
4. a) For the indoor, outdoor or auto settings, press the selector dial in to choose the setting.
  - appears in the display when you set the white balance to indoor/outdoor mode.
- b) To set the white balance yourself, point the camcorder at a white object (such as a sheet of paper) and zoom in until it fills the display. Then press the selector dial in to select SET .
- Make sure to continue pointing the camcorder at the white object until you have finished setting the white balance.
- The display flashes then remains lit.
- Depending on the light source, the flashing may at times continue. The result will remain better than with the auto setting and you can continue recording.
5. Close the menu.

Setting the white balance manually will probably work better than auto white balance when shooting:

Subjects with one dominant colour, such as sky, sea or forest



Close-ups



In rapidly changing lighting conditions



In places lit by certain types of fluorescent or mercury vapour lights



#### Notes:

- Turn the digital zoom off (if necessary) to set a more accurate white balance.
- When one of NEGATIVE, BLK&WHT or SEPIA is activated, you cannot set the white balance.
- If you have set the white balance and lighting conditions change, reset the white balance.
- Try to record with light from a single source. Correct white balance cannot be obtained for two types of lighting at once.
- You cannot set the white balance or choose the indoor/outdoor mode when the program selector is set to the  (Easy Recording) program.
- The white balance returns to the AUTO setting when you slide the program selector to  (Easy Recording).
- When you turn the camcorder on, the white balance returns to AUTO. If you then switch the white balance to SET, the camcorder will remember your last setting.
- During normal outdoor shooting, setting to AUTO may provide better results.

## Displaying Date, Time and Camcorder Data (Data Code)

E

A data code, containing the date and time the recording was made and other camcorder data (shutter speed and exposure settings) is automatically recorded on a special data section of the tape.

- Only the date and time appear in the data code when using a memory card.

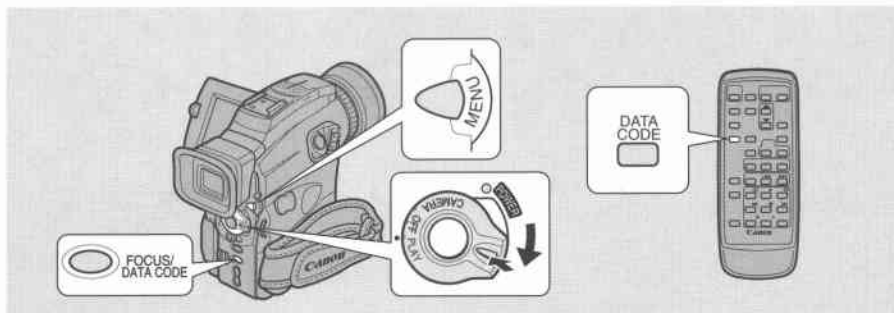

During TAPE PLAY (MVX1i: TAPE PLAY (VCR)) mode, the data code can be displayed or hidden while the camcorder is in play, slow or still mode.

Camcorder data may be displayed as “---” during fast forward, rewind, reverse playback, forward and reverse  $\times 2$  playback.

**Press the DATA CODE button. When using a cassette, press it while the camcorder is in play, slow or still mode.**

- Press it once to display, once more to hide it.

### Selecting date/time

Select whether you want the date, the time, or both to show up on your data code display ( 81).

TAPE + ( **PLAY** / PLAY(VCR) ),    CARD + ( **PLAY** / PLAY(VCR) )

**MENU**  
( 37 )

▶ DISP.SET UP

▶▶ D/TIME SEL..DATE & TIME

**To change the date and time combination, open the menu and select DISP.SET UP. Then select D/TIME SEL, set it to DATE, TIME or DATE & TIME and close the menu.**

## Setting the data code



E

You can also choose to display camcorder data (shutter speed and exposure settings) in cassette data codes.

TAPE + (PLAY/PLAY/VCRI)

**MENU**  
( 37)

▶ DISP. SET UP

▶▶ DATA CODE...DATE/TIME

To change, open the menu and select **DISP.SET UP**. Then select **DATA CODE**, set it to **DATE/TIME**, **CAMERA DATA** or **CAM. & D/T** and close the menu.

Possible data code combinations for cassettes:

DATA CODE (cassette only) D/TIME SEL.	Date/Time	Camera data	Date/Time & Camera data
Date	1. JAN. 2001	F11 1/250	F11 1/250 1. JAN. 2001
Time	12:00:00 AM	F11 1/250	F11 1/250 12:00:00 AM
Date & Time	12:00 AM 1. JAN. 2001	F11 1/250	F11 1/250 12:00 AM 1. JAN. 2001

### Notes:

- The data code will read “--” in the following situations:
  - During playback of a blank section of tape.
  - If the tape was recorded before entering the date and time in the camcorder’s memory.
  - If the tape was recorded on a camcorder without a data code function.
  - If noise or tape damage prevents the data code from being read.
- If a recording made on MVX1/MVX1i is played back on a different DV camcorder, the data code may not be displayed correctly.
- The data code will appear in the display even if DISPLAYS ( 148) has been set to OFF through the menu.

## Six-second auto date



The 6-second auto date appears for 6 seconds to mark the changeover of a day if the tape was being recorded at 12:00 midnight. It also appears for 6 seconds when you start playback and have the data code turned off. The 6-second auto date will adjust for any time zone changes you have indicated.

**TAPE** + **PLAY**  
(PLAY/VCR)

**MENU**  
( 37)



To turn the 6-second auto date on, open the menu and select **DISP.SET UP**. Then select **6SEC. DATE**, set it to **ON** and close the menu.

**Note:**

- When 6SEC.DATE is turned on but **DISPLAYS** ( 148) is turned off, the six-second auto date will still appear for 6 seconds.



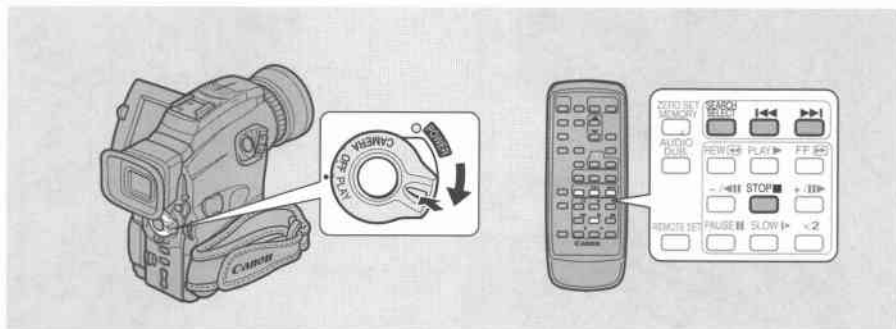

This allows you to move quickly through still pictures recorded anywhere on a tape (photo search) or between different days or areas of recording (date search) on a tape.

**TAPE** + **PLAY**  
(PLAY/VCR)

1. Press the **SEARCH SELECT** button to choose between photo/date search.
  - PHOTO SEARCH or DATE SEARCH is shown in the display for 4 seconds.
2. Press the **◀◀** and **▶▶** buttons to move backwards or forwards through the still pictures or between different days of recording.
  - Press once to move to the start of the previous/next still picture or day on the tape.
  - You can press more than once to move to the corresponding still picture or day (up to a maximum of 10 times), e.g. press the **▶▶** button 5 times to move forward 5 still pictures or days.
  - PHOTO SEARCH/DATE SEARCH appears in the middle of the display alongside the **◀◀** or **▶▶** mark and number to search through. You can change direction easily by pressing the button for the opposite direction.

**Notes:**

- Press **■** (stop) to stop mid-search.
- If you begin a search very close to the start of a recorded still picture during photo search, the camcorder may skip straight past it.
- When you have set the area for the World Clock, date search also looks for the change in date based on the adjusted time.
- A date/area cannot be identified if the total recording time on that day/area was less than 1 minute.
- Date search playback may start just before or after the beginning of the located section.
- If the data code is not displayed correctly you will not be able to operate the date search correctly.



E

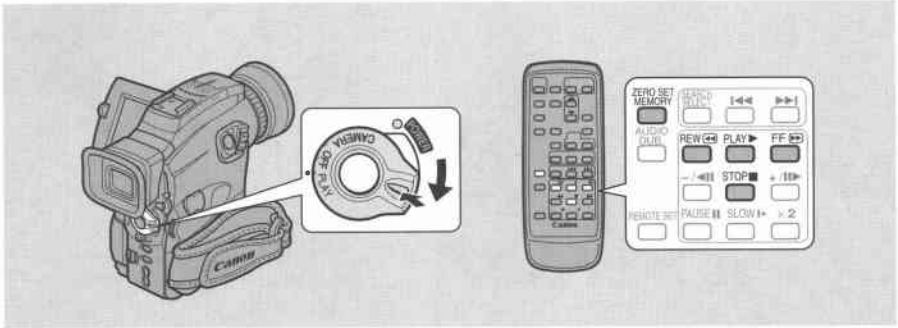

Use the wireless controller to mark a point on a tape that you want to return to following playback.

TAPE + CAMERA, TAPE + (PLAY / PLAY/VCRI)

Using the Full  
Range of Features

**1. Press the ZERO SET MEMORY button on the wireless controller during playback at a point you want to return to later.**

- The time code is replaced by a tape counter that is set to zero with the **M** indication.
- Press the ZERO SET MEMORY button once more to cancel the zero set memory.

**2. When you have finished playback, fast forward or rewind the tape. The tape stops automatically when it reaches the zero set position.**

- **RTN▶▶** or **◀◀RTN** appears in the display.
- The tape counter with **M** indication disappears from the display and the time code reappears.

**Notes:**

- The zero set memory may not function correctly where there is a break between recordings on the tape.
- You can also use zero set memory to mark a position on a tape in TAPE CAMERA mode. When you then play back the tape, pressing rewind will take you back to the pre-marked position.
- If you remove the tape while the zero set memory is set, the memory is cancelled and the tape counter reverts to time code.
- The camcorder remembers your setting even if you turn it off and back on again or move the program selector.

## Editing to a VCR

By connecting the camcorder to a VCR, you can edit your recordings in order to remove unwanted scenes — or combine different shots to create your own video productions.

E

### Preparations

1. **Connect the camcorder to the VCR.**
  - See “Connections for Playback on a TV Screen” on p. 31.
2. **Prepare the TV and VCR.**
  - Turn on the TV and set the TV/VIDEO selector to VIDEO.
  - Turn on the VCR, and set its input selector to LINE. Load a blank cassette, and put the VCR in record pause mode.
  - See your TV and VCR instruction manuals for details.
3. **Turn the camcorder’s POWER switch to PLAY (MVX1i: PLAY (VCR)), and move the camcorder’s TAPE/CARD switch to TAPE.**
4. **Load your recorded cassette.**

### Editing



1. **Find a point on your recorded cassette slightly before the section you want to copy.**
2. **Start to play it back while you monitor the picture on the TV.**
3. **Start recording on the VCR as soon as the section you want to copy appears on the screen.**
4. **Pause the VCR at the end of the section you want to copy, then stop playback on the camcorder.**
5. **Repeat steps 1 to 4 until your edited recording is complete.**



#### Note:

- The quality of the edited tape will be slightly lower than that of the original.

### Ⓛ (LANC) terminal

The Ⓛ terminal allows you to connect the camcorder to equipment. Some buttons on editing equipment may operate differently from those on the camcorder.



#### Notes:

- Ⓛ (LANC) is a trademark. It stands for Local Application Control Bus System.
- We cannot guarantee the results when connecting to equipment not bearing the LANC Ⓛ symbol.

## MVX1

Digital video equipment fitted with the DV terminal lets you edit, copy and transfer data digitally, with virtually no generation loss in image and sound quality.

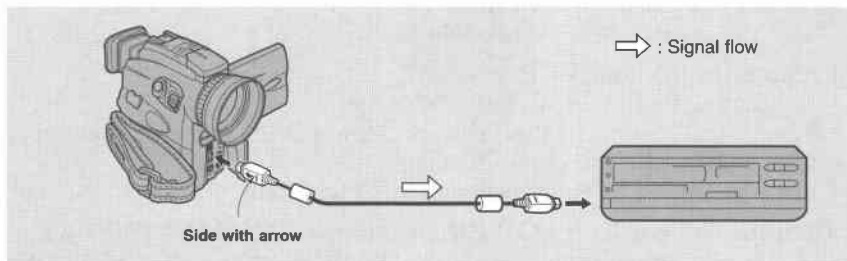

### Preparations

1. **Connect the camcorder and the other digital device.**
  - Connect the Canon CV-150F DV cable (optional) with the side of the plug marked with the arrow facing as shown above.
2. **Prepare the other device.**
  - Load a blank cassette, and put the other device in record pause mode.
  - See its instruction manual for details.
3. **Turn the camcorder's POWER switch to PLAY and move the camcorder's TAPE/CARD switch to TAPE.**
4. **Load a recorded cassette.**

### Dubbing



1. **Find a point on your recorded cassette slightly before the section you want to dub.**
2. **Press the camcorder's play button.**
  - Playback starts.
3. **Start recording on the other device as the section you want to copy appears on the screen.**
4. **When you get to the point where you want to stop dubbing, press the stop button or the pause button.**
  - Playback stops.

#### **Note:**

- Blanks between recordings on the playback tape are recorded as anomalous images on the tape that is being recorded to.

# MVX1i

The MVX1i is equipped with the DV Recording function.

Digital video equipment fitted with the DV terminal lets you edit, copy and transfer data digitally, with virtually no generation loss in image and sound quality. The DV terminal is for both line-in and line-out, since a single DV cable can handle data in both directions.

- If a digital VCR is connected and an anomalous signal is sent from the VCR, the images recorded on the tape may also be anomalous (although it may not appear so on the TV image), or not recorded at all.
- You are unable to dub tapes recorded with the copyright protective signal.

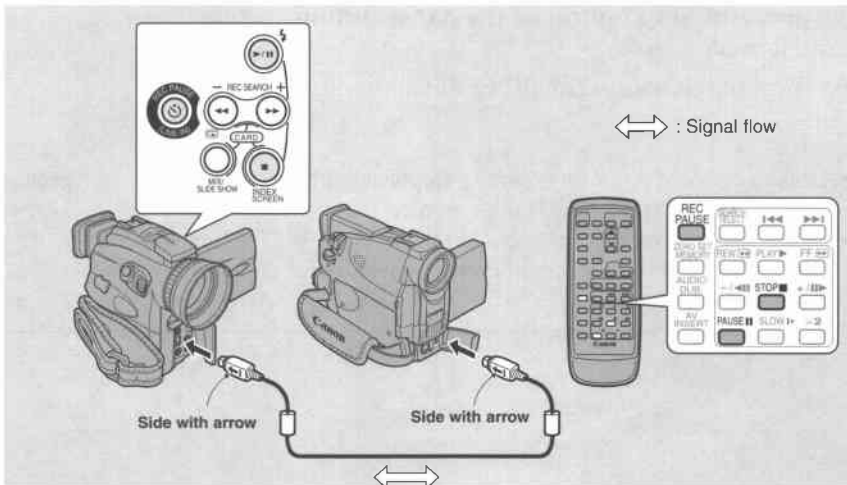

## Preparations



### Example dubbing to the camcorder

1. **Connect the camcorder and the other digital device.**
  - Connect the Canon CV-150F DV cable (optional) with the sides of the plugs marked with the arrows facing as shown above.
2. **Prepare the other device.**
  - Turn on the power and load a recorded cassette.
3. **Turn the camcorder's POWER switch to PLAY (VCR), and move the camcorder's TAPE/CARD switch to TAPE.**
  - DV IN appears in the display.
4. **Load a blank cassette.**



1. Find a point on your recorded cassette slightly before the section you want to copy and set it to playback pause mode.
2. Press the camcorder's REC PAUSE button.
  - The camcorder enters record pause mode.
3. Start playback on the other digital device while you monitor the picture.
4. Press the pause button.
  - Recording starts.
5. When you get to the point where you want to stop recording, press the stop button or the pause button.
  - Recording stops.
6. Stop playback on the other device.

**Notes:**

- Blanks between recordings on the playback tape are recorded as anomalous images on the tape that is being recorded to.
- When playing back a tape recorded in  SP or  LP mode with the camcorder, you cannot record correctly with other digital devices not equipped with that mode.

## Concerning copyrighting

E

### Copyright precaution

Certain pre-recorded video tapes, films and other materials, as well as some television programmes are copyrighted. Unauthorized recording of these materials may violate copyright protection laws.

### Copyright signals

When playing back:

If you try to play back a tape that contains copyright control signals for the protection of software, "COPYRIGHT PROTECTED PLAYBACK IS RESTRICTED" appears in the display for a few seconds and then the camcorder displays a blank blue screen; you cannot view the contents of the tape.

When recording:

If you try to record from software that contains copyright control signals for the protection of software, "COPYRIGHT PROTECTED DUBBING RESTRICTED" appears in the display; you cannot record the contents of the software.

You cannot record copyright protection signals to a tape using this camcorder.

## Recording from a VCR, TV or Analog Camcorder- Analog Line-in (MVX1i only)

E

You can record a video played on your VCR or analog camcorder (for digital camcorders, see p. 87) or a TV program onto a tape in the MVX1i, if the TV or other device has audio/video outputs.

- If an anomalous signal is sent from the TV or VCR, the images recorded on the tape may also be anomalous (although it may not appear so on the TV image), not recorded at all, or COPYRIGHT PROTECTED DUBBING RESTRICTED may appear in the display.
- You are unable to dub tapes recorded with the copyright protective signal.
- For higher picture quality, we recommend using the S-150 S-video cable when doing analog line-in recording.

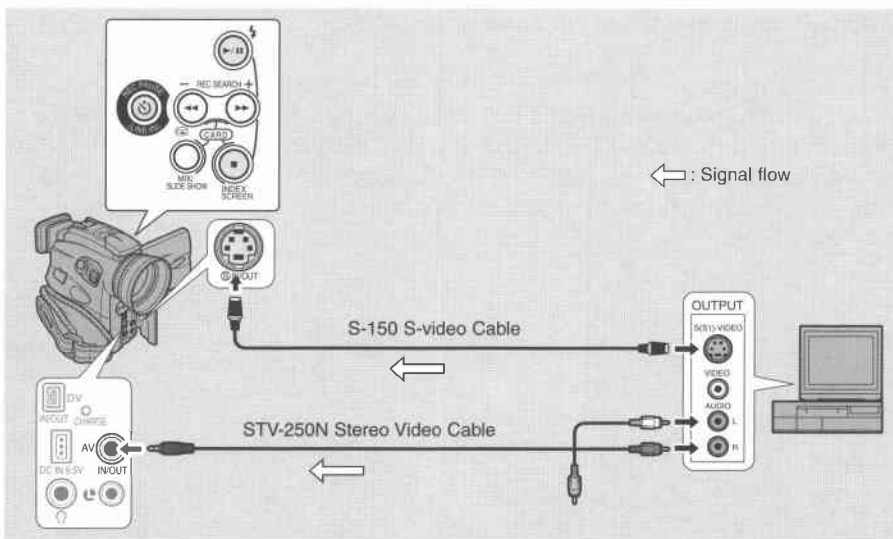

Editing

### Preparations

#### Example recording from a VCR

1. **Connect the camcorder to the VCR.**
2. **Prepare the device.**
  - Set the TV/Video selector on the television to Video. For further details, see "Connections for Playback on a TV Screen" on p. 31.
  - Turn on the VCR. Load your recorded cassette, and put the VCR in playback pause mode.
  - See your TV and VCR instruction manuals for details.
3. **Turn the camcorder's POWER switch to to PLAY(VCR), and move the camcorder's TAPE/CARD switch to TAPE.**
4. **Load a blank cassette.**





1. Find a point on your recorded cassette slightly before the section you want to copy and set it to playback pause mode.
2. Press the **REC PAUSE** button.
  - S-video and AV IN/OUT terminals work as input terminals.
  - The camcorder enters record pause mode.
3. Start playback on the other device or turn on the TV to see the desired program while you monitor the picture.
4. Press the pause button.
  - Recording starts.
5. When you get to the point where you want to stop recording, press the stop button or the pause button.
  - Recording stops.
6. Stop playback on the other device.

**Note:**

- You can monitor the picture in the viewfinder or LCD.

# Recording Over Existing Scenes — AV Insert Editing (MVX1i only)

E

You can insert new scenes from your VCR or other camcorder onto your pre-recorded tape using the MVX1i's analog line-in or DV in terminals. Original video and audio will be replaced with the new video and audio.

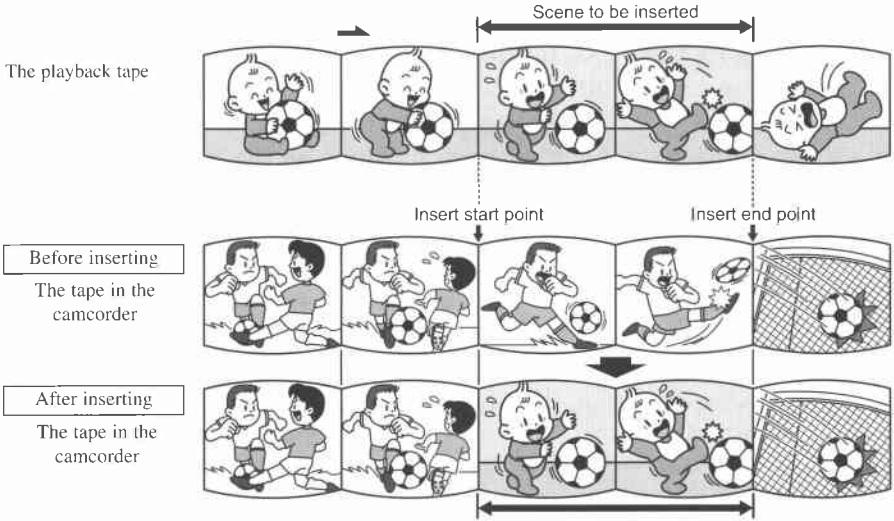

The video and audio of the new scene replace that of the old.

Editing

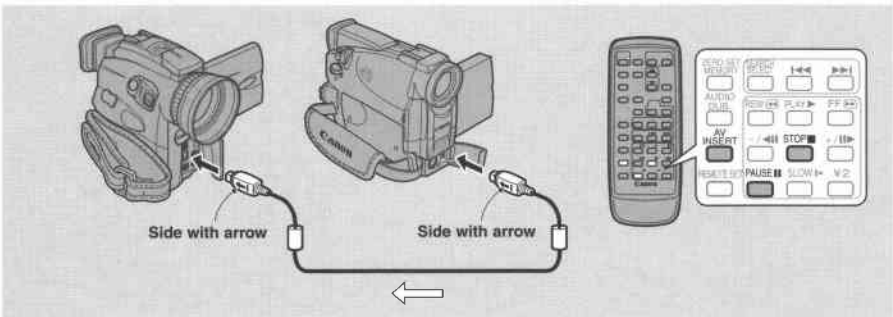
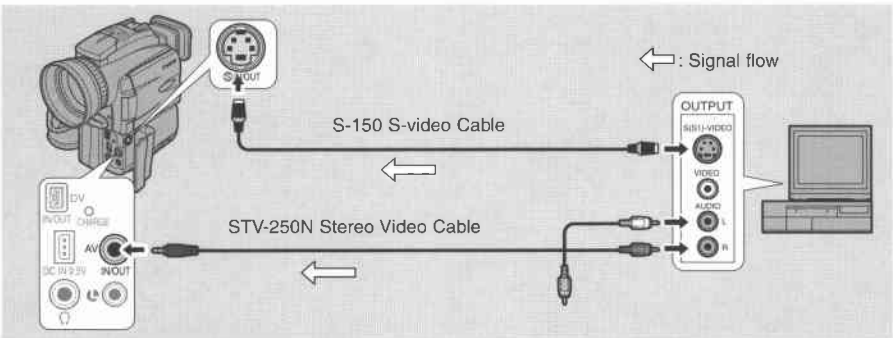

### The tape in the MVX1i:

When using the MVX1i's AV insert function, only record to tapes recorded in SP mode.

If there are non-recorded portions or portions recorded in a mode other than SP mode on the tape, recording will stop.

### The playback tape:

Use only tapes without non-recorded portions.

If there are non-recorded portions or changes in the recording mode, you may not be able to insert AV correctly.

You cannot insert AV in the following cases:

- The playback tape has been poorly recorded.
- During special playback: fast forward playback, rewind playback or slow playback etc. (analog only).

### TV:

You cannot insert AV from a TV program with anomalous synchronized signals, such as when the program itself received poor signals.

#### Example recording from a VCR

- 1. Connect the camcorder to the VCR.**
- 2. Prepare the VCR and TV.**
  - Set the TV/Video selector on the television to Video. For further details, see "Connections for Playback on a TV Screen" on p. 31.
  - Turn on the VCR and load a recorded cassette.
  - See TV and VCR instruction manuals for details.
- 3. Turn the camcorder's POWER switch to PLAY (VCR) and load a recorded cassette.**
  - Make sure the REC/SAVE tab on the cassette has been slid to REC (closed position).
- 4. Move the camcorder's TAPE/CARD switch to TAPE.**



1. **On the VCR, locate a point 3 seconds before the scene to be inserted. Set the VCR to playback pause mode.**
2. **On the camcorder, press PLAY and locate the recording start point. Set the camcorder to playback pause mode.**
  - You can use the playback buttons on the body of the camcorder or the special playback functions on the wireless controller in the same way as in playback mode.
3. **Press the AV INSERT button.**
  - AV INSERT and ●|| appear in the display.
4. **Play back the cassette in the VCR.**
5. **To start inserting, press the PAUSE button on the camcorder.**
  - ●|| changes to ●.
6. **To stop inserting, press the STOP button on the camcorder.**
  - Inserting stops and AV INSERT disappears from the display. The camcorder returns to stop mode.
  - If instead of pressing STOP you press PAUSE, the camcorder returns to the AV insert pause mode.
  - If you set the zero set memory at the position on the tape where you want to stop inserting, every time you return to that point, the camcorder will cancel its AV inserting and enter stop mode.
7. **Stop playback on the VCR.**

## Audio Dubbing

### - For MVX1 (For MVX1i, 97).



You can add sound to the original sound on a pre-recorded tape recorded in the SP mode with 12-bit sound. Use the internal or an external microphone. The original sound will not be erased.

For best results, add sound to tapes that have been recorded with this camcorder in SP mode with 12-bit sound. If there are non-recorded portions on the tape, or portions recorded in a mode other than SP mode, or with 16-bit or 12-bit, 4-channel sound, dubbing will stop. You cannot dub audio onto a tape recorded with 12-bit and 16-bit sound intermingled.

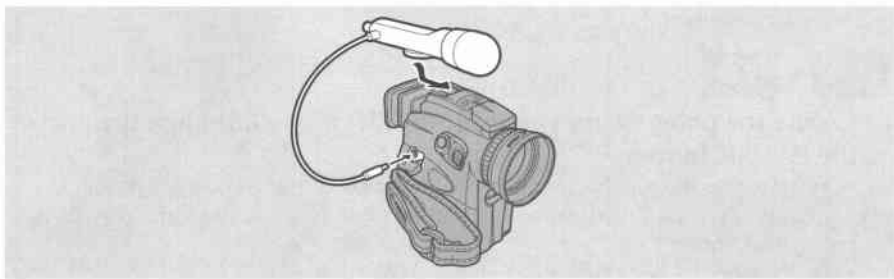
### To connect an external microphone:



### Notes:

- **When using an external microphone** → Connect it to the microphone terminal.
- **When using the DM-50 microphone** → Make sure nothing is connected to the microphone terminal.
- **When using the built-in microphone** → Make sure nothing is connected to either the microphone terminal or the accessory shoe.
- To use your TV to monitor video, connect the S-video terminal ( 32) or the AV terminal (use only the video plug) to your TV. You can monitor the sound with headphones ( 30).

## Preparations

Turn the camcorder's POWER switch to PLAY and move the camcorder's TAPE/CARD switch to TAPE. Load a recorded cassette.

- Make sure the REC/SAVE tab on the cassette has been slid to REC (closed position).

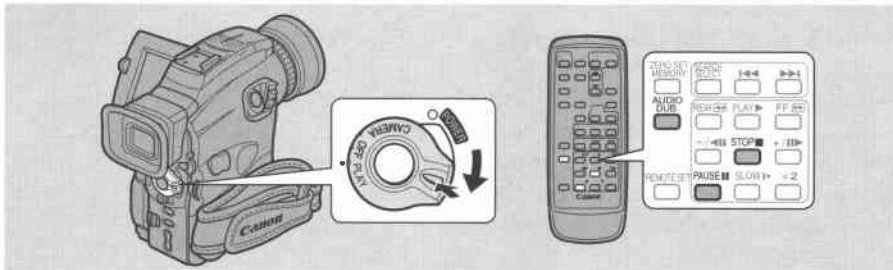

Do not connect/disconnect any cables to/from the camcorder when dubbing audio or preparing to dub audio.

**TAPE** + **PLAY**

**1. Locate the point where you want to start audio dubbing, then press the PAUSE button.**

- You can use the playback buttons on the body of the camcorder or the special playback functions on the wireless controller in the same way as in playback mode.
- The camcorder becomes set to playback pause mode.

**2. Press the AUDIO DUB. button.**

- AUDIO DUB. and appear on the display.

**3. Press the PAUSE button.**

- Audio dubbing starts.
- Direct your voice into the microphone.
- changes to .

**4. When you get to the point where you want to stop dubbing, press the STOP button.**

- Audio dubbing stops and AUDIO DUB. disappears from the display.
- The camcorder returns to stop mode.
- You can also set zero set memory ( 84) at the place you want to stop audio dubbing, then every time you return to that position, audio dubbing will cancel.
- If instead of pressing STOP you press PAUSE, the camcorder will return to the playback pause mode.

**Notes:**

- You can not use the DV terminal while adding sound.
- You might want to adjust the audio mix ( 100) when playing back a tape with added sound.
- There may be a loss of sound quality if you add sound to a tape recorded on a camcorder other than the MVX1.
- After adding sound 3 or more times to the same place on a tape, there may be some loss in sound quality.

### - For MVX1i (For MVX1, □ 95).

You can add sound to the original sound on a pre-recorded tape from audio products (AUDIO IN) or with the internal or external microphone (MIC. IN). The original sound will not be erased. For best results, add sound to tapes that have been recorded with this camcorder in SP mode with 12-bit sound. If there are non-recorded portions on the tape, or portions recorded in a mode other than SP mode, or with 16-bit or 12-bit, 4-channel sound, dubbing will stop. If your tape hasn't been recorded in SP mode with 12-bit sound, we recommend dubbing your original tape onto a blank tape using the MVX1i's analog line-in function, then dubbing audio onto the new tape. Make absolutely sure to set the audio mode of the new tape to 12-bit and the recording mode to SP.

### To connect other audio equipment:

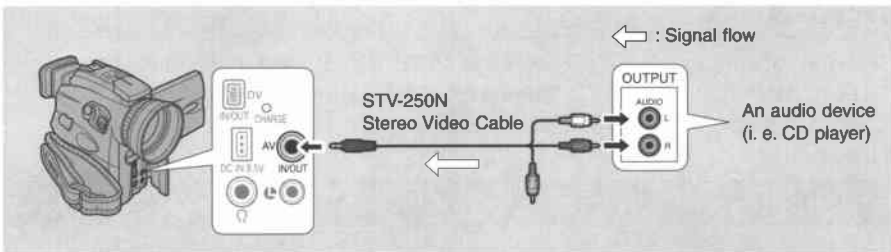



### Notes:

- Do not use the yellow video terminal.
- The AV terminal doesn't put out any video, so connect the S-video terminals and check your TV, or check the LCD or the viewfinder as you add new sound. Always check the new sound with the speaker or the headphones.

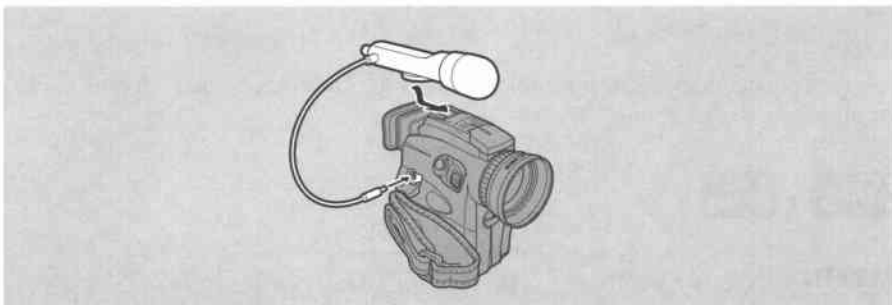
### To connect an external microphone:



 **Notes:**

- **When using an external microphone** → Connect it to the microphone terminal.
- **When using the DM-50 microphone** → Make sure nothing is connected to the microphone terminal.
- **When using the built-in microphone** → Make sure nothing is connected to either the microphone terminal or the accessory shoe.
- To use your TV to monitor video, connect the S-video terminal (  32) or the AV terminal (use only the video plug) to your TV. You can monitor the sound with headphones (  30).

## Preparations

Turn the camcorder's POWER switch to PLAY (VCR) and move the camcorder's TAPE/CARD switch to TAPE. Load a recorded cassette.

- Make sure the REC/SAVE tab on the cassette has been slid to REC (closed position).

## Dubbing

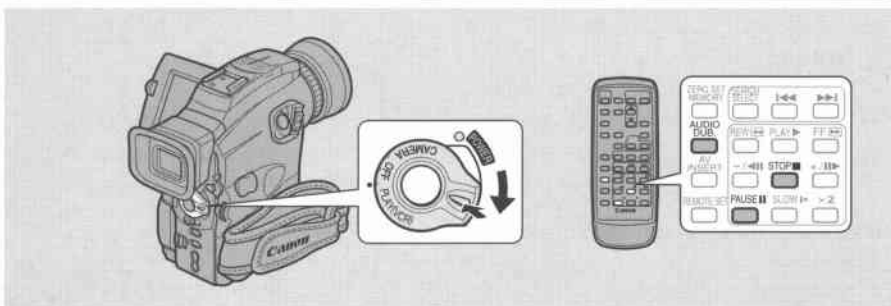

Do not connect/disconnect any cables to/from the camcorder when dubbing audio or preparing to dub audio.

**TAPE** + **PLAY (VCR)**

**MENU**





(  37)

▶ VCR SET UP

▶ AUDIO DUB...AUDIO IN

1. Open the menu and select VCR SET UP.
2. Select AUDIO DUB.
3. Select AUDIO IN or MIC. IN and close the menu.



4. **Locate the point where you want to start audio dubbing, then press the PAUSE button.**
  - You can use the playback buttons on the body of the camcorder or the special playback functions on the wireless controller in the same way as in playback mode.
  - The camcorder becomes set to playback pause mode.
5. **Press the AUDIO DUB. button.**
  - AUDIO DUB. and  appear on the display.
  - If you have the DM-50 microphone (optional) attached,  (Connection) appears in the display.
6. **Press the PAUSE button (and start play on the other audio device if AUDIO IN).**
  - Audio dubbing starts.
  - Direct your voice into the microphone.
  -  changes to .
7. **When you get to the point where you want to stop dubbing, press the STOP button (and then stop play on the other audio device if AUDIO IN).**
  - Audio dubbing stops and AUDIO DUB. disappears from the display.
  - The camcorder returns to stop mode.
  - You can also set zero set memory (  84) at the place you want to stop audio dubbing, then every time you return to that position, audio dubbing will cancel.
  - If instead of pressing STOP you press PAUSE, the camcorder will return to the playback pause mode.

**Notes:**

- You cannot use the DV terminal while adding sound.
- You might want to adjust the audio mix (  100) when playing back a tape with added sound.
- There may be a loss of sound quality if you add sound to a tape recorded on a camcorder other than the MVX1i.
- After adding sound 3 or more times to the same place on a tape, there may be some loss in sound quality.



E

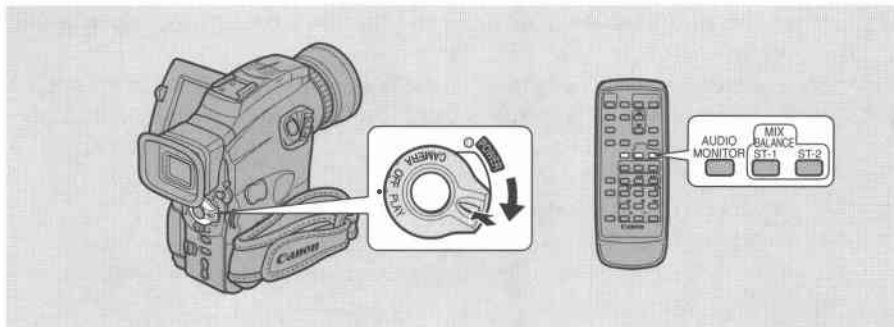

When you play back a tape that was recorded in 12-bit mode, you can set the audio output to play: stereo 1 (the original sound), stereo 2 (any new sound, dubbed to the tape after recording), or mix the balance between the two.

- Audio from the 16-bit mode only contains stereo 1 sound and so you cannot/ do not need to select the audio mix. The same is true for the 12-bit stereo 1 mode, unless new sound has been added post-recording.

TAPE + ( **PLAY** / PLAY(VCR) )

## 1. Choose the output.

- Press **AUDIO MONITOR** on the wireless controller.
- Starting with the last selected setting, 4 settings appear as you push the button:
  - STEREO1 for just stereo 1.
  - STEREO2 for just stereo 2.
  - MIX/FIXED for an equal mix of stereo 1 and 2.
  - MIX/VARI. (mix variable) for when you want to mix the balance between stereo 1 and 2.
- To simply choose STEREO1, STEREO2 or MIX/FIXED, make sure your choice appears on the display.
- If you choose MIX/VARI., you can go on to mix the balance.
- Use the ST-1/ST-2 keys to mix the balance. A bar showing the mix appears on the screen for 4 seconds.

### Note:

- When you have chosen the output, STEREO1, STEREO2, MIX/FIXED or MIX/VARI. is shown in the top left of the display for a few seconds. If you turn the power off the output is set to STEREO1.

## Selecting audio output channels

**E**

When you play back a tape whose audio has been recorded on multiple channels, you can change the output channels of that sound.

**TAPE** + (**PLAY**  
**PLAY/VCR**)

**MENU**  
( 37)

▶ VCR SET UP



▶ OUTPUT CH...L/R

1. Load a tape recorded with multiple-channel audio.
2. Open the menu and select **VCR SET UP**. Then select **OUTPUT CH**, set it to the desired setting and close the menu.
  - Refer to the following list.

OUTPUT CH setting	Played back sound	
	Tape recorded with stereo sound	Tape recorded on multiple channels
L/R	L+R channels	main + sub
L/L	L channel only	main only
R/R	R channel only	sub only

  
Editing

## Connecting to a PC

E

By using a DV cable and connecting the camcorder to a PC equipped with a DV terminal conforming to IEEE 1394/DV compatible capture board, you can transfer images taken with the camcorder to your PC.

- While connected, it is recommended that you power your camcorder from a household power socket using the power adapter.
- Turn off the power of both the camcorder and the PC before connecting.
- Optional software necessary.

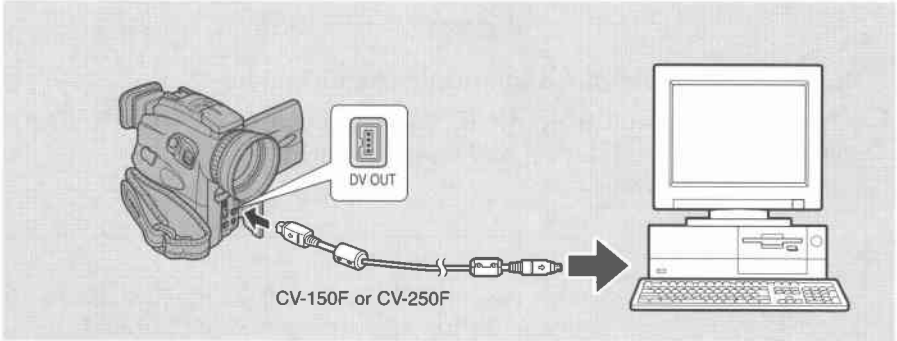

### Notes:

- Operation may not work correctly, depending on the software you are using, and the specifications of your PC and its settings.
- See your PC instruction manual for details.

## Memory Card Introduction

The camcorder can take, store and manage still images on 2 types of memory cards: the MultiMediaCard (supplied with the camcorder) or an SD Memory Card (commercially available). The MultiMediaCard is an ultra-small, ultra-light media that can record still images. About the same size as a MultiMediaCard, the SD (Secure Digital) Memory Card has the protect switch to protect your recording from accidental erasure, and fits into the same slot as the MultiMediaCard.

E

### You can do the following with a memory card:

- Record still images (☐ 107)
- View still images 3 ways: Single (☐ 111), Slide show (☐ 112), Index screen (☐ 112)
- Select the quality of images (☐ 104) and the image resolution (☐ 105) recorded on the card
- Protect important images against accidental erasure, print mark and erase still images (☐ 113-120)
- Create interesting effects by combining images (☐ 121)
- Record a still image from a cassette (☐ 109)
- Copy multiple still images automatically to and from a cassette (☐ 125, 126)

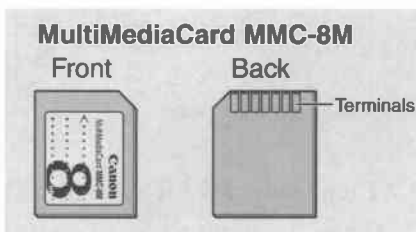

You can use most of the camcorder's functions when recording to a memory card, such as the various recording programs (☐ 56), self-timer (☐ 69), shutter speed (☐ 75), white balance (☐ 78) and other manual adjustments. Available functions are marked with a the **CARD + CAMERA** or **CARD + (PLAY/PLAY/VC)** icons.

- If you use memory cards other than the supplied one, make sure to format them with the camcorder.

### Important

- Inserting or removing the memory card without first setting the POWER switch to OFF can result in data damage.
- This camcorder uses only MultiMediaCards or SD Memory Cards (**SD**\*). You cannot use any other types of memory cards.

\* **SD** logo is a trademark.

## Inserting and removing the memory card

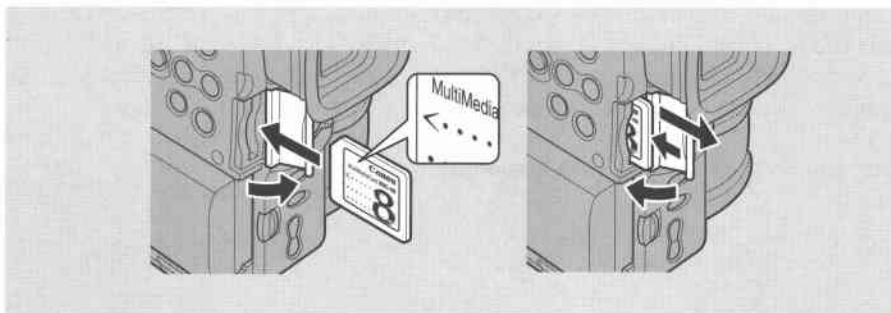

1. Turn the **POWER** switch to **OFF**.
2. Open the memory card compartment cover in the direction of the arrow.
3. **Insert or remove the memory card.**
  - Push the memory card all the way in.
  - Remove the memory card by pushing the card in and letting it spring out.

Do not attempt to pull the memory card out without first pushing it in.

4. **Close the cover.**



### Notes:

- When you set the camcorder to **CARD PLAY** (MVX1i: **CARD PLAY (VCR)**) mode, the last image recorded appears. If there are no images recorded on the memory card, **NO IMAGES** appears in the display.
- Do not touch the memory card terminals.

## Selecting the recording image quality



Select the quality of a still image to be recorded.

**TAPE** + ( **PLAY** / **PLAY(VCR)** ), **CARD** + **CAMERA**

**MENU**

( 37 )

▶ **CARD SET UP**

▶ **QUALITY...STANDARD**

To change the image quality, open the menu and select **CARD SET UP**. Then select **QUALITY**, set it to **FINE** and close the menu.

 **Notes:**

- Depending on the image you are recording, sometimes there will be no difference in image quality between settings.
- Images are compressed and recorded in the JPEG (Joint Photographic Experts Group) format.
- The number of images that can still be recorded on a memory card may sometimes decrease by 2 images at once.
- Refer to p. 154 for the memory card displays.

### Selecting the recording image resolution



Select the image resolution of a still image to be recorded.

CARD + CAMERA

**MENU**  
( 37)

▶ CARD SET UP

▶ IMAGE RES. •• 1280×960

**To change the image resolution to 640 × 480, open the menu and select CARD SET UP. Then select IMAGE RES., set it to 640 × 480 and close the menu.**

 **Notes:**

- The number of pixels is 640 × 480 and 1280 × 960 in both STANDARD and FINE.

	Image resolution	1280 × 960	640 × 480
Image quality			
Standard		Approx. 32 images	Approx. 106 images
Fine		Approx. 17 images	Approx. 61 images

- \* These figures are approximate, number of images per 8MB MMC. The actual number you will be able to record varies depending on the images. Remember that the sample images already recorded on the supplied MultiMediaCard are included in the total number.
- When still images are recorded at an image size of 1280 × 960 on your camcorder, images are sometimes not played back properly on other digital devices that do not support recording at an image size of 1280 × 960.

## File numbers



The images you take are automatically assigned file numbers from 0101-9900 and stored in folders of 100 images each. Each folder is numbered from 101 to 998 and recorded on the memory card. Sample images have been pre-recorded on the supplied MultiMediaCard, entering folder number 100 (folder name is "100canon").

Set the image file numbers so that they reset each time a new memory card is inserted, or so that they count up continuously.

### 1 CONTINUOUS

Numbering is continuous between cards, so that the first file number assigned on a new memory card is 1 more than the last file number assigned on the previous memory card. When the file numbers are set to CONTINUOUS, each image taken is assigned a different number, avoiding duplication of numbers. This is convenient when you want to manage your images on a PC. We recommend keeping the file numbers set to CONTINUOUS.

Three images are recorded on the card.

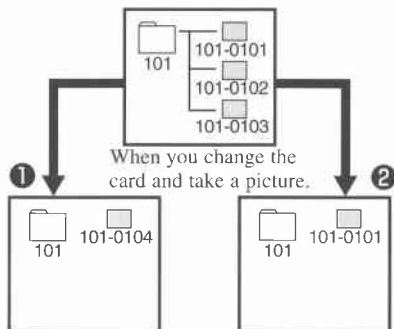

### 2 RESET

Each time you insert a new memory card, the file number resets to its default value (101-0101). If the card already contains files, the next available number is assigned.



### MENU

( 37)

▶CARD SET UP

▶FILE NOS...CONTINUOUS

To change the file numbering, open the menu and select **CARD SET UP**. Then select **FILE NOS.**, set it to **RESET** and close the menu.

## Turn off the shutter sound



Makes the sound of a shutter being released when a still image is recorded to a memory card.



### MENU

( 37)

▶CARD SET UP

▶SHTR SOUND...ON

To turn the shutter sound off, open the menu and select **CARD SET UP**. Then select **SHTR SOUND**, set it to **OFF** and close the menu.



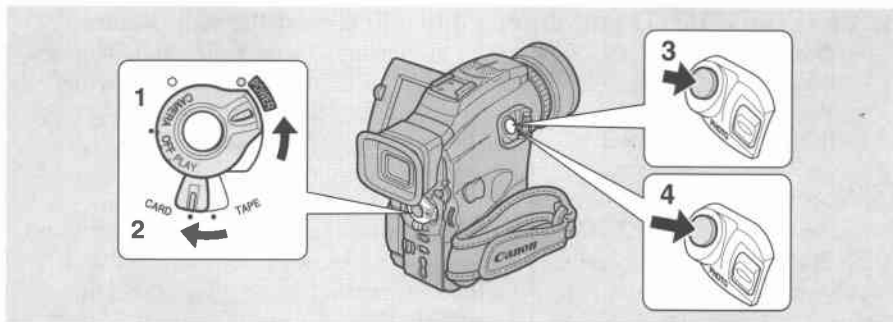

The camcorder is equipped with a mechanical shutter so that you can record vivid still images onto a memory card. (Progressive Photo function) You can also record onto a memory card images from a tape in the camcorder, or images input through the DV in terminal (MVX1i only).

- Moving pictures cannot be recorded onto a memory card.
- MVX1i only: Images input through the AV in terminal cannot be recorded onto a memory card.
- Memory cards cannot record audio.
- If you are using an SD Memory Card, make sure the protect switch is set to allow recording.
- To record still images using the built-in flash, refer to “Using the Built-in Flash” on p. 53.

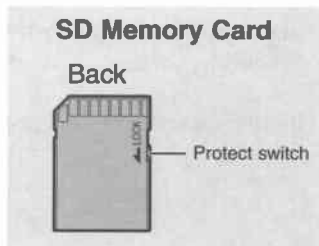

Make sure a memory card that has enough memory available is inserted into the camcorder.



While the card access indicator flashes, do not disconnect the power source. Doing so could result in data damage.

- 1. Press the small green button on the POWER switch and hold, turn the POWER switch to CAMERA.**
- 2. Move the TAPE/CARD switch to CARD.**
  - The number of images that can still be recorded on the memory card, and other information appear in the display.
  - The camcorder will turn itself off if you are using a battery and do not operate the camcorder for more than about 5 minutes. Set the POWER switch to OFF and then back to CAMERA.
- 3. Press the PHOTO button halfway and hold it.**
  - Exposure is locked.
  - During autofocus  flashes white in the display as the camcorder adjust the focus and it is displayed continuously as a green mark when the camcorder is ready to take the still image.

#### 4. Press the PHOTO button fully down to record the still picture.

- **●** disappears from the display. The shutter sound sounds and simultaneously the display appears to close for an instant as if it were a shutter releasing.
- While the camcorder is recording the still image, the card access indicator flashes and RECORDING TO CARD flashes in the display.

#### Notes:

- To use the self-timer ( 69), press the  button before step 3, and then press the PHOTO button fully down.
- The wireless controller's PHOTO button has no half-way setting. Press the button fully and the camcorder immediately takes the image.
- When the POWER switch is set to CAMERA and the TAPE/CARD switch is moved from TAPE to CARD, the camcorder modifies the image for appropriate recording onto a memory card.
- When the TAPE/CARD switch is operated with the POWER switch set to CAMERA, the subject size changes slightly.
- When the subject is too bright (overexposure) in CARD CAMERA mode, OVEREXP. will flash in the display. We recommend that you use the ND filter supplied with the optional FS-43U Filter Set. (However, you can continue recording.) When exposure is locked, OVEREXP. does not appear.

#### The indicators that appear in the display when recording to a memory card:

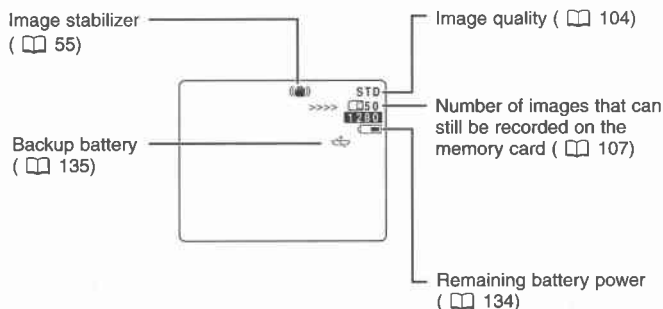

## Recording an Image from a Cassette as a Still Image

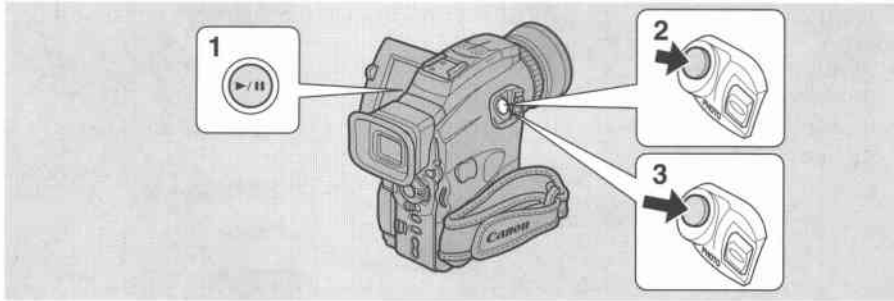

E

Record an image from a cassette onto a memory card. To automatically record multiple still images from a cassette to a memory card, refer to “Copying Still Images from a Cassette” on p. 125.

- A still image recorded to a tape is recorded at an image size of  $768 \times 576$  onto a memory card.
- The still image’s data code will reflect the date and time it is recorded to the memory card.

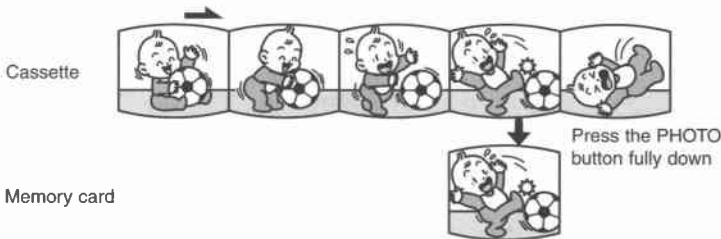

TAPE + (PLAY / PLAY(VCR))

1. **Play back the cassette.**
2. **When the image you want to record appears in the display, press the PHOTO button halfway down and hold it.**
  - The tape is set to playback pause mode and the number of images that can still be recorded on the memory card appears in the display.
3. **Press the PHOTO button fully down to record the image to the memory card.**
  - The card access indicator flashes.

### Notes:

- You can also set the cassette to playback pause mode in step 1 and record the image with only 1 full press of PHOTO button.
- If you record an image onto a memory card that was originally recorded in the 16:9 mode for wide screen TV’s, the image will appear to be vertically “squashed” (compressed).
- The shutter sound doesn’t sound in TAPE PLAY (MVX1i: TAPE PLAY(VCR) mode.

## Recording from Another DV Device as a Still Image (MVX1i only)

E

Record images input through the DV in terminal onto the memory card as still images.

- A still image input through the DV in terminal is recorded at an image size of  $768 \times 576$  onto a memory card.
- The still image's data code will reflect the date and time it is recorded to the memory card.

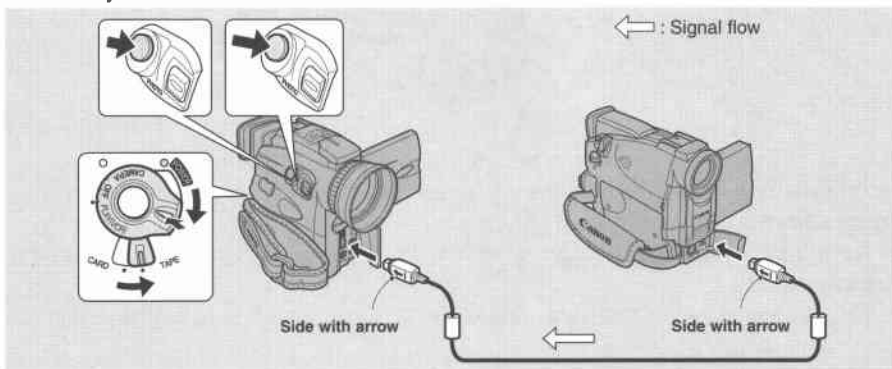

### Preparations

1. **Connect the camcorder to the other digital device.**
  - Connect the Canon CV-150F DV cable (optional) with the sides of the plugs marked with the arrows facing as shown above.
2. **Prepare the other device.**
  - Turn on the power and load a recorded cassette.
3. **Load a memory card. Turn the camcorder's POWER switch to PLAY(VCR).**
4. **Move the TAPE/CARD switch to TAPE.**
  - DV IN appears in the display.
  - If you have a cassette inserted, make sure it is in stop mode.

### Recording



1. **Start playback on the other device.**
2. **When the image you want to record appears in the display, press the PHOTO button halfway down and hold it.**
  - The image appears as a still image in the display.
  - The number of images that can still be recorded on the memory card appears in the display.
3. **Press the PHOTO button fully down to record the image to the memory card.**
  - The card access indicator flashes.

#### Notes:

- If you record an image onto a memory card that was originally recorded in the 16:9 mode for wide screen TV's, the image will appear to be vertically "squashed" (compressed).
- The shutter sound doesn't sound in TAPE PLAY(VCR) mode.

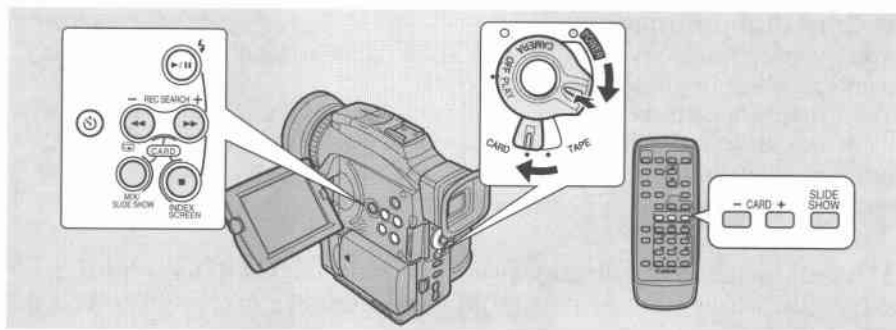

Play back and view still images recorded on a memory card. (For details on connecting to a TV, see “Connections for Playback on a TV Screen” on p. 31)

- The camcorder may not be able to copy or play, etc., images recorded on a non-Canon camcorder.
- When viewing on the LCD screen or TV screen still images that you recorded to a memory card with this camcorder, the images appear with black frame in the display.

### Do not change the data recorded on a memory card.

- You may not be able to play back the following still images correctly on this camcorder:
  - Still images that have not been recorded with this camcorder but downloaded from a PC (excluding the sample images on p. 129-130)
  - Still images that have been recorded with this camcorder but have subsequently been enhanced on a PC
  - Still images whose image file names have been changed on a PC

### There are 3 ways to view still images:

- Single image
- Slide show: One after the other automatically in order of recording
- Index screen: Six images at once

When the camcorder is in playback pause mode, you can use card jump function to move quickly through still images recorded anywhere on a memory card to find a still image you want to view (Card Jump function).

Make sure a memory card that has images recorded on it is inserted into the camcorder.

While the card access indicator flashes, do not disconnect the power source. Doing so could result in data damage.

### ● Single Image

1. Turn the POWER switch to PLAY (MVX1i: PLAY(VCR)).
2. Move the TAPE/CARD switch to CARD.
  - The last image recorded appears in the display.
3. Search for the desired still image by pressing the CARD +/- buttons.
  - Press + to view the next image and – to view the previous image.
  - Pressing + at the last image will take you to the first image. Pressing – at the first image will take you to the last image.

## ● Card Jump Function

You can jump from the current image to the desired image of unadjacent image number without displaying the images one by one. The numbers shown in the upper right in CARD PLAY (MVX1i: CARD PLAY(VCR)) mode indicate the image number of the current still image / total number of still images on the memory card.



**With an image in the display, press and hold the CARD +/- button.**

- Press the + button to jump through the images forwards and press the - button to jump backwards.
- The image number moves forwards or backwards.
- When you release the button, the still image, to which the currently shown number is assigned, appears in the display.

## ● Slide Show



**With an image in the display, press the SLIDE SHOW button.**

- The images are played back one after another.

**To stop the slide show, press the SLIDE SHOW button.**

- The slide show starts or stops each time you press the SLIDE SHOW button.

## ● Index Screen

Up to 6 images appear at once so you can search quickly for an image.



1. **With an image in the display, press the INDEX SCREEN button.**
  - Up to 6 images appear in the display.
2. **Move the  mark to the image you want to view.**
  - Turn the selector dial downwards to go to the previous image and upwards to go to the next image.
  - Turning the dial upwards at the last image will take you to the next index screen. Turning the dial downwards at the first image will take you to the previous index screen.
  - Jump to the next/previous index screen with the CARD +/- buttons.
3. **Press the INDEX SCREEN button.**
  - The image you have marked fills the whole display.

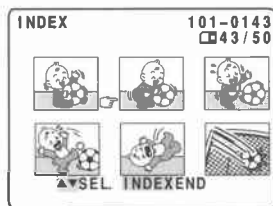

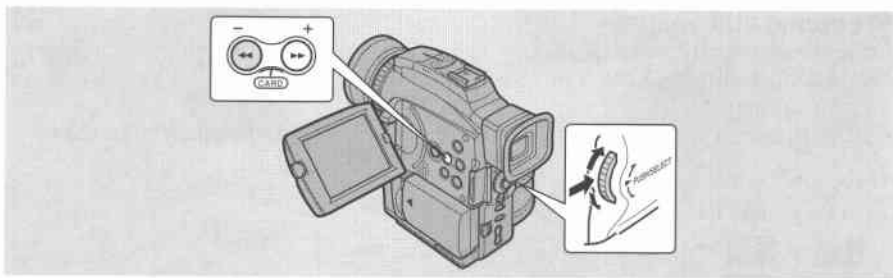

Immediately after you have recorded a still image to a memory card, you can check the image without switching the operation mode by the POWER switch. (CARD PHOTO REVIEW)

You can also easily erase unwanted images while viewing still images recorded to memory card, protect images from accidental erasure, or mark an image for printing. (File Operation)

- Card Photo Review is set in CARD CAMERA mode and File Operation is set in CARD PLAY(MVX1i: CARD PLAY(VCR)) mode.

### ● Preventing accidental erasure (Protect )

Select important images and protect them from accidental erasure.

- If a memory card is formatted, however, all images, including protected images, will be permanently erased.
- The pre-recorded sample images provided on the supplied MultiMediaCard are already protected.

There are 3 ways to protect a still image (including the ways to cancel the setting).











1.  +  → CARD PHOTO REVIEW menu ( 114)
2.  + ( / ) → File Operation menu  ( 115)
3.  + ( / ) → Card Operations submenu  ( 116)

### ● Marking a still image for printing (Print Mark )

An image on a memory card must be marked before it can be printed. The camcorder supports the  DPOF (Digital Print Order Format) print format. Images can be automatically printed on a DPOF-supporting Canon Printer. Up to 50 images per memory card can be print marked.

There are 3 ways to mark a still image for printing (including the ways to cancel the setting).

**To mark an image for printing or erase print marks one at a time**

1.  + ( / ) → File Operation menu  ( 115)
2.  + ( / ) → Card Operations submenu  ( 117)

**To erase all print marks**

3.  + ( / ) → Card Operations submenu  ( 118)

## ● Erasing still images

Erase images singly or all at once.

- You cannot erase protected images. Cancel image protection first in order to erase an image.
- Erase images with caution. Once an image has been erased, it cannot be restored.

There are 3 ways to erase a single image.

**To erase images one at a time**

1. **CARD** + **CAMERA** → CARD PHOTO REVIEW menu (  114)
2. **CARD** + (  ) → File Operation menu **SINGLE** (  115)

**To erase images one at a time or erase all images on the memory card at once**

3. **CARD** + (  ) → Card Operations submenu **SINGLE** (  119)

**SINGLE**: When playing back an image in CARD PLAY (MVX1i: CARD PLAY(VCR)) mode



**INDEX**: When displaying an index screen in CARD PLAY (MVX1i: CARD PLAY(VCR)) mode

## CARD PHOTO REVIEW

**CARD** + **CAMERA**

1. **During/after recoding a still image, press the CARD – button to open the CARD PHOTO REVIEW menu.**
  - If you press the button after recording a still image, the last image recorded appears in the display.
  - If you press the button while recording a still image, the menu appears immediately.
  - **PROTECT** , **IMAGE ERASE** settings appear.
  - If you select **←RETURN**, the still image disappears.

To protect an image

2. **Select PROTECT  and press the selector dial in.**
  - The  protect mark appears on the image.
  - Now you are unable to erase this image.
  - Press the selector dial again to cancel it.
  - If you select **←RETURN**, the still image disappears.

To erase an image



2. **Select IMAGE ERASE and press the selector dial in.**
  - **ERASE THIS IMAGE? NO YES** appears in the display.
3. **Select YES and press the selector dial in.**
  - The image is erased.







## File Operation (FILE OPER.)

E





CARD + (PLAY/PLAY/VCRI)

1. **With an image in the display, press the selector dial in to open the FILE OPER. menu.**
  - PROTECT , PRINT MARK , and IMAGE ERASE settings appear.
  - If you select , the menu disappears from the display.

To protect an image

2. **Select PROTECT  and press the selector dial in.**
  - The  protect mark appears on the image.
  - Now you are unable to erase this image.
  - Press the selector dial again to cancel it.
  - If you select , the menu disappears from the display.
  - To cancel image protection, select PROTECT  and press the selector dial in.  disappears and now you can erase this image.

To mark an image for Printing (Print Mark)

2. **Select PRINT MARK  and press the selector dial in.**
  - The  print mark appears on the image.
  - Press the selector dial again to cancel it.
  - If you select , the menu disappears from the display.
  - To cancel a print mark, select PRINT MARK  and press the selector dial in.  disappears.

To erase the image

2. **Select IMAGE ERASE and press the selector dial in.**
  - ERASE THIS IMAGE? NO YES appears in the display.
  - If you select , the menu disappears from the display.
3. **Select YES and press the selector dial in.**
  - The image is erased.
  - One image before the erased image appears.



E

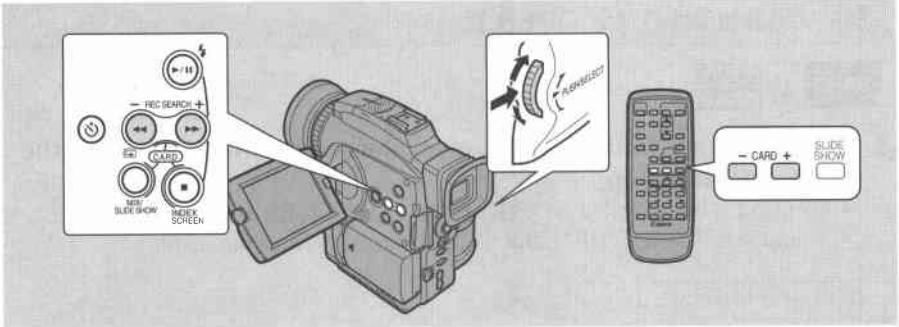

This section describes how to protect the still image from the Card Operation submenu when displaying an index screen in CARD PLAY (MVX1i: CARD PLAY(VCR)) mode (including the way to cancel the setting). You can also protect a still image through CARD PHOTO REVIEW ( 114) or File Operation menu ( 115).

## Protecting an image while viewing an index screen

**CARD** + **PLAY**  
(PLAY(VCR))



Make sure a memory card that has images recorded on it is inserted into the camcorder.

Using a Memory Card

1. **With an image in the display, press the INDEX SCREEN button.**
  - Up to 6 images appear in the display.
  - Move the mark to the image that you want to protect (Index Screen 112)
2. **Open the menu and select CARD OPER.**
3. **Select  $\Rightarrow$ PROTECT .**
4. **Press the selector dial in.**
  - The protect mark appears on the image.
  - Now you are unable to erase this image.
  - Press the selector dial again to cancel it.
5. **Close the menu.**

**Note:**

- To cancel image protection, move the mark to the protected image and press the selector dial in. The protect mark disappears.

## Marking a Still Image for Printing (Print Mark)



E

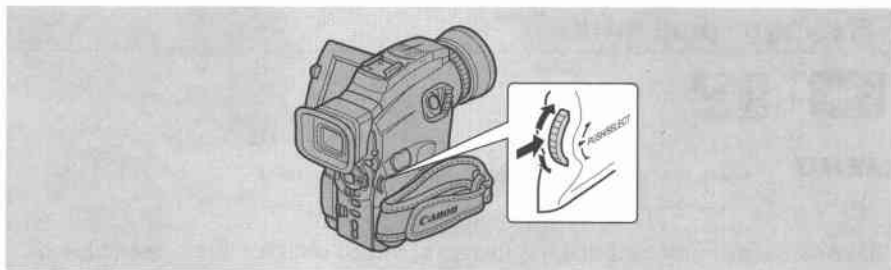

This section describes how to mark the still image for printing from Card operation submenu in CARD PLAY (MVX1i: CARD PLAY(VCR)) mode (including the way to cancel the setting).

- When displaying an index screen, you can mark the image for printing.
- When playing back a single image, you can erase all print marks.

You can also mark a still image for printing through File Operation menu (☐ 115).

### Marking an image for printing while viewing an index screen



Make sure a memory card that has images recorded on it has been inserted into the camcorder.

- 1. With an image in the display, press the INDEX SCREEN button.**
  - Up to 6 images appear in the display.
  - Move the mark to the image that you want to mark an image for printing (Index Screen ☐ 112).
- 2. Open the menu and select CARD OPER.**
- 3. Select PRINT MARK .**
- 4. Press the selector dial in.**
  - The print mark appears next to the image.
  - Press the selector dial again to cancel it.
- 5. Close the menu.**

#### Notes:

- To cancel a print mark, move to the print-marked image and press the selector dial in. The print mark disappears.
- If there are a large number of images recorded on the memory card, it may take time for a print mark to appear on an image.

## Erasing all print marks

**CARD** + (**PLAY**  
PLAY/VCR)

**MENU**

( 37)

▶ CARD OPER.

▶ PRINT MARKS ▶ ALL ERASE

Make sure a memory card that has images recorded on it has been inserted into the camcorder.

1. **With an image in the display, open the menu and select CARD OPER.**
2. **Select PRINT MARKS ▶ ALL ERASE.**
  - ERASE ALL PRINT MARKS ▶ ? YES NO appears in the display.
3. **Select YES.**
  - The ▶ print mark disappears from the image.
4. **Close the menu.**

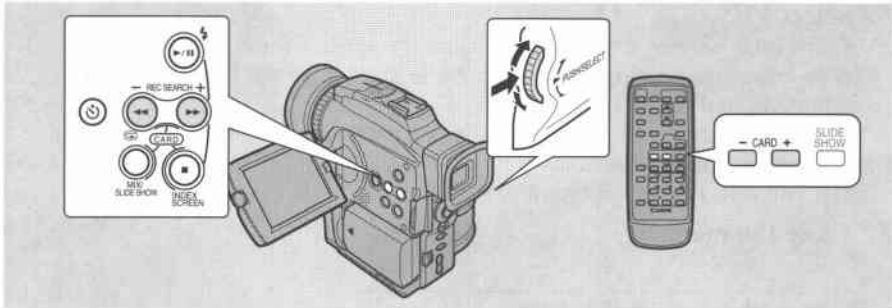

This section describes how to erase the still image from the Card Operation submenu when playing back a single image in CARD PLAY (MVX1i: CARD PLAY(VCR)) mode. (SINGLE or ALL)

You can also erase a still image through CARD PHOTO REVIEW (☐ 114) or File Operation menu (☐ 115).

**CARD** + **PLAY**  
(PLAY(VCR))

**MENU**  
(☐ 37)

▶CARD OPER.

▶IMAGE ERASE

Make sure a memory card that has images recorded on it is inserted into the camcorder.

To erase images one at a time

**1. Select the image you want to erase.**

- Use the index screen (☐ 112) or card jump function (☐ 112) if necessary and make sure the image you want to erase fills the display.
- If you use the index screen, press the INDEX SCREEN button after selecting the image. The image you selected fills the whole display.

**2. Open the menu and select CARD OPER.**

**3. Select IMAGE ERASE.**

- CANCEL, SINGLE and ALL settings appear.
- To cancel erasing, select CANCEL and close the menu.

**4. Select SINGLE.**

- ERASE THIS IMAGE? NO YES appears in the display.

**5. Select YES.**

- The image erases and the previous image appears for erasing.
- To erase another single image, move to that image with the CARD +/- buttons, and select YES.
- If the image you are trying to erase is a protected image, YES appears in purple and is unselectable.
- If you select NO, you return to step 4.

**6. Close the menu.**

To erase all images on the memory card at once

**1. Open the menu and select CARD OPER.****2. Select IMAGE ERASE.**

- CANCEL, SINGLE and ALL settings appear.
- To cancel erasing, select CANCEL and close the menu.

**3. Select ALL.**

- ERASE ALL IMAGES? [EXCEPT FOR  IMAGES] NO YES appears in the display.

**4. Select YES.**

- All images except the protected ones are erased.
- If you select NO, you return to step 2.

**5. Close the menu.**



Liven up your productions by superimposing one image on top of the other. Combine 2 still images or a still image and a moving image. Choose a still image from the memory card, either one of the pre-recorded sample images (  129) or one you have recorded yourself, then combine it with the currently recording image, moving or still.

## Select from 2 types of Title Mix effects:

### CHROMA (Chroma key)

The currently recording image appears in place of the blue area of a pre-recorded sample image such as a picture frame. When overlapping a title in the image, make sure to write it on a blue background and zoom in until it fills the display, then to record it to memory card. Adjust the mix level in the blue area of the pre-recorded image.

Image being recorded  
by the camcorder



Still image

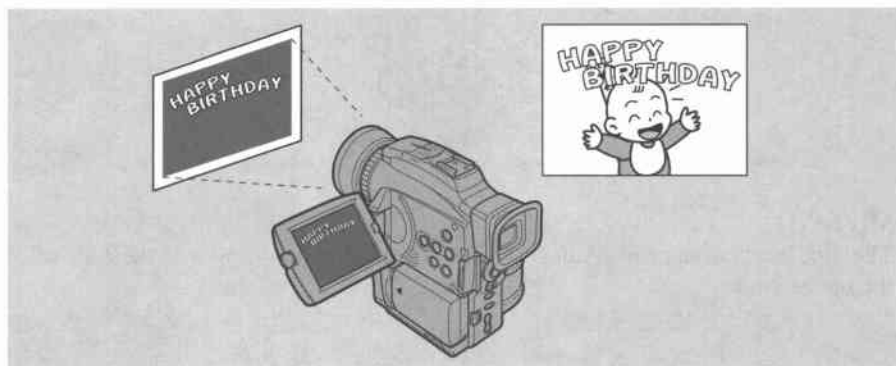

## LUMI. (Luminance key)

The currently recording image appears in place of the light area of a pre-recorded sample image such as a picture frame. When overlapping a title in the image, make sure to write it on a white background and zoom in until it fills the display, then to record it to memory card. Adjust the mix level in the light area of the pre-recorded image.

Image being recorded  
by the camcorder



Still image

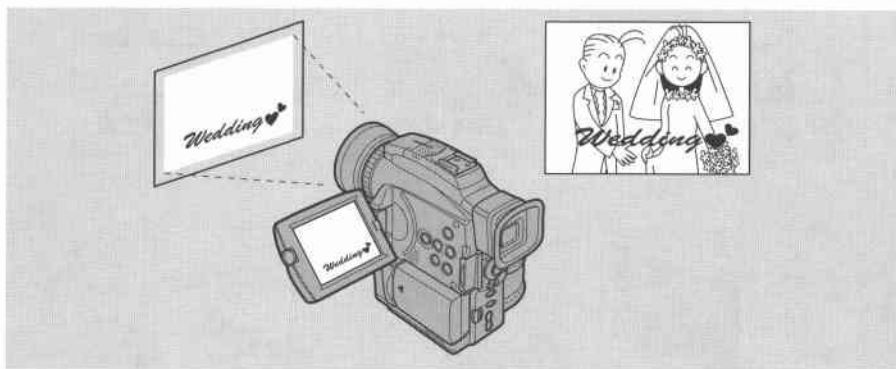
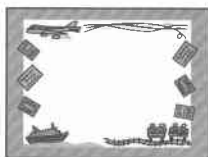

## Mix level

The mix level bar appears. Adjust the mix level using the - and + at the ends of the bar as guides.

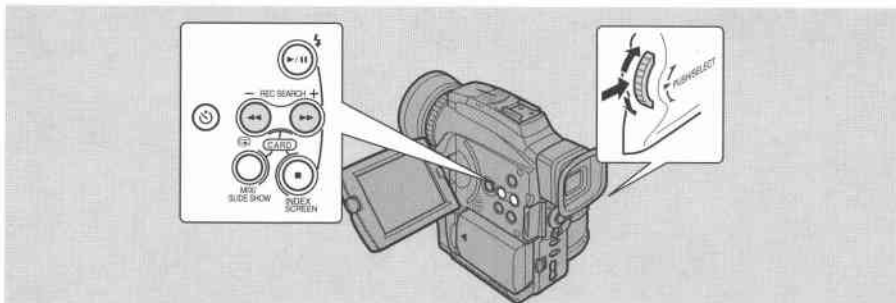



TAPE + CAMERA

E

**MENU**  
( 37)

▶▶TITLE MIX

▶▶MIX TYPE...CHROMA

▶▶MIX LEVEL...

Make sure a memory card that has images recorded on it and a cassette have been inserted into the camcorder.

Make sure the program selector is set to **P**.

Select

1. **Open the menu and select** ▶▶TITLE MIX.
2. **Press the CARD +/- buttons to select the still image to be combined.**
3. **Select MIX TYPE.**
  - CHROMA, LUMI. settings appear.
4. **Select the desired setting.**
  - Your currently recording image is combined with the pre-recorded still image.
5. **Select MIX LEVEL.**
6. **Adjust the mix level.**
  - Turning the selector dial upwards adjusts to the right and turning downwards adjusts to the left.
7. **Close the menu.**
  - TITLE MIX flashes in the display.

On/Off

8. **Press the MIX button.**
  - TITLE MIX stops flashing.
  - Your currently recording image is combined with the pre-recorded still image.
  - Each time you press the MIX button, your selection is activated (display lights continuously) or deactivated (display flashes).

For movies



1. **Press the start/stop button to start and stop recording.**
  - The combined images are recorded onto the cassette.

For stills

**1. Press the PHOTO button halfway down and hold it.**

- ● flashes white in the display as the camcorder adjusts the focus and it is displayed continuously as a green mark when the camcorder is ready to take the image.

**2. Press the PHOTO button fully down to record the image to the cassette.**

- ● disappears from the display.
- The combined images are recorded onto the cassette for approximately 6 seconds (8 seconds in the  SP or  LP recording mode).



**Notes:**

- If you change the position of the POWER switch, select your still image for Title Mix again.
- When setting Title Mix, you must carry out steps 1 to 4.

## Copying Still Images from a Cassette

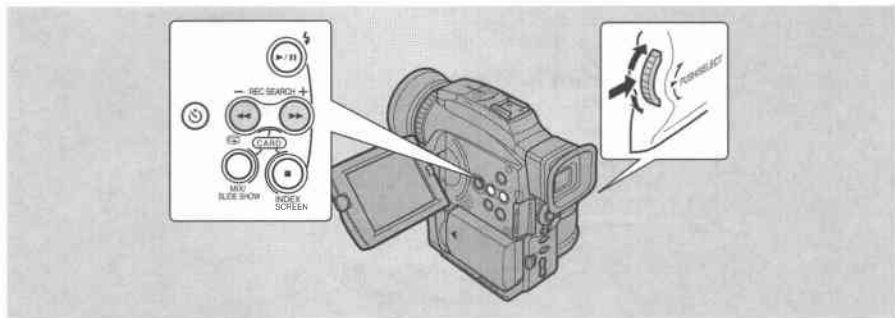

E

Copies multiple still images from a tape to the memory card, using the Photo Search function.

- A still image recorded to a tape is recorded onto a memory card at an image size of  $768 \times 576$ .
- The still images' data codes will reflect the date and time the copies are made.

TAPE + (PLAY/PLAY(VCR))

**MENU**

( [ ] 37)



Make sure a memory card that has enough memory available and a recorded cassette have been inserted into the camcorder.

1. **Locate the first still image on the cassette that you want to copy and stop the cassette at a point before that image.**
  - All the still images on the cassette after that point will be copied onto the memory card.
  - If you want to copy all the images on a cassette, rewind the cassette to the beginning.
2. **Open the menu and select CARD OPER.**
3. **Select COPY [ ] [ ] .**
  - CANCEL and EXECUTE settings appear.
4. **Select EXECUTE.**
  - Select CANCEL to stop copying.
  - Cassette and card information appear in the display and copying starts.
  - NOW COPYING [ ] [ ] appears in the display.
  - The camcorder automatically performs the Photo Search function to locate still images and copying starts. The currently copying image appears in the display.
  - Copying stops when the cassette is finished or the memory card is full. When the memory card is full, CARD FULL will appear in the display.
5. **Press the stop button when your desired images have finished copying.**



E

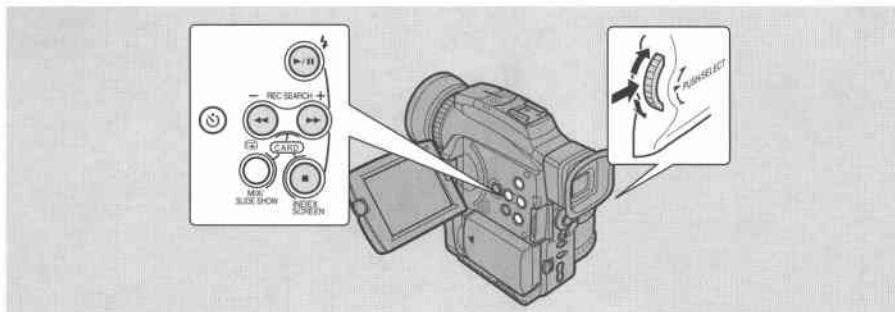

Copies multiple still images from the memory card to a cassette.

- The still images' data codes will reflect the date and time the copies are made.
- The **SP** and **LP** recording modes are not available when copying memory card images to a cassette.

## MENU

( 37)



Make sure a memory card that has images recorded on it and a cassette that has enough recordable space have been inserted into the camcorder.

**TAPE** + **PLAY**  
(PLAY/VCRI)

1. Locate the point on the cassette where you want to start copying and set it to stop.

**CARD** + **PLAY**  
(PLAY/VCRI)

2. Select the first image you want to copy by using the **CARD +/-** buttons.
  - Still images on the memory card including and after that image will be copied onto the cassette.
  - If you want to copy all the still images on the memory card, select the first image.
3. Open the menu and select **CARD OPER.**
4. Select **COPY [ ]**.
  - **CANCEL** and **EXECUTE** settings appear.
5. Select **EXECUTE**.
  - Select **CANCEL** to stop copying.
  - Cassette and card information appear in the display and copying starts.
  - **NOW COPYING [ ]** appears in the display.
  - Each image is copied for about 6 seconds on the cassette.
  - Copying stops when all the images have been copied or the tape is full.
6. Press the **■** button when your desired images have finished copying.

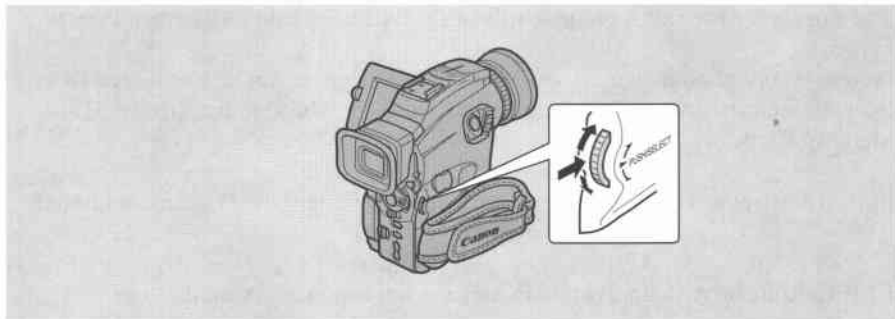

Format new memory cards, if you get the message **CARD ERROR**, or to permanently and quickly erase all the images on a memory card, including protected images (this includes the pre-recorded card mix sample images). The MultiMediaCard supplied with this camcorder has already been formatted for you.

- Be cautious when formatting recorded memory cards. All images will be permanently erased.
- If you use memory cards other than the supplied one, make sure to format them with the camcorder, not a PC or other device.

**CARD** + ( **PLAY**  
PLAY/VCRI )

## **MENU**

( 37 )



Make sure a memory card is inserted into the camcorder.

- 1. Open the menu and select CARD OPER.**
- 2. Select FORMAT.**
  - CANCEL and EXECUTE settings appear.
- 3. Select EXECUTE.**
  - Select CANCEL to cancel formatting.
  - **FORMAT THIS CARD? NO YES** appears to confirm.
- 4. Select YES.**
  - Formatting starts and **NOW FORMATTING** appears in the display.
  - If you select NO, you return to step 3.
- 5. Close the menu.**

## Other Information and Precautions

E

The camcorder formats memory cards in DCF (Design rule for Camera File system).

Images recorded on a memory card with this camcorder can be transferred to a PC with the use of the following products made for MultiMediaCards or SD Memory Cards:

**PC Card Adapter:** Holds a memory card then inserts into the PC card slot found on most types of laptop PCs.

**USB Card Reader:** Connects to a PC, then accepts a memory card.

**FD Adapter:** Holds a MultiMediaCard then inserts into a PC's floppy disk drive.

### Memory Cards confirmed to operate with this camcorder (as of June 2001)

MultiMediaCard—

SanDisk: 8 MB, 16 MB, 32 MB, 64 MB

SD Memory Card—

Panasonic: 32 MB, 64 MB

- However, we cannot guarantee that all of these memory cards work properly.

If you mistakenly erase the card mix sample images provided on the MultiMediaCard, they can be downloaded from the following home pages:\*

<http://www.canon-europa.com/products/products.html>

<http://www.canon-asia.com/>

<http://www.canon.com.au>

\*You will need a PC Card Adapter or USB Card Reader to be able to download to a memory card.

### Memory card operating precautions

- If you purchase additional memory cards, format them with the camcorder, not a PC or other device. There have been cases where memory cards formatted with a PC or other device do not function properly.
- We recommend saving backups of memory card images on your PC's hard drive or other external memory device. Image data may be damaged or lost due to a defect in a memory card, or if a memory card is exposed to static electricity. Contents of a memory card cannot be compensated for should data become damaged or lost.
- Do not remove the power source or the memory card while the card access indicator flashes.
- Do not use memory cards in places subject to strong magnetic fields.
- Do not disassemble memory cards.

- Do not bend or drop memory cards, or expose them to strong vibrations or external shocks.
- Do not get memory cards wet.
- Do not remove the memory card's label or affix other labels. Affix labels to the memory card's case.
- Do not leave memory cards in places subject to high temperature or high humidity.
- Moving a memory card rapidly between hot and cold temperatures may cause condensation to form on it, leading to malfunctions. Avoid this problem by placing the memory card in a plastic bag and letting it slowly adjust to temperature changes before removing it from the bag. If condensation should occur, maintain the memory card at a constant temperature and let the moisture evaporate naturally.
- Do not touch the memory card's terminals or let dust or dirt come in contact with the terminals. Store and carry memory cards in their case to protect the terminal area.
- There is only one correct way to insert memory cards into the camcorder. Do not forcefully insert the memory cards backwards or upside down. This could damage the memory card or the camcorder.

### Sample images

- The following are the sample images that have been pre-recorded on the included MultiMediaCard. There are a total of 13 images: 8 Chroma key images and 5 Luminance key images.

#### Chroma key

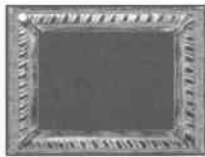
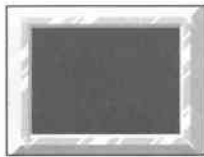
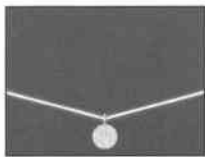
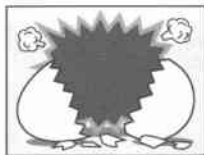

## Luminance key

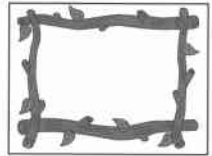
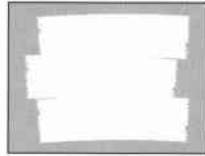
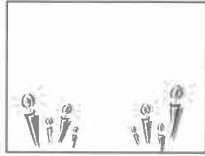

- The pre-recorded sample images on the MultiMediaCard included with this camcorder are intended solely for the personal enjoyment gained from combining them with personal videos taken with this camcorder. Do not use the pre-recorded sample images for any other purpose.

### MultiMediaCard MMC-8M Specifications

<b>Capacity</b>	8 MB
<b>Interface</b>	MultiMediaCard standard
<b>Operating temperature range</b>	0°C–40°C (32°F–140°F)
<b>Dimensions</b>	32 × 24 × 1.4 mm
<b>Weight</b>	1.5 g

Weight and dimensions are approximate.  
 Errors and omissions excepted.  
 Subject to change without notice.

PhotoEssentials - Royalty Free Stock Photography

The PhotoEssentials suite of royalty-free images on CD-ROM features premium quality assignment photography and is ideally suited for use in advertising, brochures, reports, multimedia, websites, books, packaging and more.

For more information, please visit their website [www.photoessentials.com](http://www.photoessentials.com)



## Preparing the Camcorder

**E**

### Adjust the viewfinder

- Set the camcorder to TAPE CAMERA mode. Extend the viewfinder straight out and rotate it upwards, then adjust the viewfinder focusing lever to suit your eyesight.
- Rotate the viewfinder to an angle that allows you to view comfortably. Store the camcorder with the viewfinder flush with the body of the camcorder.
- To view with the viewfinder, make sure the LCD panel is either turned so that the subject can monitor viewing, or totally closed with the screen facing inwards.

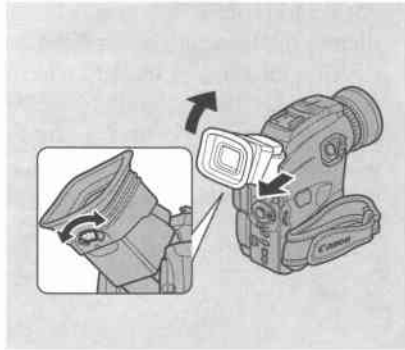

- Be careful not to leave the viewfinder exposed to bright sunlight, or it will melt. (The light is concentrated by the viewfinder lens.) Adjust the angle of the viewfinder to prevent sunlight from entering.

### Attaching the Lens Hood

Since the lens hood cuts stray light that may cause flare and ghost images and protects the lens, be sure to attach the hood when you are recording.

1. **Align the hood to the lens with the Canon logo facing to the left.**
2. **Twist it into position (clockwise), so that the Canon logo is to the top.**
  - Make sure attach the hood to the camcorder horizontally.



### Prepare the lens cap

- Attach the cord to the grip belt, and then to the lens cap, passing the cord through the hole in the lens cap from front side.
- Hook the lens cap on to the grip belt while you are recording, and place it over the lens when you have finished.

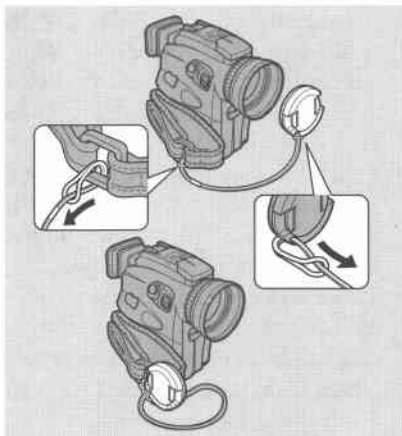

### Fasten the grip belt

- Rotate the viewfinder downwards.
- Release the Velcro fastening and hold the camcorder with your right hand while you adjust the belt with your left. Your index finger should reach the zoom control and photo button, and your thumb should reach the start/stop button comfortably.

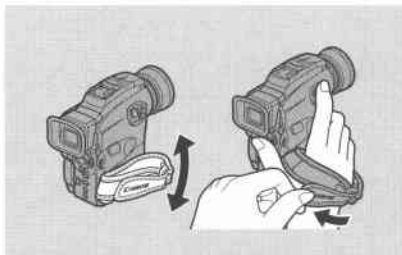

## Notes on Using the Batteries

**E**

### Charging and recording times

- These times vary — the safest policy is always to have 2 or 3 times as many battery packs as you think you will need.
- You will get more recording time if you turn the camcorder off between shots, instead of leaving it in record pause mode.

	Time needed for full recharge	Maximum recording time	
		Using viewfinder	Using LCD screen
BP-512	1 hr. 10 min.	2 hr.	1 hr. 40 min.
BP-511 (optional)	1 hr. 10 min.	2 hr.	1 hr. 40 min.
BP-522 (optional)	2 hr.	4 hr.	3 hr. 30 min.
BP-535 (optional)	2 hr. 50 min.	6 hr. 30 min.	5 hr. 40 min.

- Recording time will be shorter than usual at low temperatures. You can use the battery pack between 0° to 40°C (32° and 104°F), but it works best between 10° to 30°C (50° and 86°F).
- If the battery pack starts to give you much less operating time than usual (at normal temperatures), it has reached the end of its life and must be replaced.



#### Note:

- These figures show how long you can view playback with the LCD, after attaching a fully-charged battery pack. Playback time will be shortened at low temperatures.

	Playback time (using the LCD screen)
BP-512	2 hr. 10 min.
BP-511 (optional)	2 hr. 10 min.
BP-522 (optional)	4 hr. 35 min.
BP-535 (optional)	7 hr. 15 min.

## How much power is left?

The indicator in the display shows you approximately how much charge the battery pack has left:

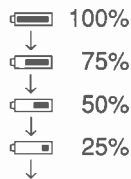

### Notes:

- When the power is completely exhausted, “CHANGE THE BATTERY PACK” appears in the display for 4 seconds and the empty battery mark starts to flash. The power indicator light also flashes.
- The indicator is not constant — different levels will be shown when you subject the battery pack and camcorder to different conditions.

## When to recharge

You can recharge a lithium ion battery pack whenever it is convenient. Unlike a conventional battery pack, it does not have to be fully discharged first. However, as the battery pack will naturally discharge itself over time, it is best to charge it the same day you plan to use it, or the day before.

## Taking care of the battery pack

### Always attach the terminal cover.

- Do not allow any metal objects to touch the terminals, as this can cause a short circuit and damage the battery pack. Attach the terminal cover whenever the battery pack is not being used.

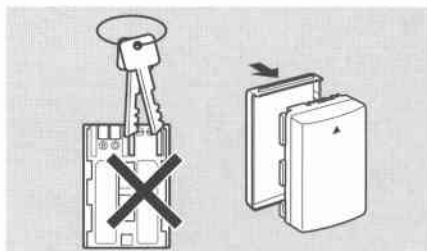

### Keep the terminals clean.

- The camcorder, adapter or battery pack will not work properly if the terminals are dirty. Attach the terminal cover whenever the battery pack is not being used.

### Storing the battery pack.

- If you do not use a battery pack for a period of more than a few months any remaining charge may cause damage to the battery pack, and reduce usage time. To prevent damage therefore, aim to use a battery pack's complete charge before storage. See the optional battery pack's instructions for further details.

## Installing the backup battery

Pull out the backup battery holder from the base of the camcorder, and insert the CR1616 lithium battery with the + side facing outwards. Click the holder back into place.

This backup battery allows the camcorder to remember the date and time and other settings when main power source is removed. It has a life span of about a year.

When it needs replacing (or if it has not been installed), the  mark flashes in the display.

Make sure to attach a power source to the camcorder first, so it will remember your chosen settings when you change the battery.

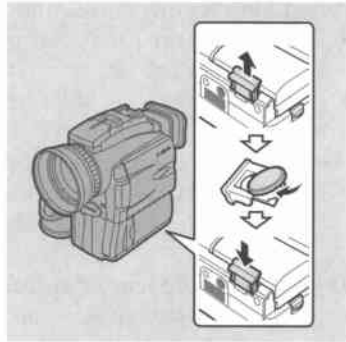

### **DANGER!**

#### **Treat the battery pack with care.**

- Keep it away from fire (or it might explode).
- Do not expose the battery pack to temperatures greater than 60°C (140°F). Do not leave it near a heater, or inside a car in hot weather, for example.
- Do not try to disassemble or modify it.
- Do not drop or knock it.
- Do not get it wet.

### **WARNING!**

- The battery used in this device may present a fire or chemical burn hazard if mistreated. Do not recharge, disassemble, heat above 100°C (212°F) or incinerate.
- Replace the battery with a CR1616, made by one of the following companies: Panasonic, Hitachi Maxell, Sony, Toshiba, Varta, Renata. Use of another battery may present a risk of fire or explosion.
- The used battery should be returned to the supplier for safe disposal.

### **Cautions:**

- Do not pick up the battery using tweezers or other metal tools — this will cause a short circuit.
- Wipe the battery with a clean, dry cloth to ensure proper contact.
- Keep the battery pack out of reach of children — if it is swallowed, contact a physician immediately, as the battery case may break down and the battery fluids damage the stomach and intestines.
- Do not disassemble, heat or immerse the battery in water, to avoid the risk of explosion.

# Maintenance

## Cautions

E

### **Avoid high temperatures and high humidity.**

- Do not leave the camcorder inside a car in hot weather, for example.
- Be careful of heat radiating from video lighting equipment.
- Do not take the camcorder into a humid room.

### **Avoid sudden changes in temperature.**

- If you take the camcorder from a cold place to a warm place, condensation may form on the lens and internal parts (  139).

### **Do not point the lens or viewfinder at strong light sources.**

- Never point it at the sun, and do not leave it aimed at a bright subject.
- Be especially careful when leaving the camcorder on a tripod.

### **Avoid magnetic or electric fields.**

- Do not use the camcorder close to TV transmitters, portable communication devices or other sources of electric or magnetic radiation. They may cause picture interference, or permanently damage the camcorder.

### **Do not expose the camcorder to water.**

- Cover the camcorder when you are recording in rain or mist.
- There is a risk of electric shock if water gets inside the camcorder — contact qualified service personnel as soon as possible.

### **Protect the lens.**

- Sand and dust can damage the lens — be especially careful on windy days.

### **Handle the camcorder gently.**

- Vibration or shock can cause damage.
- Do not use the viewfinder, LCD panel, battery pack or built-in flash as a carrying handle.

### **Do not disassemble the camcorder.**

- This is very dangerous as there is a risk of electric shock — if the camcorder does not function properly, take it to qualified service personnel.

## Storage

If you do not intend to use the camcorder for some time, store it in an area which is free of dust and moisture, and where the temperature is no higher than 30°C (86°F). After storage, check each part and function of your camcorder to make sure everything is still working properly.



### Note:

- These cautions also apply to accessories such as battery packs and cassettes.

## Maintenance

### Viewfinder

- Clean the viewfinder screen using a cotton swab. First, pull the viewfinder out until it stops. Then, press and hold the finder release button with a sharp object and pull the viewfinder all the way out. To reattach the viewfinder, first position the base horizontally and align it with the viewfinder's base. Then press it until it clicks back into place.
- The viewfinder screen scratches easily. Take care when cleaning.

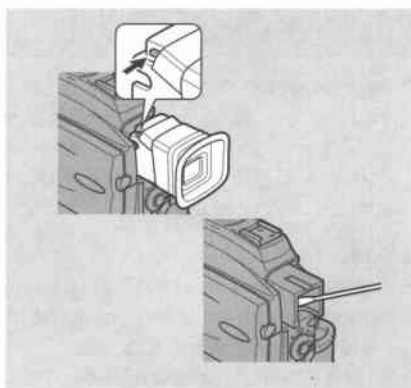

### LCD

- Clean the LCD screen using a commercially available cleaning cloth for glasses.
- Where there is a big change in temperature, moisture may form on the surface of the screen. Wipe clean with a soft, dry cloth.
- At low temperatures the display may appear to be much darker than usual. This is not a fault, and as the screen warms up the display will return to normal.

### Camcorder body and lens

- Use a soft, dry cloth to clean the camcorder body or lens. Never use chemically treated cloth or volatile solvents such as paint thinner.

### Video heads

- When mosaic-like noise appears on the playback picture, the video heads may be dirty. When the video heads are badly contaminated, the camcorder may show a blank blue screen or a warning.
- For the best picture possible, after using the camcorder for approximately 20 hours, clean the video heads using Canon's DVM-CL Digital Video Head Cleaning Cassette. If the "noise" remains, repeat the cleaning (up to maximum of 5 times).
- Do not use a wet-type cleaning cassette, as this can cause damage.



## Using the camcorder abroad

### Power sources

- You can use the compact power adapter to operate your camcorder and charge battery packs in any country where the electricity supply is between 100 and 240 V AC, 50/60 Hz. Contact your Canon dealer for information about plug adapters for overseas use.

### TV playback

- Although you can always play back your recordings on the LCD screen, your camcorder can only be connected to TVs which use its PAL system. This TV system is used in the following countries:  
Algeria, Australia, Austria, Bangladesh, Belgium, Brunei, China, Denmark, Finland, Germany, HongKong, Iceland, India, Indonesia, Ireland, Italy, Jordan, Kenya, Kuwait, Liberia, Malaysia, Malta, Mozambique, the Netherlands, New Zealand, North Korea, Norway, Oman, Pakistan, Portugal, Qatar, Sierra Leone, Singapore, South Africa, Spain, Sri Lanka, Swaziland, Sweden, Switzerland, Tanzania, Thailand, Turkey, Uganda, United Arab Emirates, United Kingdom, Yemen, former Yugoslavia, Zambia.



## Condensation

E

Condensation may form on the camcorder when it is moved from a cold place to a warm place. Using the camcorder while condensation is present can damage both the tape and the camcorder.

Condensation may become a problem:

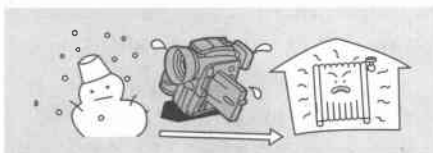

When you take the camcorder from a cold place to a warm room

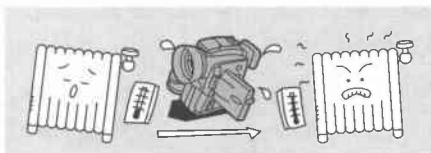

When a cold room is heated rapidly

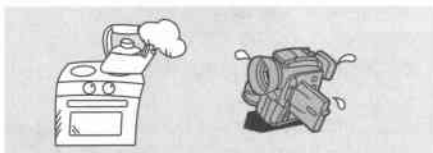

When the camcorder is left in a humid room

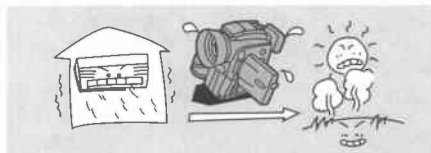



When the camcorder is taken from an air-conditioned room to a warm, humid place

### Protecting the camcorder from condensation

- Before you take the camcorder to a warm or humid place where condensation is likely to be a problem, unload the cassette and put the camcorder in a plastic bag. Wait until the camcorder reaches room temperature before you take it out of the bag.

### What happens when condensation is detected

- “CONDENSATION HAS BEEN DETECTED” is displayed for approximately four seconds. Then, the power indicator flashes and the  mark flashes in the display. If there is a cassette in the camcorder, it stops automatically and “REMOVE THE CASSETTE” is displayed for approximately 4 seconds and then  flashes in the display. If you have the beep turned on, it will sound.
- The camcorder may not detect the condensation immediately — the condensation warning may not start flashing for 10 to 15 minutes.
- You cannot load a cassette when condensation is detected.

### What you should do

- Remove the cassette, leave the cassette compartment open, and turn the camcorder off.
- Leave it in a dry place until the condensation evaporates. After the condensation warning stops flashing, wait at least another hour before trying to use the camcorder.

## Troubleshooting

E

Refer to this checklist first if you have any problems with your camcorder. Possible explanations are given for each problem on the list — turn to the page numbers in parentheses for more information.

Make sure that the camcorder is properly connected if you are using it with a TV or VCR. Consult your dealer or service outlet if problems persist.

### Recording/Playback

#### Problem

❓ **Nothing happens when I press the buttons.**

❓ **The camcorder turned itself off.**

❓ **The cassette compartment stopped mid-operation while loading/unloading a cassette.**

❓ **The start/stop button doesn't work.**

❓ **The  $\downarrow$  mark flashes red in the display during charging the flash.**

❓ **There's no picture in the display.**

❓ **There's a blank blue screen in the display.**

#### Cause and/or what to do about it

- The camcorder is not set to the appropriate mode ( □ 17, 27).
- The cassette is not loaded or is set for erasure prevention ( □ 15-16).
- The cassette has reached the end.
- The power source is not properly connected, or the battery pack is exhausted or not properly attached ( □ 10-14, 134).
- The function cannot be used in that recording program ( □ 56).
- The camcorder was in record pause mode for more than about 5 minutes ( □ 17, 107).
- The battery pack is exhausted ( □ 11-14, 134).
- The battery pack's power is exhausted. Recharge or change to a new battery pack ( □ 11-14).
- The cassette is not loaded or is set for erasure prevention ( □ 15-16).
- The cassette has reached the end.
- The camcorder is malfunctioning. Remove and then replace power source.
- The camcorder is not set to the appropriate mode ( □ 17, 27).
- You are attempting to play back or record copyright protected material ( □ 89).
- The video heads are badly contaminated ( □ 138).

## ❓ The camcorder won't focus.

- The camcorder is on manual focus (□ 77).
- The viewfinder lens needs adjusting (□ 131).
- The lens is dirty (□ 137).



### Note:

- Some subjects are not suitable for autofocus. In these situations, you will often get better results using manual focus (□ 77). Focus on something which is about the same distance away, lock the focus, and then point the camcorder at your original, hard-to-focus subject.



Horizontal stripes



Many subjects at different distances



Behind glass



Without much contrast (e.g. a white wall)



Reflective surfaces  
(e.g. shiny car surfaces)



Fast moving objects



Dark subjects



Night scenes

## Recording/Playback (Cont.)

### Problem

❓ Some/all of the digital effects don't work.

❓ The ► (play) button doesn't work.

❓ There's a bright stripe on the screen.



❓ The playback picture is rough (with mosaic-like noise).

### Cause and/or what to do about it

- There are a number of restrictions on using the digital effects (□ 60-66).
- The camcorder is not set to TAPE PLAY (MVX1i: TAPE PLAY (VCR)) mode (□ 27).
- The cassette is not loaded (□ 15).
- The cassette has reached the end.
- When recording in dark places a bright light in the scene may cause a vertical light bar ("smear") to appear. This is a normal feature of camcorders.
- The video heads need cleaning (□ 138).

- ❓ **There's no picture on the TV screen, even though the tape is moving.**
- The video heads need cleaning (□ 138).
- The TV/VIDEO selector on the TV isn't set to VIDEO (□ 31-33).
- ❓ **There's no sound coming from the speaker during playback.**
- The speaker has been turned off with the selector dial (□ 30).
- Headphones are being used.

## Memory card operations

### Problem

❓ **The memory card will not insert.**

❓ **The □ mark flashes red in the display even though a memory card has been inserted.**

❓ **Nothing happens when I press the buttons.**

### Cause and/or what to do about it

- It is not turned the right way (□ 104). Turn it the right way and try inserting again.
- Turn the camcorder's power off and back on again and remove and reinsert the card. If the mark continues to flash, format the memory card.
- The camcorder is not set to CARD CAMERA or CARD PLAY (MVX1i: CARD PLAY (VCR)) (□ 107, 111) mode.
- The memory card is not inserted (□ 104).
- You are using an SD Memory Card and it is set for erasure prevention. Change the position of the protect switch.
- The memory card is full. Erase images (□ 114) or insert a new memory card.
- The power source is not properly connected, or the battery pack is exhausted or not properly attached (□ 10-14, 134).
- The function cannot be used in that recording program (□ 56).
- The memory card is not loaded (□ 104).
- You are using an SD Memory Card and it is set for erasure prevention. Change the position of the protect switch.
- The memory card is full. Erase images (□ 114) or insert a new memory card.

❓ **The PHOTO button doesn't work.**

**? The image cannot be erased.**

- You have reached the maximum file number. Set the file numbering to RESET through the menu (□ 106) and insert a new memory card.
- You are using an unformatted memory card. Format the card (□ 127).
- The image is protected (□ 113).
- You are using an SD Memory Card and it is set for erasure prevention. Change the position of the protect switch.

## Miscellaneous

### Problem

**? The wireless controller doesn't work.**

**? The power indicator is flashing.**

**? The camcorder malfunctions.**

**? The DV cable is connected correctly, but there's nothing in the display.**

**? The camcorder becomes warm during use.**

### Cause and/or what to do about it

- The remote sensor mode is set to OFF (OFF) in the menu (□ 46).
- The remote sensor modes of the wireless controller and the camcorder itself are different (□ 46).
- The batteries are dead or not inserted.
- Check the screen displays (□ 148).
- External interference may cause the camcorder's microprocessor to malfunction temporarily. If random letters appear in the display or if normal operation is interrupted, remove and then replace the power source.
- Remove the cable and then reconnect it or turn the power off and back on again.
- This is not a malfunction.

# The MVX1/MVX1i System Diagram (Availability differs from area to area)

E

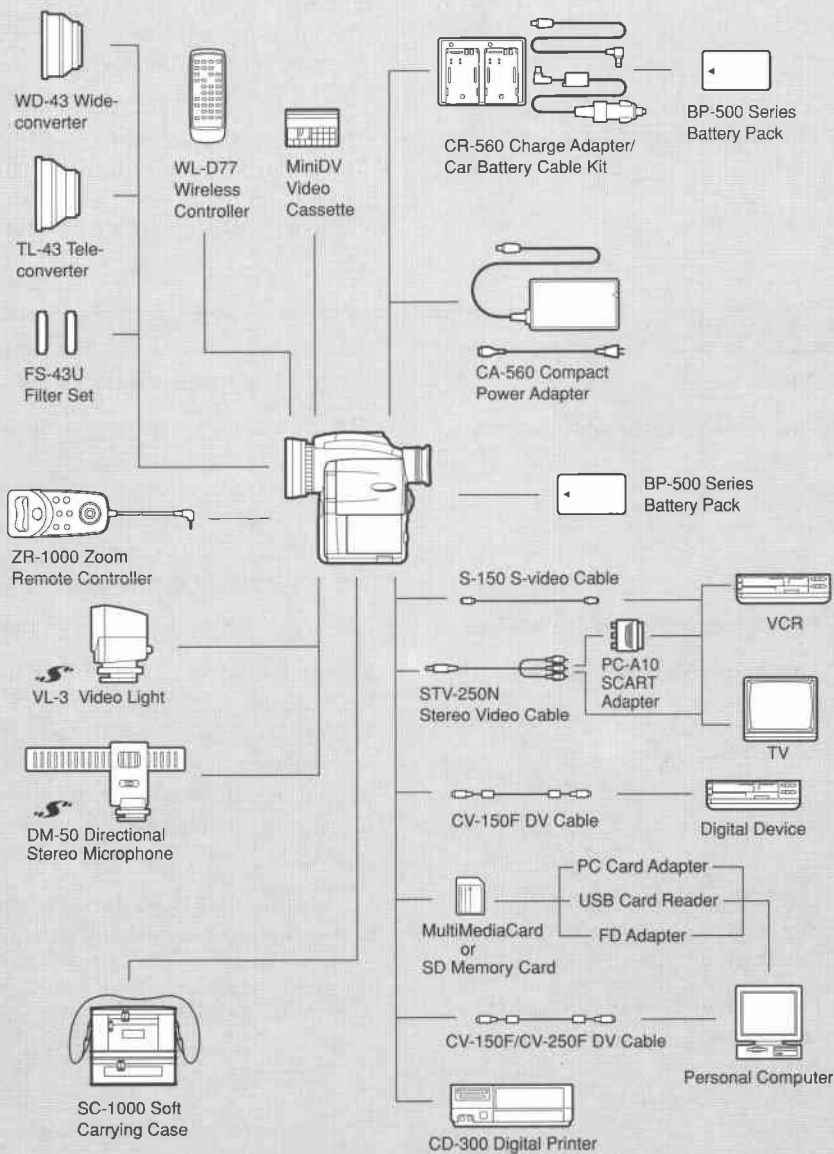

## Optional Accessories

### BP-500 Series Battery Packs

Extra batteries for use with the MVX1/MVXi.

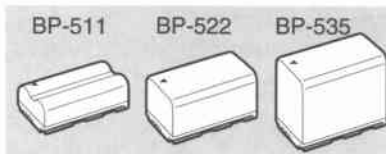

E

### CR-560 Charge Adapter/Car Battery Cable Kit

Connect the car battery cable to power your camcorder or recharge battery packs on the move. The car battery cable plugs into your car's cigarette lighter socket and runs off a 12-24 V DC negative ground battery.

Also, when used with the CA-560 Compact Power Adapter, this charge adapter can charge the BP-500 series lithium ion battery packs from a mains outlet.

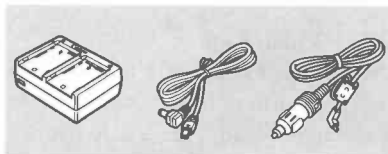

### TL-43 Tele-converter

This tele-converter lens increases the focal length of the camcorder lens by a factor of 1.7.

- The image stabilizer is not as effective as usual when the tele-converter is attached.

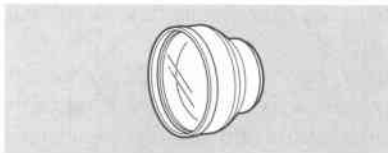

### WD-43 Wide-converter

This lens decreases focal length by a factor of 0.7, giving you a wide perspective for indoor shots or panoramic views.

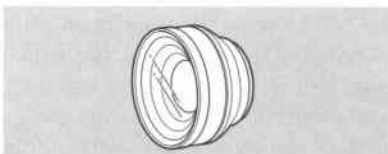

### FS-43U Filter Set

Neutral density and MC protector filters to help you take control of difficult lighting conditions.

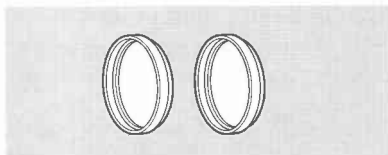

### VL-3 Video Light

Attach the Video Light to a camcorder when recording in dark rooms. When on its automatic setting, the Video Light turns on/off automatically according to the brightness level of shooting conditions.



### DM-50 Directional Stereo Microphone

This highly sensitive, super-directional microphone attaches to a camcorder's advanced accessory shoe. It is a highly sensitive microphone that can be switched between functioning as a directional microphone (monaural) or a stereo microphone that also clearly picks up sounds arriving from the front of the microphone, for full recorded sound.

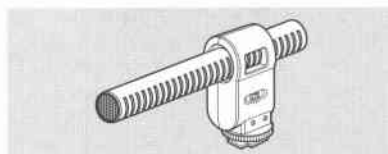

### Zoom Remote Controller ZR-1000

When this product is plugged into the LANC  terminal of a Canon camcorder, it is possible to control functions such as the start and stop of recording and the zoom and focusing functions while the camcorder is mounted on a tripod, without touching the camcorder body itself.





### SC-1000 Soft Carrying Case

A handy camcorder bag with padded compartments and plenty of space for accessories.



E

### CD-300 Digital Printer

This 300 dpi resolution printer is perfect for printing out the high quality images taken with digital camcorders. Print out panorama prints, pictures without a white border, multiple-picture index cards, and add titles to pictures. A clear overcoat adds luster to your prints and reduces colour fading.

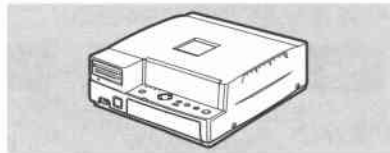

This mark identifies genuine Canon video accessories. When you use Canon video equipment, we recommend Canon-brand accessories or products bearing the same mark.

## Screen Displays

E

To display the date and time, press the DATA CODE button. See also p. 80.

Press the wireless controller's TV SCREEN button or turn TV SCREEN on through the menu to see the other displays on the TV screen. (The displays appear white on-screen.) They will not be added to any recordings you make with the camcorder.

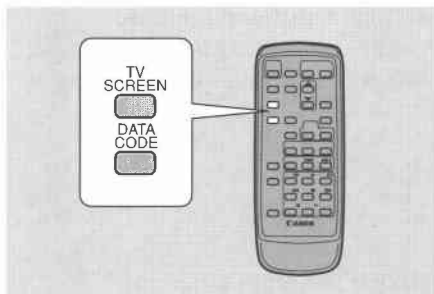

TAPE + CAMERA, CARD + CAMERA

**MENU**  
( 37)

▶DISP. SET UP

▶TV SCREEN...ON

**To turn TV SCREEN off, open the menu and select DISP. SET UP. Then select TV SCREEN, set it to OFF and close the menu.**

For instructions on how to hook the camcorder up to your TV, see p. 31.

### Turning off the LCD screen displays



You can turn off the displays to give you a clear screen for playback.

TAPE + (PLAY / PLAY/VCR), CARD + (PLAY / PLAY/VCR)

**MENU**  
( 37)

▶DISP. SET UP

▶DISPLAYS...ON

**To turn the display off, open the menu and select DISP. SET UP. Then select DISPLAYS, set it to OFF <PLAYBK> and close the menu.**

- If you turn the displays off, the LCD screen will be completely blank (including connected TV screen), but the camcorder will continue to show warning/caution displays when necessary, and the data code appears in the display if it is set to ON.
- When operating the camcorder, the displays appear for 2 seconds. However, the displays do not disappear when displaying an index screen.



indicates a flashing display.

Record pause mode  
( 17)



Recording ( 18)



The backup battery is not properly installed, or needs replacing  
( 135).



Shows how much battery power remains ( 134).



The battery pack is exhausted ( 134).



No cassette is loaded, or it is set for erasure prevention ( 15, 16).



Remaining tape  
(Green: more than five minutes.  
Yellow: less than five minutes.  
Red: final few seconds.)



...finally, it tells you when you have completely run out of tape.



The camcorder is ejecting the tape ( 15).



The safety mechanism is activated. Unload the cassette and turn the camcorder off. Turn it on again and reload the cassette.



Recording mode ( 19)



Playback is stopped ( 27).



Normal playback ( 27)



Fast forward ( 27)



Rewind ( 27)



Fast forward playback ( 28)



Rewind playback ( 28)



Frame advance playback ( 28)



Frame reverse playback ( 28)



Playback pause (forward and reverse) ( 28)



Slow playback (forward and reverse) ( 28)



×2 playback (forward and reverse) ( 29)



×1 playback (forward and reverse) ( 29)



Photo Search ( 83)



Date Search ( 83)

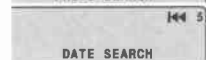

Zero set memory (forward and reverse) ( 84)

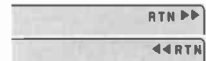

AV Insert Editing ( 92)  
(MVX1i only)

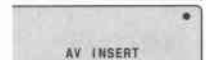
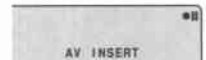

Audio Dubbing ( 95)

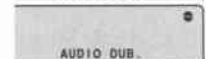
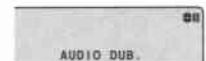

Zoom display ( 22):  
Optical zoom



Optical plus 40×  
digital zoom



Optical plus 200×  
digital zoom



Zoom in



Zoom out



The image stabilizer  
is turned on ( 55).



CAM. MENU  
( 39)

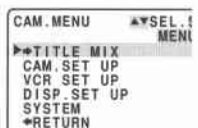

PLAY MENU  
(MVX1i: VCR  
MENU)  
( 40)

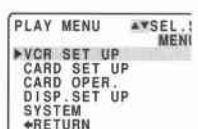

C.CAM. MENU  
( 42)

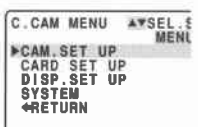

C.PLAY MENU  
( 43)



CARD PHOTO  
REVIEW MENU  
( 114)

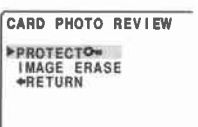

FILE OPER. MENU  
( 115)

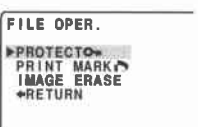

The remote sensor is  
turned off ( 46).



Self-timer countdown  
( 69)



Zero set memory  
( 84)



Audio mode ( 67)



Data code ( 80)

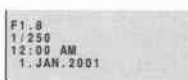

Photo mode ( 51)



- Setting the AF/AE. mark flashes white
- AF/AE locked. mark lights up green
- Timer



Built-in Flash ( 53)

Auto



Red-eye reduction auto



Flash on

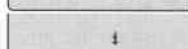

Flash off

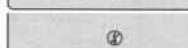

Recording programs  
( 56).



Accessory is attached  
to advanced accessory  
shoe ( 71, 72).



Manual exposure display ( 73):  
Exposure locked

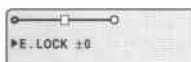

Brighter than standard exposure level

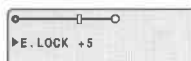

Darker than standard exposure level



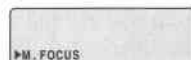

Manual focus is selected ( 77).



Shutter speed ( 75)



White balance is ( 78)

Set   
Indoor   
Outdoor 

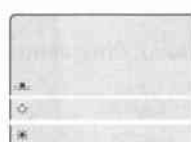

The 16:9 mode: the display flashes when the effect is being selected, and appears steadily when it is activated ( 20).



Digital effects. The display flashes when the function is being selected and appears steadily when it is activated ( 60).



The wind screen is turned on ( 68).

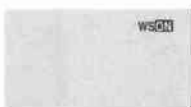

Volume level ( 30):  
Speaker

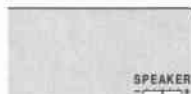

Headphones

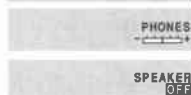

Audio output ( 100)

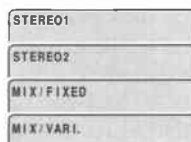

Mix balance ( 100)



Audio input and  
Microphone input (MVX1i only, 98)  
Audio input



Microphone input

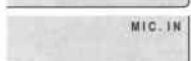

DV input ( 87, 110)  
(MVX1i only)

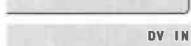

Condensation warning ( 139)



## Memory Card Displays

No memory card is inserted ( 104)

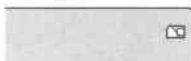

Image quality ( 104)  
Standard



Fine



Image resolution ( 105)



Folder number-File number ( 106)



Slide show in progress  
( 112)

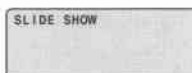

Recording to a  
memory card  
( 107)



The number of still  
images that can still be  
recorded on the  
memory card ( 107)  
(Green: 6 or more  
images.  
Yellow: Between 1 and  
5 images  
Red: No more images)



Accessing a memory  
card ( 111)



Current still  
image/Total number of  
still images on the  
memory card  
( 111)

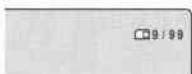

Protect mark ( 113)

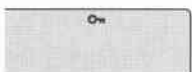

Title mix ( 121)



Print mark ( 113)



Data code ( 80)



## Time Code

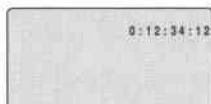

This records counter information, including hour, minute, second, and frame number on a special data code area on the tape itself. It is reset automatically when a new tape is loaded. In TAPE CAMERA mode, the frame number doesn't appear in the display.

## Recording reminder

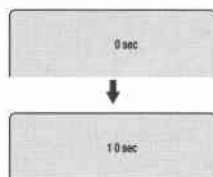

When you start recording, the camcorder counts from 0SEC to 10SEC. Shots which are shorter than ten seconds may be difficult to edit later. On the other hand, if you are not planning to edit the recording, remember that a shot which does not contain action should generally last no longer than 10 seconds.

## Caution phrases

The camcorder displays various caution phrases — they appear for 4 seconds before disappearing.

Appears each time you turn the power on, until you set the time zone, date and time (  48).

SET THE TIME ZONE,  
DATE AND TIME

Appears as a warning to protect the tape and also when condensation is detected. Remove the tape as soon as possible after the camcorder has displayed the caution.

REMOVE THE CASSETTE

Appears when the battery pack is exhausted (  134).

CHANGE THE BATTERY PACK

Refer to p.89

COPYRIGHT PROTECTED  
PLAYBACK IS RESTRICTED

Appears when the tape has reached the end.

TAPE END

Refer to p.89 or p.90

COPYRIGHT PROTECTED  
DUBBING RESTRICTED

Refer to p.16

THE TAPE IS SET FOR  
ERASURE PREVENTION

Appears when you try to do audio dubbing or AV insert (MVX1i only) on a tape recorded in any mode other than SP mode (  92, 95).

CHECK THE CASSETTE  
[REC MODE]

Appears when, during DV dubbing, the DV cable is disconnected or the power of the digital equipment connected to the camcorder is turned off (MVX1i only).

CHECK THE DV INPUT

Appears when you try to do audio dubbing on a tape recorded in 16-bit audio or 12-bit, 4-channel mode (  95).

CHECK THE CASSETTE  
[AUDIO MODE]

Refer to p.139

CONDENSATION  
HAS BEEN DETECTED



Appears when the camcorder detects a blank section of a tape during audio dubbing or AV insert (MVX1i only) (  92, 95).

CHECK THE CASSETTE  
[BLANK]

Appears immediately after you start recording, and the video heads are badly contaminated. Make sure to clean the video heads when this caution appears. (  138)

HEADS DIRTY,  
USE CLEANING CASSETTE

### Memory card caution phrases

An error has occurred with the memory card. The camcorder can not record or play back. A temporary card error is also possible. If CARD ERROR disappears after 4 seconds and  flashes red, turn the camcorder's power off and back on again, and remove and reinsert the card. If  flashes green, recording or playing back is possible.

CARD ERROR

There is no more remaining memory on the memory card. Change the card or erase images.

CARD FULL

You have reached the maximum file or folder number. (  106)

NAMING ERROR

The image has been recorded in an incompatible JPEG format or other format that the camcorder can not play back, or the image data has been damaged.

UNIDENTIFIABLE  
IMAGE

Appears if you have tried to mark 51 or more images for printing, or if a mark file cannot be edited. (  113)

PRINT MARK ERROR

A memory card has not been inserted into the camcorder. (  104)

NO CARD

There are no images recorded on the memory card.

NO IMAGES

You are using an SD Memory Card and it is set for erasure prevention. Change the position of the protect switch.

THE CARD IS SET FOR  
ERASURE PREVENTION

Appears when you press the start/stop button in CARD CAMERA mode. The image isn't recorded on the cassette or memory card.

IN CARD POSITION



# Specifications

## MVX1/MVX1i

**E**



**Power Supply (rated):** 7.4 V DC

**Power Consumption (while recording with the AF turned on):** 4.7 W (Using viewfinder), 5.4 W (Using LCD screen)

**Television system:** CCIR standard (625 lines, 50 fields) PAL colour signal

**Video recording system:** 3 rotary heads, helical scanning DV system (Consumer digital VCR SD/SDL system)

Digital component recording

**Audio recording system:** PCM digital sound: 16 bit (48 kHz/ 2 ch), 12 bit (32 kHz/ 4 ch),  SP and  LP: 12 bit only (32 kHz/ 2 ch)

**Image sensor:** 1/3.6" CCD (charge coupled device), approx. 1.33 million pixels (effective: 1.25 million pixels (recording still image onto a memory card) / 690,000 pixels (recording movie and still image to a tape))

**Tape format:** Videocassettes bearing the  mark.

**Tape speed:**

SP: 3/4 ips (18.83 mm/s),

LP: 1/2 ips (12.57 mm/s),

 SP: 3/8 ips (9.42 mm/s),

 LP: 1/4 ips (6.29 mm/s)

**Maximum recording time (with an 80 min. cassette):**

SP: 80 min., LP: 120 min.,

 SP: 160 min.,  LP: 240 min.

**Fast forward/ rewind time:**

Approx. 2 min. 20 sec. (with a 60 min. cassette)

**Lens:** F/1.6–1.8, 10× power zoom, 4.2–42 mm (8× power zoom, 5.25-42 mm in CARD CAMERA mode)

**Focusing system:** TTL autofocus, manual focusing possible

**Minimum focusing distance:** 3ft 3<sup>3</sup>/<sub>8</sub> in (1 m) (3/8 in (1 cm) on maximum wide angle)

**Maximum shutter speed:** 1/8,000 sec. (1/500 sec. when using a memory card)

**Minimum illumination:** 3 lx (using the Low Light program in TAPE CAMERA mode)

**Recommended illumination:**

More than 100 lx

**Filter diameter:** 43 mm

**Viewfinder:** 0.55 in, TFT colour LCD, approx. 113,000 pixels

**LCD screen:** 2.5 in measured diagonally, TFT colour, approx. 200,000 pixels

**Microphone:** Stereo electret condenser microphone

**Flash:** Built-in, Auto pop-up flash

**Recording media:** MultiMediaCard, SD Memory Card

**Number of recording pixels:** 1280 × 960 pixels, 640 × 480 pixels

**Image format:** Design rule for Camera File system (DCF), Digital Print Order Format (DPOF) compliant (only images marked for printing)

**File format:** JPEG (compression mode: Fine/Standard)

**Estimated MultiMediaCard MMC-8M capacities (approx.):**

1280 × 960: Fine 17 images/Standard 32 images, 640 × 480: Fine 61 images/Standard 106 images

- The actual number you can record varies depending on the images. Remember that the sample images recorded on the supplied MultiMediaCard are included in the total number.

**DV Terminal\*:** Special 4-pin connector (conforms to IEEE1394)

**AV terminal input/output:** ø 3.5 mm

Audio input\*\*:

–10 dBV/at least 40 kohms, (L, R),

unbalanced

output: –10 dBV (47 kohm load)/ less than 3 kohms, unbalanced

Video: 1 Vp-p/75 ohms unbalanced

**S-video terminal\*:**

1 Vp-p (Y signal), 0.3 Vp-p (C signal)

**MIC terminal input:** ø 3.5 mm stereo minijack, –57 dBV (with 600 ohm mic)/ at least 5 kohms

**Headphone terminal:** ø 3.5 mm stereo minijack

**LANC**  **terminal:**  $\varnothing$  2.5 mm mini minijack

**Operating temperature range:**  
0°–40°C (32°–104°F)

**Dimensions:** 66 × 131 × 129 mm  
(2 1/2 × 5 1/8 × 5 1/8 in)

**Weight:** 660 g (1lb 7 1/4 oz)

### BP-512 Battery Pack

**Battery type:** Rechargeable lithium ion battery

**Rated voltage:** 7.4 V DC

**Operating temperature:** 0°–40°C  
(32°–104°F)

**Battery capacity:** 1100 mAh

**Dimensions:** 38 × 21 × 55 mm  
(1 1/2 × 7/8 × 2 1/8 in)

**Weight:** 70 g (2 1/2 oz)

- \* MVX1: Output only.  
MVX1i: Input/output.
- \*\* MVX1i only.

Weight and dimensions are approximate.  
Errors and omissions excepted.  
Subject to change without notice.

# Index

16:9, 20

## A

Abroad, Using the Camcorder, 138  
Accessories, 5, 145  
Adapter, AC, 10-12, 14  
AE Programs, 56  
Analog line-in, 90  
Audio Dubbing, 95  
Audio Mix, 100  
Audio Mode, 67  
Audio Output, 100  
Audio Recording  
    and Playback, 67, 100  
Audio/Video Terminal, 31  
Auto, 58  
Autofocus, 77  
AV Insert, 92

## B

Backup Battery, 135  
Basic Recording, 17  
Battery Charger, 13-14  
Battery Pack, 11, 13-14, 133  
Beep, 21

## C

Cables, 5, 31  
Cassettes, 15  
Charging the Battery Pack,  
    11, 13-14, 133  
Choosing a Recording Program, 56  
Cleaning the Camcorder, 137  
Clock, 50  
Combining Images, 121  
Condensation, 139  
Connecting to a PC, 102  
Connection to TV or VCR, 31  
Copying from Cassette to  
    Memory Card, 125  
Copying from Memory Card to  
    Cassette, 126

## D

Data Code, 80  
Date and Time, 50  
Date Search, 83  
Digital Effects, 60  
Digital Zoom, 22  
DV Dubbing, 86

## E

Easy Recording, 58  
Editing to a VCR, 85  
Effects, 62  
Erasing Still Images from a  
    Memory Card, 114, 119  
Exposure, 73  
Extended Recording Time  
    Function, 19  
External Microphone, 67, 95, 97

## F

Faders, 61  
Fast Forward, 27  
Feedback, 33  
File Numbers, 106  
Finding Your Way Around  
    the MVX1/MVX1i, 7  
Flash, 53  
Focusing, 77  
Formatting a Memory Card, 127

## H

Head Cleaning, 138  
Headphones, 30

## I

Image Quality, 104  
Image Resolution, 105  
Image Stabilizer, 55  
Index Screen, 112  
Introducing the MVX1/MVX1i, 6

E

**E****L**

LANC, 85  
LCD Screen, 24  
Lens Cap, 132  
Lens Hood, 131  
Loading Cassettes, 15  
Low Light, 59  
LP Mode, 19

**M**

Maintenance, 136  
Making Better Videos, 34  
Manual Exposure Control, 73  
Manual Focus, 77  
Memory Card Introduction, 103  
Menus, 37  
Microphone, 67, 72, 95, 97  
Monitor Recording, 26  
Multi-Image Screen, 65

**O**

Optional Accessories, 145

**P**

Pause, Record, 17  
PC Connection, 102  
Photo Search, 83  
Playback, 27  
Playback Connection, 31  
Playback Pause, 28  
Portrait, 58  
Power Adapter, 10-12, 14  
Powering Your Camcorder, 10  
Pre-Marked Position, 84  
Preparing the Camcorder, 131  
Preventing Accidental Erasure,  
113, 116  
Print Mark, 113, 117  
Problems, 140  
Progressive Photo, 107  
Protect, 113, 116

**R**

Recharging the Battery Pack, 133  
Recording, 17, 107  
Recording from Cassette to  
Memory Card, 109  
Recording from DV Device to  
Memory Card, 110  
Recording Programs, 56  
Record Pause Mode, 17  
Record Review, 36  
Record Search, 36  
Remote Control, 45  
Remote Sensor, 45-46  
Rewind, 27

**S**

S1 video terminal, 32  
Sample images, 129  
Sand & Snow, 59  
Screen Displays, 148  
SD Memory Card, 103, 107, 128  
Self-Timer, 69  
Shutter Sound, 106  
Shutter Speed, 75  
Slide Show, 112  
Speaker, 30  
Specifications, 12, 130, 155  
SP Mode, 19  
Sports, 58  
Spotlight, 59  
Still Picture, 51, 107  
Storage, 137  
S-video, 32  
System Diagram, 144

## T

Tally Lamp, 21  
Tape Protection, 16  
Telephoto, 22  
Temperature, 12, 133, 136, 156  
Time Code, 152  
Time Zone, 48  
Tips for Making Better Videos, 34  
Tripod, 34  
Troubleshooting, 140  
TV, 31, 148

## V

VCR, 31  
Videocassettes, 15  
Video Heads, 138  
Video Light, 71  
Viewfinder, 131, 137  
Viewing Still Images, 111

## W

White Balance, 78  
Wide-angle, 22  
Wide Screen TV, 20  
Wind Screen, 68  
Wireless Controller, 45

## Z

Zero Set Memory, 84  
Zooming, 22

## Menu at a Glance

Use the list below to quickly navigate the camcorder's menu. Functions are listed alphabetically.

E

Function	First make sure the camera is set to...				Then select it from this submenu and set.
	TAPE + CAMERA	TAPE + PLAY*	CARD + CAMERA	CARD + PLAY*	
16:9 effect	<input type="radio"/>				CAM.SET UP
6-sec. Date		<input type="radio"/>			DISP.SET UP
Audio dub (MVX1i only)		<input type="radio"/>			VCR SET UP
Audio mode	<input type="radio"/>	<input type="radio"/> **			VCR SET UP
Beep	<input type="radio"/>	<input type="radio"/>	<input type="radio"/>	<input type="radio"/>	SYSTEM
Brightness	<input type="radio"/>	<input type="radio"/>	<input type="radio"/>	<input type="radio"/>	DISP.SET UP
Copy - card to cassette				<input type="radio"/>	CARD OPER.
Copy - cassette to card		<input type="radio"/>			CARD OPER.
Data code		<input type="radio"/>			DISP.SET UP
Date/time display	<input type="radio"/>		<input type="radio"/>		DISP.SET UP
Date/time select		<input type="radio"/>		<input type="radio"/>	DISP.SET UP
Date/time set	<input type="radio"/>		<input type="radio"/>		SYSTEM
Digital zoom	<input type="radio"/>				CAM.SET UP
Displays		<input type="radio"/>		<input type="radio"/>	DISP.SET UP
Erase				<input type="radio"/>	CARD OPER.
Erase all print marks				<input type="radio"/>	CARD OPER.
File numbers		<input type="radio"/>	<input type="radio"/>		CARD SET UP
Format				<input type="radio"/>	CARD OPER.
Image resolution			<input type="radio"/>		CARD SET UP
Image stabilizer	<input type="radio"/>		<input type="radio"/>		CAM.SET UP

Function	First make sure the camera is set to...				Then select it from this submenu and set.
	TAPE + CAMERA	TAPE + PLAY	CARD + CAMERA	CARD + PLAY*	
Mirror mode	<input type="radio"/>		<input type="radio"/>		DISP.SET UP
Mix level	<input type="radio"/>				➔ TITLE MIX
Mix type	<input type="radio"/>				➔ TITLE MIX
Output channel		<input type="radio"/>			VCR SET UP
Print mark				<input type="radio"/>	CARD OPER.
Protect				<input type="radio"/>	CARD OPER.
Quality		<input type="radio"/>	<input type="radio"/>		CARD SET UP
Record mode	<input type="radio"/>	<input type="radio"/> **		<input type="radio"/>	VCR SET UP
Remote sensor mode	<input type="radio"/>	<input type="radio"/>	<input type="radio"/>	<input type="radio"/>	SYSTEM
Shutter sound			<input type="radio"/>		CARD SET UP
Shutter speed	<input type="radio"/>		<input type="radio"/>		CAM.SET UP
Tally lamp	<input type="radio"/>	<input type="radio"/>		<input type="radio"/>	SYSTEM
Time zone/DST	<input type="radio"/>		<input type="radio"/>		SYSTEM
Title mix	<input type="radio"/>				➔ TITLE MIX
TV screen	<input type="radio"/>		<input type="radio"/>		DISP.SET UP
White balance	<input type="radio"/>		<input type="radio"/>		CAM.SET UP
Wind screen	<input type="radio"/>	<input type="radio"/>			VCR SET UP

\*  for MVX1i

\*\* MVX1i only

# Canon

**CANON INC.**

**Canon Europa N.V.**

P.O. Box 2262, 1180 EG Amstelveen, the Netherlands

**Canon UK Ltd.**

Ribcon Way  
Luton Bedfordshire LU4 9UR  
Telephone 0870-241-2161

**Canon Australia Pty. Ltd**

1 Thomas Holt Drive, North Ryde, N.S.W. 2113, Australia  
Telephone 805-2000, Fax 887-4484

**Canon New Zealand Ltd**

Fred Thomas Drive, Takapuna, P.O. Box 33-336, Auckland, New Zealand  
Telephone 486-1570, Fax 486-6420

**Canon Singapore Pte. Ltd**

79 Anson Road #09-01/06, Singapore 079906  
Telephone (65)-532-4400, Fax (65)-221-2939

**Canon Hongkong Company Ltd**

9/F, The Hong Kong Club Building, 3A Chater Road, Central, Hong Kong

**Canon Latin America, Inc.**

Sales & Enquiries: 6505 Blue Lagoon Drive Suite 325 Miami FL 33126 USA



Printed on 70% reused paper.

0024W505  
PUB.DIE-162  
0701A/Ni0.4

© CANON INC. 2001  
DY8-9020-098-000

PRINTED IN JAPAN  
IMPRIME AU JAPON



## Free Manuals Download Website

<http://myh66.com>

<http://usermanuals.us>

<http://www.somanuals.com>

<http://www.4manuals.cc>

<http://www.manual-lib.com>

<http://www.404manual.com>

<http://www.luxmanual.com>

<http://aubethermostatmanual.com>

Golf course search by state

<http://golfingnear.com>

Email search by domain

<http://emailbydomain.com>

Auto manuals search

<http://auto.somanuals.com>

TV manuals search

<http://tv.somanuals.com>