

Canon

Digital Video Camcorder Instruction Manual

English

MVX350i / MVX330i / MVX300

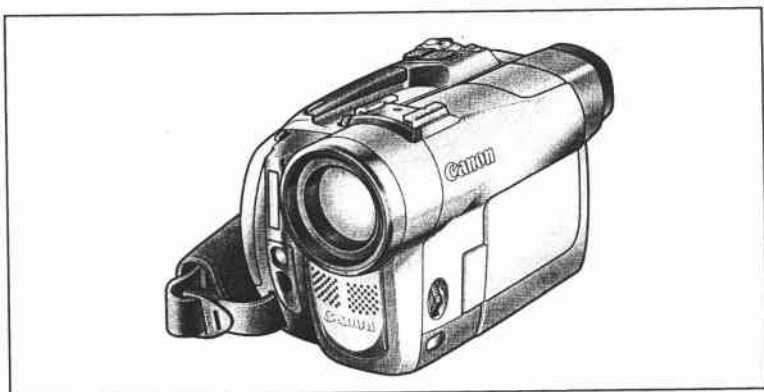

Mini **DV** Digital Video Cassette

BUBBLE JET
DIRECT

DIRECT
PRINT

PictBridge

Please read also the following instruction manual.

- **Digital Video Software**



Introduction

Basic Functions

Advanced Functions

Editing

Using a Memory Card

Direct Printing

Transferring Images

Additional Information

PAL

1

Important Usage Instructions

WARNING!



TO REDUCE THE RISK OF ELECTRIC SHOCK, DO NOT REMOVE COVER (OR BACK). NO USER SERVICEABLE PARTS INSIDE. REFER SERVICING TO QUALIFIED SERVICE PERSONNEL.

WARNING!



TO REDUCE THE RISK OF FIRE OR ELECTRIC SHOCK, DO NOT EXPOSE THIS PRODUCT TO RAIN OR MOISTURE.

CAUTION:

TO REDUCE THE RISK OF ELECTRIC SHOCK AND TO REDUCE ANNOYING INTERFERENCE, USE THE RECOMMENDED ACCESSORIES ONLY.

CAUTION:



DISCONNECT THE MAINS PLUG FROM THE SUPPLY SOCKET WHEN NOT IN USE.

CA-570 identification plate is located on the bottom.

Using this Manual

Thank you for purchasing the Canon MVX350i/MVX330i/MVX300. Please read this manual carefully before you use the camcorder and retain it for future reference. Change the display language before you begin (□ 76).

Symbols and References Used in This Manual

-  : Precautions related to the camcorder operation.
-  : Additional topics that complement the basic operating procedures.
- □ : Reference page number.
- Capital letters are used to refer to buttons on the camcorder or the wireless controller.
- [] are used to refer to menu items displayed on the screen.
- "Screen" refers to the LCD and the viewfinder screen.
- Please note that the illustrations mainly refer to the MVX350i.

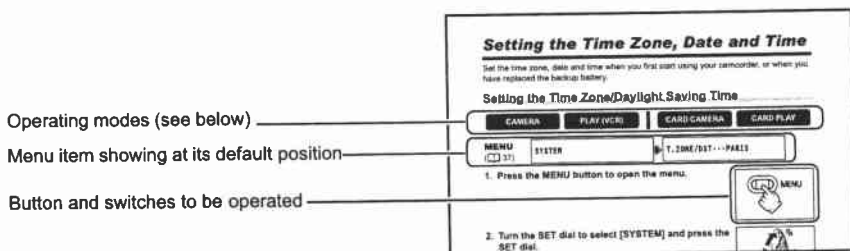

About the Operating Modes

The operating modes are determined by the position of the POWER switch and the TAPE/CARD switch.

Operating Mode	POWER Switch	TAPE/CARD Switch
CAMERA	CAMERA	 (TAPE)
PLAY (VCR)	PLAY (VCR)	 (TAPE)
CARD CAMERA	CAMERA	 (CARD)
CARD PLAY	PLAY (VCR)	 (CARD)

CAMERA : Function can be used in this mode.

CAMERA : Function cannot be used in this mode.

Trademark Acknowledgments

- **MiniDV** is a trademark.
- **SD** is a trademark.
- Windows® is a registered trademark of Microsoft Corporation in the United States and/or other countries.
- Macintosh and Mac OS are trademarks of Apple Computer, Inc., registered in the United States and other countries.
- Other names and products not mentioned above may be registered trademarks or trademarks of their respective companies.

Table of contents

Introduction

Using this Manual	3
Checking Supplied Accessories	6
Components Guide	7

Basic Functions

Preparations

Preparing the Power Supply	11
Loading/Unloading a Cassette	14
Installing the Backup Battery	15
Preparing the Camcorder	16
Using the Wireless Controller	18
Adjusting the LCD Screen	19
Setting the Time Zone, Date and Time	20

Recording

Recording Movies on a Tape	23
Zooming	28
Tips for Making Better Videos	30

Playback

Playing Back a Tape	31
Adjusting the Volume	33
Playing Back on a TV Screen	34

Advanced Functions

Menus and Settings	37
--------------------------	----

Recording

Using the Recording Programs	45
Using the Night Modes	48
Skin Detail Function	50
Adjusting Exposure Manually	51
Adjusting the Focus Manually	52
Setting the White Balance	54
Setting the Shutter Speed	56
Using the Self-Timer	58
Changing the Recording Mode (SP/LP)	59
Audio Recording	60
Using Digital Effects	62
Widescreen TV Recording (16:9)	68

Playback

Magnifying the Image	69
Displaying the Data Code	70
End Search	72
Returning to a Pre-marked Position	73
Date Search	74

Other Functions

Customizing the Camcorder	75
Changing the Display Language	76
Other Camcorder Settings	77

Editing

Recording to a VCR or Digital Video Device	79
MVX350i/MVX330i Recording from Analog Video Devices (VCR, TV or Camcorder).....	81
MVX350i/MVX330i Recording from Digital Video Devices (DV Dubbing).....	82
MVX350i/MVX330i Converting Analog Signals into Digital Signals (Analog-Digital Converter)	84
Audio Dubbing	86
Transferring Video Recordings to a Computer (IEEE1394).....	89

Using a Memory Card

Inserting and Removing a Memory Card	90
Selecting the Image Quality/Size.....	91
File Numbers	93
Recording Still Images on a Memory Card	94
MVX350i/MVX330i Using the Flash	98
Reviewing a Still Image Right after Recording	100
Recording Motion JPEG Movies on a Memory Card	101
Selecting the Focusing Point.....	104
Selecting the Drive Mode	105
Recording Panoramic Images (Stitch Assist Mode)	107
Playing Back a Memory Card	109
Protecting Images.....	111
Erasing Images.....	112
Combining Images (Card Mix).....	113
Formatting a Memory Card.....	117
Creating a Start-up Image	118

Direct Printing

Printing Still Images	119
Selecting the Print Settings	123
Trimming Settings.....	128
Printing with Print Order Settings	129











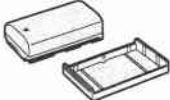

Transferring Images

Transferring Memory Card Images to a Computer	131
Direct Transfer <u>Windows OS only</u>	132
Selecting Images for Transfer (Transfer Order).....	135

Additional Information

About the NETWORK Mode (DV Messenger Version2).....	136
Screen Displays.....	137
List of Messages.....	140
Maintenance/Others	144
Troubleshooting	150
System Diagram (Availability differs from area to area)	154
Optional Accessories.....	155
Specifications.....	157
Index.....	159

Checking Supplied Accessories

<p>CA-570 Compact Power Adapter (incl. power cord)</p> 	<p>NB-2LH Battery Pack</p> 	<p>Lithium Button Battery CR1616</p> 	<p>WL-D85 Wireless Controller</p> 
<p>Lithium Button Battery CR2025 for Wireless Controller</p> 	<p>Lens Cap and Lens Cap Cord</p> 	<p>SS-900 Shoulder Strap</p> 	<p>STV-250N Stereo Video Cable</p> 
<p>PC-A10 SCART Adapter*</p> 	<p>IFC-300PCU USB Cable</p> 	<p>SDC-8M SD Memory Card</p> 	<p>DIGITAL VIDEO SOLUTION DISK For Windows For Macintosh</p> 
<p>MVX350i WA-34 Wide Attachment</p> 			

*Europe only.

Components Guide

MVX350i/MVX330i/MVX300

E

Introduction

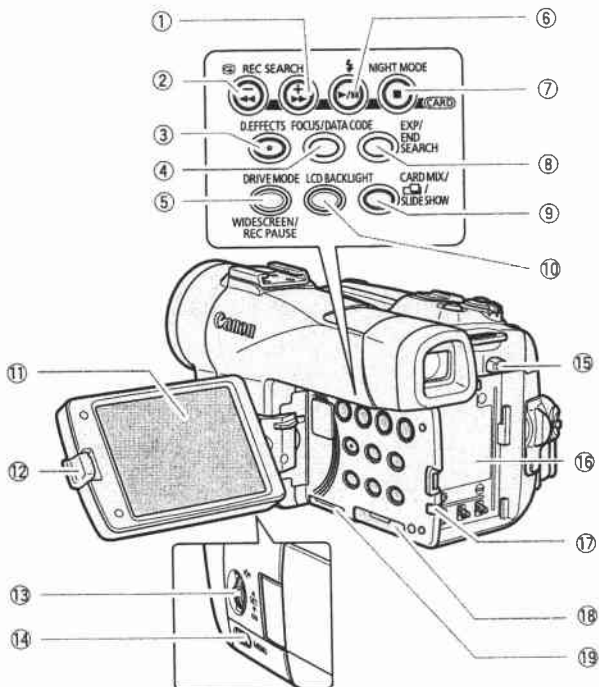

- | | |
|---|---|
| <p>① REC SEARCH + button (□ 27) /
▶▶ (fast forward) button (□ 32) /
CARD + button (□ 109)</p> | <p>⑧ EXP button (□ 51) /
END SEARCH button (□ 72)</p> |
| <p>② REC SEARCH - button (□ 27) /
◀ (record review) button (□ 27) /
◀◀ (rewind) button (□ 31) /
CARD - button (□ 109)</p> | <p>⑨ CARD MIX button (□ 113) /
□ (stitch assist) button (□ 107) /
SLIDE SHOW button (□ 110)</p> |
| <p>③ D.EFFECTS button (□ 62)</p> | <p>⑩ LCD BACKLIGHT button (□ 19)</p> |
| <p>④ FOCUS button (□ 52) /
DATA CODE button (□ 70)</p> | <p>⑪ LCD screen (□ 19)</p> |
| <p>⑤ DRIVE MODE button (□ 105) /
WIDESCREEN button (□ 68) /
REC PAUSE button* (□ 81)</p> | <p>⑫ OPEN button (□ 23)</p> |
| <p>⑥ ⚡ (flash) button* (□ 98) /
▶/ (play/pause) button (□ 31)</p> | <p>⑬ SET dial (□ 37)</p> |
| <p>⑦ NIGHT MODE button (□ 48) /
■ (stop) button (□ 31)</p> | <p>⑭ MENU button (□ 37)</p> |
| | <p>⑮ BATTERY RELEASE button (□ 11)</p> |
| | <p>⑯ Battery attachment unit (□ 11) /
Serial number</p> |
| | <p>⑰ CHARGE indicator (□ 11) /
Card access indicator (□ 94)</p> |
| | <p>⑱ Memory card slot (□ 90)</p> |
| | <p>⑲ Backup battery compartment (□ 15)</p> |

* MVX350i/MVX330i only.

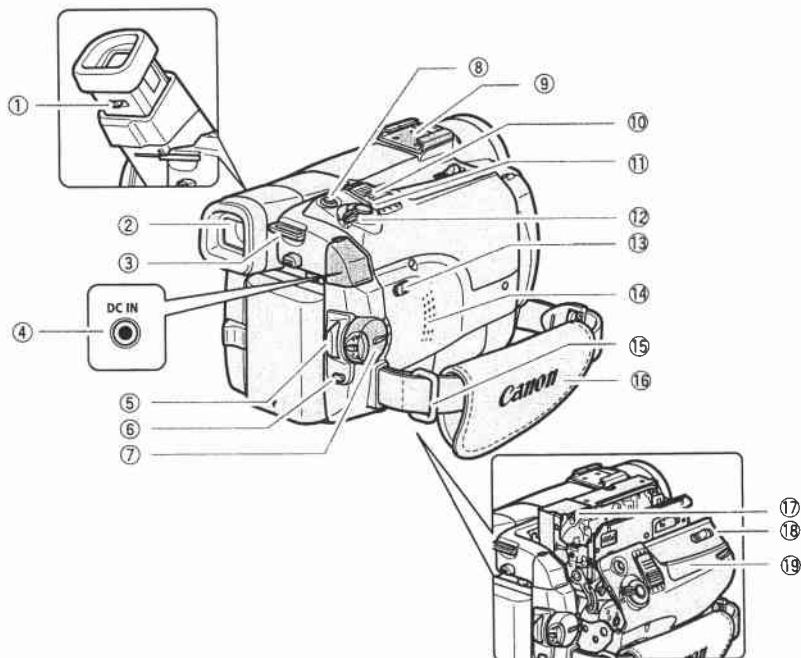

① Dioptic adjustment lever (□ 16)

② Viewfinder (□ 16)



③ Strap mount (□ 17)

④ DC IN terminal (□ 11)

⑤ Start/stop button (□ 23, 101)

⑥ UNLOCK button (□ 136)

⑦ Power switch (□ 3, 136)

⑧   (print/share) button (□ 120, 132)

⑨ Accessory shoe (□ 61)

⑩ Zoom lever (□ 28)

⑪ PHOTO button (□ 94)

⑫ TAPE/CARD switch (□ 3)

 Using a tape

 Using a memory card

⑬ Program selector (□ 45)

 Easy recording

 Program AE

⑭ Speaker (□ 33)

⑮ Strap mount (□ 17)

⑯ Grip belt (□ 16)

⑰ Cassette compartment (□ 14)

⑱ OPEN/EJECT  switch (□ 14)

⑲ Cassette compartment cover (□ 14)

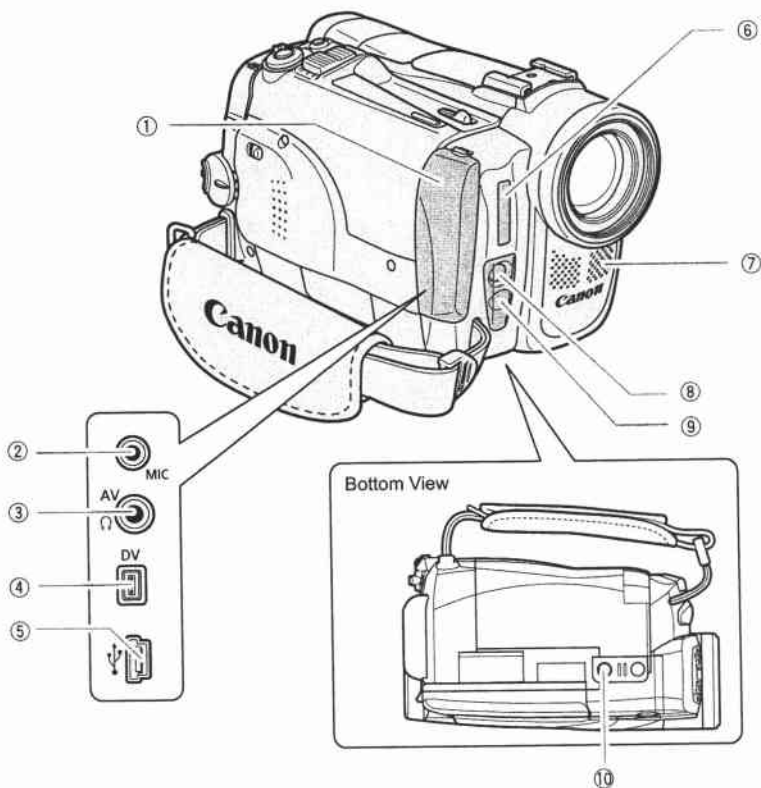

① Terminal cover

② MIC terminal* (□ 61)

③ AV terminal (□ 34) /
Ω (phones) terminal (□ 33, 60)

④ DV terminal (□ 79, 89)

⑤ USB terminal (□ 119, 131)

⑥ Flash* (□ 98)

⑦ Stereo microphone

⑧ **MVX350i** Mini video light
(assist lamp) (□ 48)

MVX330i Assist lamp (□ 48)

⑨ Remote sensor (□ 18)

⑩ Tripod socket (□ 30)

* MVX350i/MVX330i only.

Wireless Controller WL-D85

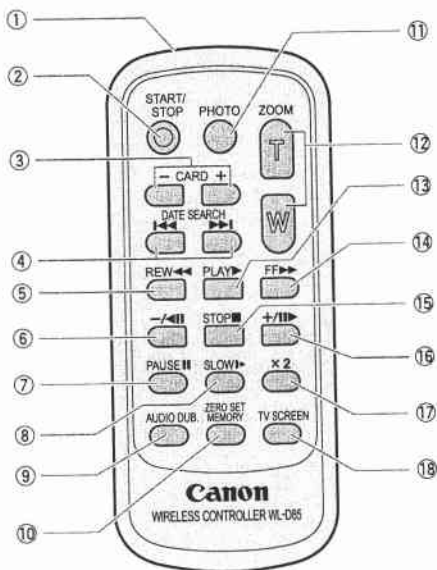

- ① Transmitter
- ② START/STOP button (☐ 23, 101)
- ③ CARD -/+ buttons (☐ 109)
- ④ DATE SEARCH ◀◀/▶▶ buttons (☐ 74)
- ⑤ REW ◀◀ button (☐ 31)
- ⑥ -/|| button (☐ 32)
- ⑦ PAUSE || button (☐ 32)
- ⑧ SLOW ▶▶ button (☐ 32)
- ⑨ AUDIO DUB. button (☐ 86)

- ⑩ ZERO SET MEMORY button (☐ 73)
- ⑪ PHOTO button (☐ 94)
- ⑫ Zoom buttons (☐ 28)
- ⑬ PLAY ▶ button (☐ 31)
- ⑭ FF ▶▶ button (☐ 32)
- ⑮ STOP ■ button (☐ 31)
- ⑯ +/||▶ button (☐ 32)
- ⑰ x 2 button (☐ 32)
- ⑱ TV SCREEN button (☐ 137)

Preparing the Power Supply

Attaching the Battery Pack

1. Turn the POWER switch to OFF.
2. Move the viewfinder upward.
3. Attach the battery pack to the camcorder.
 - Remove the terminal cover of the battery pack.
 - Press lightly and slide it in the direction of the arrow until it clicks.

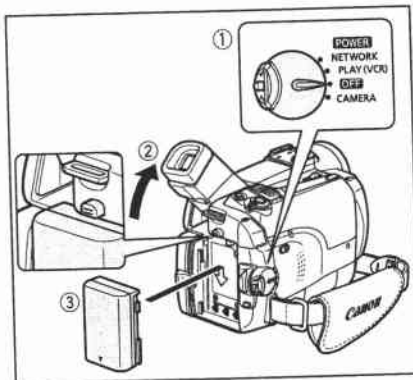

Charging the Battery Pack

1. Connect the power cord to the adapter.
2. Plug the power cord into a power outlet.
3. Connect the power adapter to the camcorder's DC IN terminal.

The CHARGE indicator starts flashing. It glows steadily when charging is complete.
4. When charging is complete, disconnect the power adapter from the camcorder. Unplug the power cord from the power outlet and disconnect it from the adapter.
5. Remove the battery pack after use.

Press the BATTERY RELEASE button to remove the battery.

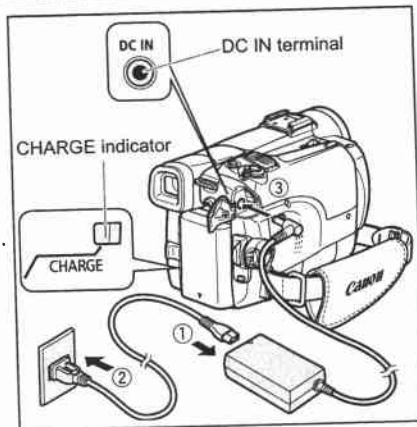

Using a Household Power Source

Connect to a household power source to use the camcorder without worrying about the battery power. You can keep the battery pack attached; the battery power will not be consumed.

1. Turn the **POWER** switch to **OFF**.
2. Connect the power cord to the power adapter.
3. Plug the power cord into a power outlet.
4. Connect the power adapter to the camcorder's DC IN terminal.

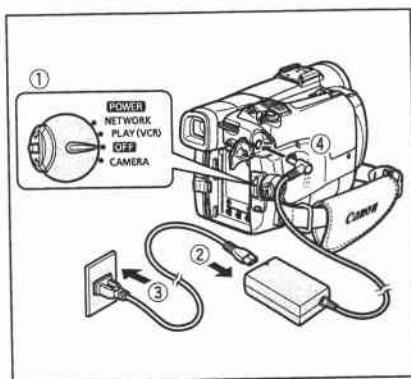

- Turn off the camcorder before connecting or disconnecting the power adapter.
- If the adapter is used close to a TV, it may cause picture interference. Move the adapter away from the TV or the antenna cable.
- Do not connect any products that are not expressly recommended to the camcorder's DC IN terminal or to the power adapter.
- You may hear some noise from the power adapter during use. This is not a malfunction.
- Do not disconnect and reconnect the power cord while charging a battery pack. Charging may stop. The battery pack may not be charged correctly even if the CHARGE indicator glows steady. The battery pack may also not be charged correctly when a power outage occurs during charging. Remove the battery pack and attach it back to the camcorder.



- When the power adapter or battery pack is defective, the CHARGE indicator flashes rapidly (at about 2 flashes/second) and charging stops.
- The CHARGE indicator informs you about the charge status.
 - 0-50%: Flashes once every second
 - More than 50%: Flashes twice every second
 - 100%: Glows steadily

○ Charging, Recording and Playback Times

Below times are approximate and vary according to the charging, recording or playback conditions.

		NB-2LH	NB-2L	BP-2L12	BP-2L14
Charging Time		135 min.	120 min.	210 min.	240 min.
Max. Recording Time					
Viewfinder		120 min.	100 min.	205 min.	250 min.
LCD	Normal	95 min.	75 min.	165 min.	205 min.
	Bright	85 min.	70 min.	140 min.	180 min.
Typical Recording Time*					
Viewfinder		70 min.	55 min.	120 min.	150 min.
LCD	Normal	55 min.	45 min.	95 min.	120 min.
	Bright	50 min.	40 min.	85 min.	105 min.
Playback Time		110 min.	90 min.	185 min.	230 min.

* Approximate times for recording with repeated operations such as start/stop, zooming, power on/off. Actual time may be shorter.

- We recommend charging the battery pack in temperatures between 10 °C and 30 °C (50°F and 86°F). Outside the temperature range of 0 °C to 40 °C (32°F to 104°F), the CHARGE indicator flashes rapidly and charging stops.
- A lithium ion battery pack can be charged at any charge state. Unlike conventional battery packs, you do not need to completely use or discharge it before charging.
- We recommend that you prepare battery packs 2 to 3 times longer than you think you might need.
- To conserve battery power, turn off the camcorder instead of leaving it in record pause mode.

Loading/Unloading a Cassette

Use only videocassettes marked with the **Hi-Fi** logo.

1. Slide the **OPEN/EJECT** switch and open the cassette compartment cover.

The cassette compartment opens automatically.

2. Load/unload the cassette.

- Load the cassette with the window facing the grip belt.
- Unload the cassette by pulling it straight out.

3. Press the **PUSH** mark on the cassette compartment until it clicks.

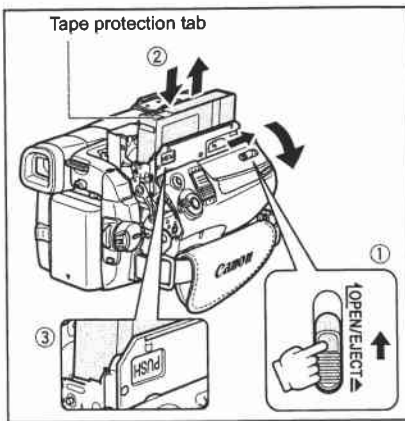

4. Wait for the cassette compartment to retract automatically and close the cassette compartment cover.

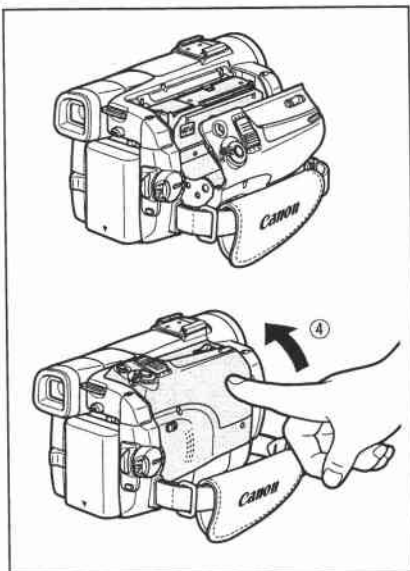

Do not interfere with the cassette compartment while it is opening or closing automatically, or attempt to close the cover before the cassette compartment has fully retracted.

Be careful not to get your fingers caught in the cassette compartment cover.



If the camcorder is connected to a power source, cassettes can be loaded/unloaded even if the **POWER** switch is set to **OFF**.

Installing the Backup Battery

The backup battery (lithium button battery CR1616) allows the camcorder to retain date, time (□ 20) and other camcorder settings while the power source is disconnected. Connect a power source to the camcorder when replacing the backup battery to retain the settings.

1. Press the OPEN button to open the LCD panel.
2. Pull out the battery holder.
3. Place the lithium battery with the + side facing downward into the battery holder.

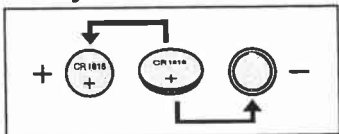

4. Insert the battery holder.
5. Close the LCD panel.

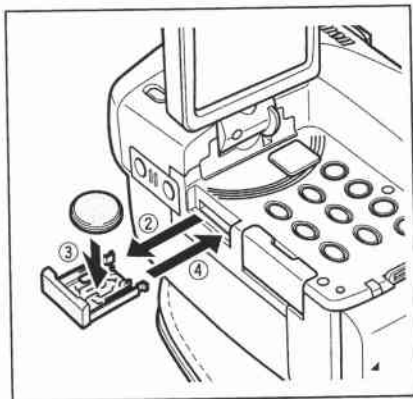
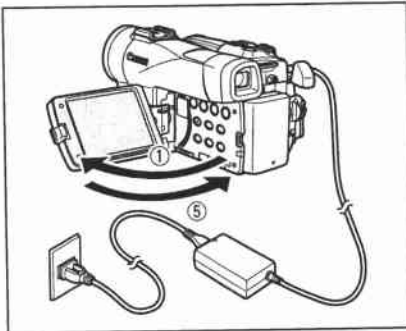

The backup battery has a life span of about a year. “” flashes in red to inform you that it needs to be replaced.

Preparing the Camcorder

Adjusting the Viewfinder (Dioptric Adjustment)

1. Turn on the camcorder and keep the LCD panel closed.
2. Pull out the viewfinder.
3. Adjust the dioptric adjustment lever.
4. Push the viewfinder back in.

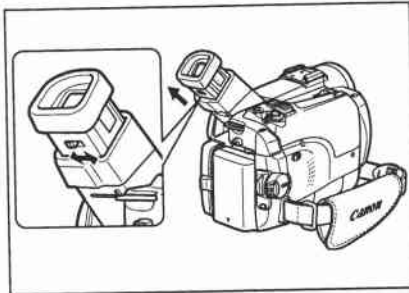

Attaching the Lens Cap

1. Attach the cord to the lens cap.
2. Pass the grip belt through the loop on the cord.

Press the buttons on the lens cap when attaching/removing it. Hook the lens cap on the grip belt while you are recording, and place it over the lens when you have finished.

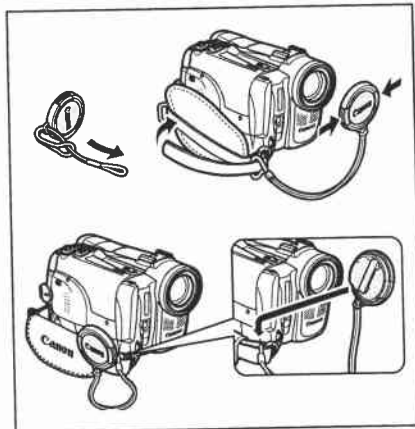

Fastening the Grip Belt

Hold the camcorder with your right hand and adjust the belt with your left.

Adjust the grip belt so that you can reach the zoom lever with your index finger, and the start/stop button with your thumb.

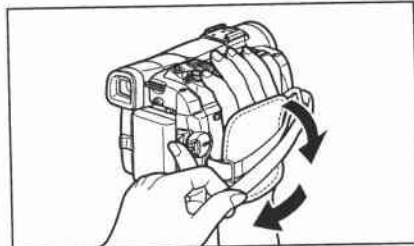

Attaching the Shoulder Strap

Pass the ends through the strap mount and adjust the length of the strap.

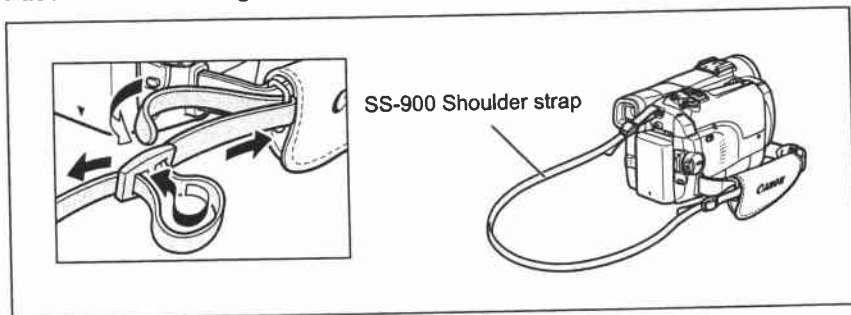

MVX350: Mounting the Wide Attachment

The WA-34 Wide Attachment gives you a wide perspective for indoor shots or panoramic views (0.7x). The wide attachment is for use at maximum wide-angle.

Screw the wide attachment fully into the lens filter thread.

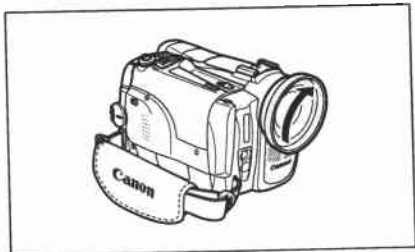

- Do not look directly at the sun or other strong light sources through the wide attachment. It could damage your eyesight.
- If you zoom to telephoto, the picture will not be in focus.
- The wide attachment may obstruct the remote sensor (the range of the wireless controller narrows), or may cause a shadow to appear on the picture when recording with the assist lamp.
- Filters cannot be used with the wide attachment.
- If dust accumulates on the wide attachment or on the camcorder lens, clean both lenses gently with a blower brush.
- Do not touch the lens to avoid smudges and fingerprints.
- Do not store the wide attachment in a humid place as it may mold.

Using the Wireless Controller

Point it at the camcorder's remote sensor when you press the buttons.

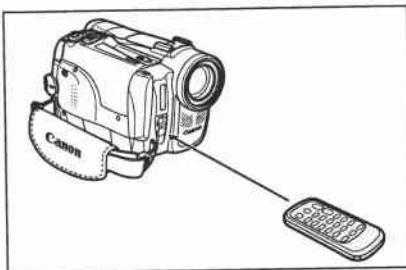

Inserting the Battery

The wireless controller operates with a lithium button battery CR2025.

1. Press the tab in the direction of the arrow and pull out the battery holder.
2. Place the lithium button battery with the + side facing up.
3. Insert the battery holder.

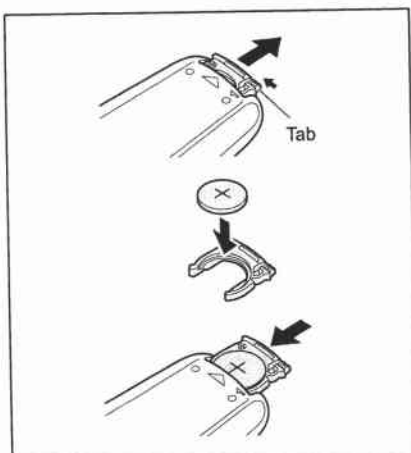

- The wireless controller may not work properly when the remote sensor is subjected to strong light sources or direct sunlight.
- If the wireless controller does not work, check if the remote sensor is set to [OFF] (□ 77).
- When the camcorder cannot be operated with the wireless controller, or when it can only be operated in very close range, replace the battery.

Adjusting the LCD Screen

Rotating the LCD Screen

Press the **OPEN** button and open the LCD panel **90 degrees**.

- You can rotate the panel downward by 90 degrees.
- You can rotate the panel by 180 degrees toward the lens.

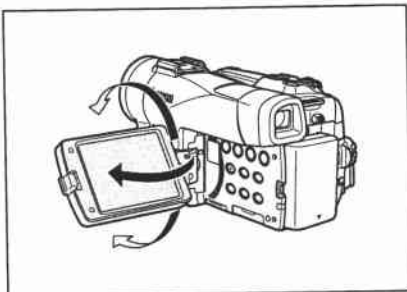

LCD Backlight

You can switch the brightness of the LCD screen between normal and bright by pressing the **LCD BACKLIGHT** button. This is useful for outdoor recordings.

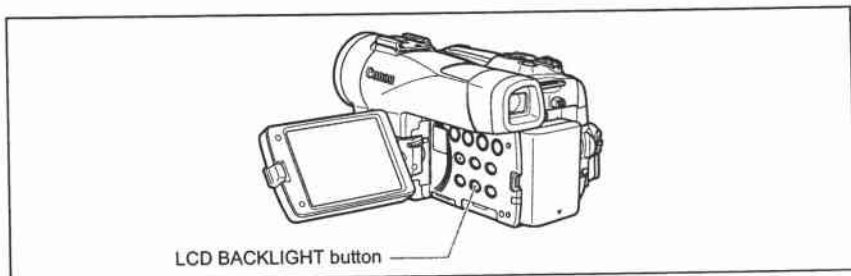

Press the **LCD BACKLIGHT** button.



- This setting does not affect the brightness of the recording or the viewfinder screen.
- When using a battery pack, the camcorder retains the setting even if you change the position of the **POWER** switch.
- The battery usage time shortens when the LCD screen is set brighter (□ 13).

Setting the Time Zone, Date and Time

Set the time zone, date and time when you first start using your camcorder, or when you have replaced the backup battery.

Setting the Time Zone/Daylight Saving Time

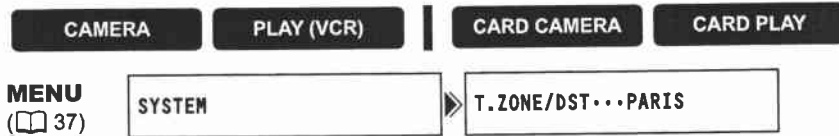

1. Press the MENU button to open the menu.

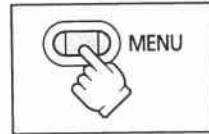

2. Turn the SET dial to select [SYSTEM] and press the SET dial.
3. Turn the SET dial to select [T.ZONE/DST] and press the SET dial.

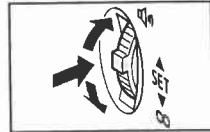

The time zone setting appears (see table on the next page). The default setting is Paris.

4. Turn the SET dial to select the setting option that represents your time zone and press the SET dial.

To adjust for daylight saving time, select the time zone with the * next to the area.

Setting the Date and Time

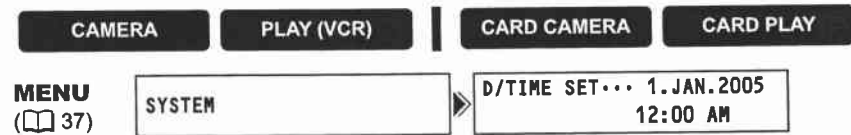

5. Turn the SET dial to select [D/TIME SET] and press the SET dial.

The year display starts to flash.

6. Turn the SET dial to select the year, and press the SET dial.

- The next part of the display starts flashing.
- Set the month, day, hours and minutes in the same way.

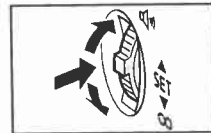

7. Press the MENU button to close the menu and to start the clock.

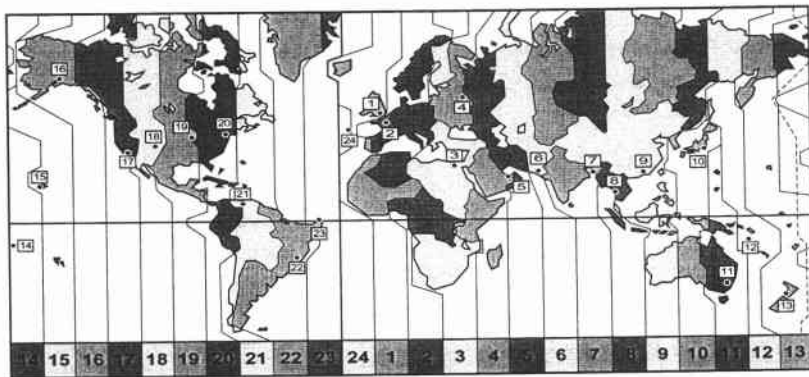
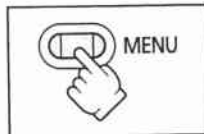

No.	Time zone	No.	Time zone
1	LONDON	13	WELLGTN (Wellington)
2	PARIS	14	SAMOA
3	CAIRO	15	HONOLU. (Honolulu)
4	MOSCOW	16	ANCHOR. (Anchorage)
5	DUBAI	17	L.A. (Los Angeles)
6	KARACHI	18	DENVER
7	DACCA	19	CHICAGO
8	BANGKOK	20	N.Y. (New York)
9	H. KONG (Hong Kong)	21	CARACAS
10	TOKYO	22	RIO (Rio de Janeiro)
11	SYDNEY	23	FERNAN. (Fernando de Noronha)
12	SOLOMON	24	AZORES



Once you have set time zone, date and time, you do not need to reset the clock each time you travel to another time zone. Just set the time zone to the one of your destination, and the camcorder automatically adjusts the clock.

Displaying Date and Time during Recording

You can display the date and time in the lower left corner of the screen.



1. Press the MENU button to open the menu.

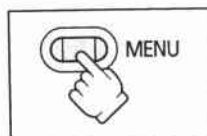

2. Turn the SET dial to select [DISPLAY SETUP/☎] and press the SET dial.

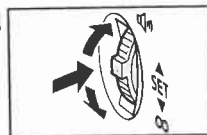

3. Turn the SET dial to select [D/T DISPLAY] and press the SET dial.

4. Turn the SET dial to select [ON].

5. Press the MENU button to close the menu.

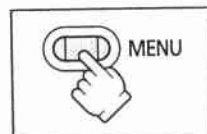

Recording Movies on a Tape

Before You Begin Recording

Make a test recording first to check if the camcorder operates correctly. If necessary, clean the video heads (□ 145).

Recording

1. Remove the lens cap.
2. Set the camcorder to CAMERA mode.

Set the POWER switch to CAMERA and the TAPE/CARD switch to .

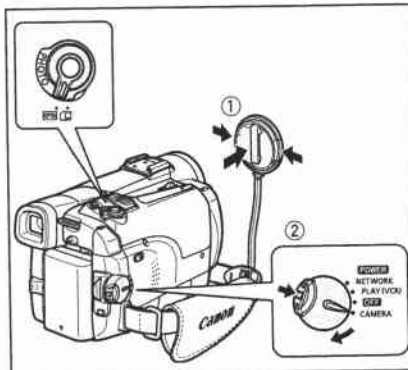

3. Push the OPEN button at the LCD panel and open the LCD panel.
4. Press the start/stop button to begin recording.

Press the start/stop button again to pause recording.

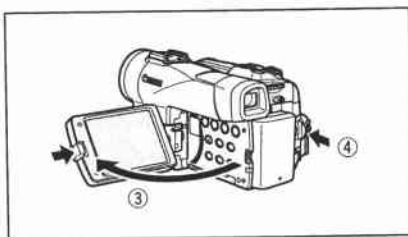

When You Have Finished Recording

1. Turn the POWER switch to OFF.
2. Close the LCD panel.
3. Replace the lens cap.
4. Unload the cassette.
5. Disconnect the power source.





- **About the LCD and viewfinder screen:** The screens are produced with extremely high-precision manufacturing techniques, with more than 99.99% of the pixels operating to specification. Less than 0.01% of the pixels may occasionally misfire or appear as black or green dots. This has no effect on the recorded image and does not constitute a malfunction.
- **The camcorder will shut off after 5 minutes when left in record pause mode to protect tape and video heads. "⚠️ AUTO POWER OFF" appears 20 seconds before shutoff. To continue recording, turn the POWER switch to OFF and then back to CAMERA.**
- Wait until the tape counter stops completely before you start recording.
- When you do not remove the cassette, you can record the next scene without producing any noise or blank sections between the recordings even if you turn the camcorder off.
- Bright light may make it difficult to use the LCD screen. In such case, use the viewfinder instead.
- When recording near loud sounds (such as fireworks, drums or concerts), sound may become distorted or may be recorded not in the actual sound level. This is not a malfunction.

Allowing the Subject to Monitor the LCD Screen

You can rotate the LCD panel so that the screen faces in the same direction as the lens. The viewfinder switches on allowing you to use the viewfinder while the subject can monitor the screen.

The image appears mirror reversed (LCD MIRROR ON). However, you can choose to display the image as it is being recorded (LCD MIRROR OFF).

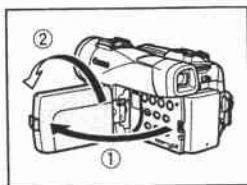

MENU
(37)

DISPLAY SETUP/

LCD MIRROR...ON

1. Press the MENU button to open the menu.



2. Turn the SET dial to select [DISPLAY SETUP/] and press the SET dial.
3. Turn the SET dial to select [LCD MIRROR] and press the SET dial.
4. Turn the SET dial to select [OFF].
5. Press the MENU button to close the menu.

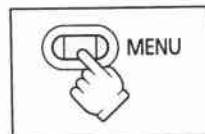
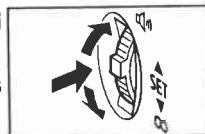

When [LCD MIRROR] is set to [ON], only tape or card operation and self-timer displays appear on the LCD screen (all displays appear on the viewfinder screen).

Screen Displays during Recording

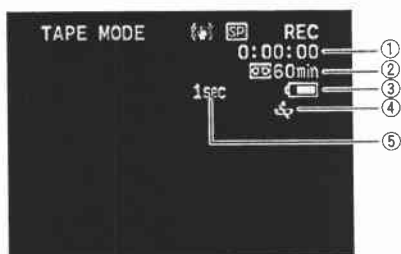

① Time Code

Indicates the recording time in hours, minutes and seconds.

② Remaining tape

Indicates the remaining time of the tape in minutes. "END" moves during recording. "END" flashes when the tape reaches the end.

- When the time left is less than 15 seconds, the remaining tape time may not appear.
- Depending on the type of the tape, the indication may not be displayed correctly.

③ Remaining battery charge

The battery symbol indicates the charge status of the battery pack.



- "⚡" starts flashing in red when the battery pack is empty.
- When you attach an empty battery pack, the power may turn off without displaying "⚡".
- The actual battery charge may not be indicated accurately depending on the condition under which battery pack and camcorder are used.

④ When "⚡" flashes

"⚡" flashes in red when the lithium button battery is not installed, or when it needs replacing.

⑤ Recording reminder

The camcorder counts from 1 to 10 seconds when you start recording. This is helpful to avoid scenes that are too short.

Reviewing and Searching when Recording

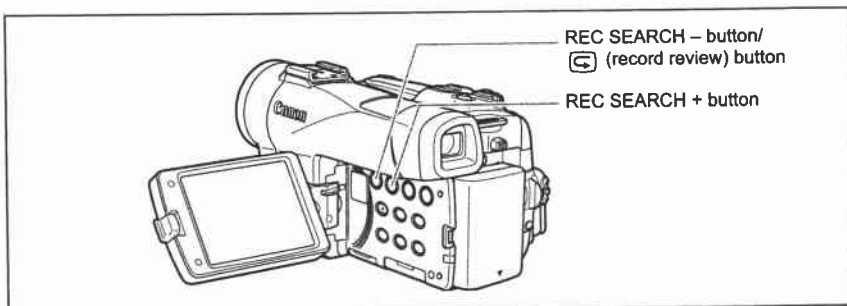

Record Review



In record pause mode, this function allows you to review the last few seconds of your recording to check if it has been recorded properly.

Press and release the ⏮ (record review) button.

The camcorder rewinds the tape, plays back the last few seconds, and returns to record pause mode.



Record Search



In record pause mode, this function allows you to play back the tape (forward or reverse) to locate the point where you wish to begin recording.

Press and hold the REC SEARCH + button (forward) or - button (reverse).

- Release the button at the point you wish to begin recording.
- The camcorder returns to record pause mode.



Zooming

The camcorder is equipped with optical zoom and digital zoom.

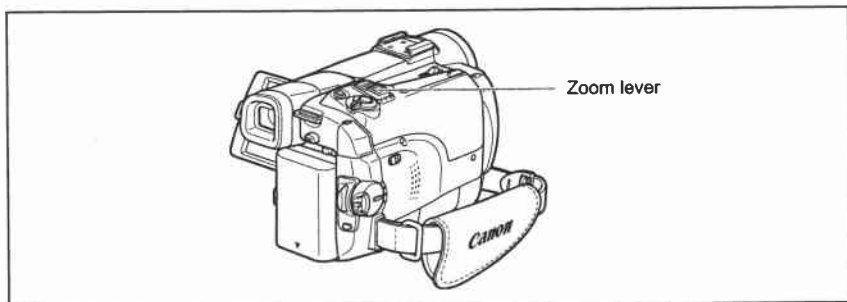
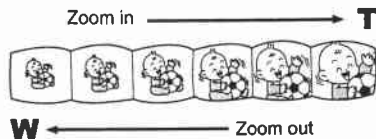

Optical Zoom

MVX350i	MVX330i / MVX300
20x optical zoom	18x optical zoom

CAMERA

PLAY (VCR)

CARD CAMERA

CARD PLAY

Move the zoom lever toward **W** to zoom out (wide-angle). Move it toward **T** to zoom in (telephoto).

Press the zoom lever slightly for a slow zoom. Press harder for a faster zoom.

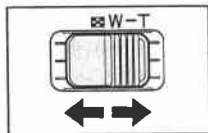

- You can also use the **T** and **W** buttons on the wireless controller. However, you cannot control the zoom speed.
- The zoom speed is slightly faster in record pause mode.
- Keep at least 1 m (3.3 ft.) to the subject. At wide-angle, you can focus on a subject as close as 1 cm (0.39 in.).

Digital Zoom

When the digital zoom is activated, the camcorder automatically switches between optical and digital zoom. With digital zoom, image resolution becomes lower the more you zoom in.

MVX350i	MVX330i / MVX300
80x/400x digital zoom (80x in CARD CAMERA mode)	72x/360x digital zoom (72x in CARD CAMERA mode)



MENU
(37)



1. Press the **MENU** button to open the menu.
2. Turn the **SET** dial to select [**CAMERA SETUP**] and press the **SET** dial.
3. Turn the **SET** dial to select [**D.ZOOM**] and press the **SET** dial.
4. Turn the **SET** dial to select a setting option.
5. Press the **MENU** button to close the menu.

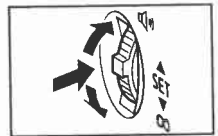
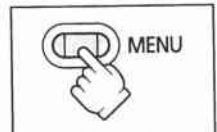

- Digital zoom cannot be used in the night modes.
- Digital zoom cannot be used in Stitch Assist mode, or when the multi-image screen is selected.
- A zoom indicator appears for 4 seconds. It extends in light blue when the digital zoom is set to 80x (MVX350i) or 72x (MVX330i/MVX300), and extends further in dark blue when set to 400x (MVX350i) or 360x (MVX330i/MVX300).

Tips for Making Better Videos

Holding the Camcorder

For maximum stability, grip the camcorder in your right hand and keep your right elbow pressed against your body. If necessary, support the camcorder with your left hand. Be careful that your fingers do not touch the microphone or lens.



For More Stability

Lean against a wall



Lie on your elbow



Put the camcorder on a table



Kneel on one knee



Use a tripod



Lighting

When recording outdoors, we recommend recording with the sun at your back.



- When using a tripod, do not leave the viewfinder exposed to direct sunlight as it may melt (due to concentration of the light by the lens).

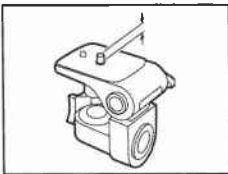

Do not use tripods with fastening screws longer than 5.5 mm (0.2 in.) as it may damage the camcorder.



Playing Back a Tape

If the playback picture is distorted, clean the video heads using a Canon Head Cleaning Cassette or a commercially available digital video head-cleaning cassette (□ 145).

1. Set the camcorder to PLAY (VCR) mode.

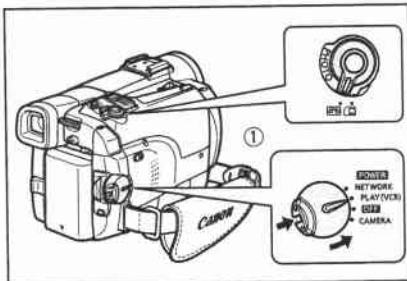
Set the POWER switch to PLAY (VCR) and the TAPE/CARD switch to .



2. Open the LCD panel.
3. Press the  button to rewind the tape.
4. Press the  button to begin playback.
5. Press the  button to stop playback.

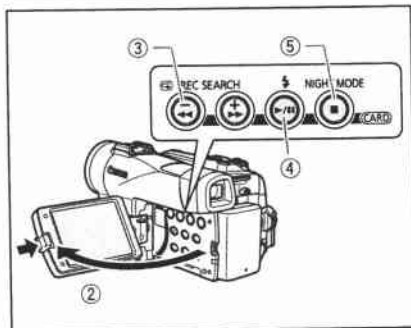

○ To use the viewfinder, close the LCD panel.

○ About the screen display: During playback, the time code gives the hours, minutes, seconds and frames. The remaining tape time may not appear when the time left is less than 15 seconds.

Special Playback Modes

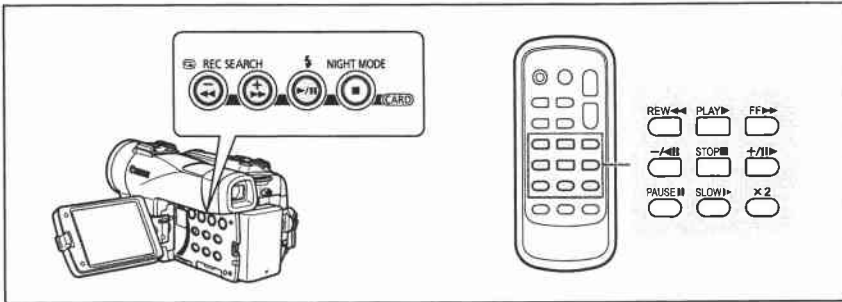

▶/II (Playback Pause)

To pause playback, press the ▶/II button during normal playback.

▶▶ (Fast Forward Playback) / ◀◀ (Rewind Playback)

Plays back the tape at 11.5 times normal speed (forward or reverse). Press and hold the button during normal playback or fast forward.

-/◀II (Reverse Playback)

Press the button on the wireless controller during normal playback. Press the ▶ (play) button to return to normal playback.

+/II▶ (Frame Advance) / -/◀II (Frame Reverse)

Plays back frame-by-frame. Press the button on the wireless controller repeatedly during playback pause. Press and hold it to play back continuous frame advance/frame reverse.

SLOW I▶ (Slow Forward)/(Slow Reverse)

Plays back at about 1/3 normal speed. Press the button on the wireless controller during normal or reverse playback. Press the ▶ (play) button to return to normal playback.

x2 (Forward x2 Playback)/(Reverse x2 Playback)

Plays back at 2 times normal speed. Press the button on the wireless controller during normal or reverse playback. Press the ▶ (play) button to return to normal playback.



- There is no sound during special playback.
- The picture may become distorted during some special playback modes.
- The camcorder stops the tape automatically after 5 minutes in playback pause mode to protect tape and video heads.

Adjusting the Volume

When you use the LCD screen for playback, the camcorder plays back the sound via built-in speaker. The speaker does not sound when you close the LCD panel. Use headphones when using the viewfinder.

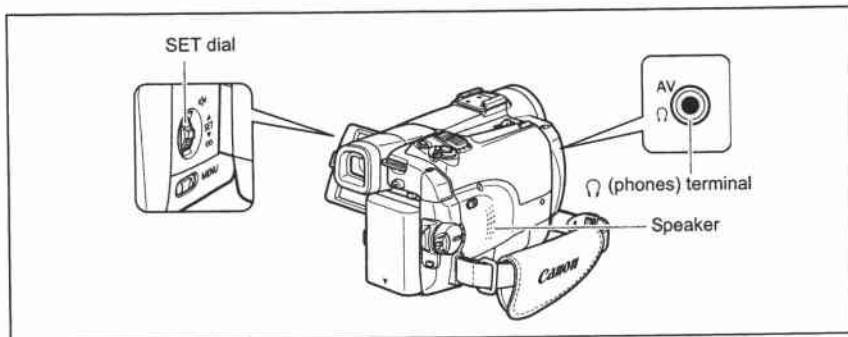

When Using Headphones

The headphones terminal also serves as AV terminal. Headphones can only be used when "Ω" is displayed on the screen. If not, change the setting following the procedure below.

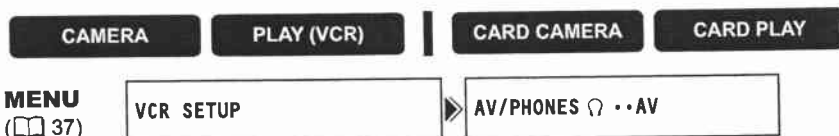

Open the menu and select [VCR SETUP]. Select [AV/PHONES Ω], set it to [PHONES Ω] and close the menu.



- The speaker does not sound when "Ω" is displayed.
- Do not connect headphones unless "Ω" is displayed as it produces noise.

Adjusting the Volume



Turn the SET dial up to increase the volume, and down to lower the volume.

- A volume bar appears for 2 seconds.
- You can turn off the volume completely by turning the SET dial down until [OFF] appears. Turn the SET dial up to increase the volume again.

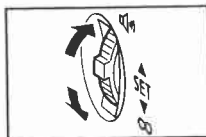

Playing Back on a TV Screen

The AV terminal also serves as headphones terminal. When "Ω" is displayed on the screen, change the setting following the procedure below.

CAMERA

PLAY (VCR)

CARD CAMERA

CARD PLAY

MENU
(37)

VCR SETUP

AV/PHONES Ω ··AV

Open the menu and select [VCR SETUP]. Select [AV/PHONES Ω], set it to [AV] and close the menu.

TVs with SCART Terminal

Refer also to the TV or VCR instruction manual.

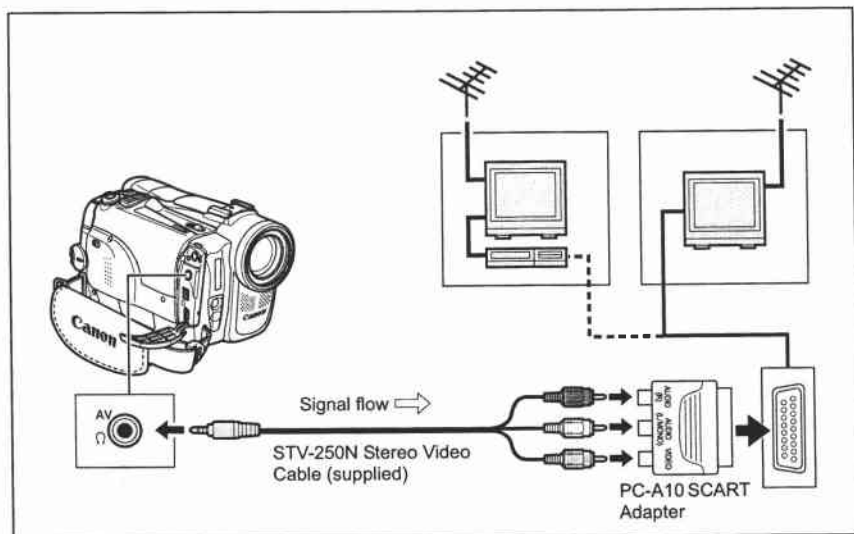

1. Turn off all devices before starting the connections.
2. Connect the PC-A10 SCART Adapter to the TV or VCR's terminals.
3. Connect the STV-250N Stereo Video Cable to the camcorder's AV terminal and the audio terminals on the SCART Adapter.
Connect the white plug to the white AUDIO terminal L (left), and the red plug to the red AUDIO terminal R (right) and the yellow plug to the yellow VIDEO terminal.
4. If connecting to a TV, set the input selector to VIDEO. If connecting to a VCR, set the input selector to LINE.

TVs with Audio/Video Terminals

Refer also to the TV or VCR instruction manual.

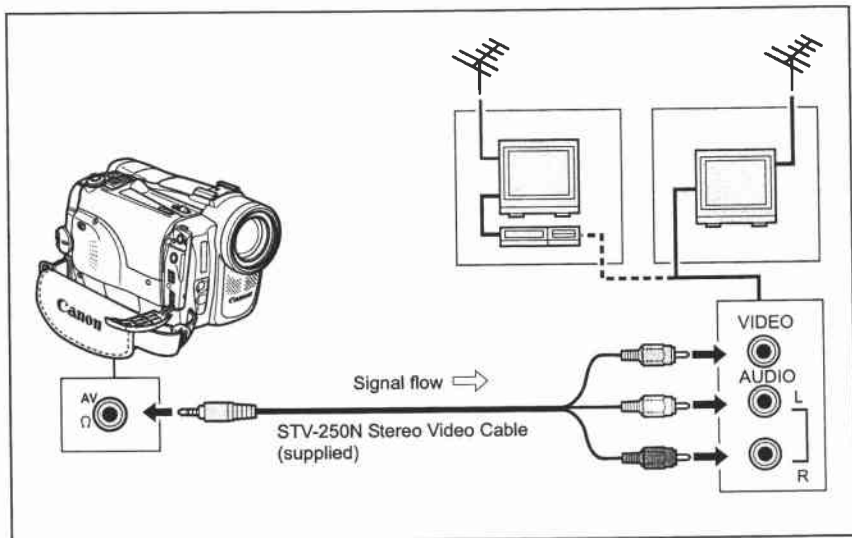

1. Turn off all devices before starting the connections.
2. Connect the STV-250N Stereo Video Cable to the camcorder's AV terminal and the audio/video terminals on the TV/VCR.
Connect the white plug to the white audio terminal L (left), the red plug to the red audio terminal R (right) and the yellow plug to the yellow video terminal VIDEO.
3. If connecting to a TV, set the input selector to VIDEO. If connecting to a VCR, set the input selector to LINE.



We recommend powering the camcorder from a household power source.

E

Basic Functions
Playback

Selecting the Audio Output Channel

You can select the output channels when playing back a tape with audio recorded on two channels.



1. Press the MENU button to open the menu.

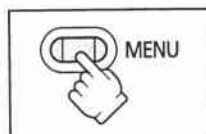

2. Turn the SET dial to select [AUDIO SETUP] and press the SET dial.

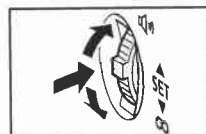

3. Turn the SET dial to select [OUTPUT CH] and press the SET dial.

4. Turn the SET dial to select a setting option.

- L/R: Stereo: L+R channels, Bilingual: Main+Sub.
- L/L: Stereo: L channel, Bilingual: Main.
- R/R: Stereo: R channel, Bilingual: Sub.

5. Press the MENU button to close the menu.

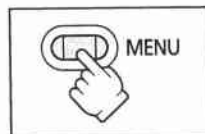

The setting resets to the L/R setting when you turn the camcorder off.

Menus and Settings

Many of the camcorder's advanced functions are selected from menus that appear on the screen.

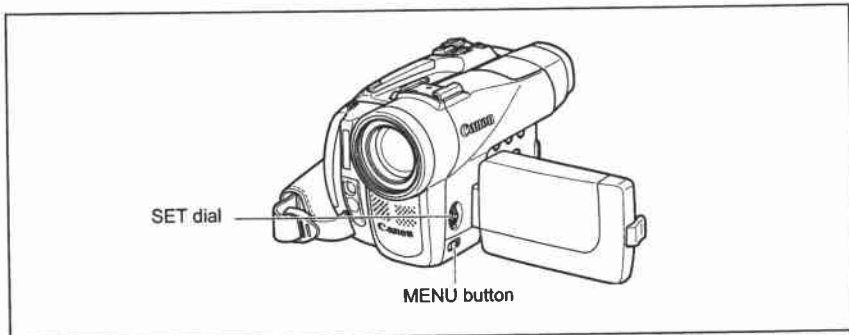

Selecting Menus and Settings

1. Press the **MENU** button to open the menu.

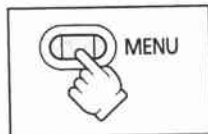

2. Turn the **SET** dial to select a submenu and press the **SET** dial.

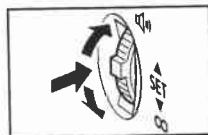

3. Turn the **SET** dial to select a menu item and press the **SET** dial.

4. Turn the **SET** dial to select a setting option.

5. Press the **MENU** button to close the menu.

When setting the white balance, shutter speed or language, press the **SET** dial first before pressing the **MENU** button.

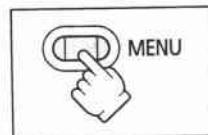

- Pressing the **MENU** button at any time closes the menu.
- Items that are not available appear in purple.

Menu and Default Settings

Default settings are shown in boldface.

CAMERA MENU

CAMERA

PLAY (VCR)

CARD CAMERA

CARD PLAY

Submenu	Menu Item	Setting Options		
D.EFFECT SETUP	➔ CARD MIX		113	
	D.E.SELECT	OFF, FADER, EFFECT, MULTI-S	62	
	FADER TYPE	FADE-T, WIPE, CORNER, JUMP, FLIP, PUZZLE, ZIGZAG, BEAM, TIDE		
	EFFECT TYPE	ART, BLACK&WHITE, SEPIA, MOSAIC, BALL, CUBE, WAVE, COLOR MASK, MIRROR		
	M.S.SPEED	MANUAL, FAST, MODERATE , SLOW		
	M.S.SPLIT	4, 9, 16		
CAMERA SETUP	SHUTTER	AUTO , 1/50, 1/120, 1/250, 1/500, 1/1000, 1/2000	56	
	A.SL SHUTTER	ON, OFF	57	
	D.ZOOM	MVX350i	MVX330i/MVX300	29
		OFF, 80X, 400X	OFF, 72X, 360X	
	IMG STAB (📷)	ON, OFF	78	
	WHITE BAL.	AUTO , SET 📷, INDOOR 🌸, OUTDOOR 🌟	54	
	AF AST LAMP	AUTO , OFF	99	
	SELF TIMER	ON 🕒, OFF	58	
	NIGHT MODE *	📷 NIGHT, 📷 NIGHT+, 📷 S.NIGHT	48	
	SKIN DETAIL	SOFT, NORMAL	50	
STILL I.REC	OFF, <input type="checkbox"/> FINE, <input type="checkbox"/> NORMAL	96		
VCR SETUP	REC MODE	SP, LP	59	
	AV/PHONES 🔊	AV, PHONES 🔊	60	
AUDIO SETUP	WIND SCREEN	AUTO , OFF	61	
	AUDIO MODE	16bit, 12bit	60	
	🔊 VOLUME		60	

* MVX350i/MVX330i only.

Submenu	Menu Item	Setting Options	□
DISPLAY SETUP/ ☺	BRIGHTNESS		77
	LCD MIRROR	ON, OFF	25
	TV SCREEN	ON, OFF	137
	D/T DISPLAY	ON, OFF	22
	LANGUAGE ☺	See list of languages.	76
	DATE FORMAT		76
	DEMO MODE	ON, OFF	78
SYSTEM	WL.REMOTE	ON, OFF (☺)	77
	BEEP	ON, OFF	77
	T.ZONE/DST	See list of time zones.	20
	D/TIME SET		20
MY CAMERA	S-UP SOUND	OFF, DEFAULT, MY SOUND	75
	SHTR SOUND		
	OPER.SOUND		
	SELF-T SOUND		





PLAY (VCR) MENU

CAMERA



PLAY (VCR)

CARD CAMERA

CARD PLAY

Submenu	Menu Item	Setting Options	
D.EFFECT SETUP	D.E.SELECT	OFF, FADER, EFFECT, MULTI-S	62
	FADER TYPE	FADE-T, WIPE, CORNER, JUMP, FLIP, PUZZLE, ZIGZAG, BEAM, TIDE	
	EFFECT TYPE	ART, BLACK&WHITE, SEPIA, MOSAIC, BALL, CUBE, WAVE, COLOR MASK, MIRROR	
	M.S.SPEED	MANUAL, FAST, MODERATE, SLOW	
	M.S.SPLIT	4, 9, 16	
VCR SETUP	REC MODE*	SP, LP	59
	AV/PHONES 	AV, PHONES 	34
	AV → DV*	ON, OFF	85
AUDIO SETUP	OUTPUT CH	L/R, L/L, R/R	36
	AUDIO DUB*	AUDIO IN, MIC. IN	86
	WIND SCREEN	AUTO, OFF	61
	AUDIO MODE*	16bit, 12bit	60
	12bit AUDIO	STEREO1, STEREO2, MIX/FIXED, MIX/VARI.	88
	MIX BALANCE		88
CARD SETUP	IMG QUALITY	SUPER FINE, FINE, NORMAL	91
	MOVIE SIZE	320x240, 160x120	92
	FILE NOS.	RESET, CONTINUOUS	93
DISPLAY SETUP/ 	BRIGHTNESS		77
	TV SCREEN	ON, OFF	137
	DISPLAYS	ON, OFF <PLAYBK>	137
	6SEC.DATE	ON, OFF	71
	DATA CODE	DATE/TIME, CAMERA DATA, CAM.& D/T	70
	D/TIME SEL.	DATE, TIME, DATE & TIME	70
	LANGUAGE 	See list of languages.	76
	DATE FORMAT		76

* MVX350i/MVX330i only.

Submenu	Menu Item	Setting Options	
SYSTEM	WL.REMOTE	ON, OFF 	77
	BEEP	ON, OFF	77
	T.ZONE/DST	See list of time zones.	20
	D/TIME SET		20
MY CAMERA	S-UP SOUND	OFF, DEFAULT, MY SOUND	75
	SHTR SOUND		
	OPER.SOUND		
	SELF-T SOUND		

CARD CAMERA MENU

CAMERA

PLAY (VCR)

CARD CAMERA

CARD PLAY

Submenu	Menu Item	Setting Options		
D.EFFECT SETUP	EFFECT	OFF, BLACK&WHITE	65	
CAMERA SETUP	SHUTTER	AUTO, 1/50, 1/120, 1/250	56	
	A.SL SHUTTER	ON, OFF	57	
	D.ZOOM	MVX350i	MVX330i/MVX300	29
		OFF, 80X	OFF, 72X	
	WHITE BAL.	AUTO, SET \odot , INDOOR \odot , OUTDOOR \odot	54	
	AF AST LAMP	AUTO, OFF	99	
	FOCUS PRI.	ON, OFF	104	
	SELF TIMER	ON \odot , OFF	58	
	ND	AUTO, OFF	95	
	NIGHT MODE*	\odot NIGHT, \odot NIGHT+, \odot S.NIGHT	48	
	SKIN DETAIL	SOFT, NORMAL	50	
	REVIEW	OFF, 2sec, 4sec, 6sec, 8sec, 10sec	100	
CARD SETUP	IMG QUALITY	SUPER FINE, FINE, NORMAL	91	
	IMAGE SIZE	1280x960, 640x480	91	
	MOVIE SIZE	320x240, 160x120	92	
	FILE NOS.	RESET, CONTINUOUS	93	
VCR SETUP	AV/PHONES \odot	AV, PHONES \odot	60	
AUDIO SETUP	WIND SCREEN	AUTO, OFF	61	
	\odot VOLUME		60	
DISPLAY SETUP/ \odot	BRIGHTNESS		77	
	LCD MIRROR	ON, OFF	25	
	TV SCREEN	ON, OFF	137	
	D/T DISPLAY	ON, OFF	22	
	LANGUAGE \odot	See list of languages.	76	
	DATE FORMAT		76	
	DEMO MODE	ON, OFF	78	

*MVX350i/MVX330i only.

Submenu	Menu Item	Setting Options	□
SYSTEM	WL.REMOTE	ON, OFF 	77
	BEEP	ON, OFF	77
	T.ZONE/DST	See list of time zones.	20
	D/TIME SET		20
MY CAMERA	S-UP SOUND	OFF, DEFAULT, MY SOUND	75
	SHTR SOUND		
	OPER.SOUND		
	SELF-T SOUND		

CARD PLAY MENU

CAMERA

PLAY (VCR)

CARD CAMERA

CARD PLAY

Submenu	Menu Item	Setting Options	
CARD OPERATIONS (Single Image Display)	PRINT ORDERS ALL ERASE	NO, YES	130
	TRANS.ORDERS ALL ERASE	NO, YES	135
	IMAGE ERASE	CANCEL, SINGLE, ALL	112
	FORMAT	CANCEL, EXECUTE	117
CARD OPERATIONS (Index Screen)	⇒ PROTECT		111
	⇒ PRINT ORDER		129
	⇒ TRANSFER ORDER		135
VCR SETUP	AV/PHONES ()	AV, PHONES ()	34
DISPLAY SETUP/ 	BRIGHTNESS		77
	TV SCREEN	ON, OFF	137
	DISPLAYS	ON, OFF <PLAYBK>	137
	D/TIME SEL.	DATE, TIME, DATE & TIME	70
	LANGUAGE	See list of languages.	76
	DATE FORMAT		76
SYSTEM	WL.REMOTE	ON, OFF	77
	BEEP	ON, OFF	77
	T.ZONE/DST	See list of time zones.	20
	D/TIME SET		20
MY CAMERA	CREATE START-UP IMAGE		118
	SEL.S-UP IMG	NO IMAGE, CANON LOGO , MY IMAGE	75
	S-UP SOUND	OFF, DEFAULT , MY SOUND	75
	SHTR SOUND		
	OPER.SOUND		
	SELF-T SOUND		
⇒ PRINT	Appears when connecting a printer with direct print function.		130

Using the Recording Programs

Easy Recording Program

The camcorder adjusts focus, exposure and other settings automatically, allowing you to just point and shoot.



Program AE Modes

Auto

The camcorder adjusts focus, exposure and other settings automatically. However, you have the option of adjusting the settings manually.



Sports

Use this mode to record sports scenes (such as tennis or golf) or moving objects (such as roller coasters).



Portrait

Use this mode to give accent to your subject by blurring the background or foreground. The blur effect increases the more you zoom to telephoto.



Spotlight

Use this mode to record spotlight scenes or fireworks.



Sand & Snow

Use this mode in bright places such as a sunny beach or ski resort. It prevents the subject from being underexposed.



Low Light

Use this mode to record in dimly lit places.



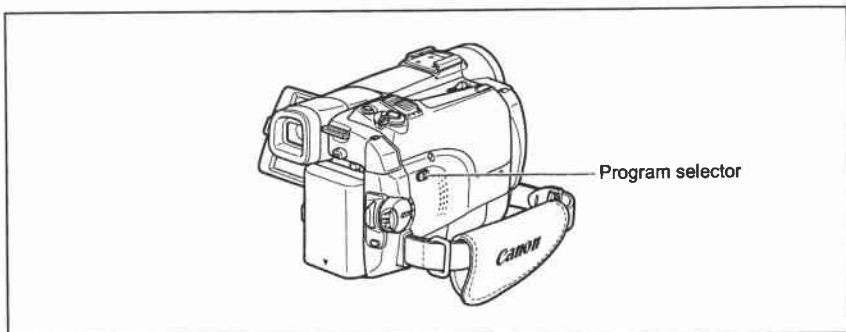

Availability of Functions in Each Mode:

Recording Program							
Image Stabilizer	×*				○		
Focus	× (A)				○		
White Balance	× (A)				○		
Shutter Speed	× (A)	○			× (A)		
Exposure Lock	×				○		
Digital Effects	×				○		
Card Mix	×				○		

○: Available ×: Not available A: Auto setting
 Shaded area: Can be used only in CAMERA mode.
 * The setting is automatically set to ON.

Selecting the Easy Recording Program



Set the program selector to EASY.

" EASY" appears.

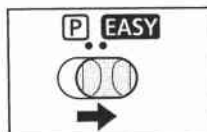

Selecting the Program AE Mode

CAMERA

PLAY (VCR)

CARD CAMERA

CARD PLAY

1. Set the program selector to **P**.

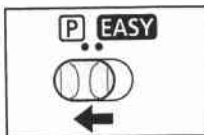

2. Press the SET dial.

A list of the program AE modes appears.

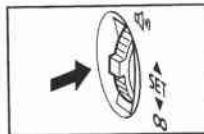

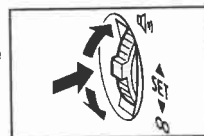

3. Select a mode and press the SET dial.

The symbol of the mode appears on the upper left corner of the screen.



- The setting resets to the Auto mode when you change the position of the program selector.
- Do not change the mode during recording as the brightness of the image may change abruptly.
- Sports/Portrait mode:
 - The picture may not appear smooth when played back.
- Sand & Snow mode:
 - The subject may become overexposed in dark surroundings. Check the image on the screen.
 - The picture may not appear smooth when played back.
- Low Light mode:
 - Moving subjects may leave a trailing afterimage.
 - Picture quality may not be as good as in other modes.
 - The camcorder may have difficulty to focus automatically.

Using the Night Modes

 NIGHT	Allows you to record in dark places where lights cannot be used, without sacrificing color.
MVX350i / MVX330i  NIGHT+	The assist lamp lights up and stays on, allowing you to record in dark places without sacrificing color.
MVX350i / MVX330i  S. NIGHT	Allows you to record in very dark places without sacrificing color. The assist lamp lights up automatically responding to the surrounding brightness.



Night Mode



MVX350i / MVX330i

Night+ Mode
Super Night Mode

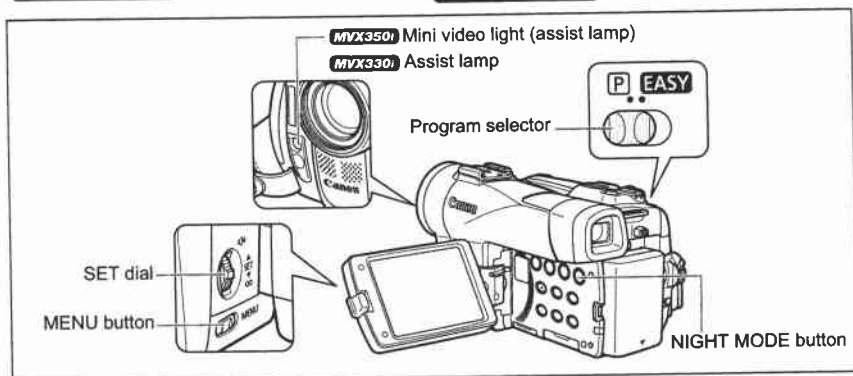

CAMERA

PLAY (VCR)

CARD CAMERA

CARD PLAY

MVX350i / MVX330i

MENU
( 37)

CAMERA SETUP

NIGHT MODE...  NIGHT+

1. Set the program selector to .
2. Open the menu and select [CAMERA SETUP]. Select [NIGHT MODE], select a setting option and close the menu.
3. Press the NIGHT MODE button.
 - The symbol of the selected mode appears on the screen.
 - Pressing the NIGHT MODE button again resets the camcorder to the Auto mode.

MVX300

1. Set the program selector to **[P]**.

2. Press the **NIGHT MODE** button.

- "N" appears.
- Pressing the **NIGHT MODE** button again resets the camcorder to the Auto mode.



MVX350i

- Do not point the mini video light at persons while they are driving.
- Do not look at the mini video light for a long time.
- Do not use the mini video light close to people's eyes.



- Moving subjects may leave a trailing afterimage.
- Picture quality may not be as good as in other modes.
- White points may appear on the screen.
- Autofocus may not work as well as in other modes. In such case, adjust the focus manually.
- Digital zoom and multi-image screen cannot be used while a night mode is activated.
- The program AE mode cannot be changed while a night mode is activated.

Skin Detail Function

When shooting close-ups of people, the camcorder automatically softens details to reduce the appearance of skin imperfections for a more complimentary appearance.



Open the menu and select [CAMERA SETUP]. Select [SKIN DETAIL], set it to [SOFT] and close the menu.



- Skin detail function cannot be used when the program selector is set to EASY.
- [SKIN DETAIL] resets to [NORMAL] when you change the position of the POWER switch or the program selector.
- To obtain the best effect, use this function when recording a person in close-up. Note that areas similar to the skin color may lack in detail.

Adjusting Exposure Manually

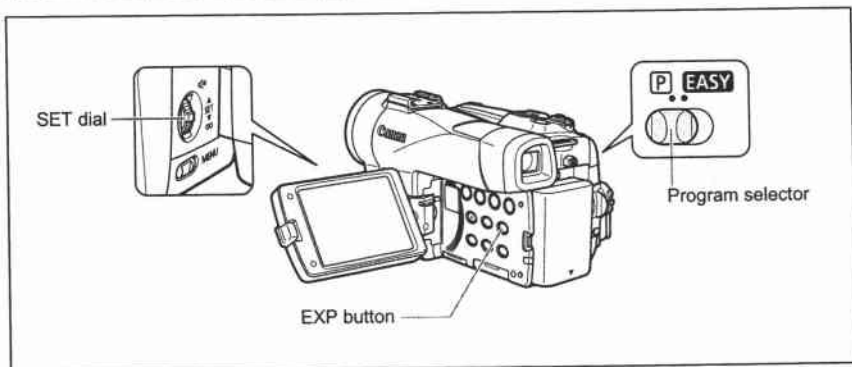

Exposure Lock

You can lock the exposure when recording in situations where the lighting may change suddenly to control the brightness of the image.



1. Set the program selector to **P**.



2. Press the EXP button.

- "E.LOCK ±0" appears on the screen.
- When you operate the zoom during exposure lock, the brightness of the image may change.



Exposure Adjustment

When the exposure is locked, you can adjust it manually to handle difficult lighting conditions. The camcorder's iris can be set to any position from fully closed to fully open.



Turn the SET dial to adjust the brightness of the image.

The adjustment range depends on the brightness at the time you locked the exposure.



Adjusting the Focus Manually

Autofocus may not work well on the following subjects. In such case, focus manually.

Reflective surfaces



Subjects with low contrast or without vertical lines



Fast Moving Subjects



Through dirty or wet windows



Night Scenes

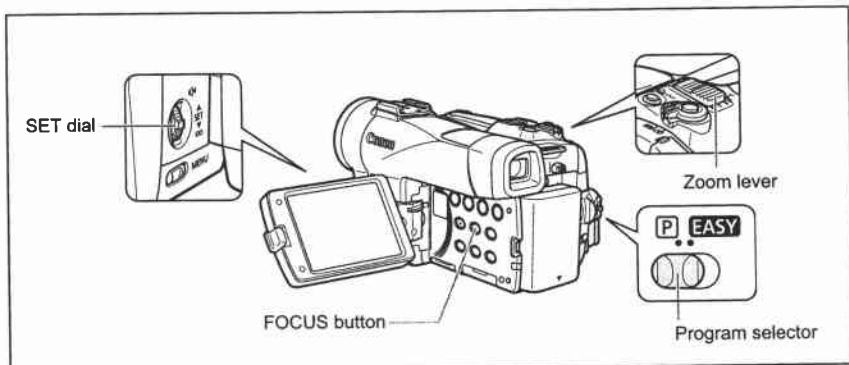

CAMERA

PLAY (VCR)

CARD CAMERA

CARD PLAY

1. Set the program selector to **P**.



2. Adjust the zoom.

When you operate the zoom after adjusting the focus, the subject may not stay in focus. Adjust the zoom before the focus.

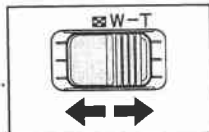

3. Press the FOCUS button.

"MF" appears.

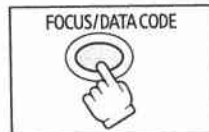

4. Turn the SET dial to adjust the focus.

- Turn the SET dial up or down until the image appears focused.
- Press the FOCUS button to return to autofocus.





- The setting resets to autofocus when you switch the program selector to EASY.
- Readjust the focus when you have turned off the camcorder.

Infinity Focus

Use this function when you wish to focus on faraway subjects such as mountains or fireworks.

Press the FOCUS button more than 2 seconds after step 2 in *Adjusting the Focus Manually*.



"MF ∞" appears.



When you operate the zoom or turn the SET dial, "∞" disappears and the camcorder changes to manual focus.

Setting the White Balance

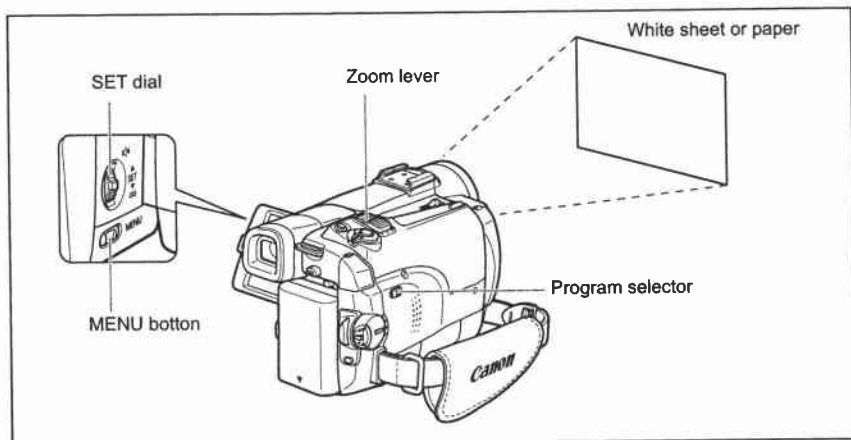

You can use the preset modes to reproduce colors more accurately, or set a custom white balance to obtain the optimal setting.

AUTO	Auto white balance
SET 	Use the custom white balance setting to make white subjects appear white under colored lighting.
INDOOR 	Use this mode for recording under changing lighting condition, video lights or sodium lamps.
OUTDOOR 	Use this mode for recording night scenes, fireworks, sunrise or sunset.



MENU
( 37)



1. Set the program selector to .
2. For custom white balance: Point the camcorder at a white object and zoom in until it fills the whole screen.
Keep the camcorder zoomed at the white object until step 3 is completed.
3. Open the menu and select [CAMERA SETUP]. Select [WHITE BAL.], select a setting option and close the menu.
When you have selected [SET ]: "" flashes and stops flashing when settings is complete.



- Use the auto setting for normal outdoor scenes.
- When the program selector is set to EASY, white balance is preset to [AUTO].
- The camcorder retains the custom white balance setting even if you turn it off. However, it resets to [AUTO] when you change the position of the TAPE/CARD switch.
- When you have set the custom white balance:
 - Depending on the light source, “” may keep flashing. The result will still be better than with the auto setting.
 - Reset the white balance when the lighting condition changes.
 - Turn off the digital zoom.
- Custom white balance may provide better results in the following cases:
 - Changing lighting conditions
 - Close-ups
 - Subjects in a single color (sky, sea or forest)
 - Under mercury lamps or certain types of fluorescent lights

Setting the Shutter Speed

You can adjust the shutter speed manually to make stable shots of fast moving subjects.



1. Set the program selector to **[P]**.
2. Set the program AE mode to the **[A]** (Auto) mode.
3. Open the menu and select **[CAMERA SETUP]**.
4. Select **[SHUTTER]**.
5. Select the shutter speed and press the SET dial.

CAMERA Mode	CARD CAMERA Mode
AUTO	AUTO
1/50	1/50
1/120	1/120
1/250	1/250
1/500	
1/1000	
1/2000	

6. Close the menu.



- If the shutter speed is set to 1/500 or higher in CAMERA mode and you switch to CARD CAMERA mode, it automatically changes to 1/250.
- Do not point the camcorder directly at the sun when the shutter speed is set to 1/1000 or higher.
- The image may flicker when recording with high shutter speeds.
- The setting resets to the auto setting when you switch the program selector to EASY, or change the program AE mode.
- Guidelines for Recording with High Shutter Speeds:
 - Outdoor sports such as golf or tennis: 1/2000
 - Moving objects such as cars or roller coasters: 1/1000, 1/500 or 1/250
 - Indoor sports such as basketball: 1/120

Auto Slow Shutter

In Easy Recording mode and when [SHUTTER] is set to [AUTO] in Auto mode, the camcorder uses shutter speeds down to 1/25 in CAMERA mode and 1/12.5 in CARD CAMERA mode. This allows you to record brightly in places with insufficient lighting. However, you can set the camcorder not to use a slow shutter speed.



* **MX350i/MX330i** Only when the flash mode is set to  (flash off).

MENU
( 37)

CAMERA SETUP

A.SL SHUTTER-ON

Open the menu and select [CAMERA SETUP]. Select [A.SL SHUTTER], set it to [OFF] and close the menu.



- When set to [ON], moving subjects may leave a trailing afterimage.
- The camcorder retains the setting separately in CAMERA and CARD CAMERA mode.
- The setting cannot be changed when exposure is locked.
- If "" (camcorder shake warning) appears in CARD CAMERA mode, stabilize the camcorder, for example, by mounting it on a tripod or placing it on a table.

Using the Self-Timer

The self-timer can be used for recording movies and still images.

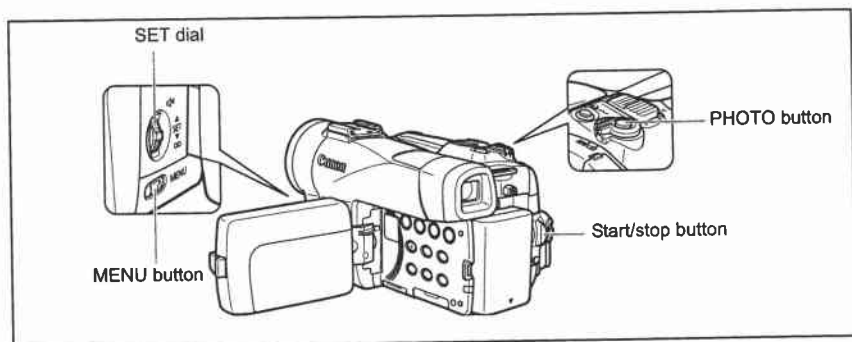

MENU
(37)

CAMERA SETUP

▶ SELF TIMER...OFF

1. Open the menu and select [CAMERA SETUP]. Select [SELF TIMER], set it to [ON] and close the menu.

"" appears.

2. Press the start/stop button.

- The camcorder starts recording after a 10-second countdown (2 seconds when using the wireless controller). The count down appears on the screen.
- To record a still image, press the PHOTO button (94).



- To cancel the self-timer, set [SELF TIMER] to [OFF]. Once the countdown has begun, you can also press the start/stop button (when recording movies) or the PHOTO button (when recording still image) to cancel the self-timer.
- The self-timer will be canceled when you turn off the camcorder.

Changing the Recording Mode (SP/LP)

You can choose between SP (standard play) and LP (long play). LP extends the tape usage by 1.5 times.



* MVX350i/MVX330i only.

MENU
(37)

VCR SETUP

▶ REC MODE.....SP

To change to LP mode, open the menu and select [VCR SETUP]. Select [REC MODE], set it to [LP] and close the menu.



- Tapes recorded in LP mode cannot be used for audio dubbing.
- Depending on the nature and usage condition of the tape, picture and sound recorded in LP mode may be distorted. We recommend using the SP mode for important recordings.



- If you record in both SP and LP modes on the same tape, the playback picture may become distorted and the time code may not be written correctly.
- If you play back a tape that has been recorded in LP mode with another digital device on this camcorder, or vice versa, picture and sound may become distorted.

Audio Recording

Changing the Audio Mode

You can record sound in two audio modes—16-bit and 12-bit. The 12-bit mode records sound on two channels (stereo 1), leaving 2 channels free (stereo 2) for adding new sound later. Select the 16-bit mode for higher sound quality.



* MVX350i/MVX330i only.



Open the menu and select [AUDIO SETUP]. Select [AUDIO MODE], set it to [16bit] and close the menu.

"16bit" appears for approximately 4 seconds.

Using Headphones during Recording

The headphones terminal also serves as AV terminal. Headphones can only be used when "Ω" is displayed on the screen. If not, change the setting following the procedure below.



Open the menu and select [VCR SETUP]. Select [AV/PHONES Ω], set it to [PHONES Ω] and close the menu.

Adjusting the Headphone Volume



Open the menu and select [AUDIO SETUP]. Select [Ω VOLUME], adjust the volume with the SET dial and close the menu.

You can turn off the volume completely by turning the SET dial down until [OFF] appears. Turn the SET dial up to increase the volume again.

Wind Screen

The camcorder reduces wind noise automatically. However, you can turn off the wind screen when recording indoors, or when you want the microphone to be as sensitive as possible.



* **MVX350i/MVX330i** Only when [AUDIO DUB.] is set to [MIC.IN].

MENU
( 37)

AUDIO SETUP

WIND SCREEN •• AUTO

Open the menu and select [AUDIO SETUP]. Select [WIND SCREEN], set it to [OFF] and close the menu.

"WS OFF" appears when you turn the wind screen off.



The wind screen function can only be used with the built-in microphone.

MVX350i/MVX330i Recording with an External Microphone

You can attach a commercially available microphone equipped with an accessory shoe.

Refer also to the instruction manual of the microphone.

1. Attach the microphone to the accessory shoe.
2. When using a commercially available microphone, connect it to the MIC terminal.

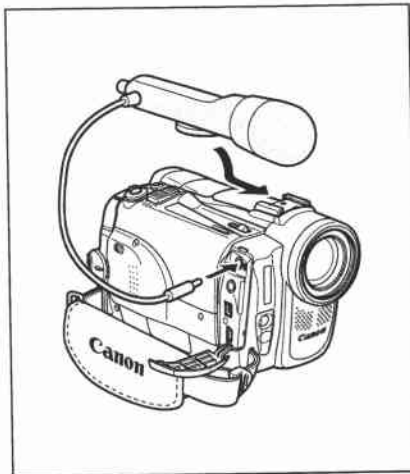

- When recording in silent places, the built-in microphone may pick up the motor noise of the camcorder. In such case, we recommend using an external microphone.
- When using a commercially available microphone:
 - Use a microphone with built-in power supply (condenser microphone). Almost all stereo microphones with a plug diameter of 3.5 mm (0.14 in.) can be connected. The audio level may differ from that of the built-in microphone.
 - Long microphones may appear on the screen.

Using Digital Effects

Faders (☐ 64)

Begin or end scenes with a fade to or from black.

Fade Trigger (FADE-T)



Wipe (WIPE)

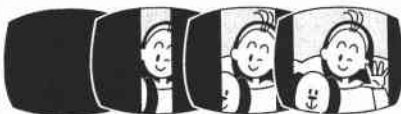

Corner Wipe (CORNER)



Jump (JUMP)



Flip (FLIP)



Puzzle (PUZZLE)

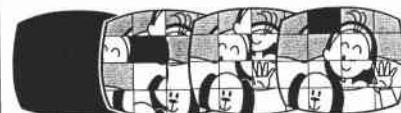

Zigzag (ZIGZAG)



Beam (BEAM)











Tide (TIDE)

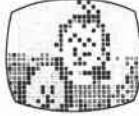

Effects (□ 65)

Add flavor to your recordings.

Art (ART) 	Black and White (BLACK & WHITE) 	Sepia (SEPIA) 
Mosaic (MOSAIC) 	Ball (BALL) 	Cube (CUBE) 
Wave (WAVE) 	Color Mask (COLOR MASK) 	Mirror (MIRROR) 

Multi-Image Screen (□ 66)

Captures moving subjects in 4, 9 or 16 sequences of still images and displays them at one time. Sound will be recorded normally.

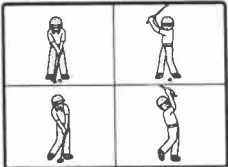
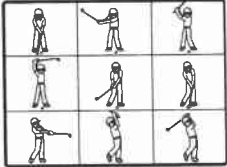
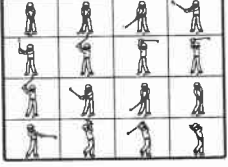
4 Sequences 	9 Sequences 	16 Sequences 
--	--	--

Availability of Digital Effects by Operating Modes:

	CAMERA		PLAY (VCR)	CARD CAMERA	CARD PLAY
	Movies	Still Images			
Faders	○	×	○	×	×
Effects	○	×	○	○*	×
Multi-image screen	○	×	○	×	×

○ : Available × : Not available

* : Black and White only.

Selecting a Fader

In CAMERA mode, set the program selector to .

CAMERA

PLAY (VCR)

CARD CAMERA

CARD PLAY

1. Open the menu and select [D.EFFECT SETUP].
2. Select [D.E.SELECT] and set it to [FADER].
3. Select [FADER TYPE], select a setting option and close the menu.

The name of the selected fader flashes.

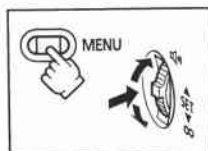

CAMERA mode:

4. **Fade in:** In record pause mode, press the D.EFFECTS button and begin recording by pressing the start/stop button.

Fade out: During recording, press the D.EFFECTS button and pause recording by pressing the start/stop button.

The fader can be activated/deactivated by pressing the D.EFFECTS button.



PLAY (VCR) mode:

4. **Fade in:** In playback pause mode, press the D.EFFECTS button and begin playback by pressing the ►/II button.

Fade out: During playback, press the D.EFFECTS button and pause playback by pressing the ►/II button.

The fader can be activated/deactivated by pressing the D.EFFECTS button.

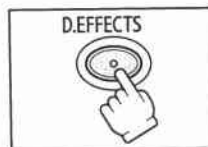

Selecting an Effect

In CAMERA mode, set the program selector to .



1. Open the menu and select [D.EFFECT SETUP].
2. Select [D.E.SELECT] and set it to [EFFECT].
3. Select [EFFECT TYPE], select a setting option and close the menu.

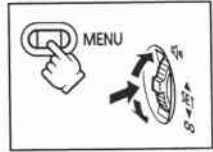

The name of the selected effect flashes.

4. Press the D.EFFECTS button.

- The name of the selected effect stops flashing.
- The effect can be activated/deactivated by pressing the D.EFFECTS button.



Selecting an Effect in CARD CAMERA Mode



1. Open the menu and select [D.EFFECT SETUP].
Select [EFFECT], set it to [BLACK&WHITE] and close the menu.

"BLK&WHT" flashes.

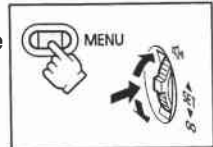

2. Press the D.EFFECTS button.

- "BLK&WHT" stops flashing.
- The effect can be activated/deactivated by pressing the D.EFFECTS button.

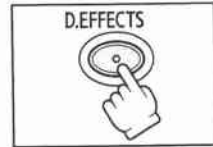

Using the Multi-Image Screen

You can operate the multi-image screen only in the following playback modes:

- When [M.S.SPEED] is set to [MANUAL]: Playback pause, slow forward/reverse playback
 - When [M.S.SPEED] is set to [FAST], [MODERATE] or [SLOW]: Playback pause
- In CAMERA mode, set the program selector to .

CAMERA

PLAY (VCR)

CARD CAMERA

CARD PLAY

1. Open the menu and select [D.EFFECT SETUP].
2. Select [D.E.SELECT] and set it to [MULTI-S].
3. Select [M.S.SPEED] and select the transition speed.

Following transition speeds can be selected: fast (every 4 frames), moderate (every 6 frames*), slow (every 8 frames*).

* In Low Light mode: moderate (every 8 frames), slow (every 12 frames).

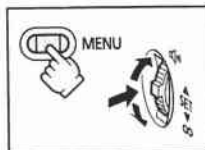

4. Select [M.S.SPLIT], select the number of sequences and close the menu.

"MULTI-S" flashes.

5. Press the D.EFFECTS button.

- MANUAL: Images will be captured each time you press the D.EFFECTS button. The blue frame indicating the next sequence disappears after the last image. Pressing the D.EFFECTS button for more than 1 second cancels the images one after another.

- FAST, MODERATE, SLOW: The set number of images will be captured at the set speed. To cancel the multi-image screen, press the D.EFFECTS button.

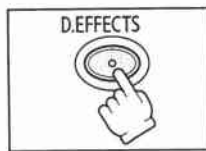

6. Press the start/stop button to begin recording.

The multi-image screen is recorded on the tape.



- Turn off the digital effect when you do not use it.
- The camcorder retains the setting even if you turn it off or change the program AE mode.
- The image quality may be slightly lower with digital effects.
- Digital effects cannot be used in the following cases:
 - When the program selector is set to EASY.
 - During DV dubbing.
- Faders cannot be used when Card Mix is activated.

About the multi-image screen:

- The multi-image screen cannot be used in the following cases:
 - In the night modes.
 - When the widescreen mode is selected.
 - When Card Mix is activated.
- In PLAY (VCR) mode: Pressing any tape operation button (such as play or pause), or performing date search cancels the multi-image screen.

Widescreen TV Recording (16:9)

The camcorder uses the full width of the CCD providing high-resolution 16:9 recording.

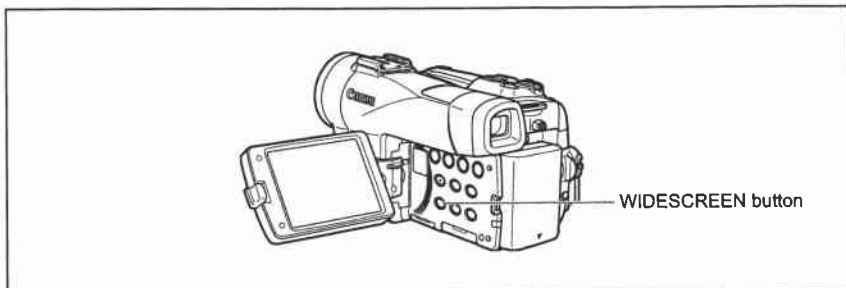

CAMERA

PLAY (VCR)

CARD CAMERA

CARD PLAY

Press the WIDESCREEN button.

- "WIDE" appears.
- The LCD screen switches to the "letterbox" display. The picture on the viewfinder appears horizontally squeezed.

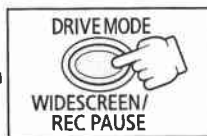

- When you turn off the image stabilizer, you will get a larger horizontal angle of view.
- The multi-image screen cannot be used when the widescreen mode is selected.
- Simultaneous recording on a memory card cannot be used when the widescreen mode is selected.
- If you play back a widescreen recording on a normal TV, the image appears horizontally squeezed.

Magnifying the Image

The playback image can be magnified up to 5 times.

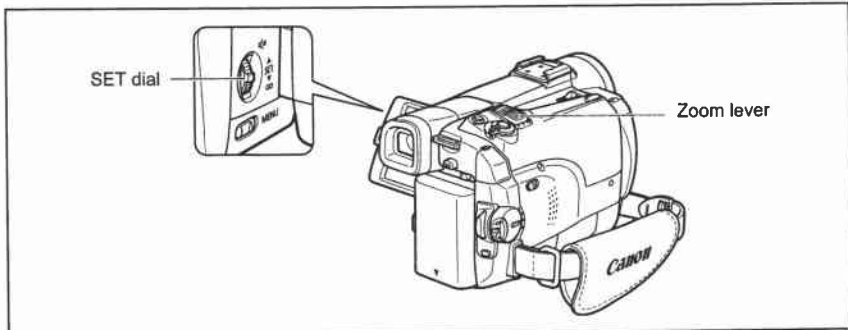

1. Move the zoom lever toward **T**.

- The image is magnified by 2 times.
- A frame appears indicating the position of the magnified area.
- To further enlarge the image, move the zoom lever toward **T**. To shrink the image below 2 times magnification, move the zoom lever toward **W**.

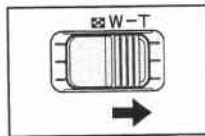

2. Select the magnified area with the SET dial.

- Turn the SET dial to move the image to the right and left, or up and down. Pressing the SET dial switches between the directions.
- To cancel the magnification, move the zoom lever toward **W** until the frame disappears.

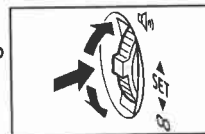

Movies played back from a memory card cannot be magnified.

Displaying the Data Code

The camcorder maintains a data code containing recording date and time and other camera data such as shutter speed and exposure (f-stop). When you play back a tape, you can display the data code and select the data code combination you wish to display.

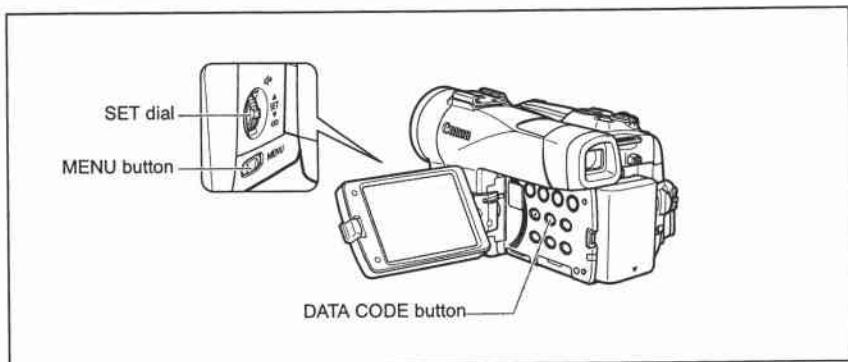

Selecting the Date/Time Display Combination



Open the menu and select [DISPLAY SETUP/☺]. Select [D/TIME SEL.], set it to [DATE] or [TIME] and close the menu.

Selecting the Data Code Display Combination



Open the menu and select [DISPLAY SETUP/☺]. Select [DATA CODE], set it to [CAMERA DATA] or [CAM. & D/T] and close the menu.

Displaying the Data Code



Press the **DATA CODE** button.



- The data code will not display the next time you turn on the camcorder.
- Only date and time appear in **CARD PLAY** mode.

Six-Second Auto Date

Date and time appear for 6 seconds when you begin playback, or to indicate that date or time zone has changed.



MENU
(37)

DISPLAY SETUP/Ⓢ

▶ 6SEC.DATE...OFF

Open the menu and select [**DISPLAY SETUP/Ⓢ**]. Select [**6SEC.DATE**], set it to [**ON**] and close the menu.

End Search

When you have played back a tape, you can use this function to locate the end of the last recorded scene.

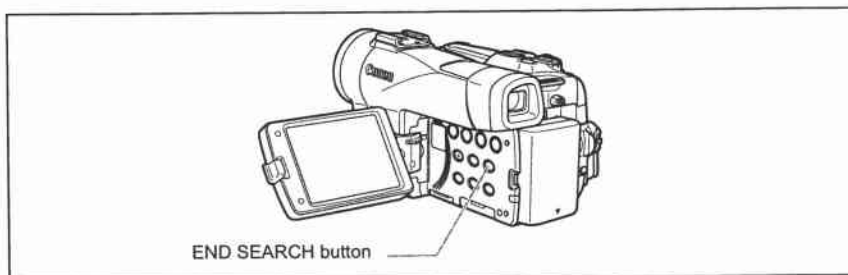

CAMERA

PLAY (VCR)

CARD CAMERA

CARD PLAY

In stop mode, press the END SEARCH button.

- "END SEARCH" appears.
- The camcorder rewinds/fast forwards the tape, plays back the last few seconds of the recording and stops the tape.
- Pressing the button again cancels the search.



- End search cannot be used once you unload the cassette.
- End search may not work properly if a blank section exists on the tape.
- You cannot use end search to locate the editing end of audio dubbing.

Returning to a Pre-marked Position

If you wish to return to a particular scene later, mark the point with the zero set memory and the tape will stop at that point when you rewind/fast forward the tape.

This function is operated with the wireless controller.

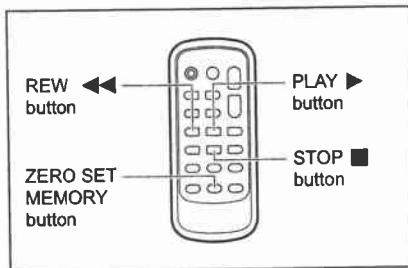

CAMERA

PLAY (VCR)

CHOOSE MENU

LAST PLAY

1. Press the ZERO SET MEMORY button at the point you wish to return to later.

- "0:00:00  appears.
- To cancel, press the ZERO SET MEMORY button again.

2. When you have finished playback, rewind the tape.

- "◀◀RTN" appears.
- The tape stops automatically at "0:00:00".
- The tape counter changes to time code.

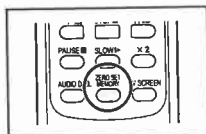

The zero set memory may not function correctly when the time code has not been recorded consecutively.

E

Advanced Functions
Playback

Date Search

You can locate the change of the date/time zone with the date search function.

This function is operated with the wireless controller.

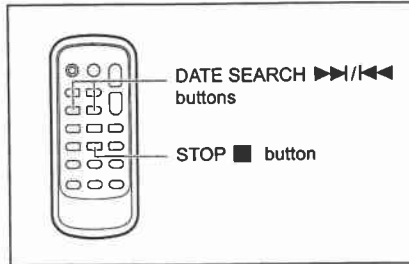

Press the >>> or <<< button to begin searching.

- Press more than once to search for further date changes (up to 10 times).
- Press the STOP ■ button to stop searching.

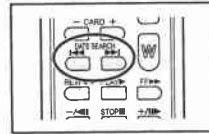

- A recording of longer than a minute per date/area is required.
- Date search may not function if the data code is not correctly displayed.

Customizing the Camcorder

You can personalize your camcorder by customizing the start-up image and the sound it makes for start-up, shutter, operation and self-timer (collectively called the My Camera settings).

Changing the My Camera Settings

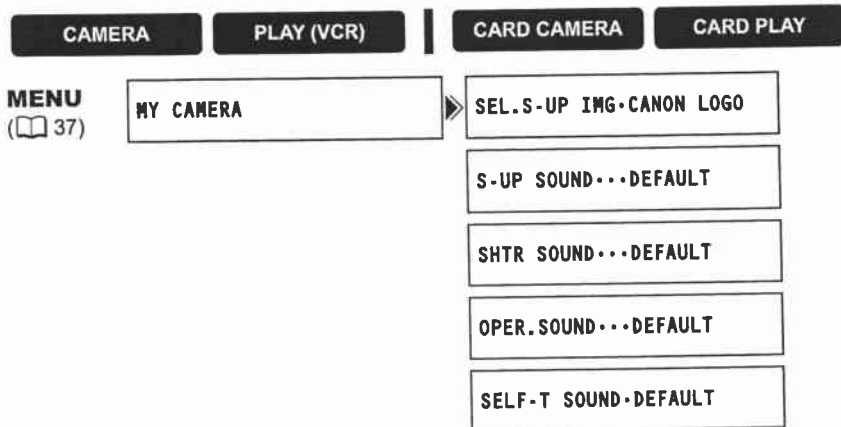

1. Open the menu and select [MY CAMERA].
2. Select the menu item you wish to change.
When selecting a start-up image, set the camcorder to CARD PLAY mode.
3. Select a setting option and close the menu.



- You can save your original images, or the images and sounds contained in the supplied software (ZoomBrowser EX for Windows or ImageBrowser for Macintosh) to the setting options [MY IMAGE] and [MY SOUND]. For details, refer to the *Digital Video Software Instruction Manual*.
- You can also create original start-up images (□ 118).

Changing the Display Language

The language used for screen display and menu items can be changed. The available set of languages varies depending on the region. Follow the procedure below to check which set of languages are provided with your camcorder.

Language Set A (e.g. Europe)	Language Set B (e.g. Asia, Australia)
English, German, Spanish, French, Italian, Russian, Simplified Chinese, Japanese	English, Simplified Chinese, Traditional Chinese, Korean

CAMERA

PLAY (VCR)

CARD CAMERA

CARD PLAY

MENU
(37)

DISPLAY SETUP/

▶ LANGUAGE ... ENGLISH

To change the display language, open the menu and select [DISPLAY SETUP/]. Select [LANGUAGE], select a language and close the menu.



- If you have mistakenly changed the language, follow the mark next to the menu item to change the setting.
- The displays "**MENU**" and "**SET**" at the bottom of the screen refer to the button names on the camcorder and will not change when you change the language.

Changing the Date Format

You can select between three date formats. For example, [1. JAN. 2005], [JAN. 1, 2005] and [2005. 1. 1].

CAMERA

PLAY (VCR)

CARD CAMERA

CARD PLAY

MENU
(37)

DISPLAY SETUP/

▶ DATE FORMAT.. 1.JAN.2005

Open the menu and select [DISPLAY SETUP/]. Select [DATE FORMAT], select a format and close the menu.

Other Camcorder Settings

Beep

You will hear a beep upon camcorder operations such as power on/off, start/stop, self-timer countdown, and unusual conditions of the camcorder.

If you turn off the beep, all camcorder sounds including the ones of the My Camera settings will be turned off.

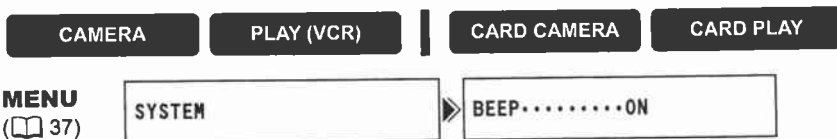

To turn the beep off, open the menu and select [SYSTEM]. Select [BEEP], set it to [OFF] and close the menu.

Adjusting the Brightness of the LCD Screen

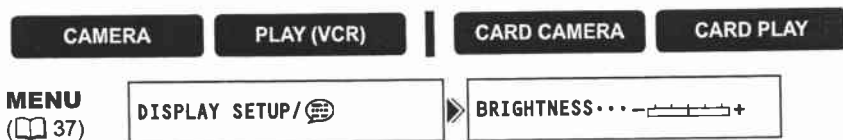

Open the menu and select [DISPLAY SETUP/ (speech bubble icon)]. Select [BRIGHTNESS], adjust the brightness level and close the menu.



Changing the brightness of the LCD screen does not affect that of the viewfinder or the recordings.

Turning the Remote Sensor Off

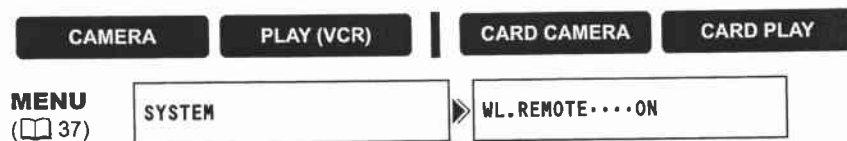

Open the menu and select [SYSTEM]. Select [WL.REMOTE], set it to [OFF] (off icon) and close the menu.
“(off)” appears.

Turning Off the Image Stabilizer

The image stabilizer compensates for camcorder shake even at full telephoto. It tries to compensate for horizontal movements; therefore, you may decide to turn it off when you mount the camcorder on a tripod.



Open the menu and select [CAMERA SETUP]. Select [IMG STAB (📷)], set it to [OFF] and close the menu.

"📷" disappears.



- The image stabilizer cannot be turned off when the program selector is set to EASY.
- The image stabilizer is designed to compensate a normal degree of camcorder shake.
- The image stabilizer might not be as effective when using the night modes.

Demonstration Mode

The demonstration mode displays the camcorder's main features. It starts automatically when you leave the camcorder turned on without loading a recording media for more than 5 minutes. However, you can set the camcorder not to start the demonstration mode.



Open the menu and select [DISPLAY SETUP/🗨️]. Select [DEMO MODE], set it to [OFF] and close the menu.



To cancel the demo mode once it has begun, press any button, turn off the camcorder or load a recording media.

Recording to a VCR or Digital Video Device

You can copy your recordings by connecting the camcorder to a VCR or a digital video device. If you connect a digital video device, you can copy recordings with virtually no generation loss in image and sound quality.

Connecting the Devices

① Connecting a VCR

See *Playing Back on a TV Screen* (□ 34).

② Connecting a Digital Video Device

Refer also to the instruction manual of the digital video device.

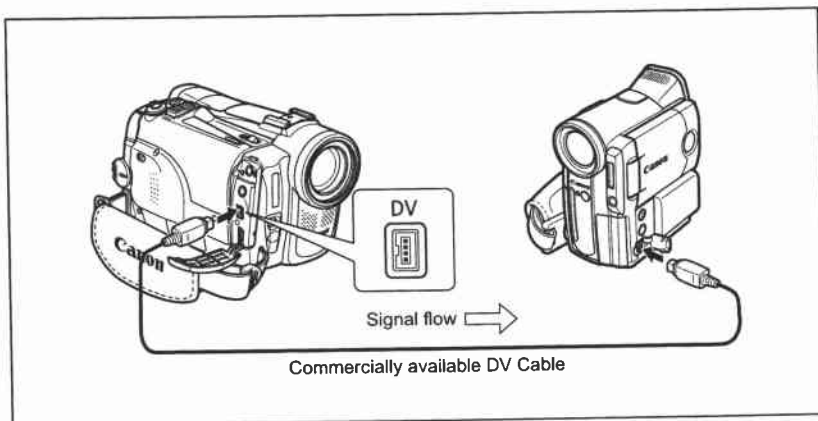

Recording



1. **Set the camcorder to PLAY (VCR) mode and load a recorded cassette.**
If you are connecting via AV terminal, check the setting (□ 34).
2. **Connected device: Load a blank cassette and set the device to record pause mode.**
3. **Locate the scene you wish to copy and pause playback shortly before the scene.**
4. **Play back the tape.**
5. **Connected device: Begin recording when the scene you wish to copy appears. Stop recording when copying is complete.**
6. **Stop playback.**



- When connecting a VCR, the quality of the edited tape will be slightly lower than that of the original.
- When connecting a digital video device:
 - If the picture does not appear, reconnect the DV cable or turn the camcorder off and back on again.
 - Proper operation cannot be guaranteed for all digital video devices equipped with a DV terminal. If operation does not work, use the AV terminal.
- We recommend powering the camcorder from a household power source.

MX350i/MX330i Recording from Analog Video Devices (VCR, TV or Camcorder)

You can record videos or TV programs from a VCR or analog camcorder on the tape in the camcorder.



1. **Connect the camcorder to the analog video device.**
See *Playing Back on a TV Screen* (□ 34).
2. **Set the camcorder to PLAY (VCR) mode and load a blank cassette.**
3. **Connected device: Load the recorded cassette.**
4. **Press the REC PAUSE button.**

In record pause mode and during recording, you can check the picture on the screen.

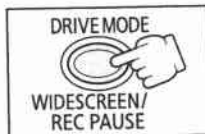

5. **Connected device: Play back the tape.**
6. **Press the ►/|| button when the scene you wish to record appears.**
Recording starts.

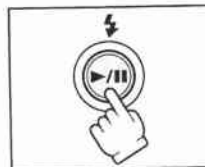

7. **Press the ■ button to stop recording.**
 - Press the ►/|| button to pause recording.
 - Press the ►/|| button again to restart recording.
8. **Connected device: Stop playback.**



- ⚠ Headphones cannot be used during analog line-in recording.
- ⚠ When connecting to a TV/Video with SCART terminal, use a SCART adapter with input capability (commercially available). The supplied SCART Adapter PC-A10 is for output only.
- ⚠ Depending on the signal sent from the connected device, dubbing may not work properly (e.g. signals that include copyright protective signals or anomalous signals such as ghost signals).



We recommend powering the camcorder from a household power source.

MVX350i/MVX330i Recording from Digital Video Devices (DV Dubbing)

You can record from other digital video devices equipped with a DV terminal with virtually no loss in picture and sound quality.

CAMERA

PLAY (VCR)

CARD CAMERA

CARD PLAY

1. Connect the camcorder to the digital video device.

See *Connecting a Digital Video Device* (□ 79).

2. Set the camcorder to PLAY (VCR) mode and load a blank cassette.

Make sure that [AV → DV] is set to [OFF] (□ 85).

3. Connected device: Load the recorded cassette.

4. Press the REC PAUSE button.

In record pause mode and during recording, you can check the picture on the screen.

5. Connected Device: Play back the tape.

6. Press the ►/|| button when the scene you wish to record appears.

Recording starts.

7. Press the ■ button to stop recording.

- Press the ►/|| button to pause recording.
- Press the ►/|| button again to restart recording.

8. Connected Device: Stop playback.

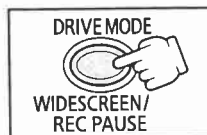

- Blank sections may be recorded as anomalous picture.
- If the picture does not appear, reconnect the DV cable or turn the camcorder off and back on again.
- You can only record signals from devices with the **DV** logo recording in SD system in SP or LP format (note that signals from identically shaped terminals may be of different format □ 152).



We recommend powering the camcorder from a household power source.

Concerning Copyright

Copyright Precaution

Certain pre-recorded video tapes, films and other materials, as well as some television programs are copyrighted. Unauthorised recording of these materials may violate copyright protection laws.

Copyright Signals

During playback: If you try to play back a tape that contains copyright control signals for protection of software, "COPYRIGHT PROTECTED PLAYBACK IS RESTRICTED" appears for a few seconds and the camcorder displays a blank blue screen. You cannot playback the contents of the tape.

During recording: If you try to record from software that contains copyright control signals for protection of software, "COPYRIGHT PROTECTED DUBBING RESTRICTED" appears. You cannot record the contents of the software.
You cannot record copyright protection signals to a tape using this camcorder.

MVX350i / MVX330i **Converting Analog Signals into Digital Signals (Analog-Digital Converter)**

By connecting the camcorder to a VCR or 8mm video camcorder, you can convert analog video/audio signals to digital signals and output the digital signals via the DV terminal. The DV terminal serves as output terminal only.

Connecting the Devices

Turn off all devices before starting the connections. Unload the tape from the camcorder. Refer also to the instruction manual of the connected device.

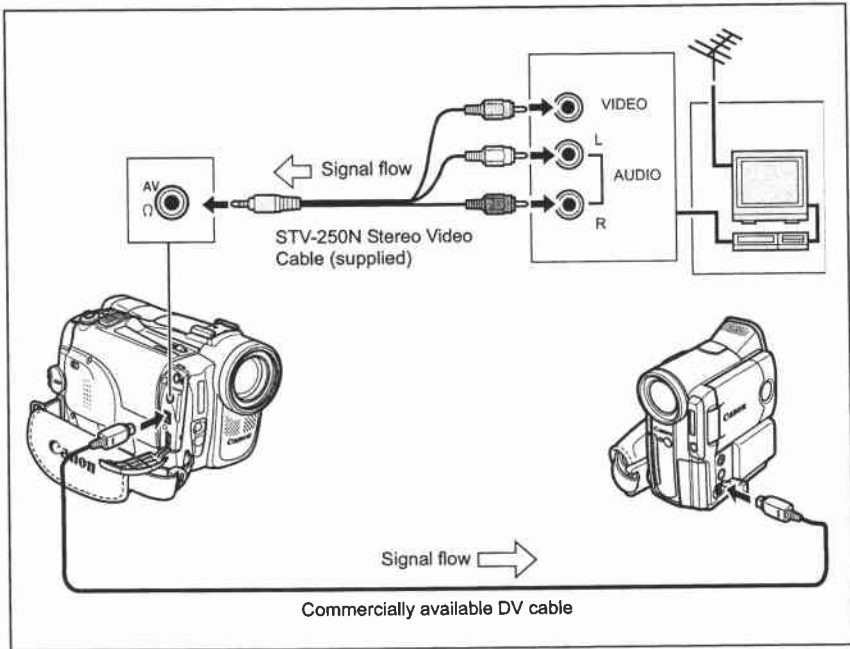

Turning On the Analog-Digital Converter

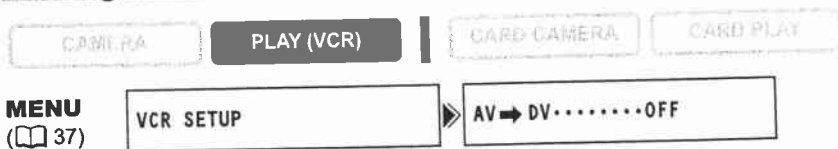

Open the menu and select [VCR SETUP]. Select [AV → DV], set it to [ON] and close the menu.



- Headphones cannot be used during analog-digital conversion.
- Depending on the signal sent from the connected device, the conversion from analog to digital signals might not work properly (e.g., signals that include copyright protective signals or anomalous signals such as ghost signals).
- When connecting to a TV/Video with SCART terminal, use a SCART adapter with input capability (commercially available). The supplied SCART Adapter PC-A10 is for output only.
- For normal use, set [AV → DV] to [OFF]. If it is set to [ON], digital signals cannot be input via the camcorder's DV terminal.
- Depending on the software and the specifications of your computer, you may not be able to transfer converted signals via the DV terminal.



We recommend powering the camcorder from a household power source.

Audio Dubbing

You can add sound with the built-in microphone. With the MVX350i/MVX330i, you can also add sound from audio devices or with an external microphone.

This function is operated with the wireless controller.

MVX350i/MVX330i Connecting

① Connecting an Audio Device

Refer also to the instruction manual of the connected device.

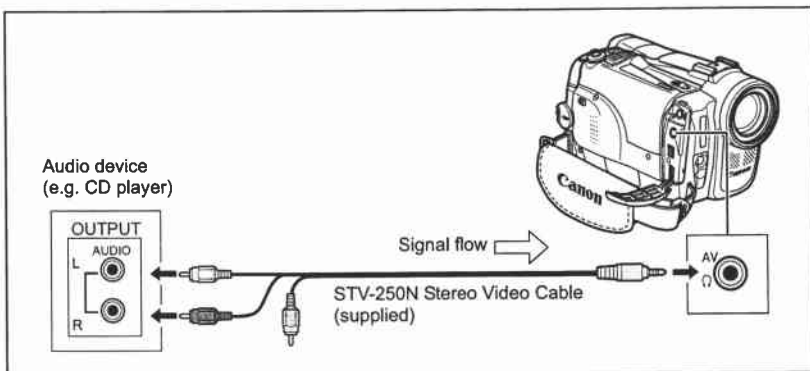

② Connecting a Microphone

See *Recording with an External Microphone* (□ 61).

Dubbing



1. Set the camcorder to **PLAY (VCR)** mode and load a recorded cassette. Use a tape recorded in SP, 12-bit mode with this camcorder.
2. **MVX350i/MVX330i** Open the menu and select **[AUDIO SETUP]**. Select **[AUDIO DUB.]**, set it to **[AUDIO IN]** or **[MIC.IN]** and close the menu.
3. Locate the scene you wish to start audio dubbing.
4. Press the **PAUSE** **||** button on the wireless controller.

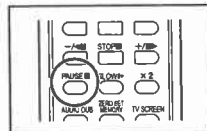

5. Press the **AUDIO DUB.** button on the wireless controller.

"AUDIO DUB." and "⏸" appear.

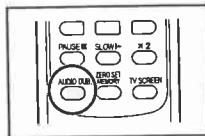

6. Press the **PAUSE II** button on the wireless controller to begin dubbing.

- **MVX350i/MVX330i** Audio device: Begin playback.
- Microphone: Speak into the microphone.

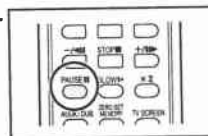

7. Press the **STOP ■** button on the wireless controller to stop dubbing.

MVX350i/MVX330i Audio device: Stop playback.

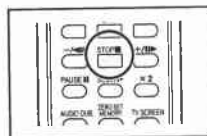

- Use only tapes recorded in SP mode 12-bit audio sound with this camcorder. Audio dubbing will stop if the tape has a blank section or a section recorded in LP mode or 16-bit mode.
- **MVX350i/MVX330i** When using the built-in microphone, do not connect any devices to the MIC terminal.
- You cannot use the DV terminal for audio dubbing.
- If you add sound to a tape not recorded with this camcorder, sound quality may decrease.
- Sound quality may decrease when you add sound to the same scene for more than 3 times.



- You can check the picture on the LCD screen.
- **MVX350i/MVX330i** When you connect an audio device, check the sound via built-in speaker or audio device.
- When you use a microphone, you can check the picture on a TV connected via the AV terminal and the sound via headphones connected to the TV.
- Set the zero set memory at the end of the scene you wish to dub audio. The camcorder will automatically stop audio dubbing at that point.

Playing Back the Added Sound

You can select to play back Stereo 1 (original sound), Stereo 2 (added sound), or adjust the balance of both sounds.

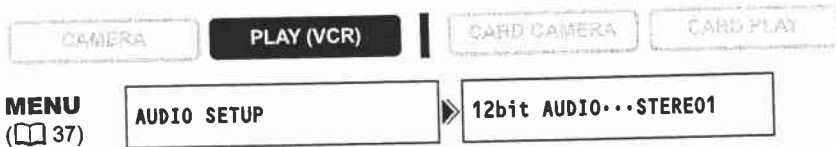

1. Open the menu and select [AUDIO SETUP]. Select [12bit AUDIO], select a setting and close the menu.

- STEREO1: Plays back the original sound.
- STEREO2: Plays back the added sound.
- MIX/FIXED: Plays back Stereo 1 and Stereo 2 in the same level.
- MIX/VARI.: Plays back Stereo 1 and Stereo 2. The mix balance can be adjusted.

2. If you have selected [MIX/VARI.], adjust the mix level: Open the menu and select [AUDIO SETUP]. Select [MIX BALANCE], adjust the balance with the SET dial and close the menu.

Turn the SET dial down to increase the volume of Stereo 1 and up to increase the volume of Stereo 2.



The camcorder resets to [STEREO1] when you turn the camcorder off. However, the mix balance is memorized by the camcorder.

Transferring Video Recordings to a Computer (IEEE1394)

E

You can transfer recordings to a computer equipped with a IEEE1394 (DV) terminal or IEEE1394 capture board. Use the editing software supplied with your computer/capture board to transfer video recording from tape to computer. Refer to the instruction manual of the software. A driver is preinstalled on Windows operating systems later than Windows 98 Second Edition and Mac operating systems later than Mac OS 9, and will be installed automatically.

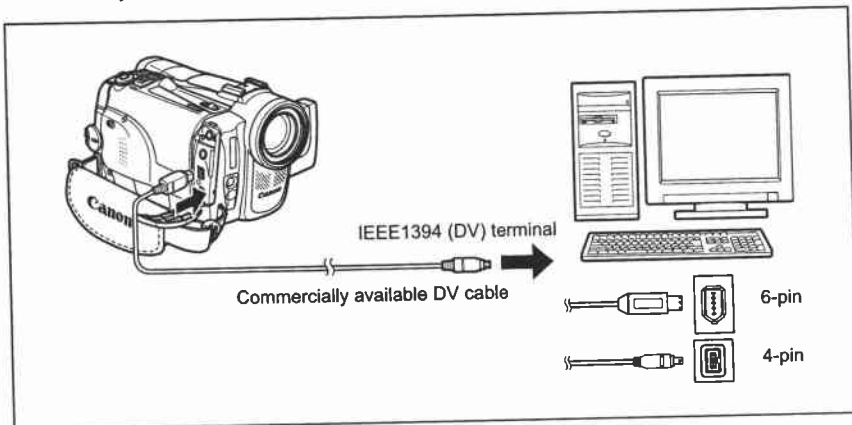

- Operation may not work correctly depending on the software and the specifications/settings of your computer.
- If the computer freezes while you have connected the camcorder, disconnect and reconnect the DV cable. If the problem persists, disconnect the interface cable, turn off camcorder and computer, turn camcorder and computer back on and reconnect them.
- Before connecting the camcorder to the computer using a DV cable, make sure that camcorder and computer are not connected with a USB cable, and that no other 1394 device is connected to the computer.



- We recommend powering the camcorder from a household power source while it is connected to the computer.
- Refer also to the instruction manual of the computer.

Editing

Inserting and Removing a Memory Card

You can use **SD** SD Memory Cards or commercially available MultiMediaCards with this camcorder. The SD Memory Card has a protect switch to prevent accidental erasure.

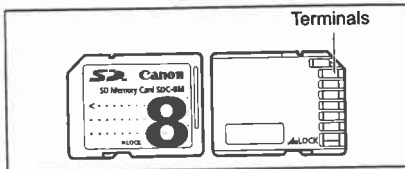

Inserting the Card

1. Turn off the camcorder.
2. Open the cover.
3. Insert the memory card all the way into the memory card slot.
4. Close the cover.

Do not close the cover forcefully without having the card correctly inserted.

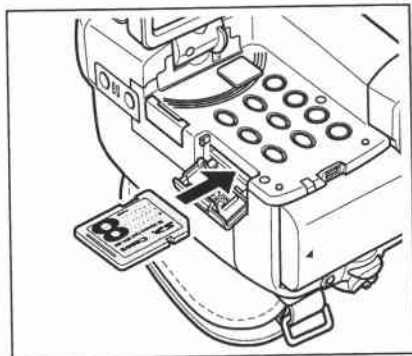

Removing the Card

Do not forcefully remove the memory card without first pushing it in.

1. Turn off the camcorder.
Make sure that the card access indicator is not flashing before you turn off the camcorder.
2. Open the cover.
3. Push the memory card to release it. Remove the memory card.
4. Close the cover.

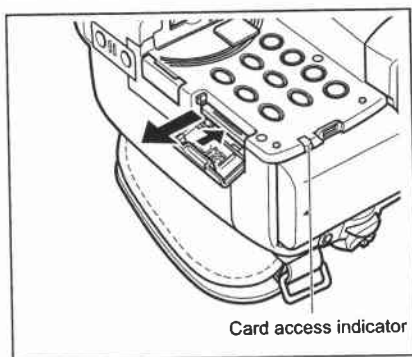

- This camcorder is compatible with SD Memory Cards or MultiMediaCards only. Do not use any other types of memory cards.
- Proper operation cannot be guaranteed for all memory cards.
- Turn off the camcorder before inserting or removing the memory card. Otherwise, it may result in data damage.
- If you use memory cards other than the supplied one, make sure to format them with the camcorder (□ 117).

Selecting the Image Quality/Size

Changing the Still Image Quality

You can choose from Superfine, Fine and Normal.

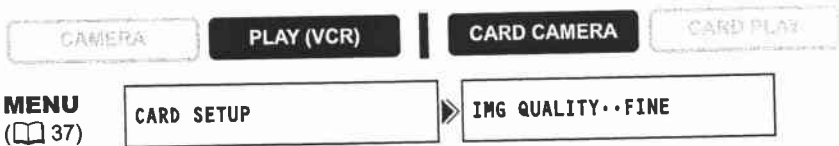

Open the menu and select [CARD SETUP]. Select [IMG QUALITY], set it to [SUPER FINE] or [NORMAL] and close the menu.

Changing the Still Image Size

You can choose from 1280 x 960 pixels and 640 x 480 pixels.

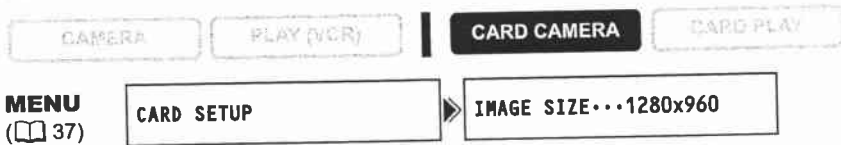

Open the menu and select [CARD SETUP]. Select [IMAGE SIZE], set it to [640x480] and close the menu.



- Still images are recorded with JPEG (Joint Photographic Experts Group) compression.
- Estimated Capacity of an 8 MB Memory Card:

Image Size	1280 x 960		640 x 480	
	No. of Images	File Size per Image	No. of Images	File Size per Image
Superfine	6	850 KB	34	175 KB
Fine	10	550 KB	50	120 KB
Normal	18	300 KB	84	65 KB

These figures are approximate. They vary according to the recording condition and the subject.

Changing the Movie Size

You can choose between 320 x 240 pixels and 160 x 120 pixels.



MENU
( 37)

CARD SETUP

▶ MOVIE SIZE...320x240

Open the menu and select [CARD SETUP]. Select [MOVIE SIZE], set it to [160x120] and close the menu.



- Movies are recorded with Motion JPEG compression.
- Maximum recording time on a 8 MB SD Memory Card:

Image Size	Recording Time (8 MB)	File Size per Second
320 x 240	approx. 20 sec.	250 KB/sec.
160 x 120	approx. 50 sec.	120 KB/sec.

File Numbers

Images are automatically assigned file numbers from 0101 to 9900 and stored in folders containing up to 100 images. Folders are assigned numbers from 101 to 998.

You can choose to use consecutive file numbers (CONTINUOUS) or to reset the file number each time a different memory card is inserted (RESET). We recommend setting the file numbers to CONTINUOUS.

RESET	The file number will be reset each time a new memory card is inserted. If the memory card already contains image files, the consecutive file number will be assigned.
CONTINUOUS	The camcorder memorizes the file number of the last image and assigns the consecutive file number to the next image, even when a new memory card is inserted. (If a higher file number already exists on the memory card, the consecutive number will be assigned.) There will be no duplication of file numbers. This is useful for organizing images on a computer.

Example:

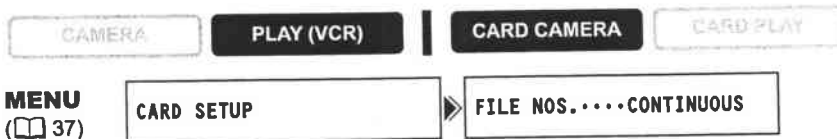
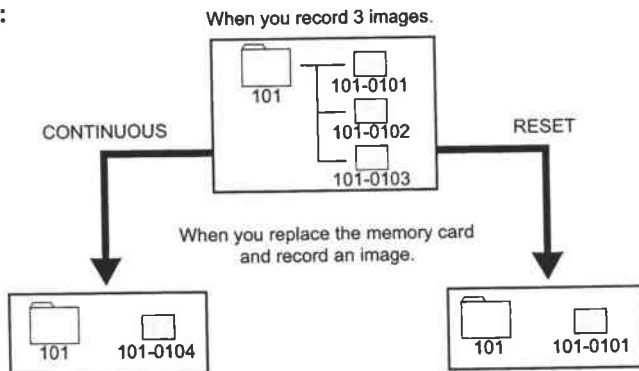

To change the setting, open the menu and select [CARD SETUP]. Select [FILE NOS.], set it to [RESET] and close the menu.

Recording Still Images on a Memory Card

You can record still images with the camcorder, from a tape in the camcorder or from devices connected via the DV terminal or AV terminal. You can also record a still image on the memory card while you record a movie on the tape.

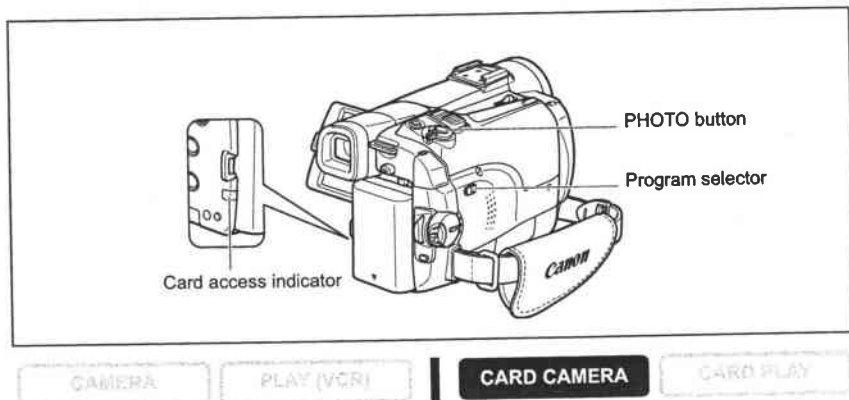

1. Set the camcorder to **CARD CAMERA** mode.

A white focusing frame appears in the center of the screen. The camcorder will focus on the subject in the center of the screen. To change the focusing point, see *Selecting the Focusing Point* (□ 104).

2. Press the **PHOTO** button halfway.

-  and focusing frame turn green when focus is adjusted. The beep sounds twice. The picture may appear out of focus for a moment while the camcorder is focusing.
- Exposure is locked.
- When you press the PHOTO button on the wireless controller, recording starts immediately.

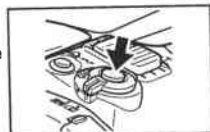

3. Press the **PHOTO** button fully.

-  and focusing frame disappear and you hear a shutter sound.
- The card access indicator flashes and the card access display appears.
- The still image shown on the screen will be recorded on the memory card.



- Do not turn off the camcorder, change the position of the TAPE/CARD switch, disconnect the power source, open the memory card cover or remove the memory card while the card access indicator is flashing. Doing so could result in data damage.
- When you are using a SD Memory Card, make sure that the protect switch is set to allow recording.



- Depending on the number of images on the memory card (Windows: more than 1800 images; Macintosh: more than 1000 images), you may not be able to download images to a computer. In such case, use a PC card reader.
- Connection to a PictBridge compliant printer will not work when the memory card contains more than 1800 images. For best performance, we recommend to keep the number of images on the memory card less than 100.
- When the subject is too bright, the ND filter turns on automatically ("ND" appears on the screen). If it is still too bright, "OVEREXP" starts flashing. In such case, use the optional FS-34U ND filter. If you wish to turn off the ND filter: Open the menu and select [CAMERA SETUP]. Select [ND], set it to [OFF] and close the menu.
- **When the Focus-Priority mode is set to [ON]:**
When you press the PHOTO button fully before ● and focusing frame turn green, it may take up to 2* seconds until focus is adjusted and the still image can be recorded to the memory card.
* Up to 4 seconds in the Low Light and the night modes.
If the subject is not suitable for autofocus, the focusing frame turns yellow and locks the focus. Adjust the focus manually with the SET dial.
- **When the Focus-Priority mode is set to [OFF]:**
No focusing frame appears.
In step 2, ● turns green, and focus and exposure are locked.
- The camcorder shuts off when you do not operate it for 5 minutes to save power. "▲ AUTO POWER OFF" appears 20 seconds before shutoff. To continue recording, turn the POWER switch to OFF and then back to CAMERA.

Screen Displays during Still Image Recording



① Still Image Quality

Indicates the image quality of the still image.

② Remaining Card Capacity for Still Images

- ☐ flashing in red: No card
- ☐ in green: 6 or more images
- ☐ in yellow: 1 to 5 images
- ☐ in red: No more images
- The indication may not decrease even though a recording has been made, or may decrease by 2 images at once.
- All indicators are displayed in green when a memory card is played back.

▶ Card Access Display

Indicates that the camcorder is writing on the memory card.

③ Image Size

Indicates the still image size.

Recording a Still Image on a Memory Card While Recording Movies on a Tape

When you are recording a movie on a tape, you can record the same picture as a still image on the memory card. Select the image quality from normal or fine.



1. Open the menu and select [CAMERA SETUP]. Select [STILL I.REC], set it to [FINE] or [NORMAL] and close the menu.
2. While you are recording a movie, press the PHOTO button.



- The size of the still image will be 640 x 480.
- The quality of the still image is slightly lower than a still image recorded in CARD CAMERA mode.
- The still image cannot be recorded on a memory card when a fader, effect or the multi-image screen is activated.
- The still image cannot be recorded on a memory card when the widescreen mode is selected.
- " OFF" appears when you press the PHOTO button when [STILL I.REC] is set to [OFF].

Recording from a Tape in the Camcorder



1. Play back the tape.
2. Press the PHOTO button halfway when the scene you wish to record appears.
 - The camcorder pauses playback. The remaining image capacity and other information appear.
 - When you press the PHOTO button on the wireless controller, recording starts immediately.
3. Press the PHOTO button fully.
 - The card access indicator flashes.
 - You can also record a still image by pressing the PHOTO button fully when the tape is in playback pause mode.

MVX350i / MVX330i Recording from Other Video Devices

You can record images from devices connected via the AV terminal (analog line-in function), or via the DV terminal as still images on a memory card. For connecting instructions, refer to page 34 and 79.

CAMERA

PLAY (VCR)

CARD CAMERA

CARD PLAY

1. Set the camcorder to PLAY (VCR) mode.

- If a cassette is loaded, make sure that the tape is stopped.
- When recording via the AV terminal, make sure that "AV ⇒ DV" is displayed on the screen. When recording via the DV terminal, make sure that "AV ⇒ DV" is not displayed. Change the setting as necessary (□ 85).

2. Connected device: Load a recorded cassette and play back the tape.

3. Press the PHOTO button halfway when the scene you wish to record appears.

- The still image, remaining image capacity and other information appear.
- When you press the PHOTO button on the wireless controller, recording starts immediately.

4. Press the PHOTO button fully.

The card access indicator flashes.



- When recording from a tape in the camcorder or other video devices:
 - A still image recorded from an image in widescreen mode will be vertically compressed.
 - The data code of the still image will reflect the date and time it has been recorded on the memory card.
 - The size of the still image will be 640 x 480. The still image quality can be selected.
- When connecting with a DV cable, make sure that no USB cable is connected to the camcorder.

MX350i/MX330i Using the Flash

You can use the built-in flash for recording still images in dark places. The flash is equipped with the red-eye reduction mode.

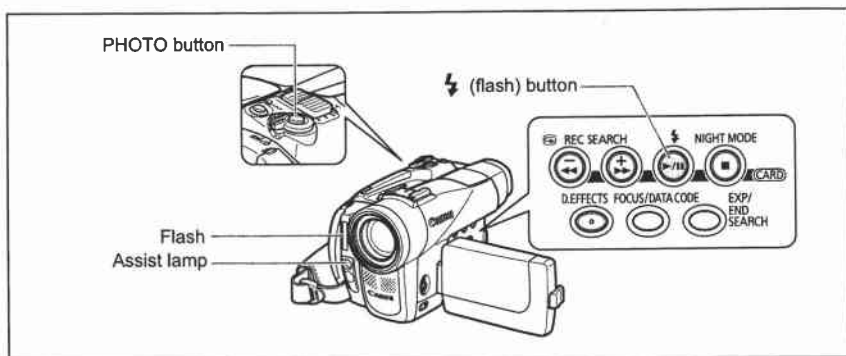

Selecting the Flash Mode

⚡ (auto)	The flash fires automatically according to the brightness of the subject.
👁️ (red-eye reduction, auto)	The flash fires automatically according to the brightness of the subject and the assist lamp lights up to reduce the red-eye effect.
⚡ (flash on)	The flash always fires.
🚫 (flash off)	The flash does not fire. Use this setting in places where flash photography is prohibited.

CAMERA

PLAY (VCR)

CARD CAMERA

CARD PLAY

Press the ⚡ (flash) button.

- The setting changes with each press of the button.
- The symbol of the selected flash mode appears on the screen. "⚡" disappears after 4 seconds.

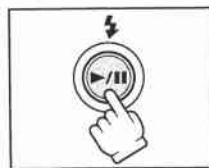

Recording with Flash

1. Press the PHOTO button halfway.

- "⚡" appears in green.
- In CAMERA mode, the flash can be used in record pause mode when [STILL I.REC] is set to [👍 FINE] or [👍 NORMAL].



2. Press the PHOTO button fully.

The flash fires.

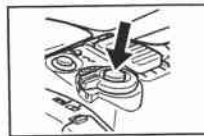

E



- Do not fire the flash close to people's eyes.
- Do not fire the flash at persons while they are driving.
- Do not fire the flash with the flash bulb covered with your hand.



- The practical range of the flash is approx. 1 to 2 m (3.3 to 6.6 ft.). The range depends upon the recording condition.
- The range of the flash decreases in continuous shooting mode.
- A pre-flash is fired to obtain the subject's exposure data to adjust the main flash to the optimal intensity (flash exposure compensation).
- For the red-eye reduction mode to be effective, the subject needs to look at the assist lamp. The degree of reduction depends upon the distance and on each individual.
- The flash will not fire in the following cases:
 - When you press the EXP button in $\frac{1}{2}$ (auto) or \odot (red-eye reduction, auto) mode.
 - When recording movies on a tape.
 - When [STILL I.REC] is set to [OFF] in CAMERA mode.
 - When a shutter speed of 1/2000 is set in $\frac{1}{2}$ (auto) or \odot (red-eye reduction, auto) and in CAMERA mode.
 - When the multi-image screen is selected.
 - During auto exposure bracketing.
 - When an abnormality occurs during charging.
- When $\frac{1}{2}$ (flash on) is selected and a shutter speed of 1/2000 is set in CAMERA mode, the shutter speed becomes set to 1/1000 and the flash fires.
- We recommend not using the flash when the wide attachment (supplied with the MVX350i), the optional Wide-converter or Tele-converter is attached. Their shadows appear on the screen.
- The flash mode cannot be selected when exposure is locked, or after the first still image in Stitch Assist mode.
- The red-eye reduction mode cannot be used in stitch assist mode.
- **About the AF-Assist Lamp:**

While the PHOTO button is pressed halfway, the assist lamp may light up as AF-assist lamp responding to the brightness of the subject to enable the camcorder to focus more accurately.

 - The camcorder may not be able to focus even though the AF-assist lamp is lighting.
 - The AF-assist lamp lights up brightly. Consider turning off the AF-assist lamp in public places such as in restaurants or theaters.



Reviewing a Still Image Right after Recording

You can select to display a still image for 2, 4, 6, 8 or 10 seconds after it has been recorded.



Open the menu and select [CAMERA SETUP]. Select [REVIEW], select a setting option and close the menu.



- A still image is displayed as long as you hold the PHOTO button after recording.
- The FILE OPER. menu appears when you press the SET dial while you are reviewing a still image, or when you press the SET dial right after recording. In this menu, you can protect (□ 111) or erase (□ 112) the image.
- [REVIEW] cannot be selected when  (continuous shooting),  (high-speed continuous shooting) or  (auto exposure bracketing) is selected.

Recording Motion JPEG Movies on a Memory Card

E

You can record Motion JPEG movies with the camcorder or from a tape in the camcorder. With the MVX350i/MVX330i, you can also record from devices connected via the DV terminal or the AV terminal. The sound of a movie recorded on a memory card will be monaural.

CAMERA

PLAY (VCR)

CARD CAMERA

CARD PLAY

1. Press the start/stop button to begin recording.

With SD Memory Cards up to 512 MB, you can record until "CARD FULL" appears (approx. 33 minutes in 320 x 240 with a 512 MB SD Memory Card). With MultiMediaCards, the recording time is limited to 10 sec. in 320 x 240 pixels and 30 sec. in 160 x 120 pixels.

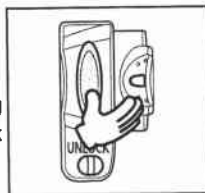

2. Press the start/stop button to stop recording.



○ Do not turn off the camcorder, change the position of the TAPE/CARD switch, disconnect the power source, open the memory card cover or remove the memory card while the card access indicator is flashing. Doing so could result in data damage.

○ When you are using a SD Memory Card, make sure that the protect switch is set to allow recording.

○ Do not load/unload a cassette during recording.



○ We recommend using a Canon SD Memory Card, or a SD Memory Card with a transfer rate of more than 2 MB/sec., right after you have formatted it with this camcorder. With memory cards not formatted with this camcorder, or when recording/erasing has been repeatedly performed, the writing speed may be lower and recording may stop.

○ You can select the focusing point when recording a movie on the memory card.

○ Users of Windows XP: When you plan to connect the camcorder to a computer using a USB cable, keep the length of one movie shorter than approx. 12 min. in 320 x 240 and 35 min. in 160 x 120.

○ The recording time varies according to the movie size, the recording condition and the subjects.

Screen Displays during Movie Recording



① Card Access Display

"▶" appears and "□" moves to indicate that the camcorder is writing on the memory card.

② Movie recording time

Indicates the recording time of the movie.

③ Image Size

Indicates the movie size.

④ Remaining Card Capacity for Movies

Indicates the remaining time in hours and minutes. At less than 1 minute, the remaining time will be displayed in 10 second-steps, at less than 10 seconds in 1 second-steps.

- The indication varies depending on the recording condition. The actual remaining time may be longer or shorter than indicated.

Recording from a Tape in the Camcorder



1. Play back the tape.
2. Press the start/stop button when the scene you wish to record appears.
3. Press the start/stop button to stop recording.

MVX350i/MVX330i Recording from Other Video Devices

You can record movies from devices connected via the AV terminal (analog line-in function), or via the DV terminal on a memory card. For connecting instructions, refer to page 34 and 79.



1. Set the camcorder to **PLAY (VCR)** mode.
 - If a cassette is loaded, make sure the tape is stopped.
 - When recording via the AV terminal, make sure that "AV⇒DV" is displayed on the screen. When recording via the DV terminal, make sure that "AV⇒DV" is not displayed. Change the setting as necessary (□ 85).
2. **Connected device: Load a recorded cassette and play back the tape.**
3. Press the start/stop button when the scene you wish to record appears.
4. Press the start/stop button to stop recording.



When recording from a tape in the camcorder or other video devices:

- A movie recorded from an image in widescreen mode will be vertically compressed.
- The data code of the movie will reflect the date and time it has been recorded on the memory card.

Selecting the Focusing Point

The subject you wish to record is not always in the center of the screen. In the Focus-Priority mode, you can choose from one of three focusing points to automatically put the subject you wish into sharp focus.

When the program selector is set to EASY, the Focus-Priority becomes set to ON (only the center focusing point is available).



1. Set the program selector to **P**.
2. Turn the **SET** dial to display all focusing frames.
3. Turn the **SET** dial to select the focusing point.

Turn the SET dial up to select the frame to the right, down to select the frame to the left.



- The focusing frame gives an indication of the focusing point. Depending on the size of the subject or the distance, the camcorder may focus outside the frame.
- When you operate the zoom lever, the frames other than the selected one disappear.
- The focusing point can be selected only when Focus-Priority is set to [ON] in CARD CAMERA mode.
- The focusing point returns to the center if you turn off the camcorder, change from CARD CAMERA mode or move the program selector to EASY.
- The focusing point cannot be selected in the following cases:
 - When using the digital zoom.
 - When exposure is locked.
 - In Stitch Assist mode.

Turning Off the Focus-Priority Mode

Turn off the Focus-Priority mode if you wish to put timing ahead of focus.





MENU
(37)

CAMERA SETUP

▶ FOCUS PRI...ON

Open the menu and select [CAMERA SETUP]. Select [FOCUS PRI.], set it to [OFF] and close the menu.

Selecting the Drive Mode

 Continuous Shooting	Captures a quick series of still images while you press the PHOTO button. For the number of frames per second, refer to the following table.
 High-Speed Continuous Shooting	
 AEB (Auto Exposure Bracketing)	The camcorder records a still image in three different exposures (dark, normal, light in 1/2 EV steps), allowing you to choose the perfect exposed shot.
Single	Records a single still image when you press the PHOTO button.

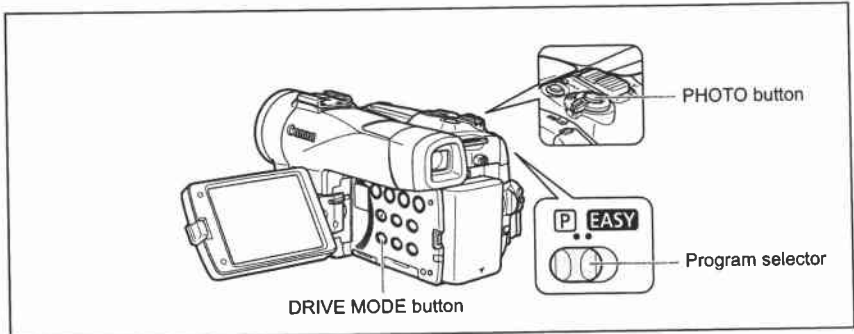

Changing the Drive Mode



1. Set the program selector to **P**.
2. Press the **DRIVE MODE** button to switch between the drive modes.
The setting changes with each press of the button.

Continuous Shooting/High-Speed Continuous Shooting



Press and hold the PHOTO button.

A series of still images will be recorded as long as you hold the PHOTO button.



- Maximum number of continuous shots at one time:

Still Image Size	Frames per Second		Maximum Number of Continuous Shots
	Normal speed	High speed	
1280 x 960	3 frames	5 frames	10 images
640 x 480	3 frames	5 frames	60 images

These figures are approximate and vary with the recording conditions and subjects. Sufficient space on the memory card is required. Continuous shooting stops when card is full.

- The number of frames per second will be lower when “” (camcorder shake warning) is displayed on the screen.
- In normal and high-speed continuous shooting mode, images are captured at 2 frames/second when using the flash.

Auto Exposure Bracketing



Press the PHOTO button.

Three still images in different exposures are recorded to the memory card.



Make sure that there is sufficient space on the memory card.

Recording Panoramic Images (Stitch Assist Mode)

You can shoot a series of overlapping images and merge them into one large panoramic scene using the supplied software (PhotoStitch) on a computer.

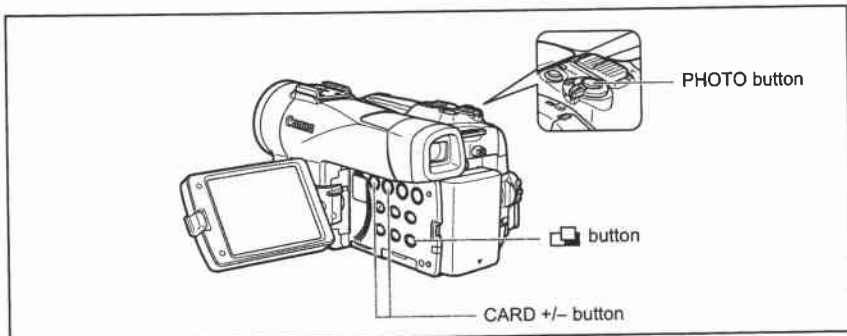

When Recording in Stitch Assist Mode:

PhotoStitch detects the overlapping portion of adjoining images and merges them. Try to include a distinctive item (landmark, etc.) in the overlapping portion.



1. Press the  button.



2. Select the direction with the **CARD +/-** button.

CARD + button: clockwise. CARD - button: counterclockwise.



3. Select the program **AE mode** and zoom on the subject.

Adjust focus and exposure manually as necessary. Once the sequence has started, you cannot change the program AE mode, exposure, zoom or focus.

4. Press the **PHOTO** button to record the first image.

Direction and number of recorded images appear.



5. Record the second image so that it overlaps a portion of the first image.

- Minor discrepancies in the overlapped area can be corrected with the software.
- You can retake an image by pressing the CARD +/- button to return to the previous image.
- A maximum of 26 images can be recorded.

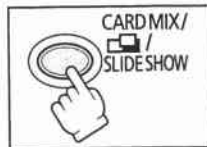

6. Press the  button after the last image.

For details on how to merge these images, refer to the *Digital Video Software Instruction Manual*.



- Compose each image so that it overlaps 30 to 50% of the adjoining image. Try to keep the vertical misalignment within 10%.
- Do not include a moving subject in the overlapping portion.
- Do not try to stitch images that include both distant and close subjects. They may appear warped or doubled up.

Playing Back a Memory Card

You can display a single image, 6 at one time (index screen ) 110), or one after another (slide show ) 110). Use the Card Jump function to quickly locate an image without displaying them one by one () 110).

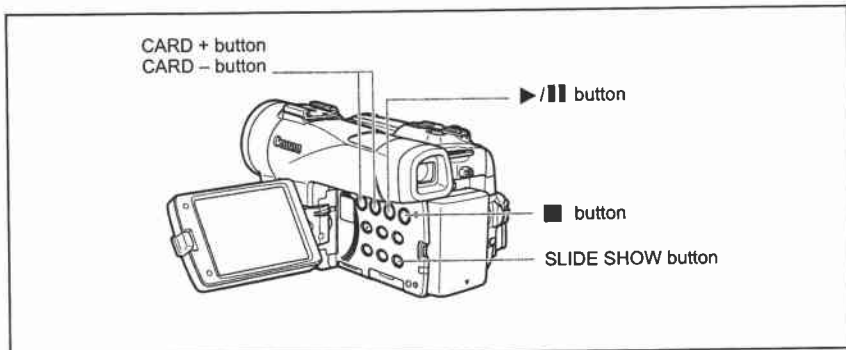

1. Set the camcorder to **CARD PLAY** mode.
2. Press the **CARD +/-** button to move between images.

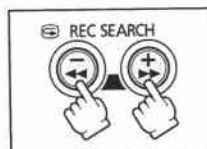

3. To play back a movie, press the **>/||** button.
 - The first scene appears as a still image when playback is complete.
 - Pressing the **>/||** button during playback pauses the playback. Press the **>/||** button again to restart playback.
 - Pressing the **■** button displays the first scene of the movie.
 - Press the **CARD +/-** button (or the **REW <</FF >>** button on the wireless controller) for 8x fast forward/fast rewind playback.

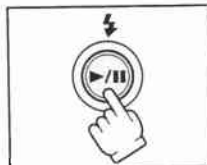

- Images not recorded with this camcorder, uploaded from a computer (except the sample images ) 115), edited on a computer and images whose file names have been changed may not be played back correctly.
- Do not turn off the camcorder, change the position of the TAPE/CARD switch, disconnect the power source, open the memory card cover or remove the memory card while the card access indicator is flashing. Doing so could result in data damage.

Slide Show



1. Press the **SLIDE SHOW** button.
Images are played back one after another.

2. Press the **SLIDE SHOW** button to stop the slide show.



Index Screen



1. Move the zoom lever toward **W**.

- Up to 6 images appear.
- With movies, the index screen can only be started when the first scene is displayed as a still image.

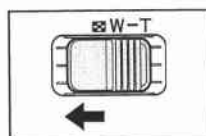

2. Turn the **SET** dial to select an image.

- Move the "☞" to the image you wish to view.
- You can switch between the index pages by pressing the **CARD +** or **CARD -** button.



3. Move the zoom lever toward **T**.

The index screen is canceled and the selected image is displayed.

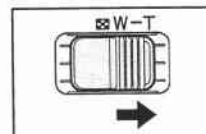

Card Jump Function

You can locate images without displaying them one by one. The number in the upper right of the screen indicates the image number of the current image by the total number of images.



Press and hold the **CARD +** or **CARD -** button.

- When you release the button, the image of the displayed image number appears.
- With movies, the card jump function can only be started when the first scene is displayed as a still image.

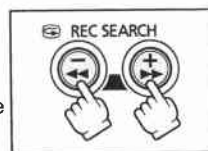

Protecting Images

You can protect important images from accidental erasure when displaying a single image or index screen.



If a memory card is formatted, all still images and movies, even protected ones, will be erased permanently.



Movies can only be protected when the first scene is displayed as a still image.



1. Select the image you wish to protect.
2. Press the SET dial to open the FILE OPER. menu.

In CARD CAMERA mode, the menu appears when you press the SET dial while you are reviewing a still image, or when you press the SET dial right after recording.

3. Select [**Oπ** PROTECT].
 - "Oπ" appears and now the image cannot be erased.
 - To cancel the protection, press the SET dial.
4. Select [**←** RETURN] to close the menu.

Protecting during Index Screen Display



MENU
(37)

CARD OPERATIONS

➡ **Oπ** PROTECT

1. Move the zoom lever toward **W**.
 - Up to 6 images appear.
 - Select the image you wish to protect.
2. Open the menu and select [CARD OPERATIONS]. Select [**→** Oπ PROTECT] and press the SET dial.
 - "Oπ" appears on the image.
 - To cancel the protection, press the SET dial.
3. Close the menu.

Erasing Images

You can erase images singly or all at once.



Be careful when erasing images. Erased images cannot be recovered.



○ Protected images cannot be erased.

○ Movies can only be erased when the first scene is displayed as a still image.

Erasing a Single Image



1. Select the image you wish to erase.

2. Press the SET dial to open the FILE OPER. menu.

In CARD CAMERA mode, the menu appears when you press the SET dial while you are reviewing a still image, or when you press the SET dial right after recording.

3. Select [IMAGE ERASE].

- "ERASE THIS IMAGE?", [NO] and [YES] appears.
- If an image is protected, [YES] appears in purple.

4. Select [YES].

The image is erased and the previous image appears.

5. Select [← RETURN] to close the menu.

Erasing a Single Image/All Images



MENU

(BOOK 37)

CARD OPERATIONS

▶ IMAGE ERASE

1. Open the menu and select [CARD OPERATIONS].

2. Select [IMAGE ERASE].

3. Select [SINGLE] or [ALL].

- When erasing a single image: "ERASE THIS IMAGE?", [NO] and [YES] appears. If an image is protected, [YES] appears in purple.
- When erasing all images: "ERASE ALL IMAGES? [EXCEPT FOR IMAGES]", [NO] and [YES] appears.

4. Select [YES] and close the menu.

- When erasing a single image: The image is erased and the previous image appears. To erase another image, select the image with the CARD +/- button and select [YES].
- When erasing all images: All still images or movies with exception of the protected ones are erased.

Combining Images (Card Mix)

You can produce effects not possible with just a tape with the Card Mix function. Choose one of the sample images provided on the supplied DIGITAL VIDEO SOLUTION DISK (such as picture frames, backgrounds and animations) and combine it with the live video recording.

E

Card Chroma Key (CARD CHROMA)

Combines frames with your recordings. The live video recording will appear in place of the blue area of the card mix image.

Mix level adjustment: blue area of the still image.



Card Luminance Key (CARD LUMI.)

Combines illustrations or title with your recordings. The live video recording will appear in place of the light area of the card mix image.

Mix level adjustment: light area of the still image.



Camera Chroma Key (CAM. CHROMA)

Combines backgrounds with your recordings. Record your subject in front of a blue curtain, and the subject not blue will be superimposed on the card mix image.

Mix level adjustment: blue area of the live video recording.

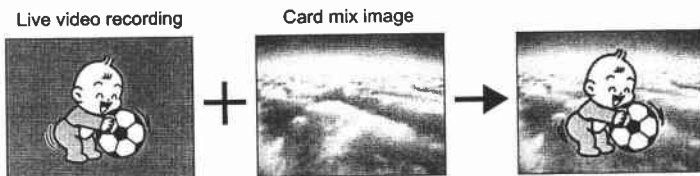

Card Animation (C. ANIMATION)

Combines animations with your recordings. You can choose from 3 types of card animation effects.

- Corner: Animation appears on the upper left and the lower right corner of the screen.
- Straight: Animation appears on the top and bottom of the screen and moves to the right and left.
- Random: Animation moves randomly in the display.

Mix level adjustment: blue area of the card animation image.

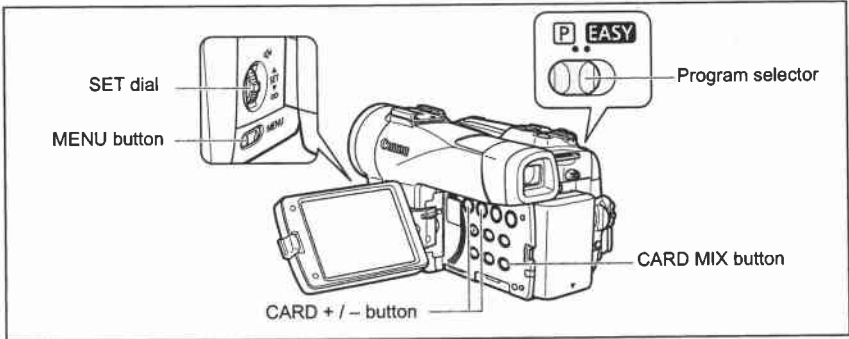
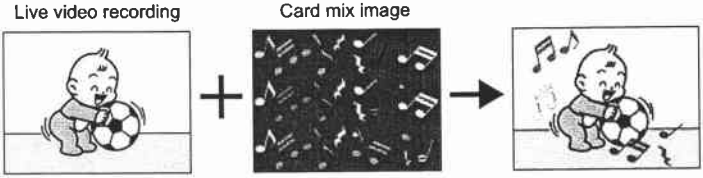

Selecting the Card Mix Effect

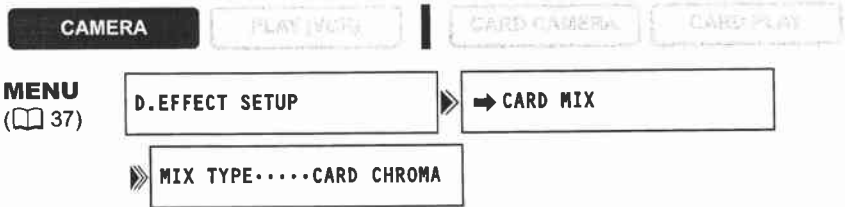

1. Upload a sample image from the **DIGITAL VIDEO SOLUTION DISK** to the memory card in the camcorder.

Refer to *Adding Still Images from Your Computer to the Memory Card* in the *Digital Video Software Instruction Manual*.

2. Set the program selector to **[P]**.

3. Open the menu and select **[D.EFFECT SETUP]**.

4. Select **[→ CARD MIX]**.

The card mix menu appears.

5. Select the image you wish to combine with the **CARD +/-** button.

6. Select **[MIX TYPE]**.

[CARD CHROMA], [CARD LUMI.], [CAM.CHROMA] and [C.ANIMATION] appears.

7. Select the mix type matching the sample image you have selected.

- The screen shows the combined image.
- When you have selected [C.ANIMATION], select [ANIMAT.TYPE] and select between [CORNER], [STRAIGHT] and [RANDOM].

8. To adjust the mix level, select [MIX LEVEL] and adjust it with the SET dial.

9. Close the menu.

"CARD MIX" flashes.

10. Press the CARD MIX button.

- "CARD MIX" stops flashing.
- The combined image appears.



○ Card mix cannot be used when [STILL I.REC] is set to [FINE] or [NORMAL].

○ Movies recorded on a memory card cannot be combined with camcorder recordings.

Sample Images

Below are some sample images provided on the supplied DIGITAL VIDEO SOLUTION DISK.

Card Chroma Key

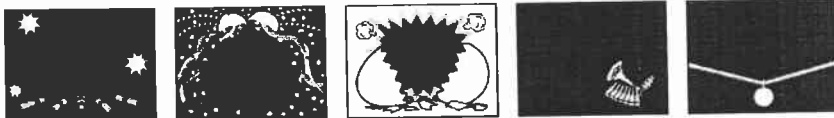

Card Luminance Key



Camera Chroma Key



Card Animation

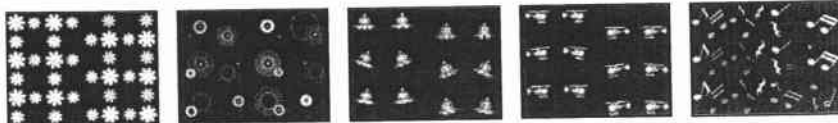



The sample images provided on the supplied DIGITAL VIDEO SOLUTION DISK are intended only for the personal use with this camcorder. Do not use these sample images for other purposes.

PhotoEssentials – Royalty Free Stock Photography

The PhotoEssentials suite of royalty-free images on CD-ROM features premium quality assignment photography and is ideally suited for use in advertising, brochures, reports, multimedia, websites, books, packaging and more.

For more information, please visit their website www.photoessentials.com

Formatting a Memory Card

Format new memory cards, or when you get the message "CARD ERROR". You can also format a memory card to erase all data recorded on it.

E



- Formatting a memory card erases all data, including protected images.
- Images erased by formatting cannot be recovered.
- If you use a memory card other than the supplied one, format it with the camcorder.

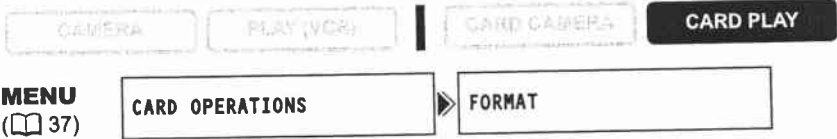

1. Open the menu and select [CARD OPERATIONS].
2. Select [FORMAT].
[CANCEL] and [EXECUTE] appears.
3. Select [EXECUTE].
[ALL DATA WILL BE ERASED. FORMAT THIS CARD?], [NO] and [YES] appears.
4. Select [YES] and close the menu.
 - Formatting starts.
 - Selecting [NO] brings you back to step 3.

Creating a Start-up Image

You can create a start-up image using a still image on the memory card.

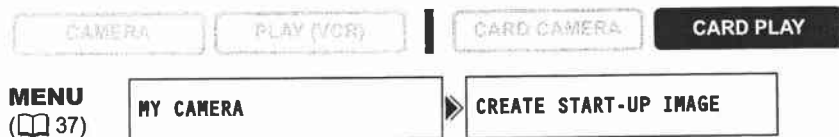

1. Select a still image with the **CARD +/-** buttons.
2. Open the menu and select **[MY CAMERA]**.
3. Select **[CREATE START-UP IMAGE]**.
[SET THIS AS START-UP IMAGE?], [YES] and [NO] appears.
4. Select **[YES]**.
[OVERWRITE MY IMAGE?], [NO] and [YES] appears.
5. Select **[YES]**.
The still image will be saved, and the image that was saved to **[MY IMAGE]** is erased.







Retain the original data of the still image you have set as the start-up image on your computer or removable disk.

Printing Still Images

You can print still images by connecting the camcorder to a printer with direct print function. You can also use the print order settings for direct printing (□ 129).

Following printers can be connected to your camcorder:

Canon Printers	PictBridge compliant SELPHY CP series printer*/Bubble Jet Printers (PIXMA series/SELPHY DS series)	 PictBridge
	Bubble Jet Direct compatible Bubble Jet Printer	 BUBBLE JET DIRECT
	CP-10/CP-100 CP-Printer	 DIRECT PRINT
PictBridge compliant non-Canon Printer		 PictBridge

*Includes the CP-330/CP-220/CP-300/CP-200.



If your CP-300 is not PictBridge compliant (does not carry the PictBridge logo), upgrade the printer firmware following the instructions on below website to enable use with this camcorder.

http://www.canon.co.jp/Imaging/cp300/cp300_firmware-e.html

If you cannot access the website, please contact:

- For Europe: A local Canon distributor listed in the Canon European Warranty System List included in the CP-300 kit.
- For other regions: Canon Customer Support Help Desk listed in the Canon Customer Support Leaflet included in the CP-300 kit.



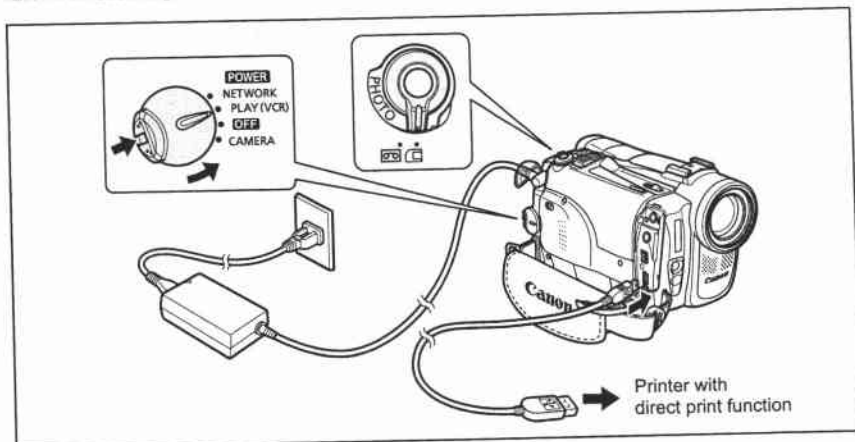

Connecting the Printer to the Camcorder







CARD PLAY

1. Turn off the camcorder and insert a memory card that contains still images.

2. Turn on the printer.
3. Set the camcorder to **CARD PLAY** mode.
4. Connect the camcorder to the printer using the cable.

-  appears and changes to ,  or  when the printer is properly connected to the camcorder. (Does not appear with movies, or still images that cannot be played back with the camcorder.)
- The  (print/share) button lights up and the current print setting will be displayed for approx. 6 seconds.



- If  continues to flash (for more than 1 minute) or if ,  or  does not appear, the camcorder is not correctly connected to the printer. In such case, disconnect the cable from camcorder and printer, turn off camcorder and printer, turn both back on and reconnect the camcorder to the printer.
- Do not connect the camcorder to a printer when the camcorder is set to a mode other than the **CARD PLAY** mode.



- Refer to the instruction manual of each printer for information on which interface cable to use with the camcorder.
The Canon CP-Printers CP-10 and CP-100 are supplied with two direct interface cables. Use the cable with the USB logo on the connector (DIF-100).
- We recommend powering the camcorder from a household power source.
- Refer also to the instruction manual of the respective printer.
- The print setting menu may differ slightly depending on the connected printer.

Printing with the (Print/Share) Button

You can print an image without changing the settings by simply pressing the  (print/share) button.



1. Select the still image you wish to print with the **CARD +/-** button.

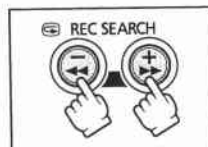

2. Press the  (print/share) button.

- Printing starts. The  button flashes and glows steadily when printing is complete.
- If you wish to continue printing, select another still image with the **CARD +/-** button.

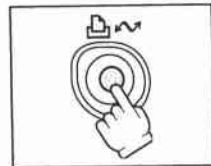

Printing after Selecting the Print Settings

You can select the number of copies and other settings for printing. The setting options vary depending on your printer model.



1. Press the SET dial.

- The print setting menu appears.
- Depending on the printer, the message "BUSY." may appear before the camcorder displays the print setting menu.

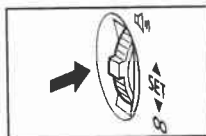

2. Select the print settings (□ 123).

3. Turn the SET dial to select [PRINT] and press the SET dial.

- Printing starts. The print setting menu disappears when printing is complete.
- If you wish to continue printing, select another still image with the CARD +/- button.



- Observe the following precautions during printing, otherwise printing may not be performed correctly.
 - Do not turn off the camcorder or the printer.
 - Do not change the position of the TAPE/CARD switch.
 - Do not detach the cable.
 - Do not open the memory card cover or remove the memory card.
- Images not recorded with this camcorder, uploaded from a computer, edited on a computer and images whose file names have been changed may not be printed correctly.
- If the message "BUSY." does not disappear, disconnect the cable from camcorder and printer and reconnect the camcorder to the printer.



○ **Cancel Printing**

Press the SET dial during printing. A confirmation dialog appears. Select [OK] and press the SET dial.

- Canon Printer: Printing stops even if it is incomplete and the paper is fed through.
- Canon CP-Printer CP-10/CP-100: A print in progress cannot be stopped. Printing stops when the current print is finished, and the remaining prints are canceled.

○ **Printing Errors**

If an error occurs during the printing process, an error message appears (□ 142).

- Canon Printer: Resolve the error. When printing does not resume automatically, select [CONTINUE] and press the SET dial. If [CONTINUE] cannot be selected, select [STOP], press the SET dial and retry printing. Refer also to the printer manual for details.
- Canon CP-Printer CP-10/CP-100: Select [STOP] or [RESUME] and press the SET dial. (The [RESUME] setting may not appear with some error messages. In that case, select [STOP].) Refer also to the printer manual for details.
- If the error still persists and printing does not restart, follow below procedure:
 1. Disconnect the cable.
 2. Turn the POWER switch of the camcorder to OFF and back to PLAY (VCR).
 3. Reconnect the cable.

○ **When you have finished printing:**

1. Disconnect the cable from the camcorder and printer.
2. Turn off the camcorder.

Selecting the Print Settings

The procedure for selecting the number of copies is common to all printers. Other print setting procedures vary depending on your printer model. Check which icon appears in the upper left corner of the camcorder screen after connecting, and refer to the relevant pages accordingly.



123



125



126

Selecting the Number of Copies

A maximum of 99 copies can be selected for one still image.



1. In the print setting menu, turn the SET dial to select  (COPIES) and press the SET dial.



2. Turn the SET dial to select the number of copies and press the SET dial.



Setting the Print Style

PAPER	PAPER SIZE	Available paper sizes vary depending on the printer model.
	PAPER TYPE	PHOTO, FAST PHOTO, DEFAULT
	PAGE LAYOUT	BORDERLESS, BORDERED, DEFAULT, 8-UP
 (date print)		ON, OFF, DEFAULT
 (print effect)		ON, OFF, VIVID, NR, VIVID+NR, DEFAULT



- Print setting options and [DEFAULT] settings vary depending on the printer model. For details, refer to the instruction manual of your printer.
- [BORDERED]: The image area remains relatively unchanged from the recorded image when it is printed. [BORDERLESS]/[8-UP]: The center portion of the recorded image is printed at an enlarged size. The image's top, bottom and sides may be cropped slightly.
- [8-UP] can be selected when using card size paper (5.3 x 8.6 cm) with CP Printers.
- Date print cannot be selected with the CP Printers CP-200 and CP-300.
- [VIVID], [VIVID+NR] and [NR] can be selected with Canon Bubble Jet Printers.
- With CP Printers, make sure to select the paper size of the attached paper cassette.

Paper Settings

1. In the print setting menu, turn the SET dial to select [PAPER] and press the SET dial.



2. Turn the SET dial to select the paper size and press the SET dial.

Select the paper size of the paper set in your printer.



3. Turn the SET dial to select the paper type and press the SET dial.

Select the paper type of the paper set in your printer.



4. Turn the SET dial to select a layout option and press the SET dial.



Including the Date in the Print

1. In the print setting menu, turn the SET dial to select ☺ (date) and press the SET dial.



2. Turn the SET dial to select a date print option and press the SET dial.



Setting the Print Effect (Image Optimize)

This function uses the camcorder's recording information to optimize the image data, yielding high quality prints.

1. In the print setting menu, turn the SET dial to select  (print effect) and press the SET dial.



2. Turn the SET dial to select a setting and press the SET dial.



Setting the Print Style

PAPER		CARD #1*, CARD #2*, CARD #3*, LTR, A4 For details on paper type, refer to the Bubble Jet Printer User Guide.
BORDERS	BORDERLESS	Prints right to the edges of the page.
	BORDERED	Prints with a border.

* Recommended paper size



[BORDERED]: The image area remains relatively unchanged from the recorded image when it is printed. [BORDERLESS]: The center portion of the recorded image is printed at an enlarged size. The image's top, bottom and sides may be cropped slightly.

1. In the print setting menu, turn the SET dial to select [STYLE] and press the SET dial.



2. Make sure that  (PAPER) is selected and press the SET dial.



3. Turn the SET dial to select the paper size and press the SET dial.

- Select the paper size of the paper set in your printer.
- Pressing the MENU button brings you back to the print settings menu.



4. Turn the SET dial to select  (BORDERS) and press the SET dial.

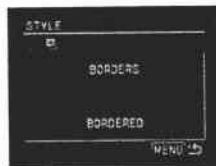

5. Turn the SET dial to select a borders option and press the SET dial.

Pressing the MENU button brings you back to the print settings menu.



Setting the Print Style

IMAGE	STANDARD	Prints 1 still image per page.
	MULTIPLE	Prints 8 copies of the same still image on one page.
BORDERS	BORDERLESS	Prints right to the edges of the page.
	BORDERED	Prints with a border.



- [BORDERED]: The image area remains relatively unchanged from the recorded image when it is printed. [BORDERLESS]/[MULTIPLE]: The center portion of the recorded image is printed at an enlarged size. The image's top, bottom and sides may be cropped slightly.
- [MULTIPLE] can only be selected when printing on card size paper.
- [BORDERS] can only be selected when [IMAGE] is set to [STANDARD].

1. In the print setting menu, turn the SET dial to select [STYLE] and press the SET dial.



Selecting the Image Style

2. Make sure that  (IMAGE) is selected and press the SET dial.

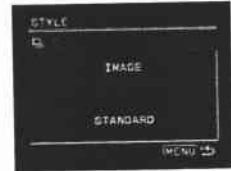

E

3. Turn the SET dial to select the image style and press the SET dial.
Pressing the MENU button brings you back to the print settings menu.

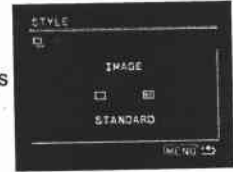

Selecting the Borders

2. Turn the SET dial to select  (BORDERS) and press the SET dial.

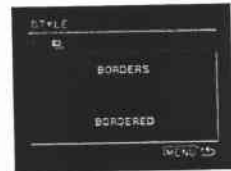

3. Turn the SET dial to select a borders option and press the SET dial.
Pressing the MENU button brings you back to the print settings menu.



Trimming Settings

Set the print style before you start with the trimming settings.

1. In the print setting menu, turn the SET dial to select [TRIMMING] and press the SET dial.

The trimming frame appears.



2. Change the size of the trimming frame.

- Move the zoom lever toward **T** to shrink the frame, and toward **W** to enlarge the frame.
- To cancel the trimming settings, move the zoom lever toward **W** until the trimming frame disappears.

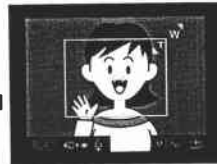

3. Move the trimming frame.

- Turn the SET dial to move the frame. Press the SET dial to switch between the directions (up/down or right/left).
- Pressing the MENU button brings you back to the print settings menu.



- About the color of the trimming frame (Canon CP-Printers only):
 - White: No trimming settings.
 - Green: Recommended trimming size. (The trimming frame may not appear in green depending on the image size, paper size or borders settings.)
 - Red: The image is magnified beyond recommended size. The image will be printed coarsely.
- The trimming setting applies only to one image.
- The trimming setting is canceled with the following operations:
 - When you turn off the camcorder.
 - When you disconnect the interface cable.
 - When you expand the trimming frame beyond its maximum size.

Printing with Print Order Settings

You can select still images for printing and set the number of copies. These print order settings are compatible with the Digital Print Order Format (DPOF) standards and can be used for printing on DPOF compatible printers (□ 119). A maximum of 200 still images can be selected.

E

Selecting Still Images for Printing (Print Order)

Do not connect a USB or DV cable to the camcorder while setting the print orders.



1. Select the still image you wish to print.
2. Press the SET dial to open the FILE OPER. menu.
3. Select [PRINT ORDR].
4. Select the number of copies.
 - "☐" appears on the image.
 - To cancel the print order, set the number of copies to 0.
5. Select [← RETURN] to close the menu.

Selecting in Index Screen Display



MENU
(□ 37)

CARD OPERATIONS

→ ☐ PRINT ORDER

1. Move the zoom lever toward **W**.
 - Up to 6 images appear.
 - Select the image you wish to print.
2. Open the menu and select [CARD OPERATIONS]. Select [→ ☐ PRINT ORDER].
3. Press the SET dial and set the number of copies with the SET dial.
 - "☐" appears on the image.
 - To cancel the print order, set the number of copies to 0.
4. Close the menu.

Direct Printing

Erasing All Print Orders



1. Open the menu and select [CARD OPERATIONS].
2. Select [PRINT ORDERS ALL ERASE].
"ERASE ALL PRINT ORDERS?", [NO] and [YES] appears.
3. Select [YES].
All "PRINT" disappear.
4. Close the menu.

Printing

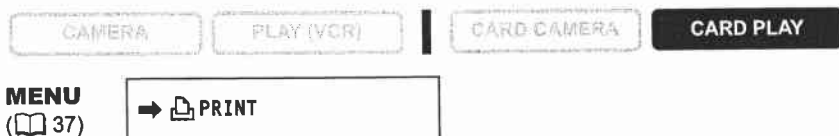

1. Connect the printer to the camcorder (119).
2. Open the menu and select [PRINT].
 - The print setting menu appears.
 - "SET PRINT ORDER" appears, when you connect a printer with direct print function and select [PRINT] without having set the print order.
3. Make sure that [PRINT] is selected and press the SET dial.
Printing starts. The print setting menu disappears when printing is complete.



- Depending on the connected printer, you can select style or paper settings before step 3.
- **Cancel Printing/Printing Errors (122)**
- **Restarting Printing**
Open the CARD PLAY menu and select [PRINT]. Select [RESUME] in the print setting menu and press the SET dial. The remaining images will be printed.
Printing cannot be restarted in the following cases:
 - When you change the print order settings.
 - When you delete a still image with print order settings.

Transferring Memory Card Images to a Computer

E

With the supplied USB cable and Digital Video Software, you can browse and archive images or arrange still images for printout. For details, refer to the *Digital Video Software Instruction Manual*.

Users of Windows OS can also transfer images to the computer by simply pressing the  (print/share) button ( 132).

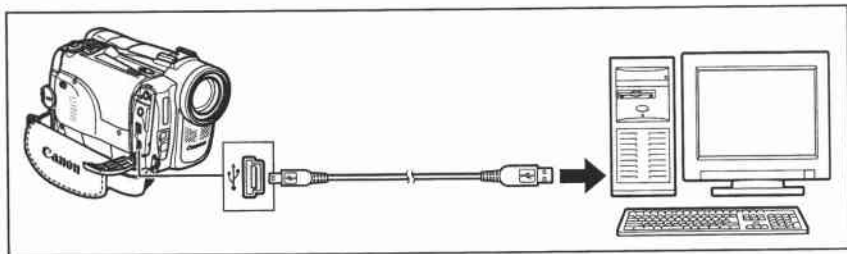





- Do not disconnect the USB cable, open the memory card cover, remove the memory card, change the position of the TAPE/CARD switch or turn off the camcorder and computer while data is being transferred to the computer (while the camcorder's card access indicator is flashing). Doing so may damage the memory card's data.
- Operation may not work correctly depending on the software and the specifications/settings of your computer.
- The image files on your memory card and the image files saved on the hard disk drive of your computer are valuable, original data files. If you wish to use image files on your computer, make copies of them first, and use the copied file, retaining the original.
- Make sure that camcorder and computer are not connected with a DV cable before connecting the camcorder to the computer using the USB cable. Otherwise, the computer may not operate properly.



- We recommend powering the camcorder from a household power source while it is connected to the computer.
- Refer also to the computer instruction manual.
- Users of Windows XP and Mac OS X:
Your camcorder is equipped with the standard Picture Transfer Protocol (PTP) allowing you to download still images (JPEG only) by simply connecting the camcorder to a computer via USB cable without installing the software from the DIGITAL VIDEO SOLUTION DISK.

Direct Transfer Windows OS only

You can transfer images to the computer with the  (print/share) button.

 ALL IMAGES...	Transfers all images to the computer.
 NEW IMAGES...	Transfers only those images that have not yet been transferred to the computer.
<input checked="" type="checkbox"/> TRANSFER ORDERS...	Transfers images with transfer orders to the computer.
 SELECT & TRANSFER...	Allows you to select an image and transfers the selected image to the computer.
 WALLPAPER...	Allows you to select a still image and transfers the selected image to the computer as wallpaper.

Preparations

The first time you connect the camcorder to the computer, you need to install the software and set the auto-launch setting.



1. Install the supplied Digital Video Software.

See *Installing the Software* in the *Digital Video Software Instruction Manual*.

2. Set the camcorder to CARD PLAY mode.

3. Connect the camcorder to the computer using the USB cable.

See *Connecting the Camcorder to a Computer* in the *Digital Video Software Instruction Manual*.

4. Set the auto-launch setting.

- See *Starting CameraWindow* in the *Digital Video Software Instruction Manual*.
- The direct transfer menu appears on the camcorder screen and the  button lights up.



From the second time on, you only need to connect the camcorder to the computer to transfer images.

Transferring All Images, New Images or Images with Transfer Orders

To transfer images with transfer order, you need to set the transfer orders (□ 135).



1. Turn the SET dial to select [ALL IMAGES], [NEW IMAGES] or [TRANSFER ORDERS].
2. Press the button.

- The images are transferred to the computer and displayed in the Main Window of ZoomBrowser EX.
- The camcorder displays the transfer menu when transfer is complete.
- To cancel transfer, turn the SET dial to select [CANCEL] and press the SET dial, or press the MENU button.



Transferring a Selected Image



1. Turn the SET dial to select [SELECT & TRANSFER].
2. Press the button.
3. Select the image you wish to transfer with the CARD+/- button.
4. Press the button.

- The selected image is transferred to the computer and displayed in the Main Window of ZoomBrowser EX.
- To continue transferring, select another image with the CARD+/- button.
- Pressing the MENU button brings you back to the transfer menu.



Transferring a Still Image as Wallpaper



1. Turn the SET dial to select [WALLPAPER].
2. Press the button.
3. Select the still image you wish to transfer as wallpaper with the CARD +/- button.
4. Press the button.

- The selected image is transferred to the computer and displayed on the desktop.
- Pressing the MENU button brings you back to the transfer menu.











E



- Do not change the operating mode while the camcorder is connected to a computer.
- Only JPEG compressed still images and Motion JPEG compressed movies can be transferred.



- You can press the SET dial in place of the  button. With [ ALL IMAGES], [ NEW IMAGES] or [ TRANSFER ORDERS], a confirmation message appears. Turn the SET dial to select [OK] and press the SET dial.
- When transferring with the  button, the camcorder retains the transfer setting even if you turn it off or change the position of the TAPE/CARD switch. When you have selected [ SELECT & TRANSFER] or [ WALLPAPER], the screen to select a still image appears. Press the MENU button to display the direct transfer menu.
- When the protect switch of the SD Memory Card is activated during image transfer, the images will not be marked as "already transferred", and will be transferred again when you select [ NEW IMAGES] later.

Selecting Images for Transfer (Transfer Order)

You can select images for transfer to the computer. These transfer settings are compatible with the Digital Print Order Format (DPOF) standards. A maximum of 200 images can be selected.

Do not connect a USB or DV cable to the camcorder while setting the transfer orders.



1. Select the image you wish to transfer.
2. Press the SET dial to open the FILE OPER. menu.
3. Select [TRANS.ORDER] and press the SET dial.
 - "" appears on the image.
 - To cancel the transfer order, press the SET dial again.
4. Select [RETURN] to close the menu.

Selecting in Index Screen Display



MENU
(37)

CARD OPERATIONS

TRANSFER ORDER

1. Move the zoom lever toward **W**.
Up to 6 images appear.
2. Open the menu and select [CARD OPERATIONS]. Select [TRANSFER ORDER].
3. Press the SET dial on the image you wish to transfer.
 - "" appears on the image.
 - To cancel the transfer order, press the SET dial again.
4. Close the menu.

Erasing All Transfer Orders



MENU
(37)

CARD OPERATIONS

TRANS.ORDERS ALL ERASE

1. Open the menu and select [CARD OPERATIONS].
2. SELECT [TRANS.ORDERS ALL ERASE].
"ERASE ALL TRANSFER ORDERS?", [NO] and [YES] appears.
3. Select [YES].
All "" disappear.
4. Close the menu.

About the NETWORK Mode (DV Messenger Version2)

With the Windows XP dedicated DV Network Software (DV Messenger), you can operate your camcorder from the computer, perform videoconferences using the camcorder or remotely access the camcorder at home using the Internet.

Download the DV Messenger and the DV Network Software Instruction Manual from the following homepage. Refer to the *DV Network Software Instruction Manual* for details.

www.canon-europe.com/DVmessenger

www.canon.com.au/products/cameras.html

www.canon.com.cn/down/static/driverlistview.html

www.canon-asia.com

Preparations

1. Install DV Messenger.
2. Connect the power adapter to the camcorder.
3. Press the UNLOCK button and turn the POWER switch to NETWORK.

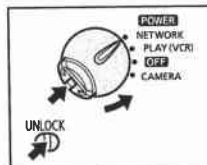

4. Connect the camcorder to the computer using a DV cable.

- "NETWORK MODE" appears on the camcorder screen.

5. Start DV Messenger.



Before connecting the camcorder to the computer using a DV cable, make sure that camcorder and computer are not connected with a USB cable, and that no other 1394 device is connected to the computer.



- In NETWORK mode, the camcorder can only be operated from the computer, except for the following functions:
 - When the DV Messenger [CAMERA] control panel is displayed: Zoom and focus (when DV Messenger set to autofocus)
 - When the DV Messenger [VCR] control panel is displayed: Volume adjustment of the built-in speaker
- Following functions cannot be used with DV Messenger.
 - Image stabilizer
 - Digital zoom
 - **MX350i/MX330i**: Flash
- The camcorder cannot be operated with the wireless controller.

Screen Displays

E

Hiding the Displays on the LCD Screen

You can hide the displays on the LCD screen to have a clear screen for playback.



Open the menu and select [DISPLAY SETUP/⊗]. Select [DISPLAYS], set it to [OFF <PLAYBK>] and close the menu.

- Warning messages still appear, and the data code appears if turned on.
- The displays appear while a playback image is magnified or a digital effect is activated.
- Tape operation displays appear for 2 seconds.
- Displays cannot be hidden on the index screen.

Hiding/Showing the Displays on the TV Screen

When you connect a TV for recording, you can select to hide the camcorder displays on the TV screen. For playback, you can show the camcorder displays on the TV screen.

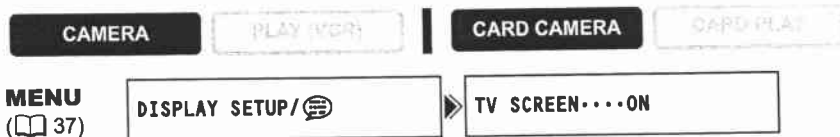

Open the menu and select [DISPLAY SETUP/⊗]. Select [TV SCREEN], set it to [OFF] and close the menu.

The displays disappear from the TV screen.



Open the menu and select [DISPLAY SETUP/⊗]. Select [TV SCREEN], set it to [ON] and close the menu.

The displays appear on the TV screen.

Screen Displays during Recording/Playback

CAMERA Mode (see also 26)

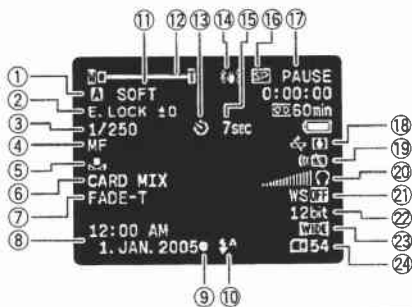

- ① Program AE (94)
- ② Exposure (51)
- ③ Shutter speed (56)
- ④ Manual focus (52)
- ⑤ White balance (54)
- ⑥ Card mix (113)
- ⑦ Digital effects (62)
- ⑧ Date and time (20)

* MVX350i/MVX330i only.

- ⑨ AF/AE locked during still image recording (94)
- ⑩ Flash* (98)
- ⑪ Skin detail (50)
- ⑫ Zoom (28)
- ⑬ Self-timer (58)
- ⑭ Image stabilizer (78)
- ⑮ Self-timer countdown (58)
- ⑯ Recording mode (59)
- ⑰ Tape operation
- ⑱ Backup battery (15) / Condensation warning (145)
- ⑲ Remote sensor (77)
- ⑳ Headphones (60)
- ㉑ Wind screen (61)
- ㉒ Audio mode (60)
- ㉓ Widescreen mode (68)
- ㉔ Remaining card capacity for still images (96)

PLAY (VCR) Mode







- ① 12 bit audio (88)
- ② End search (72) / Date search (74) / Audio dubbing (86)
- ③ Data code (70)
- ④ DV connection* (82)
- ⑤ Volume level of speaker or headphones (33)

- | | | |
|--|--|--|
| <ul style="list-style-type: none"> ⑥ REC PAUSE STOP EJECT FF REW | <ul style="list-style-type: none"> / : Fast forward playback/rewind playback (32) x2 / x2: x2 playback (32) x1 / x1: x1 playback (32) / : Slow playback (32) / : Frame advance playback/frame reverse playback (32) | <ul style="list-style-type: none"> : Playback pause (32) / : Date search (74) RTN / RTN: Zero set memory (73) / : Audio dubbing (86) |
|--|--|--|

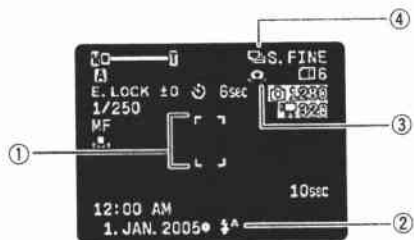
* MVX350i/MVX330i only.

CARD CAMERA Mode (see also 102)







- ① Focusing frame ( 104)
- ② Flash* ( 98)
- ③ Camcorder shake warning ( 57)
- ④ Drive mode ( 105)

E

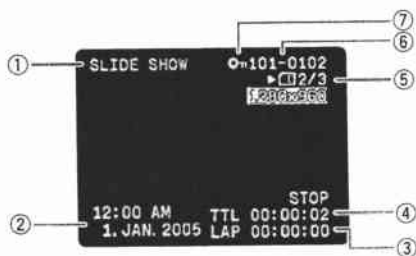
* MVX350i/MVX330i only.

CARD PLAY Mode







- ① Slide show ( 110)
- ② Data code ( 70)
- ③ Lap time
- ④ Length of the movie
- ⑤ Current image/total images
- ⑥ File number ( 93)
- ⑦ Protect mark ( 111)

List of Messages

Message	Explanation	
SET THE TIME ZONE, DATE AND TIME	You have not set the time zone, date and time. This message appears each time you turn the power on until you set the time zone, date and time.	20
CHANGE THE BATTERY PACK	Battery pack is exhausted. Replace or charge the battery pack.	11
THE TAPE IS SET FOR ERASURE PREVENTION	Cassette is protected. Replace the cassette or change the position of the protect switch.	148
REMOVE THE CASSETTE	Camcorder stopped operating to protect the tape. Unload and reload the cassette.	14
CHECK THE INPUT	DV cable or USB cable is not connected, or the connected digital device is turned off.	84
CONDENSATION HAS BEEN DETECTED	Condensation has been detected in the camcorder.	145
TAPE END	Tape reached the end. Rewind the tape or replace the cassette.	-
CHECK THE CASSETTE [REC MODE]	You attempted to perform audio dubbing on a tape recorded in a mode other than the SP mode.	86
CHECK THE CASSETTE [AUDIO MODE]	You attempted to perform audio dubbing on a tape recorded in 16-bit or 12-bit 4-channel sound.	86
CHECK THE CASSETTE [BLANK]	You attempted to perform audio dubbing on a tape with a blank section.	86
WRONG FORMAT PLAYBACK NOT POSSIBLE	You attempted to play back a tape recorded in HD format.	-
CHECK THE CASSETTE [WRONG FORMAT]	You attempted to perform audio dubbing on a tape recorded in HD format.	-
HEADS DIRTY, USE CLEANING CASSETTE	Video heads are dirty. Clean the video heads.	145
COPYRIGHT PROTECTED PLAYBACK IS RESTRICTED	You attempted to play back a copyright protected tape.	83
COPYRIGHT PROTECTED DUBBING RESTRICTED	You attempted to dub a copyright protected tape. May also appear when an anomalous signal is received during analog line-in recording, or during analog-digital conversion of a copyright protected tape.	83

Memory Card Related Messages



Message	Explanation	
NO CARD	Memory card not inserted into the camcorder.	90
THE CARD IS SET FOR ERASURE PREVENTION	SD Memory Card is set for erasure prevention. Replace the card or change the position of the protect switch.	90
NO IMAGES	No images are recorded on the memory card.	-
CARD ERROR	A memory card error occurred. The camcorder cannot record or play back the image. The error may be temporary. If the message disappears after 4 seconds and "  " flashes red, turn the camcorder off, remove the card and reinsert the card. If "  " changes to green, you can continue recording/playback.	-
CARD FULL	No remaining capacity on the memory card. Replace with another card or erase images.	-
NAMING ERROR	File or folder number has reached the maximum value.	93







Message	Explanation	
UNIDENTIFIABLE IMAGE	Image is not recorded with JPEG compression or with a compression not compatible with the camcorder, or the image file is corrupted.	-
 TRANSFER ORDER ERROR	You attempted to set more than 200 transfer orders.	135
CANNOT TRANSFER!	You attempted to transfer a movie file as wallpaper.	133
THIS IMAGE CANNOT BE RECORDED	Some analog images cannot be recorded on the memory card depending on the signal.	-
THIS IMAGE CANNOT BE USED AS START-UP IMAGE	You attempted to use an image recorded with another camcorder, recorded with a compression not compatible with this camcorder, or that has been edited on a computer.	118
TOO MANY STILL IMAGES DISCONNECT USB CABLE	Disconnect the USB cable and decrease the number of still images on the memory card to less than 1800. If a dialog appeared on the computer screen, close it. Reconnect the USB cable.	-

E

Direct Print Related Messages

Following messages may appear on the camcorder screen. On printers equipped with an operation panel or printer that can be connected to a TV, an error number or message displays on the panel or TV monitor. Refer to the printer manual for the remedies corresponding to the error numbers or messages.

Message	Explanation
PAPER ERROR	There is a problem with the paper. Wrong paper size is inserted, the ink cannot be used with the selected paper or paper output tray is open.
NO PAPER	Paper is not correctly inserted or there is no paper. If the printer is equipped with a photo paper cassette, specify the paper feed location using the Paper Feed switch.
PAPER JAM	The paper jammed during printing. Select [STOP] to cancel printing. After removing the paper, set some paper again and press the resume button on the printer.
PAPER HAS BEEN CHANGED	Paper size has been changed between print setting and start of printing.
MEDIA TYPE ERROR	You attempted to use a paper size/type that is not supported by the printer.
INCOMPATIBLE PAPER SIZE	You attempted to print on paper that cannot be used with the camcorder.
INK ERROR	There is a problem with the ink.
NO INK	The ink cartridge is not inserted or is out of ink.
LOW INK LEVEL	The ink cartridge needs to be replaced soon. Select [CONTINUE] to restart printing.
INK CASSETTE ERROR	There is a problem with the ink cassette.
PAPER AND INK DO NOT MATCH	The ink cannot be used with the selected paper type.
WASTE TANK FULL	Waste tank is full. Select [CONTINUE] to restart printing. Consult your dealer or a Canon Service Center listed in the Contact List provided with the printer or the printer manual to replace the waste tank (waste ink absorber).
FILE ERROR	You attempted to print an image that was recorded with another camcorder, with a different compression, or was edited on a computer.
CANNOT PRINT!	You attempted to print an image that was recorded with another camcorder, with a different compression, or was edited on a computer.
COULD NOT PRINT X IMAGES	You attempted to use the print order settings to print X images that were recorded with another camcorder, with a different compression or were edited on a computer.
SET  PRINT ORDER	You attempted to print an image from the CARD PLAY menu [ PRINT] without having set the print order.
 PRINT ORDER ERROR	You attempted to set more than 200 still images in the print order.
CANNOT TRIM	You attempted to trim an image that was recorded with another camcorder.
READJUST TRIMMING	You changed the print style after you set the trimming settings.
PRINTER ERROR	Cancel printing. Turn off the printer and turn it back on. Check the printer status. If the error persists, consult your dealer or a Canon Service Center listed in the Contact List provided with the printer or the printer manual.

Message	Explanation
PRINT ERROR	Cancel printing, disconnect the USB cable and turn off the printer. After a while, turn the printer back on and reconnect the USB cable. Check the printer status. If the error persists, consult your dealer or a Canon Service Center listed in the Contact List provided with the printer or the printer manual. When you are printing using the   button, check the print settings.
HARDWARE ERROR	Cancel printing. Turn off the printer and turn it back on. Check the printer status. If the printer is equipped with a battery, it might be exhausted. In such case, turn off the printer, replace the battery and turn it back on. If the error persists, consult your dealer or a Canon Service Center listed in the Contact List provided with the printer or the printer manual.
RECHARGE THE PRINTER BATTERY	The printer battery is depleted.
COMMUNICATION ERROR	The printer is experiencing a data transmission error. Cancel printing, disconnect the USB cable and turn off the printer. After a while, turn the printer back on and reconnect the USB cable. When you are printing using the   button, check the print settings. Or, you attempted to print from a memory card that contains a large number of images. Reduce the number of images.
CHECK PRINT SETTINGS	The print setting cannot be used for printing with the   button.
PRINTER IN USE	The printer is in use. Check the printer status.
PRINTER WARMING UP	Printer is warming up. If the message does not disappear after a few seconds, check the printer status.
PAPER LEVER ERROR	Paper lever error occurred. Adjust the paper selection lever to the proper position.
PRINTER COVER OPEN	Close the printer cover securely.
NO PRINthead	No print head is installed in the printer or print head is defect. Refer to the instruction manual of your printer.

Maintenance/Others

Camcorder Handling Precautions

- Do not carry the camcorder by the LCD panel or viewfinder.
- Do not leave the camcorder in places subject to high temperatures, such as a sun-heated car, and high humidity.
- Do not use the camcorder near strong electric or magnetic fields such as above TVs, near plasma TVs or mobile phones.
- Do not point the lens or viewfinder at strong light sources. Do not leave the camcorder pointed at a bright subject.
- Do not use the camcorder in dusty or sandy places. Dust or sand getting inside the cassette or camcorder may cause damage. Dust and sand can also damage the lens. Attach the lens cap after use.
- The camcorder is not waterproof. Water, mud or salt getting inside the cassette or camcorder may cause damage.
- Be careful of heat generated by lighting equipment.
- Do not disassemble the camcorder. If the camcorder does not function properly, consult qualified service personnel.
- Handle the camcorder with care. Do not subject the camcorder to shocks or vibration as this may cause damage.
- Avoid sudden changes in temperature. Moving the camcorder rapidly between hot and cold temperatures may cause condensation to form on its internal surfaces (□ 145).

Storage

- If you do not intend to use the camcorder for a long time, store it in a place free of dust, in low humidity, and at temperatures not higher than 30 °C (86 °F).
- After storage, check the functions of your camcorder to make sure that the camcorder is still working properly.

Cleaning

Camcorder Body and Lens

- Use a soft, dry cloth to clean the camcorder body and lens. Never use chemically treated cloth or volatile solvents such as paint thinner.

LCD Screen

- Clean the LCD screen using a commercially available cleaning cloth for glasses.
- Condensation may form on the surface of the screen when the temperature changes suddenly. Wipe it with a soft dry cloth.
- At cold temperatures, the screen may be darker than usual. This is not a malfunction. The screen returns to normal when the camcorder warms up.

Viewfinder

- Clean the viewfinder screen using a blower brush or a commercially available cleaning cloth for glasses.

Video Heads

- When the message "HEADS DIRTY, USE CLEANING CASSETTE" appears, or when the playback picture becomes distorted, the video heads need to be cleaned.
- To maintain the best picture quality, we recommend cleaning the video heads frequently with the Canon DVM-CL Digital Video Head Cleaning Cassette or a commercially available dry cleaning cassette.
- Tapes already recorded with dirty video heads may not be played back correctly even when you clean the video heads.
- Do not use wet type cleaning cassettes as this may damage the camcorder.



Condensation

Moving the camcorder rapidly between hot and cold temperature may cause condensation (water droplets) to form on its internal surfaces. Stop using the camcorder if condensation is detected. Continued use may damage the camcorder.

Condensation may form in the following cases:

When the camcorder is moved from an air-conditioned room to warm, humid place

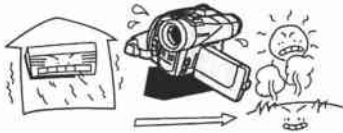

When the camcorder is moved from a cold place to a warm room



When the camcorder is left in a humid room



When a cold room is heated rapidly



How to avoid condensation:

- Unload the cassette, place the camcorder in an airtight plastic bag and let it adjust to temperature changes slowly before removing it from the bag.

When condensation is detected:

- The camcorder stops operating and the warning message "CONDENSATION HAS BEEN DETECTED" appears for approx. 4 seconds and "⏏" starts flashing.
- If a cassette is loaded, the warning message "REMOVE THE CASSETTE" appears and "⏏" starts flashing. Remove the cassette immediately and leave the cassette compartment open. Leaving the cassette in the camcorder may damage the tape.
- A cassette cannot be loaded when condensation is detected.

Resuming use:

- It takes about 1 hour until the water droplets evaporate. After the condensation warning stops flashing, wait for 1 more hour before resuming use.

Battery Pack Handling Precautions

DANGER!

Treat the battery pack with care.

- Keep it away from fire (or it might explode).
- Do not expose the battery pack to temperature higher than 60 °C (140 °F). Do not leave it near a heater or inside a car in hot weather.
- Do not try to disassemble or modify it.
- Do not drop or knock it.
- Do not get it wet.

- Charged battery packs continue to discharge naturally. Therefore, charge them on the day of use, or the day before, to ensure a full charge.
- Attach the terminal cover whenever a battery pack is not in use. Contact to metallic objects may cause a short circuit and damage the battery pack.
- Dirty terminals may cause a poor contact between the battery pack and the camcorder. Wipe the terminals with a soft cloth.
- Since storing a charged battery pack for a long time (about 1 year) can shorten its lifecycle or affect performance, we recommend to discharge the battery pack fully and to store it in a dry place at temperatures no higher than 30 °C (86 °F). If you do not use the battery pack for long periods, charge and discharge it fully at least once a year. If you have more than 1 battery pack, perform these precautions at the same time for all battery packs.
- Replace the battery pack if the usable time after full charge diminishes substantially at normal temperatures.
- Although the battery pack's operating temperature range is from 0 °C to 40 °C (32 °F to 104 °F), the optimal range is from 10 °C to 30 °C (56 °F to 86 °F). At cold temperatures, performance will temporarily decline. Warm it in your pocket before use.

About the battery terminal cover

The battery terminal cover has a []-shaped hole. This is useful when you wish to differentiate between charged and uncharged battery packs. For example, with charged battery packs, attach the terminal cover so that the []-shaped hole shows the blue label.

Back side of the battery pack

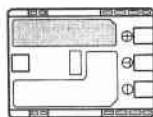

Terminal cover attached
Charged



Uncharged



Lithium Button Battery Handling Precautions

WARNING!

- The battery used in this device may present a fire or chemical burn hazard if mistreated. Do not recharge, disassemble, heat above 100 °C (212°F) or incinerate the battery.

CR1616:

- Replace the battery with a CR1616 made by Panasonic, Hitachi Maxell, Sony, Toshiba, Varta or Renata. Use of other batteries may present a risk of fire or explosion.

CR2025:

- Replace the battery with a CR2025 made by Panasonic, Hitachi Maxell, Sony, Sanyo, or with Duracell2025. Use of other batteries may present a risk of fire or explosion.
- The used battery should be returned to the supplier for safe disposal.

- Do not pick up the battery using tweezers or other metal tools as this will cause a short circuit.
- Wipe the battery with a clean dry cloth to ensure proper contact.
- Keep the battery out of reach of children. If it is swallowed, seek medical assistance immediately. The battery case may break and the battery fluids may damage stomach and intestines.
- Do not disassemble, heat or immerse the battery in water to avoid the risk of explosion.

Cassette Handling Precautions

- Rewind tapes after use. If the tape becomes slack and damaged, it may cause picture and sound distortion.
- Return cassettes in the case and store them upright.
- Do not leave the cassette in the camcorder after use.
- Do not use spliced tapes or nonstandard cassettes as they may damage the camcorder.
- Do not use tapes that have been jammed as video heads may become dirty.
- Do not insert anything into the small holes of the cassette, or cover them with cellophane tape.
- Handle cassettes with care. Do not drop or subject them to severe impact as this may damage the cassettes.
- Rewind tapes from time to time if they are stored for a long time.
- With cassettes equipped with a memory function, metal plated terminals may become dirty with use. Clean the terminals with a cotton swab after about 10 times of loading/unloading. The memory function is not supported by the camcorder.

E

Protecting Tapes from Accidental Erasure

To protect your recordings from accidental erasure, slide the tab on the cassette to SAVE or ERASE OFF.

If you load a protected cassette in CAMERA mode, the message "THE TAPE IS SET FOR ERASURE PREVENTION" appears for approx. 4 seconds and "⊞" starts flashing. If you wish to record on that cassette, change the position of the tab.

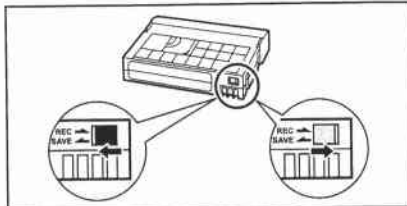

Memory Card Handling Precautions

- Format new memory cards with the camcorder. Memory cards formatted with other devices such as a computer may not operate correctly.
- We recommend saving backups of memory card images on your computer's hard drive or other external memory device. Image data may be corrupted or lost due to memory card defects or exposure to static electricity. Canon Inc. makes no warranties for corrupted or lost data.
- Do not turn off the camcorder, disconnect the power source, open the memory card cover or remove the memory card while the card access indicator is flashing.
- Do not use memory cards in places subject to strong magnetic fields.
- Do not leave memory cards in places subject to high humidity and high temperature.
- Do not disassemble memory cards.
- Do not bend, drop, or subject memory cards to shocks and do not expose them to water.
- Moving a memory card rapidly between hot and cold temperatures may cause condensation to form on its external and internal surfaces. If condensation forms on the card, put it aside until the droplets have evaporated completely.
- Do not touch or expose the terminals to dust or dirt.
- Check the direction before inserting the memory card. Forcing a memory card backwards into the slot may damage the memory card or the camcorder.
- Do not remove the label from the memory card, or affix other labels on the memory card.

Using the Camcorder Abroad

Power Sources

You can use the compact power adapter to operate the camcorder and to charge battery packs in any country with power supply between 100 and 240 V AC, 50/60 Hz. Consult the Canon Service Center for information on plug adapters for overseas use.

E

Playback on a TV Screen

You can only play back your recordings on TVs with PAL system. The PAL system is used in the following countries/areas:

Algeria, Australia, Austria, Bangladesh, Belgium, Brunei, China, Denmark, Finland, Germany, Hong Kong Special Administrative Region, Iceland, India, Indonesia, Ireland, Italy, Jordan, Kenya, Kuwait, Liberia, Malaysia, Malta, Mozambique, the Netherlands, New Zealand, North Korea, Norway, Oman, Pakistan, Portugal, Qatar, Sierra Leone, Singapore, South Africa, Spain, Sri Lanka, Swaziland, Sweden, Switzerland, Tanzania, Thailand, Turkey, Uganda, United Arab Emirates, United Kingdom, Yemen, former Yugoslavia, Zambia.





Troubleshooting

If you have a problem with your camcorder, refer to this checklist. Consult your dealer or a Canon Service Center if the problem persists.

Power Source

Problem	Cause	Solution	□
Camcorder will not turn on.	Battery pack is exhausted.	Replace or charge the battery pack.	11
	Battery pack is not correctly attached.	Attach the battery pack correctly.	11
The camcorder switches off by itself.	Battery pack is exhausted.	Replace or charge the battery pack.	11
	Power save function has been activated.	Turn on the camcorder.	23
Cassette compartment will not open.	Battery pack is exhausted.	Replace or charge the battery pack.	11
	Cassette compartment cover is not fully open.	Open the cassette compartment cover fully.	14
Cassette compartment stopped during loading/unloading.	Battery pack is exhausted.	Replace or charge the battery pack.	11
LCD/viewfinder switches on and off.	Battery pack is exhausted.	Replace or charge the battery pack.	11
Battery pack will not charge.	Battery packs will not charge outside the temperature range of 0 °C and 40°C (32°F and 104°F).	Charge the battery pack in temperatures between 0 °C and 40 °C (32°F and 104°F).	—
	Battery packs become hot with use and may not charge.	Wait until the battery pack temperature is below 40 °C (104 °F) and retry charging.	—
	The battery pack is damaged.	Use a different battery pack.	—









Recording/Playback

Problem	Cause	Solution	□
Buttons will not work.	Camcorder is not turned on.	Turn on the camcorder.	23
	Cassette is not loaded.	Load a cassette.	14
"  flashes on the screen.	Cassette is not loaded.	Load a cassette.	14
"  flashes on the screen.	Battery pack is exhausted.	Replace or charge the battery pack.	11
"  flashes on the screen.	Condensation is detected.	See reference page.	145
"REMOVE THE CASSETTE" appears on the screen.	Camcorder stopped operating to protect the tape.	Unload and reload the cassette.	14
The wireless controller will not work.	[WL.REMOTE] is set to [OFF  <td>Set [WL.REMOTE] to [ON] in the menu.</td> <td>77</td>	Set [WL.REMOTE] to [ON] in the menu.	77
	The battery of the wireless controller is exhausted.	Replace the battery.	18



Recording

Problem	Cause	Solution	📖
"🔴" flashes red on the screen.	The camcorder malfunctions.	Consult a Canon Service Center.	-
Image will not appear on the screen.	Camcorder is not set to CAMERA mode.	Set the camcorder to CAMERA mode.	23
"SET THE TIME ZONE, DATE AND TIME" appears on the screen.	Time zone, date and time are not set.	Set the time zone, date and time.	20
	Backup battery is exhausted.	Replace the backup battery and reset the time zone, date and time.	15
	Battery pack is inserted the wrong way.	Insert the backup battery with the + side facing outward and set the time zone, date and time.	15
Pressing the start/stop button will not start recording.	Camcorder is turned off.	Turn on the power.	23
	Cassette is not loaded.	Load a cassette.	14
	Tape reached the end ("END" flashes on the screen).	Rewind the tape or replace the cassette.	14
	Cassette is protected ("🔒" flashes on the screen).	Change the position of the protect switch.	148
	Camcorder is set to a mode other than the CAMERA mode.	Set the camcorder to CAMERA mode.	23
Camcorder will not focus.	Autofocus does not work on that subject.	Focus manually.	52
	Viewfinder is not adjusted.	Adjust the viewfinder with the dioptic adjustment lever.	16
	Lens is dirty.	Clean the lens.	145
A vertical light bar appears on the screen.	Bright light in a dark scene may cause a vertical light bar (smear) to appear. This is not a malfunction.	---	-
Viewfinder picture is blurred.	Viewfinder is not adjusted.	Adjust the viewfinder with the dioptic adjustment lever.	16
Sound is distorted or recorded in a lower volume than the actual volume.	When recording near loud sound (such as fireworks, drums or concerts), sound may become distorted or may not be recorded in the actual sound level. This is not a malfunction.	---	-



Playback

Problem	Cause	Solution	
Pressing the playback button does not start playback.	Camcorder is turned off, or is not set to PLAY (VCR) mode.	Set the camcorder to PLAY (VCR) mode.	31
	The TAPE/CARD switch is set to CARD.	Set the TAPE/CARD switch to TAPE.	31
	Cassette is not loaded.	Load a cassette.	14
	Tape reached the end ("END" flashes on the screen).	Rewind the tape.	31
Image will not appear on the TV screen.	[AV/PHONES ] is set to [PHONES ] in the menu.	Set [AV/PHONES ] to [AV] in the menu.	34
	[AV  DV] is set to [ON] in the menu.	Set [AV  DV] to [OFF] in the menu.	85
Tape is running, but image will not appear on the TV screen.	TV/VIDEO selector on the TV is not set to VIDEO.	Set the selector to VIDEO.	34
	Video heads are dirty.	Clean the video heads.	145
	You attempted to play back or dub copyright protected tape.	Stop playback/dubbing.	-
No sound from the built-in speaker.	Speaker volume is turned off.	Adjust the volume with the SET dial.	33
Noise comes out of the headphones.	[AV/PHONES ] is set to [AV] in the menu.	Set [AV/PHONES ] to [PHONES ] in the menu.	33

Editing

Problem	Cause	Solution	
Dubbing via the camcorder's DV terminal does not work.	[AV  DV] is set to [ON] in the menu.	Set [AV  DV] to [OFF] in the menu.	85
	Wrong signal format.	Dubbing may work via the AV terminal. Refer also to the instruction manual of the connected device.	-

Memory Card Operation

Problem	Cause	Solution	
Memory card cannot be inserted.	Memory card was not facing the correct direction.	Turn the memory card over and reinsert it.	90
Memory card cannot be recorded.	Memory card is full.	Replace the memory card or erase images.	90
	Memory card is not formatted.	Format the memory card.	117
	Memory card is not inserted.	Insert a memory card.	90
	File number reached maximum value.	Set [FILE NOS.] to [RESET] in the menu and insert a new memory card.	93
	SD Memory Card is protected.	Change the position of the protect switch.	90
Memory card cannot be played back.	Camcorder is not set to CARD PLAY mode.	Set the camcorder to CARD PLAY mode.	109
	Memory card is not inserted.	Insert a memory card.	90
Image cannot be erased.	Image is protected.	Cancel the protection.	111
	SD memory card is protected.	Change the position of the protect switch.	90
"  " flashes red.	Card error occurred.	Turn off the camcorder. Remove and reinsert the memory card. Format the memory card if flashing persists.	117

Printing

Problem	Cause	Solution	
The printer is not operating even though camcorder and printer are correctly connected.	The camcorder is set to NETWORK mode.	<ol style="list-style-type: none"> 1. Set the camcorder to CARD PLAY mode. 2. Disconnect and reconnect the USB cable. 3. Turn off the printer and turn it back on. 	-

System Diagram (Availability differs from area to area)

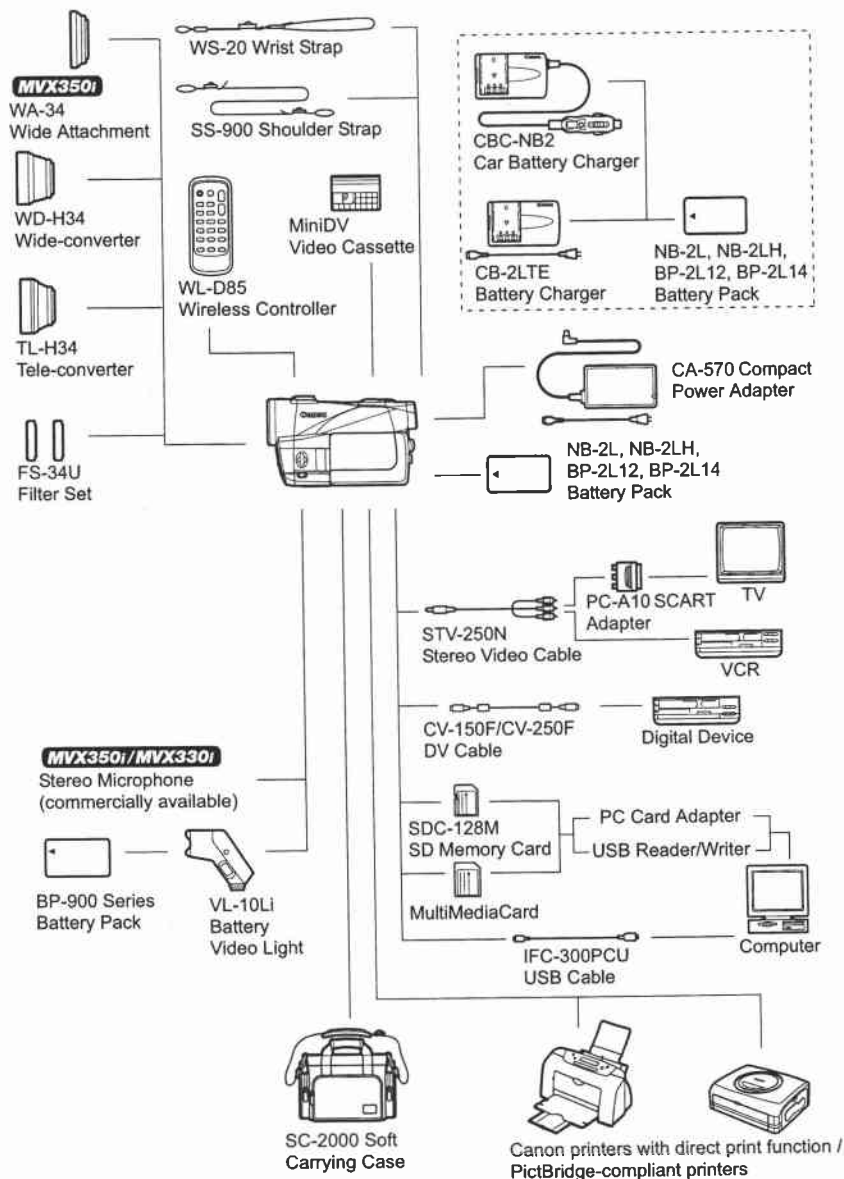

Optional Accessories

Use of genuine Canon accessories is recommended.

This product is designed to achieve excellent performance when used with genuine Canon accessories. Canon shall not be liable for any damage to this product and/or accidents such as fire, etc., caused by the malfunction of non-genuine Canon accessories (e.g., a leakage and/or explosion of a battery pack). Please note that this warranty does not apply to repairs arising out of the malfunction of non-genuine Canon accessories, although you may request such repairs on a chargeable basis.

Battery Packs

When you need extra battery packs, select from the following: NB-2L, NB-2LH, BP-2L12, BP-2L14.

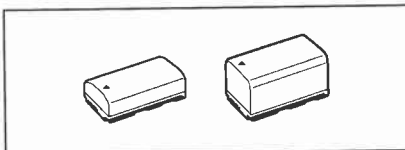

CB-2LTE Battery Charger

Use the battery charger for charging the battery packs.

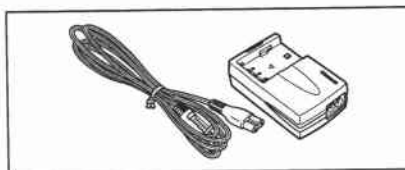

Battery Pack	Charging Time
NB-2LH	90 min.
NB-2L	80 min.
BP-2L12	150 min.
BP-2L14	170 min.

Charging time varies according to the charging condition.

CBC-NB2 Car Battery Charger

Use the car battery charger to charge battery packs on the move. The car battery cable plugs into your car's cigarette lighter and runs off a 12-24 V DC negative ground battery.

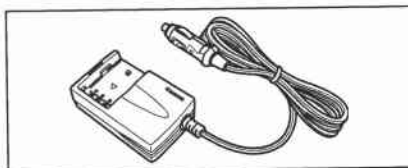

TL-H34 Tele-converter

This Tele-converter lens increases the focal length of the camcorder lens by a factor of 1.5.

- The image stabilizer is not as effective when the Tele-converter is attached.
- The minimum focusing distance with the TL-H34 is 2.5 m (8.2 ft.); 2.5 cm (0.98 in.) at maximum wide angle.
- **MVX350/MVX330** When the Tele-converter is attached, a shadow may appear in the picture when you record with flash or assist lamp.

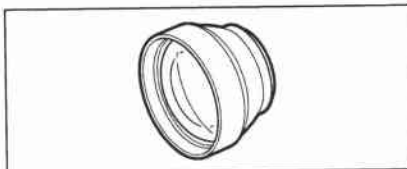

WD-H34 Wide-converter

This lens decreases focal length by a factor of 0.7, giving you a wide perspective for indoor shots or panoramic views.

- **MX350i/MX330i** When the Wide-converter is attached, a shadow may appear in the picture when you record with flash or assist lamp.

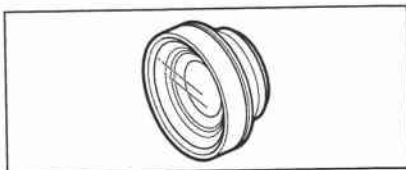

FS-34U Filter Set

Neutral density and MC protector filters help you to control difficult lighting conditions.

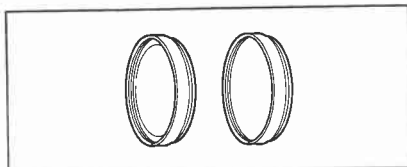

VL-10Li Battery Video Light

This compact yet powerful video light can be used for both indoor and outdoor shooting. It attaches to the SA-1 Adapter Bracket and is powered by BP-900 series battery packs.

- Approximate usage time: BP-915: 60 min., BP-930: 120 min., BP-945: 170 min.
- BP-900 series battery packs are charged with the CA-920 Compact Power Adapter or CH-910 Dual Battery Charger/Holder.

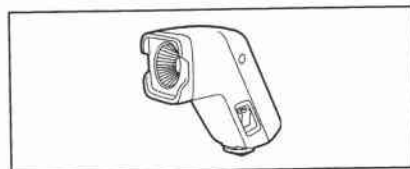

WS-20 Wrist Strap

Use this for extra additional protection for active shooting.

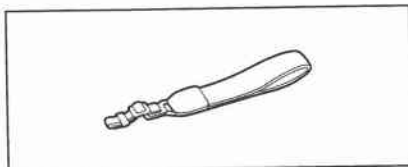

SC-2000 Soft Carrying Case

A handy camcorder bag with padded compartments and plenty of space for accessories.

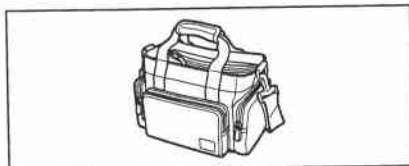

This mark identifies genuine Canon video accessories. When you use Canon video equipment, we recommend Canon-brand accessories or products bearing the same mark.



Specifications

E

MVX350i/MVX330i/MVX300

System

Video Recording System	2 rotary heads, helical scanning DV system (consumer digital VCR SD system), digital component recording
Audio Recording System	PCM digital sound: 16 bit (48 kHz/2 ch); 12 bit (32 kHz/4 ch)
Television System	CCIR standard (625 lines, 50 fields) PAL colour signal
Image Sensor	1/4.5-inch CCD, approx. 1,330,000 pixels Effective pixels: tape: approx. 860,000 pixels card: approx. 1,230,000 pixels
Tape Format	Videocassettes bearing the "MiniDV" mark.
Tape Speed	SP: 18.83 mm/s, LP: 12.57 mm/s
Maximum Recording Time (80 min. cassette)	SP: 80 min., LP: 120 min.
Fast Forward/Rewind Time	Approx. 2 min. 20 sec. (with a 60 min. cassette)
LCD Screen	2.5-inch. TFT color, approx. 123,000 pixels
Viewfinder	0.33-inch. TFT color, approx. 113,000 pixels
Microphone	Stereo electret condenser microphone
Lens	MVX350i: f=3.5-70 mm, f/1.8-3.5, 20x power zoom 35mm equivalent: Tape: 4:3 recording: 45.4-908 mm 16:9 recording (image stabilizer ON): 44.6-892 mm 16:9 recording (image stabilizer OFF): 41.3-826 mm Card: 37.9-758 mm MVX330i/MVX300: f=3.5-63 mm, f/1.8-3.4, 18x power zoom 35mm equivalent: Tape: 4:3 recording: 45.4-817 mm 16:9 recording (image stabilizer ON): 44.6-803 mm 16:9 recording (image stabilizer OFF): 41.3-743 mm Card: 37.9-682 mm
Lens Configuration	10 elements in 8 groups
Filter Diameter	34 mm
AF System	TTL autofocus, manual focusing possible
Minimum Focusing Distance	1 m (3.3 ft.); 1 cm (0.39 in.) on maximum wide angle
White Balance	Auto white balance, pre-set white balance (indoor, outdoor) or custom white balance
Minimum Illumination	1.5 lx (using the Night mode)
Recommended Illumination	More than 100 lx
Image Stabilization	Electronic

Memory Card

Recording Media	SD Memory Card, MultiMediaCard
Number of Recording Pixels	Still image: 1280 x 960, 640 x 480 pixels Movie: 320 x 240, 160 x 120 pixels, 12.5 frames/sec.
File Format	Design rule for Camera File System (DCF), Exif 2.2* compliant, DPOF compliant
Image Compression Method	Still image: JPEG (compression: Super Fine, Fine, Normal) Movie: Video data: Motion JPEG, Audio data: WAVE (monaural)

* This camcorder supports Exif 2.2 (also called "Exif Print"). Exif Print is a standard for enhancing the communication between camcorders and printers. By connecting to an Exif Print-compliant printer, the camcorder's image data at the time of shooting is used and optimized, yielding extremely high quality prints.

Additional
Information

Input/Output Terminals

AV Terminal	Ø3.5 mm minijack Video: 1 Vp-p/75 ohms unbalanced Audio output: -10 dBV (47 kohm load)/3 kohms or less Audio input: -10 dBV/40 kohms or more
DV Terminal	Special 4-pin connector (IEEE 1394 compliant)
MIC Terminal (MVX350i/MVX330i)	Ø3.5 mm stereo mini-jack -57 dBV (with 600 ohm mic)/5 kohms or more
Headphone Terminal	Ø3.5 mm stereo mini-jack
USB Terminal	mini-B

Power/Others

Power supply (rated)	7.4 V DC
Power consumption (AF on)	2.6W (using viewfinder), 3.2W (using LCD screen normal brightness)
Operating temperature	0 - 40 °C (32 - 104 °F)
Dimensions (W x H x D)	72 x 78 x 131 mm (2.8 x 3.1 x 5.2 in.) excluding protrusions
Weight (camcorder body only)	500 g (1.1 lb.)

CA-570 Compact Power Adapter

Power supply	100 - 240 V AC, 50/60 Hz
Power consumption	17W
Rated output	8.4 V DC, 1.5 A
Operating temperature	0 - 40 °C (32 - 104°F)
Dimensions	52 x 90 x 29 mm (2.1 x 3.5 x 1.1 in.)
Weight	135 g (4.8 oz.)

NB-2LH Battery Pack

Battery type	Rechargeable Lithium Ion Battery
Rated voltage	7.4 V DC
Operating temperature	0 - 40 °C (32 - 104°F)
Battery capacity	720 mAh
Dimensions	33.3 x 16.2 x 45.2 mm (1.3 x 0.64 x 1.8 in.)
Weight	43 g (1.5 oz.)

SDC-8M SD Memory Card

Capacity	8 MB
Interface	SD Memory Card standard
Operating temperature	0 - 40 °C (32 - 104°F)
Dimensions	32 x 24 x 2.1 mm (1.3 x 0.94 x 0.08 in.)
Weight	2 g (0.07 oz.)

Weight and dimensions are approximate. Errors and omissions excepted. Subject to change without notice.

Index

12bit audio	88
16:9 widescreen	68
6-second auto date	71

A

Abroad, using the camcorder	149
Accessories	6, 155
AF-assist lamp	99
Analog line-in	81
Analog-digital converter	84
Assist lamp	48
Audio dubbing	86
Audio mode	60
Auto	45
Auto Exposure Bracketing	106
Autofocus	52
AV/headphones terminal	33, 34
AV-DV	84

B

Backlight	19
Backup battery	15
Battery charger	155
Battery pack	11
Beep	77
Brightness	77

C

Card jump	110
Card mix	113
Computer	89, 131
Condensation	145
Connections - TV, VCR	34
Continuous shooting	105
Copyright signals	83

D

Data code	70
Date and time	20
Date format	76
Date search	74
Demo mode	78
Digital effects	62
Digital zoom	29
Direct print function	119
Direct transfer	132
Drive mode	105

DV dubbing	82
DV terminal	79, 89

E

Easy recording	45
Effects	63
End search	72
Erasing images	112
Exposure	51

F

Faders	62
Fast forward	32
File numbers	93
Flash	98
Focusing	52
Focusing point	104
Focus-Priority	104
Formatting	117

G

Grip belt	16
-----------	----

H

Headphones	33, 60
------------	--------

I

Image quality	91
Image stabilizer	78
Index screen	110
Infinity focus	53

L

Language	76
LCD Backlight	19
LCD mirror mode	25
LCD screen	19
Lens cap	16
Low light mode	45
LP mode	59

M

Maintenance	144
Manual focus	52
Memory card	90
Menus	37

E

MIC terminal	61
Microphone	61
Mini video light	48
Movie size	92
Multi-image screen	63
MultiMediaCard	90
My Camera settings	75

N

ND filter	95
NETWORK Mode	136
Night mode	48
Night+ mode	48

O

Operating Mode	3
Output channel	36

P

Playback - Memory card	109
Playback pause	32
Playback- Tape	31
Portrait mode	45
Power adapter	11
Print order	129
Program AE	45
Protect	111

R

Record review	27
Record search	27
Recording movies (memory card)	101
Recording movies (tape)	23
Recording programs	45
Recording still images (memory card)	94
Remote sensor	77
Review	100
Rewind	31

S

Sample images	115
Sand & Snow mode	45
Screen displays	137
SD Memory Card	90
Self-timer	58
Shoulder strap	17
Shutter speed	56
Skin detail	50
Slide show	110

SP mode	59
Speaker	33
Sports mode	45
Spotlight mode	45
Still image quality	91
Still image size	91
Stitch Assist mode	107
Super Night mode	48

T

Tape protection	148
Time code	26
Time zone	20
Transfer order	135
Tripod	30
Troubleshooting	150
TV Screen	137

U

USB terminal	119, 131
--------------	----------

V

Video heads	145
Video light	156
Videocassettes	14
Viewfinder	16

W

White balance	54
Wide attachment	17
Widescreen	68
Wind screen	61
Wireless controller	18

Z

Zero set memory	73
Zooming	28

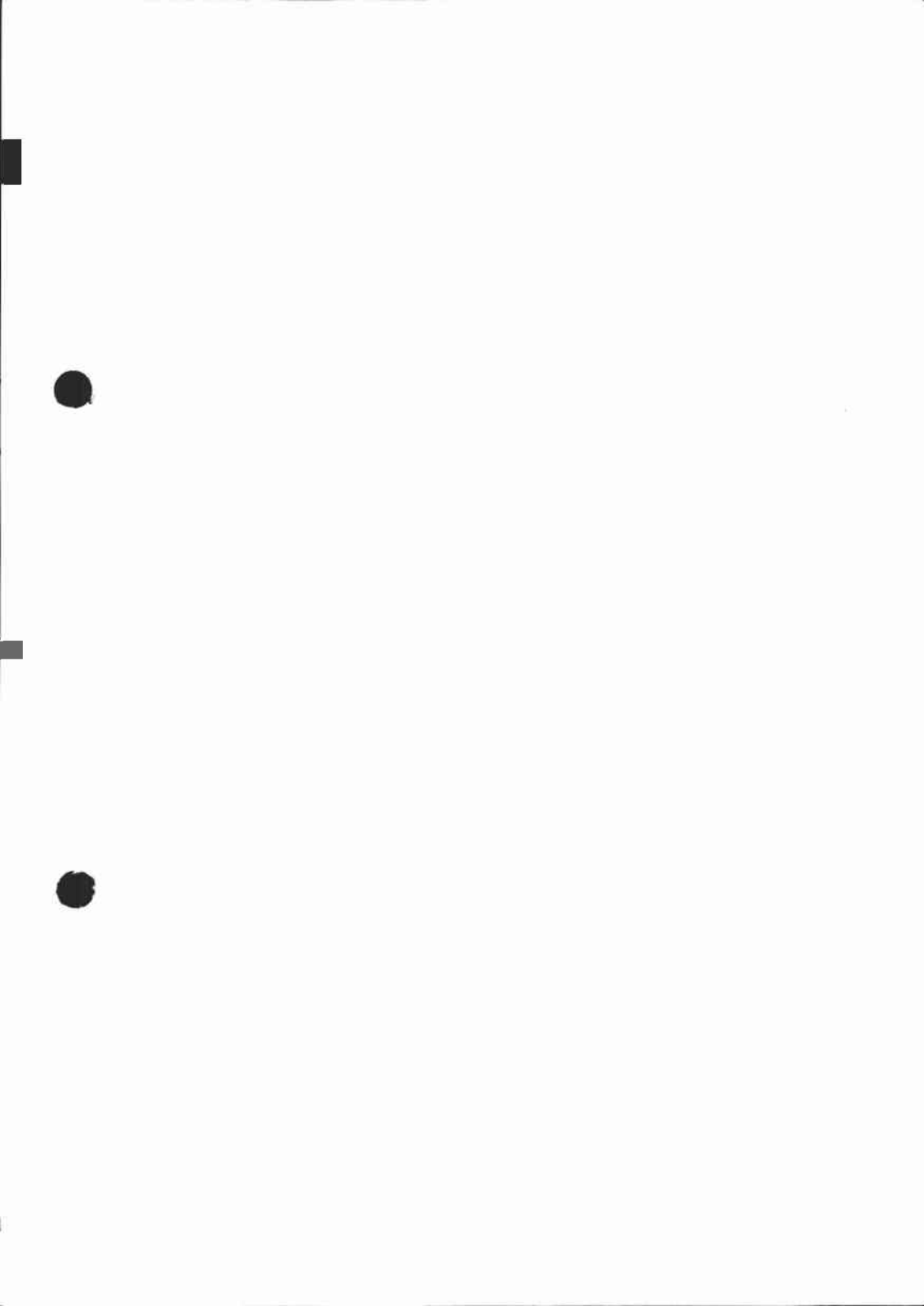

Canon

CANON INC.

Canon Europa N.V.

P.O. Box 2262, 1180 EG Amstelveen, the Netherlands

Canon UK Ltd.

CCI Service Centre, Unit 130

Centennial Park, Borehamwood, Hertfordshire, WD6 3SE, England

Telephone 0870-241-2161

Canon Australia Pty. Ltd.

Info-Line: 131383

www.canon.com.au

Canon New Zealand Ltd.

Customer Care: (09) 489 0470

www.canon.co.nz

Canon Singapore Pte. Ltd

1 HarbourFront Avenue, #04-01 Keppel Bay Tower, Singapore 098632

Tel: (65) 6799 8888

Fax: (65) 6799 8882

Canon Hongkong Company Ltd

19/F., The Metropolis Tower, 10 Metropolis Drive, Hunghom, Kowloon, Hong Kong

Canon Latin America, Inc.

Sales & Enquiries: 703 Waterford Way Suite 400 Miami, FL 33126 USA



Printed on 100% reused paper.

Free Manuals Download Website

<http://myh66.com>

<http://usermanuals.us>

<http://www.somanuals.com>

<http://www.4manuals.cc>

<http://www.manual-lib.com>

<http://www.404manual.com>

<http://www.luxmanual.com>

<http://aubethermostatmanual.com>

Golf course search by state

<http://golfingnear.com>

Email search by domain

<http://emailbydomain.com>

Auto manuals search

<http://auto.somanuals.com>

TV manuals search

<http://tv.somanuals.com>