

PIXMA

MP780/MP750

Quick Start Guide

Table of Contents

Introduction	19
Document Handling	26
Paper Handling	29
Copying	32
Photo Printing Directly From A Digital Camera	33
Preparing Your Machine For Fax	34
Sending Faxes	41
Receiving Faxes	42
Maintenance	44

Copyright

This manual is copyrighted by Canon U.S.A., Inc. with all rights reserved.

Under the copyright laws, this manual may not be reproduced in any form, in whole or in part, without the prior written consent of Canon U.S.A., Inc.

© 2004 Canon U.S.A., Inc.

Disclaimer

Canon U.S.A., Inc. has reviewed this manual thoroughly in order that it will be an easy-to-use guide to your Canon MP780/750 Series. All statements, technical information and recommendations in this manual and in any guides or related documents are believed reliable, but the accuracy and completeness thereof are not guaranteed or warranted, and they are not intended to be, nor should they be understood to be, representation or warranties concerning the products described.

Specifications are subject to change without notice.



As an ENERGY STAR partner, Canon U.S.A., Inc., has determined that this product meets the ENERGY STAR guidelines for energy efficiency.

All information regarding non-Canon products was compiled from publicly available information. No representation is made regarding the accuracy thereof.



Super G3 is a phrase used to describe the new generation of fax machines that use ITU-T V.34 standard 33.6 Kbps* modems. Super G3 High Speed Fax machines allow transmission time of approximately 3 seconds* per page which results in reduced telephone line charges.

* Approximately 3 seconds per page fax transmission time based on ITU-T No. 1 Chart (Standard Mode) at 33.6 Kbps modem speed. The Public Switched Telephone Network currently supports fax modem speeds of 28.8 Kbps or lower, depending on telephone line conditions. Sending and receiving fax machines need to conform to ITU-T V.34 guidelines.



This machine supports Exif 2.2 (also called “Exif Print”). Exif Print is a standard for enhancing the communication between digital cameras and printers. By connecting to an Exif Print-compliant digital camera, the camera’s image data at the time of shooting is used and optimized, yielding extremely high quality prints.

Trademarks

- Canon is a registered trademark.
- PIXMA is a trademark of Canon Inc.
- Microsoft® and Windows® are registered trademarks of Microsoft Corporation in the U.S. and other countries.
- Macintosh, Mac and the Mac logo are registered trademarks of Apple Computer, Inc., registered in the U.S. and other countries.
- All other product and brand names are registered trademarks or trademarks of their respective owners.

► How To Use The Documentation Provided

Easy Setup Instructions (Printed documentation):

Be sure to read this sheet first.

This sheet includes instructions for setting up your machine and getting it ready for use.

User's Guide (Electronic documentation):

Read this guide when starting to use the machine.

After following instructions in the *Easy Setup Instructions*, read this guide for instructions on printing from your computer, direct photo printing from selected digital cameras,  faxing, copying, and scanning. This guide is included as an HTML file on the Setup CD-ROM. To read this manual, click the icon appeared on your computer after installing the drivers.

This guide contains the following information:

- Document Handling
- Paper Handling
- Copying
- Photo Printing
- Printing From Your Computer
- Preparing Your Machine For Fax
- Sending Faxes
- Receiving Faxes
- Becoming Familiar With The Software
- Troubleshooting

Software Guide (Electronic documentation):

This guide is available on the Setup CD-ROM.

Refer to this guide for full instructions on printing, scanning, and  faxing (For Windows only) from your computer. This guide, also included as an HTML file on the Setup CD-ROM, describes each function in detail, as well as the methods of using the MP Drivers, MP Navigator and the Fax driver. To read this manual, see the *User's Guide*.

This guide contains the following information:

- Printing
- Faxing
- MP Navigator
- Scanning
- Advanced scanning

Photo Application Guide (Electronic documentation):

This guide is available on the Setup CD-ROM.

This guide describes the utility software on the Setup CD-ROM, such as Easy-PhotoPrint and Easy-WebPrint, including instructions on how to scan data, various printing methods, and function details. Like the *User's Guide*, this guide is included on the Setup CD-ROM. To read this manual, see the *User's Guide*.

The  icon indicates items that are only applicable to MP780.

► How To Read The HTML Manuals

Various Web browsers are available for seeing HTML view and therefore the same text or image may appear different depending on the browser you use. The HTML manuals have been prepared on the assumption that it would be displayed and read under the following conditions:

For Windows:

- Web browser: Microsoft® Internet Explorer 5.0 or later
- Web browser screen: Full screen
- Resolution of display (Desktop): 800 × 600 pixels or above
- Color amount of display: 16 bit or more

For Macintosh:

- Web browser: Microsoft® Internet Explorer 5.0 or later, Safari 1.0 or later
- Web browser screen: Full screen
- Resolution of display (Desktop): 800 × 600 pixels or above
- Color amount of display: 32,000 or more
- We recommend you use Safari as your browser to view the HTML manuals on Macintosh. If you don't have Safari, download it on Apple Computer Inc.'s homepage and install it.

► Reading The Document

Symbols Used In This Guide

 **WARNING**

Indicates a warning concerning operations that may lead to death or injury to persons if not performed correctly. In order to use the machine safely, always pay attention to these warnings.

 **CAUTION**

Indicates a caution concerning operations that may lead to injury to persons or damage to property if not performed correctly. In order to use the machine safely, always pay attention to these cautions.



Indicates notes for operation or additional explanations. Reading these is highly recommended.

(See page nn)

Indicates a page number where additional information can be found.



Indicates items that are only applicable to MP780.

● (Operation branch title) Used for an operation that can be performed in branch procedures.

1. (Operation branch-step) Used to explain each operation of a branch procedure.

Buttons Used In This Guide

[button name]

Text enclosed in these brackets indicates a button on the Operation Panel of the machine or an item on the computer to be manipulated.
Example: [Color]

<message>

Text enclosed in these brackets indicates a message or selectable menu item which appears on the LCD (Liquid Crystal Display).
Example: <PHOTO PAPER PRO>, <OFF>

Terms Used In This Guide

machine	General term used to represent MP780/750.
default	A setting that remains in effect unless you change it.
document	The original sheets of paper, pages of a book, or photographs you copy,  fax, or scan with the machine.
paper	Paper on which you can print with the machine.
menu	A list of settings from which you select an item to set up or change. A menu has a title which appears on the LCD.

► Selecting The Language For The LCD

- 1 Press [Menu] repeatedly until <4 .SYSTEM SETTINGS> appears.**
- 2 Use [◀] or [▶] to select <DISPLAY LANGUAGE>, then press [OK].**
- 3 Use [◀] or [▶] to select the language, then press [OK].**

► Safety Information

Please read the safety warnings and cautions provided in this guide to ensure that you use your machine safely. Do not attempt to use the machine in any way not described in this guide. For detailed safety information, see *User's Guide*.

⚠ WARNING

You may cause an electric shock/fire or damage the machine if you ignore any of these safety precautions.

● Location

- Do not place the machine close to flammable solvents such as alcohol or thinners.

● Power supply

- Never attempt to plug or unplug the machine from the power supply when your hands are wet.
 - Always push the plug all the way into the power outlet.
 - Never damage, modify, stretch or excessively bend or twist the power cord. Do not place heavy objects on the power cord.
 - Never plug the machine into a power socket that is shared with other equipment (extension lead/cord, 2- or 3-way adapter, etc.).
 - Never use the machine if the power cord is bundled or knotted.
 - If you detect smoke, unusual smells or strange noises around the machine, immediately unplug the machine at the power supply and contact the Canon Customer Care Center at 800-828-4040.
- Using the machine in such conditions may result in fire or electrical shock.
- Periodically, unplug the machine and use a dry cloth to wipe off any dust or dirt collected on the plug and the power outlet.

If the machine is placed at a location exposed to a lot of dust, smoke, or high humidity, the dust collected on the plug absorbs moisture and may cause insulation failure and fire.

● Maintenance

- Use a damp cloth to clean the machine. Never use flammable solvents such as alcohol, benzene or thinners. If flammable solvents come in contact with electrical components inside the machine, it could cause a fire or electrical shock.
- Always turn OFF the power and unplug the machine from the power outlet before cleaning the machine. If you accidentally switch the machine ON while cleaning it, it may result in injury or damage the machine.

● Handling

- Do not attempt to disassemble or modify the machine. There are no user serviceable parts inside the machine.

The machine contains high-voltage components. Never attempt any maintenance procedure not described in this guide. Incorrect maintenance procedures may damage the machine, or cause a fire or electrical shock.

- Do not use flammable sprays near the machine.

This could cause a fire or electrical shock if the spray comes into contact with electrical components inside the machine.

● Others

- This product emits low level magnetic flux. If you use a cardiac pacemaker and feel abnormalities, please move away from this product and consult your doctor.
- When setting the machine near electric products with fluorescent lighting, separate the machine at least 5 7/8 inches (150 mm) from electric products equipped with fluorescent lighting. If you place it near to them, the machine may malfunction as a result of the noise emitted by the fluorescent lighting.
- When turning OFF the power, be sure to press [ON/OFF] and confirm that the Alarm Lamp has shut off. If you pull the power plug out of the wall outlet while the Alarm Lamp is lit or flashing, the print head is not protected, and you may not be able to print later.

CAUTION

You may cause injury or damage the machine if you ignore any of these safety precautions.

● Location

- Place the machine on a flat, stable, vibration-free surface that is strong enough to support its weight.
- Do not install the machine in a location that is very humid or dusty, in direct sunlight, outdoors, or close to a heating source. Installing in such a location may result in fire or electrical shock. To avoid the risk of fire or electrical shocks, install the machine in a location with an ambient temperature range of 41°F to 95°F (5°C to 35°C) and humidity of 10% to 90% (condensation free).
- Do not place the machine on a thick rug or carpet. If fibers or dust come inside the machine, it could cause a fire.

● **Power supply**

- Never remove the plug by pulling on the cord.
Pulling on the power cord may damage the cord and cause a fire or electrical shock.
- Do not use an extension cord as this may result in fire or electrical shock.
- Ensure that the area around the power outlet is kept clear at all times so you can easily unplug the power cord if necessary. Otherwise you will be unable to disconnect the power plug in case of an emergency.
- Never use a power supply source other than the one rated for the machine in the country where you purchased the machine as it may result in fire or electrical shock.
The operating requirement of this machine is as follows:
110-120V AC, 50/60 Hz or 220-240V AC, 50/60 Hz (depending on local electrical requirements)

● **Handling**

- Close the Document Cover gently to avoid catching your hand. Failing to do so may result in personal injury.
- Do not press down hard on the Document Cover when using the Platen Glass to scan thick books. This may damage the Platen Glass and Document Cover, and/or result in personal injury.
- When moving the machine, carry the machine at both ends.
- Do not insert your hands into the machine while it is printing. Parts inside the machine are moving and this may result in injury.
- Do not turn the machine upside down. Ink may leak out and stain clothing or the surrounding area.

● **Print head/Ink tanks**

- For safety reasons, store print heads and ink tanks out of the reach of small children. If a child ingests any ink, consult a doctor immediately.
- Do not shake print heads or ink tanks. Ink may leak out and stain clothing or the surrounding area.
- Never touch the print head.

► Legal Limitations On Use Of Your Product And Use Of Images

It may be unlawful to make copies of, scan, print or use reproductions of the following documents. The list provided is non-exhaustive. When in doubt, check with a legal representative in your jurisdiction.

- Paper money
- Money orders
- Certificates of deposit
- Postage stamps (canceled or uncanceled)
- Identifying badges or insignias
- Selective service or draft papers
- Checks or drafts issued by governmental agencies
- Motor vehicle licenses and certificates of title
- Traveler's checks
- Food stamps
- Passports
- Immigration papers
- Internal revenue stamps (canceled or uncanceled)
- Bonds or other certificates of indebtedness
- Stock certificates
- Copyrighted works/works of art without permission of copyright owner

► Users In The U.S.A.

Pre-Installation Requirements For MP780

A. Location

Supply a suitable table, cabinet, or desk for the machine. See the Appendix for the machine's specific dimensions and weight.

B. Order Information

1. Only a single telephone line (touch-tone or rotary) should be used.
2. Order an RJ11-C modular wall jack (USOC code), which should be installed by the telephone company. If the RJ11-C modular wall jack is not present, telephone/fax operation is not possible.

3. Order a normal business line from your telephone company's business representative. The line should be a regular voice grade line or the equivalent one. Use one line per machine.

DDD (Direct Distance Dial) line

-or-

IDDD (International Direct Distance Dial) line if you communicate overseas

Canon recommends an individual line following industry standards, such as the 2500 (touch-tone) or 500 (rotary/pulse dial) telephones. A dedicated extension off a PBX (Private Branch Exchange) unit without "Call Waiting" can be used with the machine. Button telephone systems are not recommended because they send nonstandard signals to individual telephones for ringing and special codes, which may cause a fax error.

C. Power Requirements

This machine should be connected to a standard 120 volt AC, two-prong grounded outlet only. Do not connect this machine to an outlet or power line shared with other appliances that cause "electrical noise." Air conditioners, electric typewriters, copiers, and machines of this sort generate electrical noise which often interferes with communications equipment and the sending or receiving of documents.

Connection Of The Equipment

This equipment complies with Part 68 of the FCC rules and the requirements adopted by the ACTA. On the rear panel of this equipment is a label that contains, among other information, a product identifier in the format US:AAAEQ##TXXXX. If requested, this number must be provided to the telephone company.

The REN is used to determine the number of devices that may be connected to a telephone line. Excessive RENs on a telephone line may result in the devices not ringing in response to an incoming call. In most but not all areas, the sum of RENs should not exceed five (5.0). To be certain of the number of devices that may be connected to a line, as determined by the total RENs, contact the local telephone company. The REN for this product is part of the product identifier that has the format US:AAAEQ##TXXXX. The digits represented by ## are the REN without a decimal point (e.g., 03 is a REN of 0.3). An FCC compliant telephone line cable cord and modular plug is provided with this equipment. This equipment is designed to be connected to the telephone network or premises wiring using a compatible modular jack which is Part 68 compliant. See Installation instructions for details. This equipment if it uses a telephone receiver is hearing aid compatible.

This equipment may not be used on coin service provided by the telephone company. Connection to party lines is subjected to state tariffs.

In Case Of Equipment Malfunction

Should any malfunction occur which cannot be corrected by the procedures described in this guide, disconnect the equipment from the telephone line cable, turn off the power and disconnect the power cord. The telephone line cable should not be reconnected or the main power switch turned ON until the problem is completely resolved. Users should contact their local authorized Canon Facsimile Service Dealer for the servicing of equipment.

Rights Of The Telephone Company

If this equipment causes harm to the telephone network, the telephone company may temporarily disconnect service. The telephone company also retains the right to make changes in facilities and services that may affect the operation of this equipment. When such changes are necessary, the telephone company is required to give adequate prior notice to the user. However, if advance notice is not possible, the telephone company will notify the customer as soon as possible. Also, the customer will be advised of his/her right to file a complaint with the FCC if he/she believes it is necessary.

WARNING

- **The Telephone Consumer Protection Act of 1991 makes it unlawful for any person to use a computer or other electronic device to send any message via a telephone facsimile machine unless such message clearly contains in a margin at the top or bottom of each transmitted page, or on the first page of the transmission, the date and time it is sent and an identification of the business or other entity, or other individual sending the message and the telephone number of the sending machine or such business, other entity, or individual.**

In order to program this information into your machine, you should complete the procedure to register your name, unit's telephone number, time, and date. (See "Registering Sender Information," on page 35.)

FCC Notice

PIXMA MP780: Facsimile Transceiver, Model H12458

PIXMA MP750: H12456

This device complies with Part 15 of the FCC Rules. Operation is subject to the following two conditions:

- (1) This device may not cause harmful interference, and
- (2) this device must accept any interference received, including interference that may cause undesired operation.

This equipment has been tested and found to comply with the limits for a class B digital device, pursuant to Part 15 of the FCC Rules. These limits are designed to provide reasonable protection against harmful interference in a residential installation. This equipment generates, uses and can radiate radio frequency energy and, if not installed and used in accordance with the instructions, may cause harmful interference to radio communications. However, there is no guarantee that interference will not occur in a particular installation. If this equipment does cause harmful interference to radio or television reception, which can be determined by turning the equipment off and on, the user is encouraged to try to correct the interference by one or more of the following measures:

- Reorient or relocate the receiving antenna.
- Increase the separation between the equipment and receiver.
- Connect the equipment into an outlet on a circuit different from that to which the receiver is connected.
- Consult the dealer or an experienced radio/TV technician for help.

Use of shielded cable is required to comply with class B limits in Subpart B of Part 15 of the FCC Rules.

▲ WARNING

- **Do not make any changes or modifications to the equipment unless otherwise specified in this guide. If such changes or modifications should be made, you could be required to stop operation of the equipment.**

Mercury Legislation

(Hg) LAMP(S) INSIDE THIS PRODUCT CONTAIN MERCURY AND MUST BE RECYCLED OR DISPOSED OF ACCORDING TO LOCAL, STATE OR FEDERAL LAWS

Canon U.S.A. Inc.

One Canon Plaza, Lake Success, NY 11042, U.S.A.

TEL No. (516) 328-5600

Canon U.S.A., INC. LIMITED WARRANTY

The limited warranty set forth below is given by Canon U.S.A., Inc. (“Canon USA”) with respect to the new or refurbished Canon-brand product (“Product”) packaged with this limited warranty, when purchased and used in the United States only.

The Product is warranted against defects in materials and workmanship under normal use and service (a) for a period of one (1) year from the date of original purchase when delivered to you in new condition in its original container or (b) for 90 days from the date of original purchase for refurbished Products. Defective parts or a defective Product returned to a Canon USA repair facility or a Canon USA Authorized Service Facility (“ASF”), and proven to be defective upon inspection, will be repaired, exchanged for new or comparable rebuilt parts, or exchanged for a refurbished Product, as determined by the Canon USA repair facility or the ASF. Warranty repair or replacement shall not extend the original warranty period of the Product. A dated proof of purchase is required at the time of warranty service. A copy of your dated bill of sale will satisfy this requirement. This warranty does not cover any accessories, or any consumables, such as paper or ink cartridges, as to which there shall be no warranty or replacement.

This limited warranty shall only apply if the Product is used in conjunction with compatible computers, peripheral equipment and software. Canon USA shall have no responsibility for such items except for compatible Canon brand peripheral equipment covered by a separate warranty (“Separate Warranty”). Repairs of such Canon brand peripheral equipment shall be governed by the terms of the Separate Warranty. Non-Canon brand equipment and software that may be distributed with the Product are sold “as is” and without warranty of any kind by Canon USA, including any implied warranty regarding merchantability or fitness for a particular purpose, and all such warranties are disclaimed. The sole warranty, if any, with respect to such non-Canon brand items is given by the manufacturer or producer thereof.

This limited warranty covers all defects encountered in normal use of the Product and does not apply in the following cases:

- (a) Loss of or damage to the Product due to abuse, neglect, mishandling, improper packaging by you, alteration, accident, electrical current fluctuations, improper use, failure to follow operating or maintenance instructions in, or environmental conditions prescribed in, Canon USA’s user’s manual or other documentation, or services performed by someone other than a Canon USA repair facility or ASF. Without limiting the foregoing, dropping the Product, scratches, and abrasions will be presumed to have resulted from misuse, abuse or failure to operate the Product as set forth in the user’s manual or other documentation for the Product.
- (b) Use of parts or supplies (other than those sold by Canon USA) that cause damage to the Product or cause abnormally frequent service calls or service problems.
- (c) If the Product has had its serial number or dating defaced, altered or removed.

ANY SYSTEM SOFTWARE (WHETHER FACTORY LOADED ON THE PRODUCT OR CONTAINED ON THE SOFTWARE DISKETTES OR CD-ROMS ENCLOSED WITH, OR ACCOMPANYING, THE PRODUCT), AND ANY UTILITY SOFTWARE, DISTRIBUTED WITH OR FOR THE PRODUCT, IS SOLD "AS IS" AND WITHOUT WARRANTY BY CANON USA. THE SOLE WARRANTY WITH RESPECT TO SUCH SOFTWARE IS CONTAINED IN THE SOFTWARE MANUFACTURER'S LICENSE AGREEMENT DISTRIBUTED THEREWITH, INCLUDING ANY LIMITATIONS AND DISCLAIMERS THEREON. PLEASE CONTACT CANON USA IMMEDIATELY IF YOU HAVE NOT RECEIVED A COPY OF THE SOFTWARE MANUFACTURER'S LICENSE AGREEMENT.

NO IMPLIED WARRANTY, INCLUDING ANY IMPLIED WARRANTY OF MERCHANTABILITY OR FITNESS FOR A PARTICULAR PURPOSE, APPLIES TO THE PRODUCT AFTER THE APPLICABLE PERIOD OF THE EXPRESS LIMITED WARRANTY STATED ABOVE, AND NO OTHER EXPRESS WARRANTY OR GUARANTY, EXCEPT AS MENTIONED ABOVE, GIVEN BY ANY PERSON OR ENTITY WITH RESPECT TO THE PRODUCT SHALL BIND CANON USA, OR ITS ASF. (SOME STATES DO NOT ALLOW LIMITATIONS ON HOW LONG AN IMPLIED WARRANTY LASTS, SO THE ABOVE LIMITATION MAY NOT APPLY TO YOU.) CANON USA SHALL NOT BE LIABLE FOR LOSS OF REVENUES OR PROFITS, INCONVENIENCE, EXPENSE FOR SUBSTITUTE EQUIPMENT OR SERVICE, STORAGE CHARGES, LOSS OR CORRUPTION OF DATA, OR ANY OTHER SPECIAL, INCIDENTAL OR CONSEQUENTIAL DAMAGES CAUSED BY THE USE, MISUSE, OR INABILITY TO USE THE PRODUCT REGARDLESS OF THE LEGAL THEORY ON WHICH THE CLAIM IS BASED, AND EVEN IF CANON USA OR ITS ASF HAS BEEN ADVISED OF THE POSSIBILITY OF SUCH DAMAGES. NOR SHALL RECOVERY OF ANY KIND AGAINST CANON USA OR ITS ASF BE GREATER IN AMOUNT THAN THE PURCHASE PRICE OF THE PRODUCT CAUSING THE ALLEGED DAMAGE. WITHOUT LIMITING THE FOREGOING, YOU ASSUME ALL RISK AND LIABILITY FOR LOSS, DAMAGE OR INJURY TO YOU AND YOUR PROPERTY AND TO OTHERS AND THEIR PROPERTY ARISING OUT OF THE POSSESSION, USE, MISUSE, OR INABILITY TO USE THE PRODUCT SOLD BY CANON USA NOT CAUSED SOLELY AND DIRECTLY BY THE NEGLIGENCE OF CANON USA, OR ITS ASF. (SOME STATES DO NOT ALLOW THE EXCLUSION OR LIMITATION OF INCIDENTAL OR CONSEQUENTIAL DAMAGES, SO THE ABOVE EXCLUSION OR LIMITATION MAY NOT APPLY TO YOU.) THIS LIMITED WARRANTY SHALL NOT EXTEND TO ANYONE OTHER THAN THE ORIGINAL PURCHASER OF THE PRODUCT OR THE PERSON FOR WHOM IT WAS PURCHASED AS A GIFT, AND STATES YOUR EXCLUSIVE REMEDY.

Canon USA offers a range of customer technical support* options:

- Interactive troubleshooting, e-mail technical support, the latest driver downloads and answers to frequently asked questions (www.canontechsupport.com)
- Toll-free live technical support Monday-Saturday (excluding holidays) at 1-800-828-4040
- Telephone Device for the Deaf (TDD-1-866-251-3752)
- Repair or Exchange Service Options:
In the event service is required for the Product during the limited warranty period, Canon USA offers two hardware support options:

Authorized Service Facility Carry-In / Mail-In Service

Canon USA's Carry-In/Mail-In Service provides repair or exchange, at Canon USA's option, through Canon USA's Authorized Service Facility (ASF) network. The name and telephone number of the ASF(s) near you may be obtained from Canon USA's Web site at: www.canontechsupport.com or by calling the Canon USA Customer Care Center at 1-800-828-4040, or any time while speaking to a technical support person. A Product covered by this limited warranty will be repaired or exchanged, as determined by Canon USA, and returned without charge by the ASF.

InstantExchange Service **

Under Canon USA's InstantExchange Service you may exchange an eligible defective Product during the limited warranty period for a new or refurbished Product, at Canon USA's option. This Service is available in the continental United States, Alaska and Hawaii and is utilized by calling Canon USA's Customer Care Center at 1-800-828-4040 8 a.m. to midnight Monday through Friday and 10 a.m. to 8 p.m. Saturday (except holidays). The foregoing times are subject to change in Canon USA's sole discretion. If your call is completed by 3pm Eastern Time, Canon USA's repair facility will, at its expense, ship out the replacement product the same day, via overnight courier, for delivery the following business day (second business day in Alaska and Hawaii).

A further explanation of the service/support options is available at the time of your call to the live technical support number(s) above or via the website at www.canontechsupport.com. Please note that under the InstantExchange program, a replacement product will be provided to you prior to your return of the defective product. Since the defective product becomes the property of Canon USA at the time of the exchange, the defective product must be returned in the shipping materials provided. If the defective product is not returned, as directed, you will be responsible for the value of the replacement product, for which Canon USA may invoice you.

This limited warranty gives you specific legal rights, and you may also have other rights, which vary from state to state.

* Support program specifics are subject to change without notice.

** InstantExchange warranty service is subject to the availability of refurbished or new replacement units.

Canon U.S.A., Inc.
One Canon Plaza
Lake Success, NY 11042
USA

Canon is a registered trademark of Canon Inc.

► Users In Canada

Pre-installation Requirements For Canon Facsimile Equipment

A. Location

Supply a suitable table, cabinet, or desk for the machine. See the Appendix for the machine's specific dimensions and weight.

B. Order Information

1. Provide only a single line touch-tone or rotary telephone set terminated with a standard 4-pin modular telephone plug. (Touch-tone is recommended if available in your area.)
2. Order a CA11A modular wall jack, which should be installed by the telephone company. If the CA11A modular wall jack is not present, installation cannot occur.
3. Order a normal business line from your telephone company's business representative. The line should be a regular voice grade line or an equivalent one. Use one line per machine.

DDD (Direct Distance Dial) line

-or-

IDDD (International Direct Distance Dial) line if you communicate overseas

NOTE

- Canon recommends an individual line following industry standards, such as the 2500 (touch-tone) or 500 (rotary/pulse dial) telephones. A dedicated extension off a PBX (Private Branch Exchange) unit without "Call Waiting" can be used with your facsimile unit. Button telephone systems are not recommended because they send non-standard signals to individual telephones for ringing and special codes, which may cause a fax error.

C. Power Requirements

The power outlet should be a two-prong grounded receptacle (Single or Duplex). It should be independent from copiers, heaters, air conditioners or any electric equipment that is thermostatically controlled. The rated value is 120 volts and 15 amperes. The CA11A modular jack should be relatively close to the power outlet to facilitate installation.

Notice

This equipment meets the applicable Industry Canada terminal Specifications.

Avis

Le présent matériel est conforme aux spécifications techniques applicables d'Industrie Canada.

Before installing this equipment, users should ensure that it is permitted to be connected to the facilities of the local telecommunications company. The equipment must also be installed using an acceptable method of connection. In some cases, the company's inside wiring associated with a single-line individual service may be extended by means of a certified connector assembly (telephone extension cord). The customer should be aware that compliance with the above conditions may not prevent degradation of service in some situations.

The Ringer Equivalence Number is an indication of the maximum number of devices allowed to be connected to a telephone interface. The termination on an interface may consist of any combination of devices subject only to the requirement that the sum of the RENs of all the devices does not exceed five.

Even if the dual-line option is installed, the REN is applicable to each port.

Avis

L'indice d'équivalence de la sonnerie (IES) sert à indiquer le nombre maximal de terminaux qui peuvent être raccordés à une interface téléphonique. La terminaison d'une interface peut consister en une combinaison quelconque de dispositifs, à la seule condition que la somme d'indices d'équivalence de la sonnerie de tous les dispositifs n'exécède pas 5.

Repairs to certified equipment should be made by an authorized Canadian maintenance facility designated by the supplier. Any repairs or alterations made by the user to this equipment, or equipment malfunctions, may give the telecommunications company cause to request the user to disconnect the equipment.

Users should ensure for their own protection that the electrical ground connections of the power utility, telephone lines and internal metallic water pipe system, if present, are connected together. This precaution may be particularly important in rural areas.

⚠ CAUTION

- **Users should not attempt to make such connections themselves, but should contact the appropriate electric inspection authority, or electrician, as appropriate.**
- **This Class B digital apparatus meets all requirements of the Canadian Interference-Causing Equipment Regulations.**
- **Cet appareil numérique de la classe B respecte toutes les exigences du Règlement sur le matériel brouilleur du Canada.**

1 Introduction

► Main Components And Their Functions

MP780 is shown here.



- The Operation Panels for MP780 and MP750 are different.

Machine

● Front

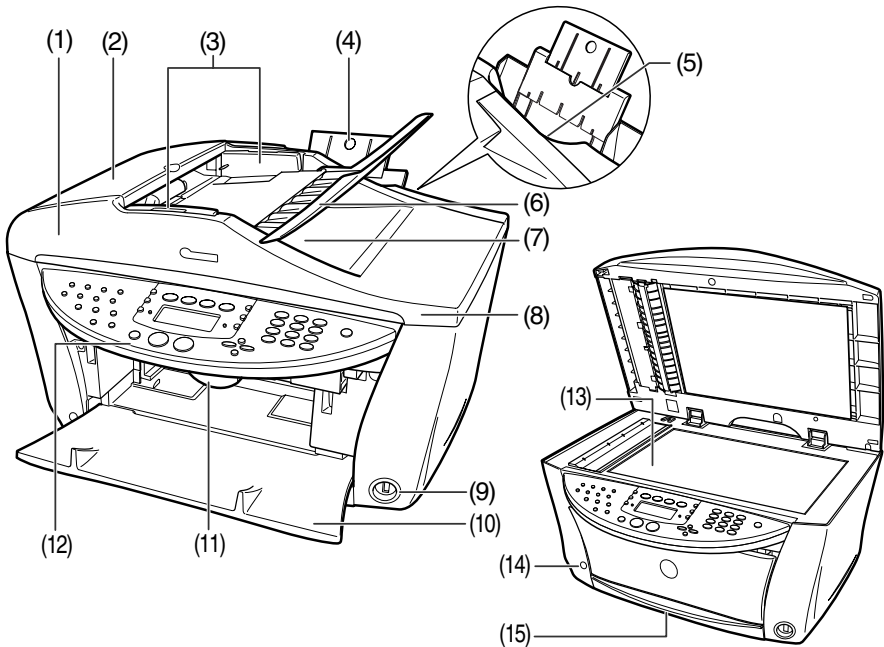

(1) ADF (Automatic Document Feeder)

Automatically scans in documents loaded in the Document Tray.

(2) Feeder Cover

Open when clearing jammed documents.

(3) Document Guides

Adjust these guides to match the document width.

(4) Paper Support

Supports paper loaded on the tray. Extend it before loading paper by putting your finger in the rounded indent and pulling out the extension until it stops.

(5) Auto Sheet Feeder

Load paper here with the side to print onto facing up. Automatically feeds one sheet at a time from the Paper Support.

(6) Document Tray

Open to load a document. Once loaded, the document is fed one page at a time. Load the document with the side you want to scan facing up.

(7) Document Output Slot

Documents scanned from the Document Tray are delivered here.

(8) Document Cover

Covers the Platen Glass. Open this cover when loading a document on the Platen Glass.

(9) Direct Print Port (for digital camera)

Used to connect a PictBridge- or Canon Bubble Jet Direct-compatible digital camera or digital video camcorder to the machine when printing images directly from the camera. For details, see page 33.

(10) Paper Output Tray

Printouts are output to this tray. Open the tray before you start copying or printing, by pressing the Open Button. If closed, the tray will automatically open when the machine starts to copy or print. When not being used, keep it closed in the machine.

(11) Scanning Unit Lever

Pull forward to open the Scanning Unit.

(12) Operation Panel

Displays the operating status of the machine. It is also used to change or check the settings of each function. For details, see page 22.

(13) Platen Glass

Used to load a document to be processed.

(14) Open Button

Press this button to open the Paper Output Tray accommodated in the machine.

(15) Cassette

Load paper here with the side to print onto facing down.

● Rear view and interior

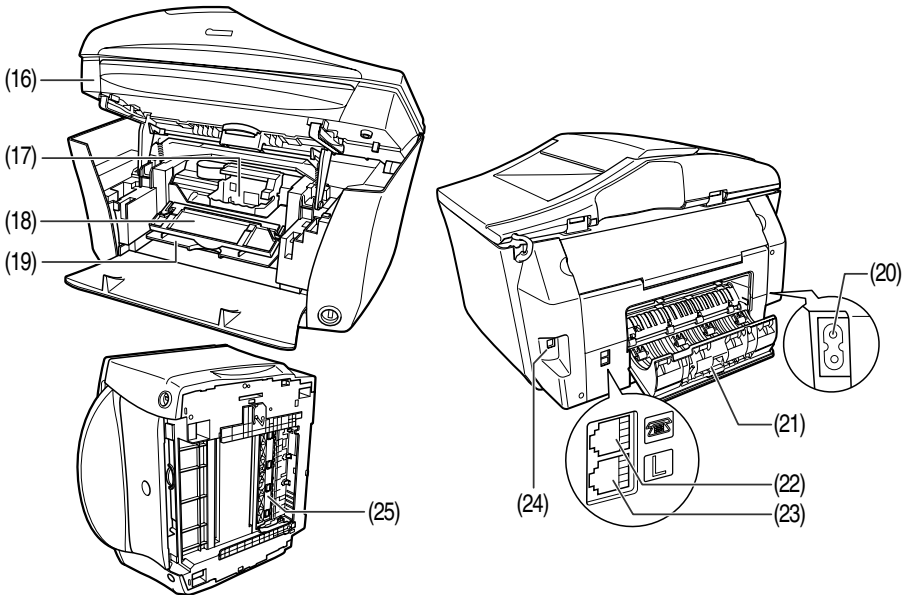

(16) Scanning Unit (Printer Cover)

Lift this unit until it locks into place when the Inner Cover 2 needs to be opened.

(17) Print Head Holder

Used to install a print head.

(18) Inner Cover 2

Open this cover when replacing the ink tanks, or clearing a paper jam.

(19) Inner Cover 1

Open this cover when replacing the ink tanks, or clearing a paper jam.

(20) Power Connector

Used to connect the power cord to the machine.

(21) Rear Cover

Open when clearing jammed paper.

(22) External Device Jack

Connects the external device.

(23) Telephone Line Jack

Connects the telephone line.

(24) USB Connector (for computer)

Used to connect the machine to a computer for scanning, printing, and other operations.

(25) Duplexing Transport Unit

Open to clear paper jams.

Operation Panel

MP780 is shown here.

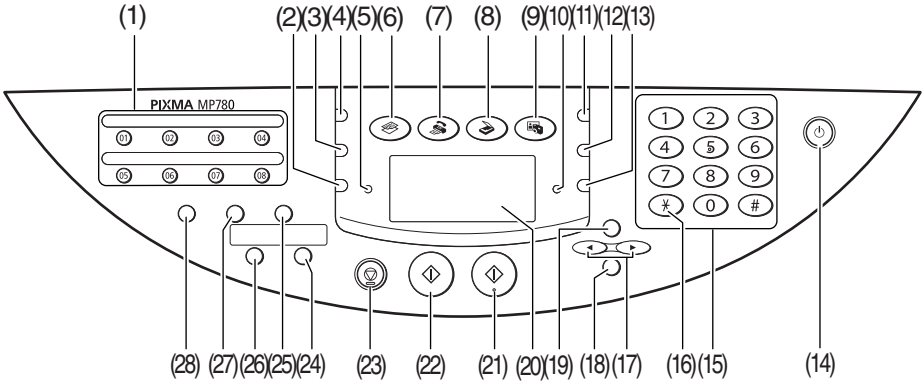

(1)  One-Touch Speed Dial Key

Push these buttons to dial pre-registered fax or telephone numbers.

(2) [Feed Switch]

Selects the paper source.

(3) [Image Quality]

Selects the copy resolution and  fax resolution.

(4) [Exposure]

Selects the copy exposure and  fax exposure.

(5) In Use/Memory Lamp

Flashes or lights during operation. Lights also when there are documents stored in the machine's memory.

(6) [COPY]

Switches the machine to copy mode.

(7)  [FAX]

Switches the machine to fax mode.

(8) [SCAN]

Switches the machine to scan mode. In scan mode, the machine scans a document to your computer according to the settings selected. This button is used when the machine is connected to a computer.

(9) [PHOTO]

Switches the machine to photo print mode.

(10) Alarm Lamp

Flashes when the machine is turned ON or OFF, when an error occurs, or when paper or ink has run out.

(11) [Enlarge/Reduce]

Sets the enlargement or reduction ratio for copying.

(12) [Collate]

Selects software collation (sorting).

(13) [Paper]

Selects the paper size and paper type for copying, and  for received faxes.

(14) [ON/OFF]

Turns the machine ON and OFF. Before turning ON the machine, make sure the Scanning Unit is closed.

(15) Numeric Keys

Enter numerical values such as the number of copies, as well as  fax/telephone numbers and characters.

(16)  [Tone]

Switches temporarily to tone dialing. Also changes the mode when entering characters.

(17) [◀(-)] and [▶(+)]

Scroll through menu selections, and increase or decrease the number of copies or the image file number.

(18) [OK]

Selects items in menus, and confirms selections. Restores the machine to normal operation if there is an error while printing or if paper jams. Ejects documents remaining in the ADF.

(19) [Menu]

Accesses the settings to customize operation of your machine.

(20) LCD (Liquid Crystal Display)

Displays messages, menu selections, and the operation status.

(21) [Color]

Starts color copying, or  faxing.

(22) [Black]

Starts black & white copying, or  faxing.

(23) [Stop/Reset]

Cancels operations and returns the machine to standby mode.

(24) [Two-Sided]

Selects two-sided copying.

(25)  [Hook]

Engages or disengages the telephone line.

(26) [2 on 1]

Selects 2 on 1 copying.

(27)  [Coded Dial]

Press this button and a two-digit code to dial a pre-registered fax or telephone number.

(28)  [Redial/Pause]

Redials the last dialed number. Also enters pauses between or after numbers when dialing or registering numbers.

LCD (Liquid Crystal Display)

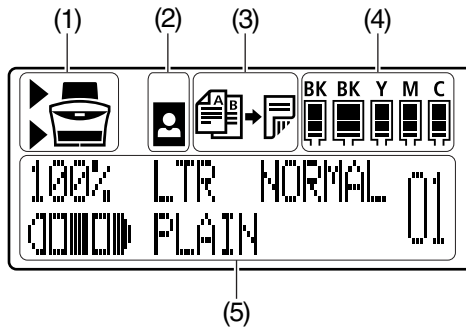

(1) Feed Switch

“▶” is displayed by the currently selected paper source. This is displayed above when the Auto Sheet Feeder is selected, or below when the Cassette is selected.

(2) Borderless/with border

Indicates whether a border should be applied.  means without a border (“borderless”).

(3) Two-sided copying

Displayed when two-sided copying is selected.

(4) Remaining ink

Indicates how much ink is left. Displays from the left in the following sequence: 6BK/3eBK/6Y/6M/6C. (See page 44 for ink tank installation instruction.)

(5) Messages

Displays messages, menu items, and the status of operations.

* Messages displayed on the LCD may differ, depending on the specification of your machine.

2 Document Handling

► Document Requirements

	Platen Glass	ADF
Document type	<ul style="list-style-type: none"> • Special types of paper • Photographs • Book • Documents that are not suitable for the ADF 	Multipage documents of the same size, thickness, and weight
Size (W × L)	Max. 8 1/2 × 11 3/4 in. (216 × 297 mm)	Max. 8 1/2 × 39 in. (216 mm × 1 m) Min. 4 1/8 × 5 7/8 in. (105 × 148 mm)
Quantity	• 1 sheet	<ul style="list-style-type: none"> • Max. 35 pages of A4- or letter-size sheets (20 lb. or 75 g/m² paper) • Max. 30 pages of legal-size sheets (20 lb. or 75 g/m² paper) • 1 sheet for sizes other than these
Thickness	Max. 3/4 in. (20 mm)	0.002 to 0.005 in. (0.06 to 0.13 mm)
Weight	—	13 to 24 lb. (50 to 90 g/m ²)

► Loading Documents

Using The Platen Glass

- 1 Lift the Document Cover.**
- 2 Load your document on the Platen Glass.**

Align the upper left corner of your document with the alignment mark on the upper left corner of the Platen Glass.

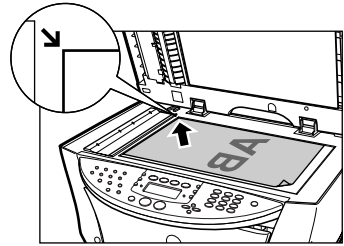

- 3 Gently close the Document Cover.**

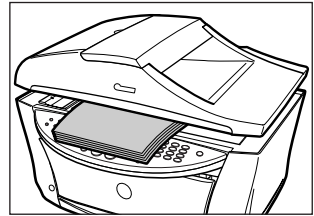

Using The ADF

- 1 Remove any documents from the Platen Glass.
- 2 Open the Document Tray.

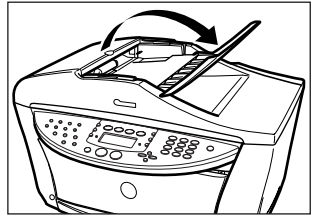

- 3 Load the document in the ADF (1).
- 4 Adjust the Document Guides to match the document width (2).

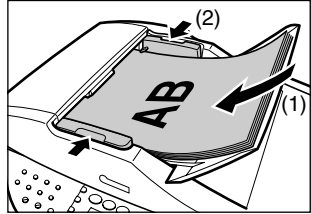

3 Paper Handling

► Recommended Paper And Requirements

Media Type	Load Limit	
	Auto Sheet Feeder	Cassette
Plain paper	Approx. 150 sheets (17 lbs or 64 g/m ²)	Approx. 150 sheets (17 lbs or 64 g/m ²)
Envelopes	Approx. 10 envelopes	5 envelopes
Super White Paper	Less than 1/2 in. (13 mm) thick	Less than 1/2 in. (13 mm) thick
High Resolution Paper	Approx. 80 sheets	Approx. 80 sheets
Glossy Photo Paper	10 sheets (A4/Letter), 20 sheets (4" × 6")	10 sheets (A4/Letter), 20 sheets (4" × 6")
Matte Photo Paper	10 sheets	10 sheets
Photo Paper Plus Glossy	10 sheets (A4/Letter/5" × 7"), 20 sheets (4" × 6")	10 sheets (A4/Letter/5" × 7"), 20 sheets (4" × 6")
Photo Paper Plus Double Sided	10 sheets (A4/Letter/5" × 7")	10 sheets (A4/Letter/5" × 7")
Photo Paper Plus Semi-Glossy	10 sheets (A4/Letter/5" × 7"), 20 sheets (4" × 6")	10 sheets (A4/Letter/5" × 7"), 20 sheets (4" × 6")
Photo Paper Pro	10 sheets (A4/Letter), 20 sheets (4" × 6")	10 sheets (A4/Letter), 20 sheets (4" × 6")
Transparencies	30 sheets	30 sheets
T-Shirt Transfers	1 sheet	1 sheet

► Auto Sheet Feeder And Cassette

Paper can be loaded into the machine at two locations: the Auto Sheet Feeder at the rear, and the Cassette at the front. To switch the paper source, press [Feed Switch]. The selected feeder is indicated on the LCD.

Loading Paper In The Auto Sheet Feeder

- 1 Open the Auto Sheet Feeder (1), then pull out the Paper Support (2).

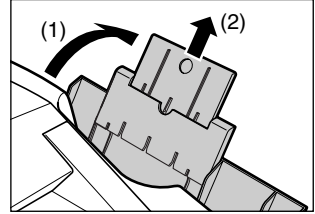

- 2 Place a stack of paper (print side up) in the Auto Sheet Feeder (1), and pinch the paper guide (A) and adjust it to the left side of the stack (2).

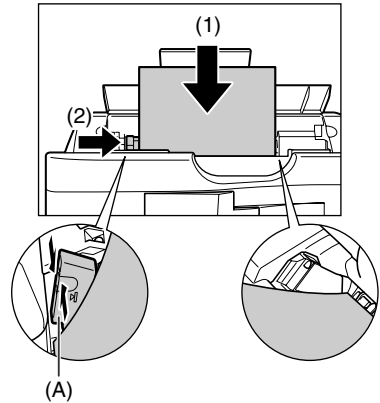

Loading Paper In The Cassette

1 Pull out the Cassette towards you.

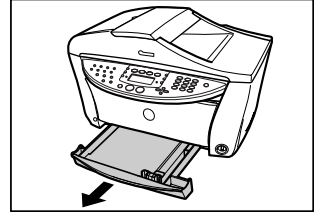

2 Load the stack of paper (print side down) (1). Grasp the paper guide (A) and align it to the left edge of the paper stack (2). Align the front edge of the paper stack in the same way (3).

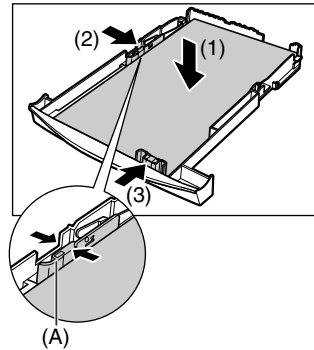

3 Load the Cassette into the machine.

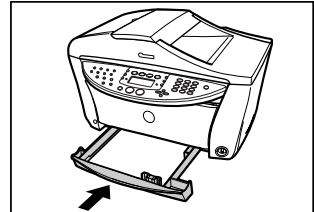

4 Copying

► Making Copies

When making color or black & white copies, you can adjust the print resolution and density. You can also change reduction or enlargement settings. For more information, see *User's Guide*.

- 1 Load the document on the Platen Glass or the ADF.**
- 2 Press [COPY].**
- 3 Select the paper source with [Feed Switch].**
- 4 Use [◀] or [▶] to select the number of copies, or enter the number using the Numeric Keys (max. 99 copies).**
- 5 Adjust the settings for your document as necessary.**
- 6 Press [Color] for color copying, or [Black] for black & white copying.**

► Advanced Copy Features

- 2 on 1 copying** Reduces two document pages to fit onto one page. Press [2 on 1].
- Two-sided copying** Reduces two document pages to a single sheet of paper. Press [Two-Sided].
- Collation** Makes multiple copies of a document delivered in sorted sets. Press [Collate].
- Borderless copying** Copies color images so that they fill the entire page without borders.*
- Repeating an image on a page** Copies an image multiple times onto a single page.*

* For more information, see *User's Guide*.

5 Photo Printing Directly From A Digital Camera

Connecting a PictBridge compatible or Canon “Bubble Jet Direct” compatible digital camera or digital video camcorder to the MP780/750 enables you to print captured images directly without using a computer.

► Connecting To A Digital Camera

- 1 Turn on the machine.**
- 2 Select the paper source with [Feed Switch].**
- 3 Load the paper in the Auto Sheet Feeder or the Cassette.**
- 4 Make sure the camera is turned off.**
- 5 Connect the camera to the machine using the USB cable (for connection to a computer) supplied with the camera.**

The digital camera turns itself on automatically when the connection is established. If your model of camera does not turn itself on automatically, turn it on manually.

- 6 You are now ready to print images from the camera.**

6 Preparing Your Machine For Fax

► Examples Of Connecting The Machine

Connecting A Computer

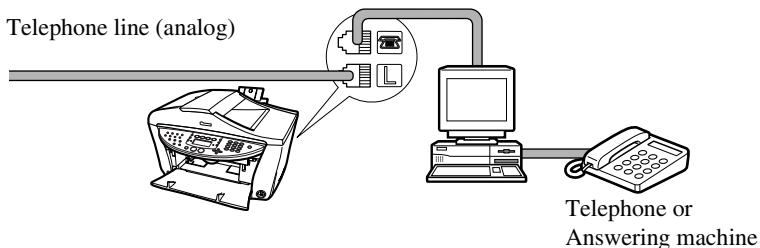

Connecting A Telephone Or Answering Machine

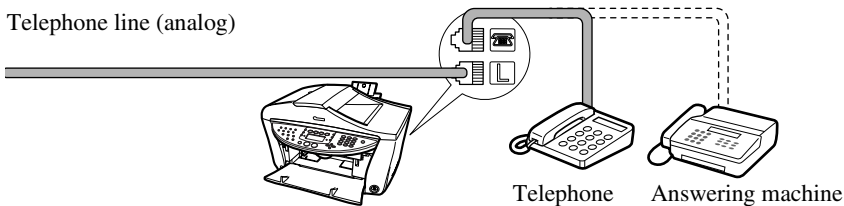

ADSL Connection

For details on ADSL connection and settings, see the manual supplied with your ADSL modem.

ISDN Connection

For details on ISDN connection and settings, see the manuals supplied with your terminal adapter or dial-up router.

► Setting The Telephone Line Type

- 1 Press [FAX], then press [Menu].
- 2 Use [◀] or [▶] to select <USER SETTINGS>, then press [OK].
- 3 Use [◀] or [▶] to select <TEL LINE TYPE>, then press [OK].
- 4 Use [◀] or [▶] to select the telephone line type.
 - <TOUCH TONE>: Suitable for tone dialing.
 - <ROTARY PULSE>: Suitable for pulse dialing.
- 5 Press [OK], then press [Stop/Reset].

► Registering Sender Information

- 1 Press [FAX], then press [Menu].
- 2 Use [◀] or [▶] to select <USER SETTINGS>, then press [OK] twice.
- 3 Use [◀] or [▶] to select <DATE/TIME SETTING>, then press [OK].
- 4 Use the Numeric Keys to enter the date and time (in 24-hour format), then press [OK].
- 5 Use [◀] or [▶] to select <UNIT TEL NUMBER>, then press [OK].
- 6 Use the Numeric Keys to enter your fax/telephone number (max. 20 digits, including spaces), then press [OK] twice.
- 7 Use [◀] or [▶] to select <UNIT NAME>, then press [OK].
- 8 Use the Numeric Keys to enter your name (max. 24 characters, including spaces), then press [OK].
- 9 Press [Stop/Reset].

► Registering One-Touch Speed Dialing Or Coded Speed Dialing



- There is also a group dialing method to send a document to all numbers in the registered group. For details, see *User's Guide*.

- 1 Press [FAX], then press [Menu].**
- 2 Use [◀] or [▶] to select <TEL# REGISTRATION>, then press [OK].**
- 3 Use [◀] or [▶] to select <1-TOUCH SPD DIAL> or <CODED SPEED DIAL> then press [OK].**
 - If you select <1-TOUCH SPD DIAL>:
 1. Use [◀] or [▶] to select a One-Touch Speed Dial Key (01 to 08) then press [OK] twice.
 - If you select <CODED SPEED DIAL>:
 1. Use [◀] or [▶] to select a coded speed dialing code (00 to 99) then press [OK] twice.
- 4 Use the Numeric Keys to enter the fax/telephone number you want to register (max. 40 digits, including spaces and pauses) then press [OK] twice.**
- 5 Use the Numeric Keys to enter a name (max. 16 characters, including spaces) then press [OK].**
- 6 Press [Stop/Reset] to return to standby mode.**

Changing Or Deleting A One-Touch Speed Dial And A Coded Speed Dial

Follow this procedure:

1. Follow the procedures from step 1 to 3 under “Registering One-Touch Speed Dialing Or Coded Speed Dialing”.

● **To change a registered number:**

2. Use [◀] to delete the registered number.
3. Use the Numeric Keys to enter the new number.
4. Press [OK], then press [Stop/Reset].

● **To change a registered name:**

2. Press [OK] twice.
3. Press and hold [◀] to delete the registered name.
4. Use the Numeric Keys to enter the new name.
5. Press [OK], then press [Stop/Reset].

● **To delete an entire entry:**

2. Press and hold [◀] to clear the registered number.
3. Press [OK], then press [Stop/Reset].

The name will automatically be deleted when you delete the number.

► Setting Daylight Saving Time (Summer Time)

- 1** Press [FAX], then press [Menu] three times.
- 2** Use [◀] or [▶] to select <SUMMER TIME>, then press [OK].
- 3** Use [◀] or [▶] to select <ON> to enable summer time or <OFF> to disable it.
 - If you select <OFF> and press [OK]:
 1. Go to step 13.
 - If you select <ON> and press [OK]:
 1. Go to step 4.
- 4** Press [OK] twice.
- 5** Use [◀] or [▶] to select the month when summer time starts, then press [OK] twice.
- 6** Use [◀] or [▶] to select the week when summer time starts, then press [OK] twice.
- 7** Use [◀] or [▶] to select the day when summer time starts, then press [OK] twice.
- 8** Use the Numeric Keys to enter the time (in 24-hour format) when summer time starts, then press [OK] three times.
- 9** Use [◀] or [▶] to select the month when summer time ends, then press [OK] twice.
- 10** Use [◀] or [▶] to select the week when summer time ends, then press [OK] twice.
- 11** Use [◀] or [▶] to select the day when summer time ends, then press [OK] twice.
- 12** Use the Numeric Keys to enter the time (in 24-hour format) when summer time ends, then press [OK].
- 13** Press [Stop/Reset].

► Guidelines For Entering Numbers, Letters, And Symbols

- 1 Press [**✖**] to switch to uppercase letter mode (:A), lowercase letter mode (:a), or number mode (:1).
- 2 Use the Numeric Keys to enter a character. Press the button repeatedly until the character you want appears.

● **To enter two characters that are under the same button:**

1. Press the Numeric Key, press [**▶**], then press the same Numeric Key again.

● **To enter a space:**

1. Press [**▶**] twice.

In number mode, press [**▶**] once.

● **To delete a character:**

1. Press [**◀**].

● **To delete an entire entry :**

1. Press and hold [**◀**].

Without lowercase letter mode:

Button	Letter mode	Number mode
[1]		1
[2]	ABCabc	2
[3]	DEFdef	3
[4]	GHIghi	4
[5]	JKLjkl	5
[6]	MNOmno	6
[7]	PQRSpqrs	7
[8]	TUVtuv	8
[9]	WXYZwxyz	9
[0]		0
[#]		-. * # ! " , ; : ^ ` _ = / ' ? \$ @ % & + () [] { } < >

With lowercase letter mode:

Button	Uppercase letter mode	Lowercase letter mode	Number mode
[1]			1
[2]	ABCĂĂĂĂĂĂĂÆÇ	abcăăăăăăăæç	2
[3]	DEFĐĚĚĚĚĚ	defďěěěěě	3
[4]	GH I Ĩ Í Î Ï	gh i ĩ í î ï	4
[5]	JKL	jkl	5
[6]	MNOÑŃŎŎŎŎŎŎ	mnoñññññññ	6
[7]	PQRSŔ	pqrsŕ	7
[8]	TUVÚÚÚÚÚ	tuvúúúúú	8
[9]	WXYZÝ	wxyzý	9
[0]			0
[#]	-.*#!";:^_=/!*?@\$%&+()[]{}<>		
[*]	Uppercase letter mode (: A) → Lowercase letter mode (: a) → Number mode (: 1) 		

7 Sending Faxes

► Sending Methods

- 1 Load the document on the Platen Glass or the ADF.
- 2 Press [FAX].
- 3 Adjust the settings for your document as necessary.
- 4 Dial the recipient's number using the Numeric Keys or speed dialing.
- 5 Press [Color] for color sending, or [Black] for black & white sending.

One-Touch Speed Dialing

- 1 Press the One-Touch Speed Dial Key (01-08) that has been assigned the number you want to dial.

Coded Speed Dialing

- 1 Press [Coded Dial].
- 2 Use the Numeric Keys to enter the 2-digit code (00-99) assigned to the number you want to dial.

8 Receiving Faxes

► Receive Modes

If You Want To Receive Only Faxes Automatically With Your Machine, Or You Have A Dedicated Telephone Line For Fax Use Only:

- Select **<FAX ONLY MODE>**.
 - When you receive a fax call: The machine will receive the fax automatically.
 - When you receive a voice call: You will not be able to answer the call.

If You Receive Mainly Voice Calls And Sometimes Faxes, Or You Want To Receive Faxes Manually:

- Select **<MANUAL MODE>**.
 - When you receive a fax call: The telephone will ring. Pick up the handset and if you hear a beep, press [Black] or [Color] on the machine to receive the fax.
 - When you receive a voice call: The telephone will ring. Pick up the handset to answer the call.
 - For remote receiving: If you are far from your machine, dial 25 (the remote receiving ID) on your telephone to receive faxes.

If You Want To Receive Voice Messages On Your Answering Machine And Receive Faxes Automatically:

- Select **<ANS.MACHINE MODE>**.
 - When you receive a fax call: First the answering machine connected to your machine will respond to an incoming call, and then the machine will receive faxes automatically.
 - When you receive a voice call: The answering machine connected to your machine will respond to an incoming call.

If You Want To Receive Faxes Automatically As Well As Voice Calls:

- Select **<FAX/TEL AUTO SW>**.

- When you receive a fax call: The machine will receive the fax automatically.
- When you receive a voice call: The machine will ring. Pick up the handset to answer the call.

If You Have Subscribed To A Distinctive Ring Pattern Detection (DRPD) Service With Your Telephone Company (US only):

- Select **<DRPD>**.

- When you receive a fax call: The machine will ring according to the ring pattern you have chosen and receive the fax automatically.
- When you receive a voice call: The machine will ring according to the ring pattern you have chosen. Pick up the handset to answer the call.

If You Have Subscribed To The Telstra FaxStream™ Duet Service (Australia only) Or The Telecom FaxAbility Service (New Zealand only):

- Select **<NET SW.>**.

- When you receive a fax call: The machine will ring and receive the fax automatically.
- When you receive a voice call: The machine will ring. Pick up the handset to answer the call.

► Setting The Receive Mode

- 1 Press [FAX], then press [Menu].
- 2 Press [OK].
- 3 Use [◀] or [▶] to select the receive mode.
- 4 Press [OK].

9 Maintenance

► Replacing An Ink Tank

- 1 Make sure the power is turned ON.
- 2 Press the Open Button (1) to open the Paper Output Tray (2).

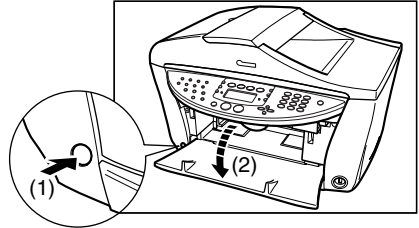

- 3 Lift up the Scanning Unit until it stops.

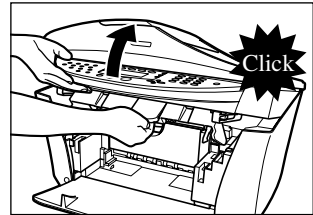

- 4 Open the Inner Cover 1.

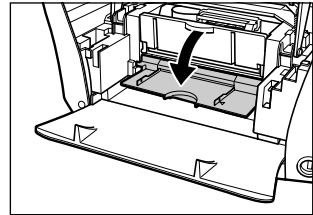

- 5 Open the Inner Cover 2.

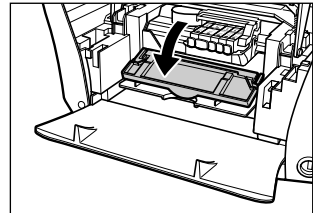

- 6** Press the empty ink tank's tab (1), then remove it from the slot (2).

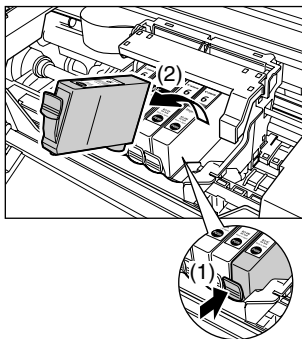

- 7** Remove the new ink tank from its packaging, then pull the orange tape toward the arrow so that the protective film does not remain on the air hole (A). Then hold the ink tank as shown and remove the orange protective cap (B).

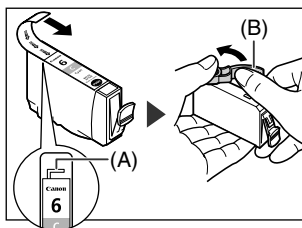

- 8** Insert the ink tank diagonally into the print head.

- 9** If you need to replace another ink tank, repeat steps 6 to 8.

- 10** Close the Inner Cover 2.

- 11** Close the Inner Cover 1.

- 12** Close the Scanning Unit.

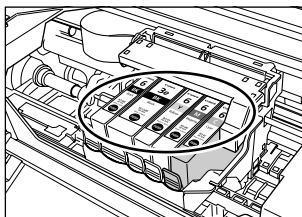
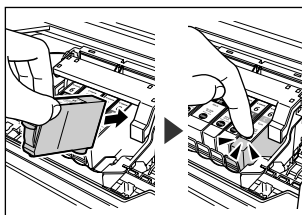

► Maintaining The Print Head

Cleaning The Print Head

- 1 Press [Menu] repeatedly until <MAINTENANCE> appears.
- 2 Use [◀] or [▶] to select <CLEANING> or <HEAD REFRESHING> as necessary.
- 3 Press [OK].

Aligning The Print Head Automatically

- 1 Load A4- or letter-size plain paper in the Auto Sheet Feeder.
- 2 Press [Menu] repeatedly until <MAINTENANCE> appears.
- 3 Use [◀] or [▶] to select <AUTO HEAD ALIGN>, then press [OK].
- 4 The pattern is printed.

This product uses the following copyrighted software:

exit.c Copyright © 1990 The Regents of the University of California.
All rights reserved.

Redistribution and use in source and binary forms are permitted provided that the above copyright notice and this paragraph are duplicated in all such forms and that any documentation, advertising materials, and other materials related to such distribution and use acknowledge that the software was developed by the University of California, Berkeley. The name of the University may not be used to endorse or promote products derived from this software without specific prior written permission.

THIS SOFTWARE IS PROVIDED "AS IS" AND WITHOUT ANY EXPRESS OR IMPLIED WARRANTIES, INCLUDING, WITHOUT LIMITATION, THE IMPLIED WARRANTIES OF MERCHANTABILITY AND FITNESS FOR A PARTICULAR PURPOSE.

environ.c Copyright © 1995, 1996 Cygnus Support.
All rights reserved.

Redistribution and use in source and binary forms are permitted provided that the above copyright notice and this paragraph are duplicated in all such forms and that any documentation, advertising materials, and other materials related to such distribution and use acknowledge that the software was developed at Cygnus Support, Inc. Cygnus Support, Inc. may not be used to endorse or promote products derived from this software without specific prior written permission.

THIS SOFTWARE IS PROVIDED "AS IS" AND WITHOUT ANY EXPRESS OR IMPLIED WARRANTIES, INCLUDING, WITHOUT LIMITATION, THE IMPLIED WARRANTIES OF MERCHANTABILITY AND FITNESS FOR A PARTICULAR PURPOSE.

impure.c Copyright © 1994, 1997 Cygnus Solutions.
string.h All rights reserved.
_ansi.h

Redistribution and use in source and binary forms are permitted provided that the above copyright notice and this paragraph are duplicated in all such forms and that any documentation, advertising materials, and other materials related to such distribution and use acknowledge that the software was developed at Cygnus Solutions. Cygnus Solutions may not be used to endorse or promote products derived from this software without specific prior written permission.

THIS SOFTWARE IS PROVIDED "AS IS" AND WITHOUT ANY EXPRESS OR IMPLIED WARRANTIES, INCLUDING, WITHOUT LIMITATION, THE IMPLIED WARRANTIES OF MERCHANTABILITY AND FITNESS FOR A PARTICULAR PURPOSE.

Quick Start Guide

Canon U.S.A., Inc.

One Canon Plaza, Lake Success, NY 11042, U.S.A.

Canon Inc.

30-2, Shimomaruko 3-chome, Ohta-ku, Tokyo 146-8501, Japan

Canon Australia Pty. Ltd.

1 Thomas Holt Drive, North Ryde, Sydney, N.S.W. 2113, Australia

Canon Singapore Pte. Ltd.

1 Harbour Front Avenue #04-00 Keppel Bay Tower, Singapore 098632

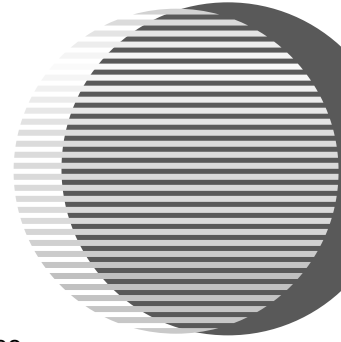

The following ink tanks are compatible with this printer.

For details on ink tank replacement, refer to “Maintenance” in this guide.



BCI-6BK



BCI-3eBK



BCI-6Y



BCI-6M



BCI-6C

Free Manuals Download Website

<http://myh66.com>

<http://usermanuals.us>

<http://www.somanuals.com>

<http://www.4manuals.cc>

<http://www.manual-lib.com>

<http://www.404manual.com>

<http://www.luxmanual.com>

<http://aubethermostatmanual.com>

Golf course search by state

<http://golfingnear.com>

Email search by domain

<http://emailbydomain.com>

Auto manuals search

<http://auto.somanuals.com>

TV manuals search

<http://tv.somanuals.com>