

ENGLISH



Canon PowerShot A550 DIGITAL CAMERA



Before Using the Camera

Shooting

Playback/Erasing

Print/Transfer Settings

Troubleshooting

List of Messages

Appendix

Advanced

Camera User Guide

This guide explains camera features and procedures in detail.

Canon DIGITAL CAMERA PowerShot A550 Advanced Camera User Guide

Canon



Main Features

Shooting

- Avoid the effects of camera shake or blurry subjects when shooting by using a high ISO speed
- Automatically adjusts shooting settings to match particular conditions
- Automatically detects camera orientation with an Intelligent Orientation sensor



Playback

- Plays movies with sound
- Plays back automatically using the Auto Play

Editing

- Records sound memos for still images

Printing

- Makes printing easy with the Print/Share button
- Also supports non-Canon brand PictBridge compliant printers

Uses of Recorded Images

- Effortlessly transfer them to a computer with the Print/Share button

Conventions Used in this Guide

Icons appearing next to, or below titles indicate the shooting modes in which the procedure can be used.

 Shooting/  Playback Mode

Postcard Mode



Shooting Mode

AUTO



SCN



M

- Unavailable shooting modes are shown grayed out.

See *Functions Available in Each Shooting Mode* (p. 119).

- In this guide, the *Basic Camera User Guide* is referred to as the *Basic Guide*, and the *Advanced Camera User Guide* is referred to as the *Advanced Guide*.



: This mark denotes issues that may affect the camera's operation.



: This mark denotes additional topics that complement the basic operating procedures.



You can use SD memory cards, SDHC memory cards and MultiMediaCards with this camera. These cards are collectively called memory cards in this guide.





Use of genuine Canon accessories is recommended.

This product is designed to achieve excellent performance when used with genuine Canon accessories. Canon shall not be liable for any damage to this product and/or accidents such as fire, etc., caused by the malfunction of non-genuine Canon accessories (e.g., a leakage and/or explosion of a battery pack). Please note that this warranty does not apply to repairs arising out of the malfunction of non-genuine Canon accessories, although you may request such repairs on a chargeable basis.

Table of Contents

Items marked with a ★ are lists or charts that summarize camera functions or procedures.

Conventions Used in this Guide	1
Handling Precautions	5
Please Read	5
Safety Precautions	6
Preventing Malfunctions	11
Before Using the Camera – Basic Operations	12
Using the LCD Monitor	12
Information Displayed on the LCD Monitor	13
Using the Viewfinder	16
Power Saving Function	17
★ Menus and Settings	18
★ Menu List	20
Resetting Settings to Their Default Values	24
Formatting Memory Cards	25
Shooting	26
Changing the Recording Pixels and Compression (Still Images)	26
Using the Digital Zoom/ Digital Tele-Converter	28
📷 Continuous Shooting	31
Postcard Mode	32
Embedding the Date in the Image Data	33
Setting the Display Overlays	34
🎬 Movie Shooting	35
Selecting an AF Frame	39
Shooting Hard-to-Focus Subjects (Focus Lock, AF Lock)	40
Locking the Exposure Setting (AE Lock)	42
Locking the Flash Exposure Setting (FE Lock)	43
Switching between Metering Modes	43
Adjusting the Exposure Compensation	44
Shooting in Long Shutter Mode	45

Adjusting the Tone (White Balance)	47
Shooting in a My Colors Mode	49
 Adjusting the ISO Speed	52
Setting the Auto Rotate Function	53
Creating an Image Destination (Folder)	54
Resetting the File Number	56
Playback/Erasing	58
 Magnifying Images	58
 Viewing Images in Sets of Nine (Index Playback)	59
 Jumping to Images	60
Viewing Movies	61
Rotating Images in the Display	63
Attaching Sound Memos to Images	64
Automated Playback (Auto Play)	65
Protecting Images	66
Viewing Images on a TV Set.	67
Erasing All Images	68
Print Settings/Transfer Settings	69
Setting the DPOF Print Settings	69
Setting the DPOF Transfer Settings	74
Troubleshooting	76
Camera	76
When the power is turned on	77
LCD monitor	77
Shooting	79
Shooting Movies	83
Playback	84
Battery	85
TV monitor output	86
Printing with a direct print compatible printer	86
List of Messages	87

Appendix 91

Battery Handling91
Handling the Memory Card93
Using the Power Kits (Sold Separately)95
Using an Externally Mounted Flash (Sold Separately)99
Replacing the Date Battery101
Camera Care and Maintenance103
Specifications104

INDEX 113

★ Functions Available in Each Shooting Mode 119

Handling Precautions

Please Read

Test Shots

Before you try to photograph important subjects, we highly recommend that you shoot several trial images to confirm that the camera is operating and being operated correctly.

Please note that Canon Inc., its subsidiaries and affiliates, and its distributors are not liable for any consequential damages arising from any malfunction of a camera or accessory, including memory cards, that results in the failure of an image to be recorded or to be recorded in a way that is machine readable.

Warning Against Copyright Infringement

Please note that Canon digital cameras are intended for personal use and should never be used in a manner that infringes upon or contravenes international or domestic copyright laws and regulations. Please be advised that in certain cases the copying of images from performances, exhibitions, or commercial properties by means of a camera or other device may contravene copyright or other legal rights even if the image was shot for personal use.

Warranty Limitations

This camera's warranty is only effective in the country of sale. If a problem arises while the camera is in use abroad, please convey it back to the country of sale before proceeding with a warranty claim to a Canon Customer Support Help Desk.

For Canon Customer Support contacts, please see the customer support list supplied with your camera.

Camera Body Temperature

If your camera is used for prolonged periods, the camera body may become warm. Please be aware of this and take care when operating the camera for an extended period.

About the LCD Monitor

The LCD monitor is produced with extremely high-precision manufacturing techniques. More than 99.99% of the pixels operate to specification. Less than 0.01% of the pixels may occasionally misfire or appear as red or black dots. This has no effect on the recorded image and does not constitute a malfunction.

Video Format

Please set the camera's video signal format to the one used in your region before using it with a TV monitor (p. 67).

Language Setting

Please see the *Basic Guide* (p. 8) to change the language setting.

Safety Precautions

- Before using the camera, please ensure that you read the safety precautions described below and in the "Safety Precautions" section of the *Basic Camera User Guide*. Always ensure that the camera is operated correctly.
- The safety precautions noted on the following pages are intended to instruct you in the safe and correct operation of the camera and its accessories to prevent injuries or damage to yourself, other persons and equipment.
- Equipment refers to the camera, battery, battery charger (sold separately) and compact power adapter (sold separately).

Warnings

Equipment

- **Do not point the camera directly at the sun or bright light sources.**

Doing so could damage the camera's CCD or your eyesight.

- **Store this equipment out of the reach of children and infants.**
 - Wrist strap: Placement of the strap around the child's neck could result in asphyxiation.
 - Memory card: It may be swallowed accidentally. If this occurs, contact a doctor immediately.

- **Do not attempt to disassemble or alter any part of the equipment that is not expressly described in this guide.**
- **To avoid the risk of high-voltage electrical shock, do not touch the flash portion of the camera if it has been damaged.**
- **Stop operating the equipment immediately if it emits smoke or noxious fumes.**
- **Do not allow the equipment to come into contact with, or become immersed in, water or other liquids. If the exterior comes into contact with liquids or salt air, wipe it dry with a soft, absorbent cloth.**

Continued use of the equipment may result in fire or electrical shock. Immediately turn the camera power off and remove the camera batteries or unplug the battery charger or compact power adapter from the power outlet.

Please consult your camera distributor or the closest Canon Customer Support Help Desk.

- **Do not use substances containing alcohol, benzine, thinners or other flammable substances to clean or maintain the equipment.**
- **Do not cut, damage, alter or place heavy items on the power cord.**
- **Use only recommended power accessories.**
- **Remove the power cord on a regular periodic basis and wipe away the dust and dirt that collects on the plug, the exterior of the power outlet and the surrounding area.**
- **Do not handle the power cord if your hands are wet.**

Continued use of the equipment may result in fire or electrical shock.

Battery

- **Do not place the batteries near a heat source or expose them to direct flame or heat.**
- **The batteries should not be immersed in water or sea water.**
- **Do not attempt to disassemble, alter or apply heat to the batteries.**
- **Avoid dropping or subjecting the batteries to severe impacts that could damage the casing.**
- **Use only recommended batteries and accessories.**

Use of batteries not expressly recommended for this equipment may cause explosions or leaks, resulting in fire, injury and damage to the surroundings. In the event that a battery leaks and the eyes, mouth, skin or clothing contact these substances, immediately flush with water and seek medical assistance.

- **Disconnect the battery charger and compact power adapter from both the camera and the power outlet after recharging or when not in use to avoid fire and other hazards.**
- **Do not place anything, such as tablecloths, carpets, bedding or cushions, on top of the battery charger while it is charging.**

Leaving the units plugged in for a long period of time may cause them to overheat and distort, resulting in fire.

- **When recharging the Canon AA-size NiMH batteries, use only a specified battery charger.**
- **The compact power adapter is designed for exclusive use with this equipment. Do not use it with other products.**

There is a risk of overheating and distortion which could result in fire or electrical shock.

- **Before you discard a battery, cover the terminals with tape or other insulators to prevent direct contact with other objects.**

Contact with the metallic components of other materials in waste containers may lead to fire or explosions.

Others

- **Do not trigger the flash in close proximity to human or animal eyes. Exposure to the intense light produced by the flash may damage eyesight.**

In particular, remain at least one meter (39 inches) away from infants when using the flash.

- **Keep objects that are sensitive to magnetic fields (such as credit cards) away from the speaker of the camera.**

Such items may lose data or stop working.

Cautions

Equipment

● **Be careful not to bang the camera or subject it to strong impacts or shocks that could lead to injury or damage the equipment when wearing or holding it by the strap.**

● **Do not store the equipment in humid or dusty areas.**

● **Do not allow metal objects (such as pins or keys) or dirt to contact the charger terminals or plug.**

Such conditions could lead to fire, electrical shock or other damage.

● **Avoid using, placing or storing the equipment in places subject to strong sunlight or high temperatures, such as the dashboard or trunk (boot) of a car.**

● **Do not use the equipment in a manner that exceeds the rated capacity of the electrical outlet or wiring accessories. Do not use if the power cord or plug is damaged, or if not fully plugged into the outlet.**

● **Do not use in locations with poor ventilation.**

The above-mentioned can cause leakage, overheating or explosion, resulting in fire, burns or other injuries. High temperatures may also cause deformation of the casing.

● **When not using the camera for extended periods of time, remove the batteries from the camera or battery charger and store the equipment in a safe place.**

If the batteries are left inside the camera, damage caused by leakage may occur.

● **Do not connect compact power adapters or battery chargers to devices such as electrical transformers for foreign travel because it may lead to malfunctions, excessive heat generation, fire, electric shock or injury.**

Flash

- **Do not operate the flash with dirt, dust or other items stuck to the surface of the flash.**
- **Be careful not to cover the flash with your fingers or clothing when shooting.**

The flash may be damaged and emit smoke or noise. The resulting heat build-up could damage the flash.

- **Do not touch the surface of the flash after taking several pictures in rapid succession.**

Doing so could result in burns.

Preventing Malfunctions

Avoid Strong Magnetic Fields

- **Never place the camera in close proximity to electric motors or other equipment generating strong electromagnetic fields.**

Exposure to strong magnetic fields may cause malfunctions or corrupt image data.

Avoid Condensation Related Problems

- **When moving the equipment rapidly from a cold place to a hot place, you can avoid condensation by placing the equipment in an airtight, resealable plastic bag and letting it adjust to temperature changes slowly before removing it from the bag.**

Moving the equipment rapidly from a cold place to a hot place may cause condensation (water droplets) to form on its external and internal surfaces.

If Condensation Forms Inside the Camera

- **Stop using the camera immediately.**

Continued use may damage the equipment. Remove the memory card and batteries or compact power adapter from the camera and wait until the moisture evaporates completely before resuming use.

Before Using the Camera – Basic Operations

Using the LCD Monitor

1 Press .

- The display mode changes as follows with each press.

Shooting Mode ()

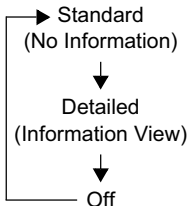

Playback Mode ()

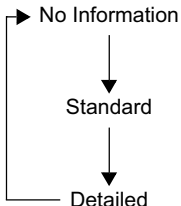

- The shooting information displays for approximately 6 sec. when a setting is changed, regardless of the selected display mode.



- The LCD monitor on or off setting is retained even after the camera power is turned off.
- The LCD monitor does not shut off in the  mode.
- The LCD monitor will not switch to the detailed display while in index playback (p. 59).

Night Display

When shooting in dark conditions, the camera automatically brightens the LCD monitor to suit the brightness of the subject*, making it easier to frame the subject.

* Although noise may appear and the movement of the subject shown on the LCD monitor may appear somewhat jagged, there is no effect on the recorded image. The brightness of the image displayed in the monitor, and the brightness of the actual image recorded will be different.

Information Displayed on the LCD Monitor

Shooting Information (Shooting Mode)

Digital Tele-Converter (p. 28)

Zoom Magnification (p. 28)

Safety Zoom (p. 28)

Spot AE Point Frame (p. 44)

AF Frame (p. 39)

Macro (*Basic Guide* p. 16)

ISO Speed (p. 52)

Low Battery (p. 91)

Flash (*Basic Guide* p. 14)

Drive Mode (p. 31, *Basic Guide* p. 17)

Auto Rotate (p. 53)

Rec Movie Recording (p. 35)

3:2 Guide (p. 34)

Grid Lines (p. 34)

Shooting Mode

(*Basic Guide* pp. 11 – 13)

(p. 35)

Exposure Compensation (p. 44)

Long Shutter Mode (p. 45)

White Balance (p. 47)

My Colors (p. 49)

Metering Mode (p. 43)

Compression (Still image) (p. 27)

Frame Rate (Movies) (p. 38)

Recording Pixels (pp. 26, 38)

(Red)^{*2} Camera Shake (p. 14)

Create Folder (p. 54)

AF Lock (p. 41)

AE Lock (p. 42)

FE Lock (p. 43)

- Stills: Recordable Shots
- Movies: Remaining Time/ Elapsed Time

Exposure Shift Bar (Movie) (p. 37)

Flash^{*2}/
Shutter Speed^{*1} (p. 104)/
Aperture Value^{*1}

*1 Displays when the shutter button is pressed halfway. Since the camera automatically readjusts for the optimal settings when using the flash, settings displayed in shooting information may differ from the actual settings.

*2 Displays when the shutter button is pressed halfway.



If the indicator blinks orange and the camera shake icon  displays, it indicates there is insufficient illumination and a slow shutter speed will be selected. Shoot using the following methods.

- Raise the ISO speed (p. 52).
- Select a setting other than  (flash off).
- Attach the camera to a tripod or other device.

Playback Information (Playback Mode)

■Standard

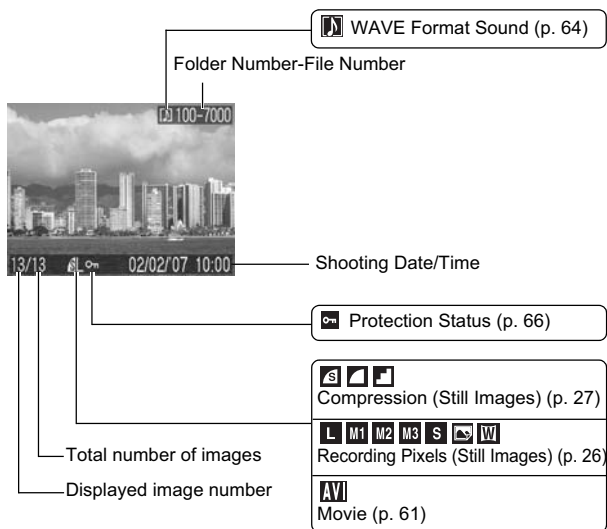

Histogram Function

The histogram is a graph that allows you to judge the brightness of the image. The greater the bias toward the left in the graph, the darker the image. The greater the bias toward the right, the brighter the image.

If the image is too dark, adjust the exposure compensation to a positive value. Similarly, adjust the exposure compensation to a negative value if the image is too bright (p. 44).

Sample Histograms



Dark Image



Balanced Image

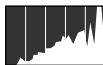

Bright Image

Using the Viewfinder

The viewfinder (*Basic Guide* p. 2) can be used to conserve power by turning the LCD monitor off (p. 12) while shooting.

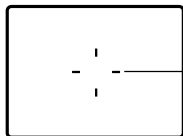

Shows the center of the image

Viewfinder

Power Saving Function

This camera is equipped with a power saving function. The power will shut off in the following circumstances. Press the power button again to restore power.

Shooting Mode	Powers down approximately 3 minutes after the last control is accessed on the camera. The LCD monitor automatically turns off 1 minute* after the last control is accessed even if [Auto Power Down] is set to [Off]. Press any button other than the power button or change the camera orientation to turn the LCD monitor back on.
Playback Mode Connected to a Printer	Powers down approximately 5 minutes after the last control is accessed on the camera.

* This time can be changed.



- The power saving function will not activate during a slide show (Auto Play) or while the camera is connected to a computer.
- The power saving function settings can be changed (p. 23).

Menus and Settings

Menus are used to set the shooting, playback and print settings as well as such camera settings as the date/time and electronic beep.

● FUNC. Menu

● Rec., Play, Print and Set up Menus

FUNC. Menu

Sets many of the functions commonly used during shooting.

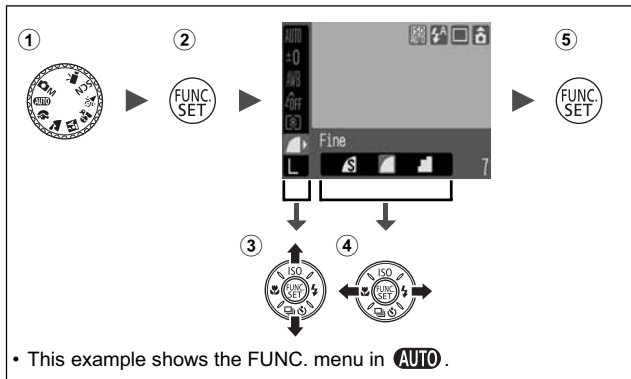

- ① Set the shooting mode dial to the shooting mode you want to use.
- ② Press the FUNC./SET button.
- ③ Use the **↑** or **↓** button to select a menu item.
 - Some items may not be selectable in some shooting modes.
- ④ Use the **←** or **→** button to select an option for the menu item.
 - You can select further options with the **MENU** button for some options.
 - After selecting an option, you can press the shutter button to shoot immediately.
- ⑤ Press the FUNC./SET button.

Rec., Play, Print and Set up Menus

Convenient settings for shooting, playback or printing can be set with these menus.

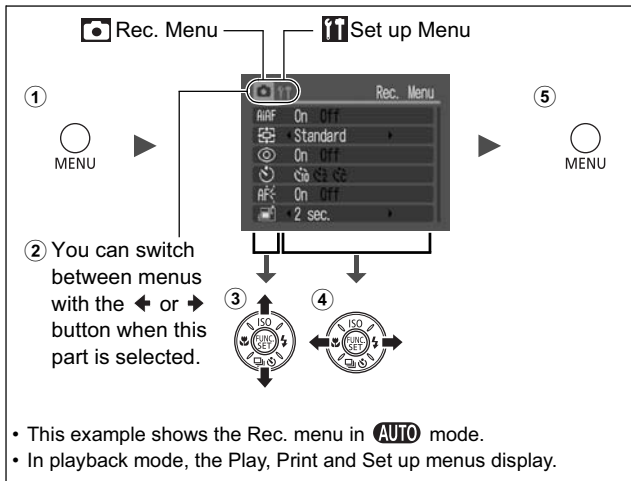











- ① Press the **MENU** button.
- ② Use the \leftarrow or \rightarrow button to switch between menus.
 - You can also use the zoom lever to switch between menus.
- ③ Use the \uparrow or \downarrow button to select a menu item.
 - Some items may not be selectable in some shooting modes.
- ④ Use the \leftarrow or \rightarrow button to select an option.
 - Menu items followed by an ellipsis (...) can only be set after pressing the **FUNC./SET** button to display the next menu. Press the **FUNC./SET** button again to confirm the setting.
- ⑤ Press the **MENU** button.

Menu List

See *Functions Available in Each Shooting Mode* (p. 119).











FUNC. Menu

The icons shown below are the default settings.

	Menu Item	Reference Page
	Special Scene Mode	<i>Basic Guide</i> p. 12
	Movie Mode	p. 35
	Exposure Compensation	p. 44
	Long Shutter Mode	p. 45
	White Balance	p. 47
	My Colors	p. 49
	Metering Mode	p. 43
	Compression (Still Image)	p. 26
	Frame Rate (Movie)	p. 38
	Recording Pixels (Still Image)	p. 26
	Recording Pixels (Movie)	p. 38







Rec. Menu ()

*Default setting

Menu Item	Options	Summary/ Reference Page
 AiAF	On*/Off	p. 39
	Digital Zoom	p. 28
	(Still Image)	Standard*/Off/1.5x/1.9x
	(Movies)	Standard*/Off (in standard movie mode)
 Slow Synchro	On/Off*	<i>Basic Guide</i> p. 15
 Red-Eye	On*/Off	<i>Basic Guide</i> p. 15
	 *	<i>Basic Guide</i> p. 17
	 (Custom)	Delay: 0 – 10*, 15, 20, 30 sec. Shots: 1 – 10* ¹
 AF-assist Beam	On*/Off	–
 Review	Off/2*– 10/seconds/Hold	<i>Basic Guide</i> p. 10
	Disp. Overlay	p. 34
	(Still Image)	Off*/Grid Lines/3:2 Guide/Both
	(Movies)	Off*/Grid Lines
 Date Stamp	Off*/Date/Date & Time	p. 33

*1 Default setting is 3 shots.

Play Menu ()







Menu Item	Reference Page
 Auto Play	p. 65
 Sound Memo	p. 64
 Protect	p. 66
 Rotate	p. 63
 Erase all	p. 68
 Transfer Order	p. 74















Print Menu ()

Menu Item	Reference Page
Print	p. 69
Select Image & Qty.	
Select All Images	
Clear All Selections	
Print Settings	



Set up Menu ()

*Default setting

Menu Item	Options	Summary/Reference Page
 Mute	On/Off*	Set to [On] to silence all operation sounds except for the warning sounds (<i>Basic Guide</i> p. 9).
 Volume	Off / 1 / 2* / 3 / 4 / 5	Adjusts the volume of the start-up sound, operation sound, selftimer sound, shutter sound and playback sound. The volume cannot be adjusted if [Mute] is set to [On].
 Start-up Vol.		Adjusts the volume of the start-up sound when the camera is turned on.
 Operation Vol.		Adjusts the volume of the operation sound that beeps when any button other than the shutter button is pressed.
 Selftimer Vol.		Adjusts the volume of the selftimer sound played 2 sec. before the shutter is released.
 Shutter Volume		Adjusts the volume of the sound played when the shutter releases. The shutter sound does not play when a movie is recording.
 Playback Vol.		Adjusts the volume of movie sounds and sound memos.

Menu Item	Options	Summary/Reference Page
 Start-up Image	On*/Off	Selects whether to display the startup screen when the camera is turned on.
 Power Saving		p. 17
 Auto Power Down	On*/Off	Sets whether or not the camera automatically powers down after a set period of time elapses without the camera being operated.
 Display Off	10 sec./20 sec./ 30 sec./1 min.* / 2 min./3 min.	Sets the length of time before the LCD monitor turns off when no camera operation is performed.
 Date/Time		<i>Basic Guide</i> p. 8
 Format		You can also set a low level format (p. 25).
 File Numbering	Continuous*/Auto Reset	p. 56
 Create Folder		p. 54
Create New Folder	Check mark (On)/ No check mark (Off)	Creates a folder during the next shooting session.
Auto Create	Off*/Daily/Monday-Sunday/Monthly	You can also set an auto creation time.
 Auto Rotate	On*/Off	p. 53
 Lens Retract	1 minute*/ 0 seconds	Sets the lens retraction timing when switching from shooting mode to playback mode.
 Language		<i>Basic Guide</i> p. 8
 Video System	NTSC/ PAL	p. 68
 Print Method	Auto*/ 	p. 24* ¹

Menu Item	Options	Summary/Reference Page
 Reset All		p. 24

- *1 The connection method with the printer can be changed. Although it is normally not necessary to change the setting, select  when borderless printing an image shot in  (Widescreen) mode on wide size paper using Canon compact photo printer SELPHY CP730/CP720/CP710/CP510. As this setting will be stored to memory even when the power is turned off, to print using an image size other than , return the mode to [Auto] (however, the connection method cannot be changed while connected to a printer).

Resetting Settings to Their Default Values







1 (Set up) Menu ► (Reset All).

See Menus and Settings (p. 19).



2 Select [OK] and press .



- Settings cannot be reset when the camera is connected to a computer or to a printer.
- The following cannot be reset.
 - Shooting mode
 - The  (Date/Time),  (Language) and  (Video System) options in the  (Set up) menu (p. 23)
 - White balance data recorded with the custom white balance function (p. 48)

Formatting Memory Cards



You should always format a new memory card or one from which you wish to erase all images and other data.



Please note that formatting (initializing) a memory card erases all data, including protected images and other file types.

1 (Set up) Menu (Format).

See *Menus and Settings* (p. 19).



2 Select [OK] and press .

- To perform a low level format, use the button to select [Low Level Format] and the or button to add a check mark.

- You can stop formatting a card when [Low Level Format] is selected by pressing the **FUNC./SET** button. You can still use a card without problem when formatting is halted, but its data will be erased.



Low Level Format

We recommend you select [Low Level Format] when you think that the recording/reading speed of a memory card has dropped. A low level format may require 2 to 3 minutes with some memory cards.

Changing the Recording Pixels and Compression (Still Images)



Shooting Mode



1 **FUNC. Menu** ► **[L]** *(Compression)/ **[L]** *(Recording Pixels).

See Menus and Settings (p. 18).



* Default setting.

- Use the **←** or **→** button to select recording pixel/compression settings and press the **FUNC./SET** button.





Approximate Values for Recording Pixels

Recording Pixels		Purpose*	
[L] Large	3072 × 2304 pixels	High ↑	Printing to about A3 size (Approx. 297 × 420 mm (11.7 × 16.5 in.))
[M1] Medium 1	2592 × 1944 pixels		Printing to about A4 size (Approx. 210 × 297 mm (8.3 × 11.7 in.)) Printing to about Letter size prints 216 × 279 mm (8.5 × 11 in.)
[M2] Medium 2	2048 × 1536 pixels		Printing to about A5 size (Approx. 149 × 210 mm (5.9 × 8.3 in.))
[M3] Medium 3	1600 × 1200 pixels		Printing postcard-size prints 148 × 100 mm (6 × 4 in.) Printing L-size prints 119 × 89 mm (4.7 × 3.5 in.)
[S] Small	640 × 480 pixels		Low ↓ Sending images as e-mail attachments or shooting more images

 or  Postcard	1600 × 1200 pixels	When printing to postcards (p. 32)
 Widescreen	3072 × 1728 pixels	Printing wide size prints (Images are recorded with 16:9 aspect ratios. Areas not recorded will display as black bars on the LCD monitor.)

* Paper sizes vary according to region.

Approximate Values for Compression Settings

Compression		Purpose
 Superfine	High Quality ↕ Normal	Shoot higher quality images
 Fine		Shoot normal quality images
 Normal		Shoot more images



- See *Image Data Sizes (Estimated)* (p. 110).
- See *Memory Cards and Estimated Capacities* (pp. 109, 110).

Using the Digital Zoom/ Digital Tele-Converter



Shooting Mode

AUTO





* Can only be set in  mode. However, [Digital Tele-converter] cannot be set.

You can combine digital zoom with optical zoom when shooting. The available shooting characteristics and focal lengths (35mm film equivalent) are as follows.

Selection	Focal Length	Shooting Characteristics
Standard	35 – 560 mm	Enables shooting at zoom factors of up to 16x with digital and optical zoom combined.
Off	35 – 140 mm	Enables shooting without digital zoom.
1.5x	52.5 – 210 mm	Digital zoom is fixed at the selected zoom factor, and the focal length shifts to the telephoto end. This enables a faster shutter speed and less chance of camera shake than a shot taken at the same angle of view with [Standard] or [Off].
1.9x	66.5 – 266 mm	



- The digital zoom cannot be used when the LCD monitor is turned off.
- The digital zoom cannot be used in  or  (Postcard), or  (Widescreen) modes.

1 (Rec.) Menu (Digital Zoom) [Standard]*/[Off]/[1.5x]/[1.9x].

See *Menus and Settings* (p. 19).



* Default setting.

- When using [Standard]
See *Shooting With the Digital Zoom*
(see below).
- When using [1.5x] or [1.9x]
See *Shooting With the Digital Tele-Converter* (p. 30).



Shooting With the Digital Zoom

2 Press the zoom lever toward and shoot.

- The combined digital and optical zoom setting will display in the LCD monitor.
- Based on the number of recording pixels set, the Safety Zoom feature calculates the maximum zoom factor beyond which image quality will begin to deteriorate. The digital zoom pauses at this zoom factor for a moment, and  appears on the LCD monitor.
If you press the zoom lever toward  again, you can zoom in even closer. The color of the zoom factor display represents the following.
 - White: The image quality will not deteriorate.
 - Blue: The image quality will deteriorate.
- Press the zoom lever toward  to zoom out.



Shooting With the Digital Tele-Converter

2 Adjust the angle of view with the zoom lever and shoot.

- **T** appears on the LCD monitor.
- Depending on the number of recording pixels set, image quality may deteriorate (**T** and the zoom factor appear in blue).



About the Digital Tele-Converter

The digital tele-converter feature uses digital zoom to achieve the effects of a tele-converter (a lens used for telephoto shooting).



Shooting Mode

AUTO



SCN



In this mode, the camera shoots continuously while the shutter button is held down.

If you use the recommended memory card*, you can shoot continuously (smooth continuous shooting) at a set shooting interval until the memory card is full (pp. 109, 110).

* Recommended Memory Card:

Super high-speed SDC-512MSH memory card (sold separately) to which low-level formatting (p. 25) is conducted immediately before shooting.

- This reflects standard shooting criteria established by Canon. Actual results may vary according to the subject and shooting conditions.
- Even if continuous shooting suddenly stops, the memory card may not be full.

1 Press the button to cycle through continuous shooting settings.

- Each time you press the  button, the continuous shooting settings will change.



* Default setting.

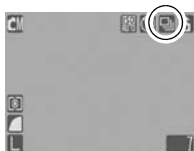

2 Shoot.

- The camera will continue to record successive images while the shutter button is held down. Recording will cease when the shutter button is released.

To Cancel Continuous Shooting

Follow Step 1 to select .



- The interval between shots lengthens when the built-in memory of the camera fills.
- If the flash is used, the interval between shots lengthens because the flash must charge.

Postcard Mode



Shooting Mode

AUTO



You can shoot images with the optimal settings for postcards by composing them inside the print area (width-to-height ratio of approximately 3:2) shown in the LCD monitor.

1

FUNC. Menu ► *(Recording Pixels)

► (Postcard).

See Menus and Settings (p. 18).

* Default setting.

- The recording pixels are set to **M3** (1600 × 1200) and the compression to (Fine).
- The area that will not get printed in postcard size grays out.



The digital zoom or digital tele-converter cannot be used in this mode.



For printing instructions, refer to the *Direct Print User Guide*.

Embedding the Date in the Image Data

You can embed the date in image data when  (Postcard mode) is selected.

1 (Rec.) Menu ► (Date Stamp) ► [Off]*/[Date]/[Date & Time].

See Menus and Settings (p. 19).

* Default setting.

- LCD monitor display

: [Off]

: [Date]/[Date & Time]

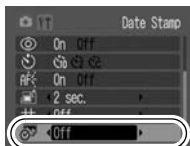

- Ensure that the camera's date/time is set beforehand (p. 23).
- The date stamp cannot be deleted from the image data once it has been set.

Setting the Display Overlays



Shooting Mode

AUTO



*1 Only [Grid Lines] can be set.

You can display vertical and horizontal grid lines, a 3:2 print area guide, or both on the LCD monitor while shooting to help check the position of your subject.

Grid Lines	Displays grid lines to divide the screen into 9 parts. Helps confirm the vertical and horizontal positioning of the subject.
3:2 Guide	Helps confirm the print area for a 3:2 print.*2 Areas outside the printable area are grayed out.
Both	Displays both the grid lines and the 3:2 guide simultaneously.

*2 Images are still recorded at the standard aspect ratio of 4:3.

1

(Rec.) Menu ► (DISP. Overlay) ► [Off]*/
[Grid Lines]/[3:2 Guide]/[Both].

See Menus and Settings (p. 19).

* Default setting.

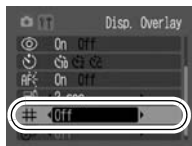

The grid lines and 3:2 guide will not be recorded in the image.



Shooting Mode

AUTO



SCN



The following movie modes are available.

For information on the recording pixels and frame rate in each mode, refer to *Recording Pixels and Frame Rates* (p. 38).

Standard

You can select the recording pixels and frame rate and record until the memory card is full (when a super high-speed memory card is used, such as the recommended SDC-512MSH).

The digital zoom can be used while shooting in this mode (p. 28).

- Maximum Size: 1 GB/movie*

Fast Frame Rate

Use this mode to record fast moving subjects, such as in sports photography.

- Maximum Clip Length: 1 minute

Compact

Since the recording pixels are few and the data size is small, this mode is convenient for sending movies as e-mail attachments or when the memory card capacity is low.

- Maximum Clip Length: 3 minutes



- The recording time will differ according to the memory card used (p. 110).

* Even if the size of the movie data has not reached 1 GB, recording will stop when a shooting time of 1 hour has elapsed. Depending on the volume and data writing speed of the memory card, recording will stop after 1 hour of continuous recording even if the recorded data volume has not reached 1GB.

1 **FUNC. Menu** * **(Standard).**

See Menus and Settings (p. 18).

* Default setting.

- Use the  or  button to select a movie mode and press the **FUNC./SET** button.
- In  mode, you can change the recording pixels and frame rate (p. 38).



2 **Shoot.**

- Pressing the shutter button halfway automatically sets the exposure, focus and white balance settings.
- Pressing the shutter button fully starts recording video and sound simultaneously.
- During shooting the recording time and [●Rec] appear on the LCD monitor.
- Pressing the shutter button fully again stops recording. Recording will stop automatically under the following circumstances.
 - When the maximum recording time elapses
 - When the built-in memory or memory card become full



- You are recommended to use a memory card that has been formatted in your camera to shoot movies (p. 25). The memory card supplied with the camera may be used without further formatting.
- Be careful of the following while recording.
 - Do not touch the microphone (*Basic Guide* p. 1).
 - Do not press any buttons other than the shutter button. The sound that buttons make will be recorded in the movie.
 - The camera will automatically adjust the exposure and white balance to suit the shooting conditions during recording. Please note, however, that the sounds made by the camera automatically adjusting the exposure may also be recorded.
- The focus and optical zoom settings remain fixed for subsequent frames at the values selected for the first frame.
- Do not point the camera at the sun when shooting.



- Before recording, you can set the AE lock (p. 42) and exposure shift.
 1. Press the **ISO** button.

The exposure will lock (AE lock) and the exposure shift bar will appear in the LCD monitor.
 2. Use the **←** or **→** button to adjust the exposure.

Press the **ISO** button again to release the setting. Also, the setting will be canceled if you press the **MENU** button or change the white balance, My Colors or shooting mode settings.
- QuickTime is required to play back movies (Data type: AVI/ Compression method: Motion JPEG) on a computer (Windows 2000 only).



Changing Recording Pixels and Frame Rates (Movies)

You can change the recording pixels and frame rate when the movie mode is set to  (Standard).

1 **FUNC. Menu** * **(Frame Rate)/ * (Recording Pixels).**

See *Menus and Settings* (p. 18).











* Default setting.

- Use the  or  button to select a frame rate/recording pixels and press the **FUNC./SET** button.



Recording Pixels and Frame Rates

Frame rates indicate the number of frames recorded or played back each second. The higher the frame rate, the smoother the appearance of motion.

	Recording Pixels	Frame Rate		
		 60 frames/sec.	 30 frames/sec.	 15 frames/sec.
 Standard	 640 × 480 pixels	—	○*1	○
	 320 × 240 pixels	—	○	○
 Fast Frame Rate*2	 320 × 240 pixels	○	—	—
 Compact*2	 160 × 120 pixels	—	—	○

*1 Default setting.

*2 The recording pixels and frame rate are fixed.



- See *Image Data Sizes (Estimated)* (p. 110).
- See *Memory Cards and Estimated Capacities* (p. 109).

Selecting an AF Frame



Shooting Mode



*Cannot be set in  mode.

The AF frame indicates the area of the composition on which the camera focuses. You can set the AF frame in the following ways.

	On	The camera automatically selects between 9 AF frames to focus on according to the shooting conditions.
	Off	The camera focuses using the center AF frame. This is convenient for ensuring that your intended subject is in focus and for composing images.

1

 **(Rec.) Menu** ►  **(AiAF)** ► **[On]*/[Off].**

See *Menus and Settings* (p. 19).

* Default setting.

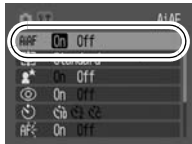

If the shutter button is pressed halfway while the LCD monitor is on, the AF frame appears as follows:

- Green: Shooting preparations complete
- Yellow: Focusing difficulty (AiAF is set to [Off].)
- Off: Focusing difficulty (AiAF is set to [On].)

Shooting Hard-to-Focus Subjects (Focus Lock, AF Lock)



Shooting Mode

AUTO



*Cannot be used in  mode.

It may be difficult to focus on the following types of subjects.



- Subjects with extremely low contrast to the surroundings
- Scenes with a mixture of near and far subjects
- Subjects with extremely bright objects at the center of the composition
- Subjects that are moving quickly
- Subjects through glass: Try to shoot as close to the glass as possible to reduce the chances of light reflecting back off the glass.

Shooting with the Focus Lock

- 1 Aim the camera so that an object at the same focal distance as the main subject is centered in the viewfinder or in the AF frame displayed on the LCD monitor.**
- 2 Press the shutter button halfway to lock the focus.**
- 3 Keep the shutter button pressed while you recompose the image and press the shutter button all the way to shoot the image.**

Shooting with the AF Lock



*Can be operated in  and  modes.

- 1 Turn on the LCD monitor.**
- 2 Aim the camera so that an object at the same focal distance as the main subject is centered in the AF frame.**
- 3 Press and hold the shutter button halfway and press  the button.**
 - The  icon will appear on the LCD monitor.
- 4 Re-aim the camera to compose the shot as desired and shoot.**

To Release the AF Lock

Press the  button.



- When shooting with the focus lock or AF lock using the LCD monitor, setting  (AiAF) to [Off] in the  (Rec.) menu (p. 39) makes shooting easier since the camera focuses using the center AF frame only.
The AF frame will not appear in  mode.
- The AF lock is convenient because you can let go of the shutter button to compose the image. Moreover, the AF lock is still effective after the picture is taken, allowing you to capture a second image with the same focus.

Locking the Exposure Setting (AE Lock)



Shooting Mode

AUTO



M

You can set the exposure and focus separately. This is effective when the contrast is too strong between the subject and background or when a subject is backlit.



You must set the flash to . The AE lock cannot be set if the flash fires.

- 1 Turn on the LCD monitor.**
- 2 Focus on the part of the subject on which you wish to lock the exposure setting.**
- 3 Press and hold the shutter button halfway and press the ISO button.**
 - The icon will display.
- 4 Re-aim the camera to compose the shot as desired and press the shutter button fully.**

To Release the AE Lock

Press the ISO button.



- In mode, AE lock can also be set/canceled (p. 37).
- You can use the FE lock when using the flash (p. 43).

Locking the Flash Exposure Setting (FE Lock)



Shooting Mode



You can lock the flash exposure so that the exposure settings are correctly set regardless of the composition of your subject.

- 1 Turn on the LCD monitor.**
- 2 Press the button and select (flash on).**
- 3 Focus on the part of the subject on which you wish to lock the flash exposure setting.**
- 4 Press and hold the shutter button halfway and press the ISO button.**
 - The flash will pre-fire and icon will display.
- 5 Re-aim the camera to compose the shot as desired and press the shutter button fully.**

Shooting

To Release the FE Lock

Press the ISO button.

Switching between Metering Modes

Shooting Mode



- 1 FUNC. Menu *(Evaluative).**



See Menus and Settings (p. 18).

* Default setting.

- Use the or button to select the metering mode and press the **FUNC./SET** button.



Metering Methods

	Evaluative	Appropriate for standard shooting conditions, including backlit scenes. The camera divides images into several zones for metering. It evaluates complex lighting conditions, such as the position of the subject, the brightness, the direct light, and the backlighting, and adjusts the settings to the correct exposure for the main subject.
	Center Weighted Average	Averages the light metered from the entire frame, but gives greater weight to the subject matter at the center.
	Spot	Meters the area within the spot AE point at the center of the LCD monitor. Use this setting when you want to set the exposure on the subject in the center of the monitor.

Adjusting the Exposure Compensation

Shooting Mode



Adjust exposure to the + side to avoid making the subject too dark when shooting in a backlit situation or against a bright background, and adjust exposure to the – side to avoid making the subject too light when shooting at night or with a dark background.

1 Turn on the LCD monitor.

2 FUNC. Menu ► * (Exposure Compensation).

See Menus and Settings (p. 18).

* Default setting.

- Use the ◀ or ▶ button to adjust the exposure compensation and press the FUNC./SET button.



To Cancel the Exposure Compensation

Follow Step 2 to restore the compensation value to [0].



In mode, the exposure shift can be set/canceled (p. 37).

Shooting in Long Shutter Mode



Shooting Mode



You can set the shutter speed to a slow setting to make dark subjects appear brighter.

1 FUNC. Menu ► * (Exposure Compensation)



See Menus and Settings (p. 18).

* Default setting.



2 Use the or button to select the shutter speed ► .





- The higher the value, the brighter the image and the lower the value, the darker the image.
- If you press the **MENU** button at this point, you will return to the Exposure Compensation setting screen.





- This setting is reset once the camera is turned off.
- The nature of CCDs is such that noise in the recorded image increases at long shutter speeds. This camera, however, applies special processing to images shot at shutter speeds slower than 1.3 seconds to eliminate the noise, thereby producing high-quality images. A certain amount of processing time, however, may be required before the next image can be shot.





- Use the LCD monitor to confirm that the image was recorded at the desired brightness.
- Please note that camera shake becomes a factor at low shutter speeds. Shoot with the camera attached to a tripod.
- Use of the flash may result in an over-exposed image. If this occurs, shoot with the flash set to .
- The following are unavailable:
 - Exposure Compensation
 - Metering
 - AE Lock
 - FE Lock
 - ISO speed: , 
 - Flash: 
 - Slow Synchro

Adjusting the Tone (White Balance)

Shooting Mode

AUTO





Normally, the  (Auto) white balance setting selects an optimal white balance. When the  (Auto) setting cannot produce natural looking colors, change the white balance using a setting appropriate for the light source.

1 FUNC. Menu * (Auto).





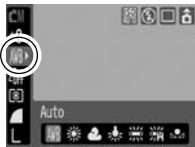

See Menus and Settings (p. 18).

* Default setting.



- Use the  or  button to select a white balance setting and press the FUNC./SET button.



White Balance Settings



	Auto	Settings are automatically set by the camera.
	Day Light	For recording outdoors on a bright day.
	Cloudy	For recording under overcast, shady or twilight skies.
	Tungsten	For recording under tungsten and bulb-type 3-wavelength fluorescent lighting.
	Fluorescent	For recording under warm-white, cool-white or warm-white (3-wavelength) fluorescent lighting.
	Fluorescent H	For recording under daylight fluorescent, or daylight fluorescent-type 3-wavelength fluorescent lighting.
	Custom	For recording with the optimal white balance data retained in the camera from a white-colored object, such as white paper or cloth.



The white balance setting cannot be adjusted when  or  is selected for My Colors.

Using the Custom White Balance

You can set a custom white balance to obtain the optimal setting for the shooting conditions by having the camera evaluate an object, such as a piece of white paper or cloth, or a photo-quality gray card that you wish to establish as the standard white color.

In particular, take a  (Custom) white balance reading for the following situations that are difficult for the  (Auto) setting to detect correctly.

- Shooting close-ups (Macro)
- Shooting subjects of monotone color (such as sky, sea or forest)
- Shooting with a particular source of light (such as a mercury-vapor lamp)

1 **FUNC. Menu** ► ***(Auto)** ► **(Custom).**

See Menus and Settings (p. 18).



* Default setting.



2 **Aim the camera at a piece of white paper or cloth and press** **.**

- If you are viewing it with the LCD monitor, ensure that the center frame is completely filled with the white image. If you are using the optical viewfinder, ensure that the entire field is filled. However, the center frame will not appear when using the digital zoom.



- You are recommended to set the shooting mode to  and the exposure compensation setting to $[\pm 0]$ before setting a custom white balance. The correct white balance may not be obtained when the exposure setting is incorrect (image appears completely black or white).
- Shoot with the same settings as when reading the white balance data. If the settings differ, the optimal white balance may not be set. In particular, the following should not be changed.
 - ISO Speed
 - Flash: Setting the flash to on or off is recommended. If the flash fires when reading the white balance data with the flash set to  (Auto), make sure that you also use the flash when you shoot.

Shooting in a My Colors Mode

Shooting Mode

AUTO









SCN



You can change the look of an image when it is shot.

My Colors Settings

	My Colors Off	Records normally.
	Vivid	Emphasizes the contrast and color saturation to record bold colors.
	Neutral	Tones down the contrast and color saturation to record neutral hues.
	Sepia	Records in sepia tones.
	B/W	Records in black and white.
	Custom Color	Customize contrast, sharpness, and saturation.

1 **FUNC. Menu** ► * (**My Colors Off**).

See *Menus and Settings* (p. 18).

* Default setting.

- Use the ◀ or ▶ button to select a My Colors mode.

-  **Mode**

See *Setting the Camera to a Custom Color Mode* (p. 51).

- **Modes other than** 

Press the **FUNC./SET** button. The display will return to the shooting screen and you can shoot.

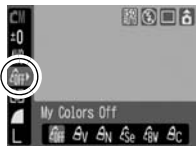

2 **Shoot.**

Setting the Camera to a Custom Color Mode

1 (Custom Color) .

See Menus and Settings (p. 18).



2 Use the or button to select [Contrast], [Sharpness] or [Saturation] and the or button to adjust it.

- The altered color will display.

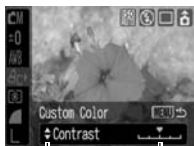

Select an item

Adjust

3 .

- This completes the setting.

If you press the **MENU** button at this point, you will return to the screen where you can select a My Colors mode.



Raise the ISO speed to use a fast shutter speed when you wish to reduce the effects of camera shake or avoid blurry subjects, or to turn the flash off when shooting in a dark area.

1 Press the ISO button to cycle through ISO settings.

- You can advance to the next option each time you press the button: * / / / / / / .

* Default setting.

- When in shooting mode, only or can be selected.
- and are not available in long shutter mode (p. 45).
- Selecting (Auto) sets the optimal ISO speed according to the light level when shooting. Since the ISO speed setting will automatically be raised in dark places, the camera will select a faster shutter speed and reduce the chances of camera shake.
- Selecting (High ISO Auto)* sets the sensitivity to a higher value than the setting. This sets the shutter speed faster, reducing the potential for camera shake or blurry subjects compared with the setting.

* Noise in the recorded image may be higher than for the setting.



When the camera is set to or and you press the shutter button halfway, the camera will set and display the ISO speed. This ISO speed will also appear in the playback information.

Setting the Auto Rotate Function

Shooting Mode



      

Your camera is equipped with an Intelligent Orientation sensor that detects the orientation of an image shot with the camera held vertically and automatically rotates it to the correct orientation when viewing it in the LCD monitor.

1 (Set up) Menu ► (Auto Rotate) ► [On]* / [Off].

See *Menus and Settings* (p. 19).

* Default setting.

- When the Auto Rotate function is set to [On] and the LCD monitor is set to the detailed display mode during shooting,  (normal),  (right end is down) or  (left end is down) will appear in the display.



- This function may not operate correctly when the camera is pointed straight up or down. Check that the arrow  is pointing in the right direction and if it is not, then set the Auto Rotate function to [Off].
- Even if the Auto Rotate function is set to [On], the orientation of images downloaded to a computer will depend upon the software used to download the images.



When the camera is held vertically to shoot, the Intelligent Orientation sensor judges the upper end to be “up” and the lower end to be “down”. It then regulates the optimal white balance, exposure and focus for vertical photography. This function operates regardless of the on/off status of the Auto Rotate function.

Setting the Day or Time for Automatic Folder Creation

2 Select a day for the [Auto Create] option and a time in the [Time] option .

-  displays when the specified time arrives. The symbol will cease to display after the new folder is created.

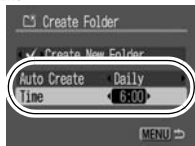

Up to 2000 images can be saved into one folder. A new folder will automatically be created when you record more than that number even if you are not creating new folders.

Resetting the File Number



Shooting Mode



The images you shoot are automatically assigned file numbers. You can select how the file number is assigned.

1 **[i] (Set up) Menu** ▶ **No. (File Numbering)** ▶ **[Continuous]*/[Auto Reset].**

See Menus and Settings (p. 19).

* Default setting.

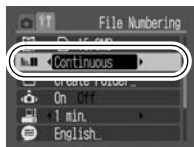

File Number Reset Function

Continuous	<p>A number one higher than the last one recorded is assigned to the next image. This is convenient for managing all your images together on a computer because you avoid file name duplication when changing folders or memory cards*.</p> <p>* When a blank memory card is used. If a memory card with recorded data is used, the 7-digit number for the last recorded folder and image is compared with the last one on the card, and the larger of the two is utilized as the basis for new images.</p>
Auto Reset	<p>The image and folder number are reset to the starting value (100-0001)*. This is convenient for managing images on a folder-by-folder basis.</p> <p>* When a blank memory card is used. If a memory card with recorded data is used, the number following the 7-digit number for the last recorded folder and image on the card is utilized as the basis for new images.</p>

File and Folder Numbers

Recorded images are assigned consecutive file numbers starting with 0001 and ranging up to 9999, while folders are assigned numbers starting with 100 and ranging up to 999. Up to 2,000 images can be saved into a single folder.

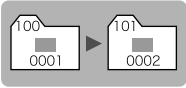
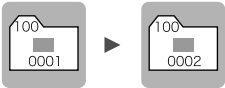
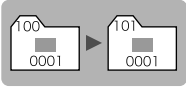
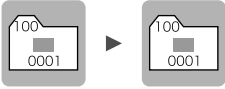
	New Folder Created	Memory Card Exchanged for Another
Continuous	<p>Memory Card 1</p> 	<p>Memory Card 1 Memory Card 2</p> 
Auto Reset	<p>Memory Card 1</p> 	<p>Memory Card 1 Memory Card 2</p> 

- Images may be saved to a new folder when there is insufficient free space even if the total number of images in a folder is less than 2,000 because the following types of images are always saved together into the same folder.
 - Images from continuous shooting
 - Self-timer images (custom)
- Images cannot be played back when the folder numbers are duplicated or image numbers are duplicated within folders.
- Please refer to the *Software Starter Guide* for information regarding folder structures or image types.

Please also see the *Basic Camera User Guide* (p. 19).

Q Magnifying Images





1 Press the zoom lever toward .

-  will display and a magnified portion of the image will display.
- Images can be magnified up to a factor of approximately 10x.



Approximate Location of the Displayed Area

2 Use the , , or button to move around the image.

- If you press the **FUNC./SET** button while in magnified display, the camera switches to image advance mode and  will display. You can use the  or  button to advance to the next or previous image at the same level of magnification. The image advance mode is cancelled when you press the **FUNC./SET** button again.
- You can change the magnification level with the zoom lever.

To Cancel the Magnified Display

Press the zoom lever toward . (You can also cancel it immediately by pressing the **MENU** button.)







Movie frames and index playback images cannot be magnified.

Viewing Images in Sets of Nine (Index Playback)





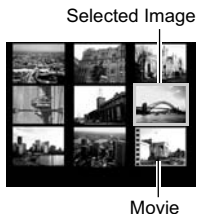

1 Press the zoom lever toward .

- Up to nine images can be viewed at once in index playback.
- Use the , ,  or  button to change the image selection.



Switching between Sets of Nine Images

The jump bar will display if you press the zoom lever toward  while in index playback and you can switch the display between sets of nine images.

- Use the  or  button to move to the previous or next set of nine images.
- Hold the **FUNC./SET** button down and press the  or  button to jump to the first or last set.







To Return to Single Image Playback

Press the zoom lever toward .

Jumping to Images



When you have many images recorded onto a memory card, it is handy to use the five search keys below to jump over images to find the object of your search.

	Jump 10 Images	Jumps over 10 images at a time.
	Jump 100 Images	Jumps over 100 images at a time.
	Shot Date	Jumps to the first image of each shooting date.
	Movie	Jumps to a movie.
	Folder	Jumps to the first image of each folder.

1 **In single image playback mode, press the button.**

- The camera will switch to jump search mode.
- The screen sample will vary slightly according to the search key.



Location of image
currently being displayed

Number of images
matching search key

2 **Use the or button to select a search key and press the or button.**

To Return to Single Image Playback

Press the **MENU** button.



Movies cannot be played in the index playback mode.



1 Display a movie and press



- Images with a **SET**  icon are movies.











Movie Control Panel

Volume Level _____
(Adjust it with the  or  button)

2 Select (Play) and press .

- The movie will pause if you press the **FUNC./SET** button during playback. It will resume when you press the button again.
- When playback ends, the movie stops at the last frame displayed. Press the **FUNC./SET** button to display the movie control panel.
- If playback was halted partway through in the prior viewing session, playback will resume from the first frame.

Operating the Movie Control Panel

	Ends playback and returns to single image playback
	Prints (An icon will display when a printer is connected. See the <i>Direct Print User Guide</i> for details.)
	Play
	Slow Motion Playback (You can use the ◀ button to slow down or the ▶ button to speed up playback.)
	Displays the first frame
	Previous Frame (Rewinds if the FUNC./SET button is held down.)
	Next Frame (Fast Forwards if the FUNC./SET button is held down.)
	Displays the last frame



- Use the television's controls to adjust the volume when playing a movie on a TV set (p. 67).
- The sound cannot be played in slow motion playback.

Rotating Images in the Display



Images can be rotated clockwise 90° or 270° in the display.



Original

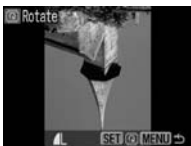

90°



270°

1 (Play) Menu

See Menus and Settings (p. 19).



2 Use the **←** or **→** button to select an image to rotate and press to rotate it.

- Cycle through the 90°/270°/original orientations with each press of the **FUNC./SET** button.
- This also can be set in the index playback mode.



- Movies cannot be rotated.
- When images are downloaded to a computer, the orientation of images rotated by the camera will depend upon the software used to download the images.

Attaching Sound Memos to Images

In playback mode (including single image playback and index playback), you can attach sound memos (up to 1 min.) to an image. The sound data is saved in the WAVE format.

1 (Play) Menu .

See Menus and Settings (p. 19).

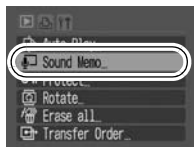

2 Use the or button to select an image to which to attach a sound memo and press



- The sound memo control panel will display.



3 Select (Record) and press .

- The elapsed time and the remaining time display.
- Pressing the **FUNC./SET** button pauses the recording. Pressing it again resumes recording.
- Up to 1 minute of recordings can be added to any one image.







Sound Memo
Panel

Elapsed Time/
Remaining Time

Volume
(Adjust it with the  or  button)

Sound Memo Panel

	Exit
	Record
	Pause
	Play
	Erase Select [Erase] in the confirmation screen and press the FUNC./SET button.



- You cannot attach sound memos to movies.
- Sound memos for protected images cannot be erased.

Automated Playback (Auto Play)

Use this feature to automatically play back all of the images in the memory card. The LCD monitor displays each image for approximately 3 seconds.

1 (Play) Menu .

See Menus and Settings (p. 19).

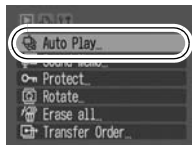

2 Press .

- During automated playback, the following functions are possible:
 - Pausing/resuming the Auto Play: Press the **FUNC./SET** button
 - Fast forwarding/rewinding: Press the **◀** or **▶** button (hold down the button to switch between images more rapidly)
 - Stopping the Auto Play: Press the **MENU** button

Protecting Images

You can protect important images and movies from accidental erasure.

1 (Play) Menu .

See Menus and Settings (p. 19).

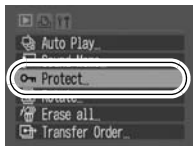

2 Use the **◀** or **▶** button to select an image to protect and press .

- Pressing the **FUNC./SET** button again cancels the setting.
- You can also protect images in the index playback mode.



Protection Icon

Viewing Images on a TV Set



You can play back images on a television with the supplied AV cable.

1 Turn off the camera and the TV.

2 Connect the AV cable to the camera's A/V OUT terminal.

- Slip your fingernail under the lower end of the camera's terminal cover, lift it open and plug the interface cable in all the way.

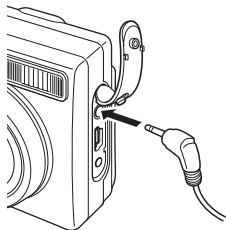

3 Plug the other ends of the AV cable to the VIDEO IN and AUDIO IN jacks on the TV.

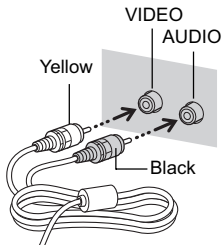

4 Turn on the TV and switch it to video mode.

5 Turn on the camera.



- When the camera is set to shooting mode, you can take pictures while displaying images on the television.
- The video output signal can be switched (NTSC or PAL) to accommodate different regional standards (p. 23). The default setting varies between regions.
 - NTSC: Japan, U.S.A., Canada, Taiwan and others
 - PAL: Europe, Asia (excluding Taiwan), Oceania and others

If the video system is set incorrectly, the camera output may not display properly.

Erasing All Images



- Note that erased images cannot be recovered. Exercise adequate caution before erasing an image.
- Protected images cannot be erased with this function.

1

 **(Print) Menu** .

See *Menus and Settings* (p. 19).

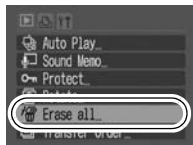

2

Select [OK] and press .

- To exit instead of erasing, select [Cancel].



Please format the memory card when you want to erase not only image data but also all the data contained on the memory card (p. 25).

Print Settings/Transfer Settings

Setting the DPOF Print Settings

You can select images on a memory card for printing and specify the number of print copies in advance using the camera. The settings used on the camera comply with the Digital Print Order Format (DPOF) standards. This is extremely convenient for printing on a direct print compatible printer, or for sending the images to a photo developing service that supports DPOF.

The  icon may display for a memory card with print settings set by a different DPOF-compliant camera. These settings will be overwritten by those set by your camera.

Single Images

1

 (Print) Menu ► [Select Images & Qty.] ► 

See Menus and Settings (p. 19).

- Selecting [Clear All Selections] cancels all print settings.



2 Use the ← or → button to select images for printing.

- Selection methods differ for the Print Type settings (p. 72).
 - Standard ()/Both ()
Select an image, press the **FUNC./SET** button and use the ↑ or ↓ button to select the number of print copies (up to 99).
 - Index ()
Select an image and press the **FUNC./SET** button to select or deselect it.
- You can also select images in the index playback mode.
- If the camera is connected to a printer, the  button will light in blue while images are being selected. At this time, press the  button, confirm that [Print] is selected, and when the **FUNC./SET** button is pressed, printing will begin.

Number of Print Copies





Index Print Selection



All the Images on a Memory Card

1 (Print) Menu [Select All Images] .

See *Menus and Settings* (p. 19).

- One copy of every image will be set to print.
- Selecting [Clear All Selections] cancels all print settings.
- When the camera is connected to a printer, the  button will light in blue. At this time, press the  button, confirm that [Print] is selected, and when the **FUNC./SET** button is pressed, printing will begin.

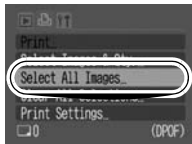

2 **Select [OK] and press** .



- The output of some printers or photo developing services may not reflect the specified print settings.
- Print settings cannot be set for movies.









- Images are printed in order according to the file number.
- A maximum of 998 images can be selected.
- When [Print Type] is set to [Both], the number of copies can be set. When it is set to [Index], the number of copies cannot be set (only one copy will be printed).

Setting the Print Style

After setting the print style, select the images for printing. The following settings can be selected.

*Default setting

 Print Type	Standard*		Prints one image per page.
	Index		Prints the selected images together at a reduced size in an index format.
	Both		Prints the images in both the standard and index formats.
<input checked="" type="checkbox"/> Date (On/Off*)			Adds the date to the print.
 File No. (On/Off*)			Adds the file number to the print.
 Clear DPOF data (On*/Off)			Clears all print settings after the images print.



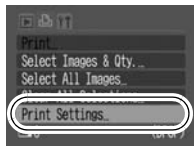

1 (Print) Menu ► [Print Settings] ► .

See Menus and Settings (p. 19).



2 Use the **↑** or **↓** button to select (Print Type), (Date), (File No), (Clear DPOF data) and then use the **←** or **→** button specify the settings.



- The Date and File No. settings change according to the Print Type as follows.
 - Index
 - ☑ (Date) and  (File No.) cannot be set to [On] at the same time.
 - Standard or Both
 - ☑ (Date) and  (File No.) can be set to [On] at the same time, however, the printable information may vary between printers.
- Images dated using  (Postcard Date Imprint mode) (p. 33) are always printed with the date, regardless of the ☑ (Date) setting. As a result, if ☑ (Date) is also set to [On], the date will end up being printed twice on these images.
- Dates print in the style specified in the  (Date/Time) menu (p. 23, *Basic Guide* p. 8).

Setting the DPOF Transfer Settings

You can use the camera to specify settings for images before downloading to a computer. Refer to the *Software Starter Guide* for instructions on how to transfer images to your computer. The settings used on the camera comply with the Digital Print Order Format (DPOF) standards.

The  icon may display for a memory card with transfer settings set by a different DPOF-compliant camera. These settings will be overwritten by those set by your camera.

1 (Play) Menu .

See *Menus and Settings* (p. 19).



Single Images

2 Select [Order] and press .

- Selecting [Reset] cancels all transfer order settings.



3 Use the ← or → button to select an image to transfer and press .

- Pressing the **FUNC./SET** button again deselects the setting.
- You can also select images in the index playback mode.

Transfer Selection



All the Images on a Memory Card

2 Select [Mark all] and press .

- Selecting [Reset] cancels all transfer order settings.



3 Select [OK] and press .



- Images are transferred in order according to the file number.
- A maximum of 998 images can be selected.

Troubleshooting

Camera

Camera will not operate.

Power is not turned on.	● Press the power button (<i>Basic Guide</i> p. 9).
Memory card slot/battery cover is open.	● Confirm that the memory card slot/ battery cover is securely closed (<i>Basic Guide</i> p. 5).
Batteries are loaded in the wrong direction.	● Reload the batteries in the correct direction (<i>Basic Guide</i> p. 5).
Batteries are not the right type.	● Use only unused AA-size alkaline batteries or Canon AA-size NiMH batteries (p. 91).
Battery charge is low and the camera will not operate. ("Change the batteries" message displays).	● Replace the camera batteries with two unused or fully charged batteries (<i>Basic Guide</i> p. 5). ● Use the AC Adapter Kit ACK800 (sold separately) (p. 98).
Poor contact between camera and battery terminals.	● Wipe the battery terminals with a clean dry cloth. ● Reload the batteries several times.

Sounds come from the camera interior.

The camera's horizontal/ vertical orientation was changed.	● The camera's orientation mechanism is operating. There is no malfunction.
--	---

When the power is turned on

“Card locked!” message appears.

The SD memory card or SDHC memory card's write protect tab is set to “Write protect”.

- When recording to, erasing from or formatting the memory card, slide the write protect tab upward (p. 93).

The Date/Time menu appears.

The lithium coin battery charge is low.

- Replace the lithium date battery (p. 101).

LCD monitor

Nothing displays.

The LCD monitor is set not to display.

- Press the **DISP.** button to turn on the LCD monitor (p. 12).

The display darkens.

The image in the LCD monitor will darken in strong sunlight or bright light.

- This is a normal occurrence in devices containing CCDs and does not constitute a malfunction. This image will not be recorded when shooting still images, but it will be recorded when shooting movies.

Display flickers.

Display flickers when shot under fluorescent lighting.

- This is not a camera malfunction (flickering recorded in movies, but not in still images).

A bar of light (red, purple) appears on the LCD

Sometimes appears when shooting a bright subject, such as the sun or other light source.

- This is a normal occurrence in devices containing CCDs and does not constitute a malfunction. This bar of light will not be recorded when shooting still images, but it will be recorded when shooting movies.

appears.

A slow shutter speed has likely been selected because of insufficient lighting.

- Raise the ISO speed (p. 52).
- Set the flash to any setting other than  (flash off) (*Basic Guide* p. 14).
- Set the self-timer and secure the camera to something, such as a tripod.

appears.

This displays when using a memory card that has print settings or transfer settings set by other DPOF-compliant cameras.

- These settings will be overwritten by those set by your camera (p. 69).

Noise displays./Subject's movements are irregular.



Camera automatically lightened the image displayed on the LCD monitor to make it easier to see when shooting in a dark area (p. 12).

- There is no effect on the recorded image.

Shooting

Shooting

Mode is set to  (playback).

- Press the shutter button halfway, or press / button to switch to the shooting mode (*Basic Guide* p. 7).

Flash is charging.

- When the flash is charged, the indicator will light orange. Shooting is now possible (*Basic Guide* p. 4).

Memory card is full.

- Insert a new memory card (*Basic Guide* p. 5).
- If required, download the images to a computer and erase them from the memory card to make space.

Memory card is not formatted correctly.

- Format the memory card (p. 25).
- If reformatting does not work, the memory card logic circuits may be damaged. Consult the nearest Canon Customer Support Help Desk.

SD memory card or SDHC memory card is write protected.

- Slide the write protect tab upward (p. 93).

Image seen in viewfinder vs. recorded image.

Usually the recorded image contains more of the scene than is seen in the viewfinder.

- Confirm the actual image size with the LCD monitor. Use the LCD monitor when taking close-up shots (p. 12).

Image is blurred or out of focus.

The camera moves when the shutter button is pressed.	● Confirm the procedures in “  appears” (p. 78).
AF-assist Beam is set to [Off].	● In dark places where it is difficult for the camera to focus, the AF-assist Beam will emit to assist focusing. As the AF-assist Beam will not function when turned off, set it [On] to activate it (p. 21). Take care not to obstruct the AF-assist Beam with your hand when used.
Subject is out of focal range.	● Shoot with the subject at the correct focusing distance (p. 104).
The subject is hard to focus on.	● Use the focus lock or AF lock to shoot (p. 40).

Subject in recorded image is too dark.

Insufficient light for shooting.	● Set the flash to  (Flash on) (<i>Basic Guide</i> p. 14).
The subject is underexposed because the surroundings are too bright.	● Set the exposure compensation to a positive (+) setting (p. 44). ● Use the AE lock or spot metering function (pp. 42, 44).
Subject is too far away for flash to reach.	● Shoot within correct flash range of the subject when using the built-in flash (p. 105). ● Raise the ISO speed and then shoot (p. 52).

Subject in recorded image is too bright, or image flashes white.

Subject is too close, making the flash too strong.	● Shoot within correct flash range of the subject when using the built-in flash (p. 105).
--	---

The subject is overexposed because the surroundings are too dark.

- Set the exposure compensation to a negative (-) setting (p. 44).
- Use the AE lock or spot metering function (pp. 42, 44).

Too much light is shining directly into the camera, or is being reflected off the subject.

- Change the shooting angle.

Flash is set to on.





- Set the flash to  (Flash off) (*Basic Guide* p. 14).

Image contains noise.

ISO speed is too high.

- Higher ISO speeds or  may increase image noise. For higher image quality, use as low an ISO speed as possible (p. 52).
- In , , and  modes in the mode, the ISO speed increases and noise can appear.

White dots appear on the image.

Light from the flash has reflected off dust particles or insects in the air. This is particularly noticeable when shooting at wide angle settings.

- This is a phenomenon that occurs with digital cameras and does not constitute a malfunction.

Eyes appear red.

Light is reflected back from the eyes when the flash is used in dark areas.

- Shoot with  (Red-Eye) set to [On] (*Basic Guide* p. 15). For this mode to be effective, the subject must be looking right at the red-eye reduction lamp. Try asking them to look directly at the lamp.
- Even better results can be obtained by increasing the lighting in indoor settings or approaching closer to the subject. The shutter will not activate for approximately 1 second after the red-eye reduction lamp fires in order to improve the effect.

Continuous shooting slows down.

The memory card's performance has dropped.

- To enhance the continuous shooting performance, you are recommended to low level format the memory card in the camera after you save all its images to your computer (p. 25).

Recording images to memory card takes a long time.

Memory card was formatted in another device.

- Use a memory card formatted in your camera (p. 25).

Lens will not retract.

Memory card slot cover/ battery cover was opened with power on.

- After closing the memory card slot/ battery cover, turn the power on then back off (*Basic Guide* p. 5).

Shooting Movies

The recording time may not display properly or shooting may stop unexpectedly.

The following types of memory cards are used.

- Slow recording cards.
- Cards formatted on a different camera or a computer.
- Cards which have had images recorded and erased repeatedly.

- Although the recording time may not display properly during shooting, the movie will be recorded correctly on the memory card. Recording time will display properly if you format the memory card in this camera (excluding slow recording memory cards) (p. 25).

“!” displays on the LCD monitor in red and shooting automatically stopped.

There is insufficient free space in the camera's builtin memory.

- Try the following procedures.
 - Format the card with a low level format before shooting (p. 25)
 - Lower the recording pixels or the frame rate (p. 38)
 - Use a high-speed memory card (SDC-512MSH, etc.)

Zoom does not operate.

Zoom lever was pressed while shooting in movie mode.

- Operate the zoom before shooting in movie mode (*Basic Guide* p. 14). Note the digital zoom is available while shooting, but only in Standard movie mode.

Playback

Cannot play back.

You attempted to play back images shot with another camera or images edited with a computer.

- Computer images that cannot be played back may play back if they are added to the camera using the supplied software program ZoomBrowser EX or ImageBrowser. See *ZoomBrowser EX/ImageBrowser Software User Guide (PDF)*.

File name was changed with a computer or file location was changed.

- Set the file name or location on the file format/structure of the camera. (Refer to the *Software Starter Guide* for details).

Movies do not play back correctly.

Movies recorded with high recording pixels and frame rates may momentarily stop playing if played on slow reading memory cards.

You may experience frame dropping and audio breakup when playing back a movie on a computer with insufficient system resources.

Movies recorded at the  (Fast Frame Rate) setting and with the video signal set to the PAL format, may play back with a frame rate lower than the recorded one when output to a TV or video. You can play every frame by using the slow motion playback.

- To check the images at the original frame rate, you are recommended to play the movie back on the camera's LCD monitor or on a computer.

Reading images from memory card is slow.

Memory card was formatted in another device.

- Use a memory card formatted in your camera (p. 25).

Battery

Batteries consumed quickly.

Batteries are not the right type.

- Use only unused AA-size alkaline batteries or Canon AA-size NiMH batteries (p. 91).

Battery capacity drops due to low ambient temperatures.

- If shooting in a cold location, warm the batteries such as by placing them in your pocket before using them.

Battery terminals are dirty.

- Wipe the terminals well with a dry cloth before use.
- Reload the batteries several times.

If using Canon AA-size NiMH batteries

As the batteries have not been used for over a year, their recharging capacity has decreased.

- Their charging performance should return to normal after fully recharging and depleting them over several times.

Battery life has been exceeded.

- Replace both batteries with new ones.

TV monitor output

Image is distorted or not showing on TV monitor.

Incorrect video system setting.

- Set the video system to the appropriate setting, NTSC or PAL, for your TV (p. 23).

Printing with a direct print compatible printer

Cannot print.

The camera and printer are not properly connected.

- Securely connect the camera and printer with the specified cable.

The printer power is not turned on.

- Turn on the printer power.

The print connection method is not correct.

- In the  (Set up) menu, select [Print Method] and select [Auto] (p. 23).

List of Messages

The following messages may appear on the LCD monitor during shooting or playback.

Please refer to the *Direct Print User Guide* for the messages that display during a printer connection.

Busy...

Image is being recorded to the memory card, or the playback mode is starting up.

No memory card

You turned on the camera without a memory card installed, or with a memory card installed in the wrong orientation (*Basic Guide* p. 5).

Card locked!

The SD memory card or SDHC memory card is write-protected.

Cannot record!

You attempted to shoot an image without a memory card installed, with a memory card installed in the wrong orientation, or attempted to attach a sound memo to a movie.

Memory card error

The memory card may be malfunctioning. By formatting the malfunctioning memory card with the camera, you may be able to continue using it. However, if this error message appears even when using the supplied memory card, contact your Canon Customer Support Help Desk as there may be a problem with the camera.

Memory card full

Memory card is full of images and no more can be recorded or saved. Or no more image settings or sound memos can be recorded.

Naming error!

The file name could not be created because there is an image with the same name as the folder that the camera is attempting to create, or the highest possible file number has already been reached. In the Set up menu, set **No.** (File Numbering) to [Auto Reset]; alternatively, save all the images you wish to retain onto a computer, then reformat the memory card. Please note that formatting will erase all the existing images and other data.

Change the batteries

Battery charge is insufficient to operate the camera. Replace both batteries immediately with unused AA-size alkaline batteries or fully charged Canon AA-size NiMH batteries. Also refer to *Battery Handling* (p. 91).

No image

No images recorded on memory card.

Image too large

You attempted to play back an image larger than 4992 × 3328 pixels or with a large data size.

Incompatible JPEG

You attempted to play back an incompatible JPEG image (an image that has been downloaded to a computer and altered., etc.).

RAW

You attempted to play back a RAW image.

Unidentified Image

You attempted to play back a corrupted image, an incompatible image (proprietary format used by another manufacturer's camera, etc.), an image edited on a computer or a movie clip recorded by another camera.

Cannot magnify!

You attempted to magnify an image recorded in a different camera or data type, an image edited with a computer, or a movie.

Cannot rotate

You attempted to rotate an image recorded in a different camera or data type, an image edited with a computer or a movie.

Incompatible WAVE

A sound memo cannot be added to this image since the data type of the existing sound memo is incorrect, or the sound memo cannot be played back.

Cannot transfer!

When transferring images to your computer using the Direct Transfer menu, you attempted to select an image with corrupted data, an image taken with a different camera or data type. You may have also attempted to select a movie when  (Wallpaper) was selected in the Direct Transfer menu.

Protected!

You attempted to erase or edit a protected image, movie or sound memo.

Too many marks

Too many images have been marked with print settings or transfer settings. Cannot process any more.

Cannot complete!

Could not save a part of the print, transfer or slide show settings.

Unselectable image

You attempted to set the print settings for a non-JPEG image.

Communication error

The computer was unable to download the image due to the large amount of images (approx. 1000) stored on the memory card.

Lens error, restart camera

An error was detected while the lens was in motion, and the power has been automatically turned off. This error can occur if you hold the lens while it is in motion or you operate it in a location with excessive dust or sand in the air. Try turning the power back on, and resume shooting or playback. If this message continues to display, contact your Canon Customer Support Help Desk as there may be a problem with the lens.

Exx

(xx: number) Camera detected an error. Turn the power off and then back on, then shoot or play back. A problem exists if the error code reappears. Note the number and contact your Canon Customer Support Help Desk. If an error code displays directly after taking a picture, the shot may not have been recorded. Check image in playback mode.

Battery Handling

Battery Charge

The following icon and message will display.



Battery charge is low. If using the camera for an extended period, replace the batteries as soon as possible.

Change the batteries

Batteries are depleted and the camera can no longer operate. Replace the batteries immediately.

Battery Handling Precautions

- **This camera uses AA-size alkaline batteries or Canon AA-size NiMH batteries (sold separately).**
While it is possible to use AA-size nickel-cadmium batteries, performance is unreliable and their use is not recommended.
- **Since the performance of alkaline batteries may differ according to brand, the operating time of the batteries you purchase may not be as long as the batteries that came with the camera.**
- **When using the camera under low temperature conditions or over long periods, you are recommend to use of Canon AA-size NiMH batteries (sold separately).**
Camera operating time may shorten at low temperatures when alkaline batteries are used. Also due to their specifications, alkaline batteries may expire faster than NiMH batteries.
- **Never mix unused and partially used batteries.**
The partially used batteries may leak.
- **Do not install the batteries with their terminals (+ and -) reversed.**
- **Do not mix batteries of different types or from different manufacturers.**

- **Before installing the batteries, wipe the battery terminals well with a dry cloth.**

If the battery terminals are soiled with oil from one's skin or other dirt, the number of recordable images may be considerably diminished, or the amount of time the camera can be used reduced.

- **At low temperatures, battery performance may be reduced and the low battery icon () may appear earlier than usual.**

Under these conditions, restore the battery performance by warming it in a pocket immediately before use.

- **Do not put the batteries into a pocket together with metallic items such as a key ring.**

The batteries may be short circuited.

- **When not using the camera for long periods, remove the batteries from the camera and store them separately.**

If the batteries are left inside the camera, the camera may become damaged from battery leakage.

WARNING

Never use damaged batteries or batteries whose outer seal is completely or partially missing or peeled off, as there is risk that such batteries may leak, overheat, or burst. Always check the seals on store-bought batteries before loading them, as some batteries may come with defective seals. Do not use batteries with defective seals.

Never use batteries that look like this.



Batteries with all or part of the seal (electrical insulation sheath) peeled off.



The positive electrode (plus terminal) is flat.



The negative terminal is correctly formed (protruding from the metal base), but the seal does not extend up over the edge of the metal base.

Handling the Memory Card

SD Memory Card or SDHC Memory Card Write Protect Tab

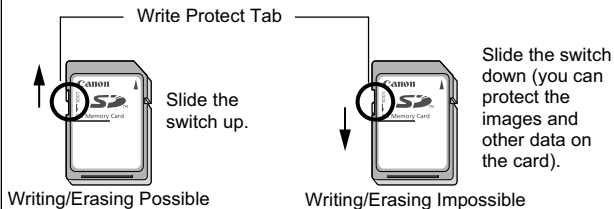

Cautions When Handling

- **Memory cards are high-precision electronic devices. Do not bend them, apply force to them, or subject them to shocks or vibration.**
- **Do not attempt to disassemble or alter the memory card.**
- **Do not allow dirt, water or foreign objects to contact the terminals on the back of the card. Do not touch the terminals with your hands or metal objects.**
- **Do not peel away the original label on the memory card or cover it with another label or sticker.**
- **When writing on the memory card, do not use a pencil or ball-point pen. Only use a soft point pen (e.g. felt-tip pen).**
- **Do not use or store memory cards in the following locations.**
 - Locations subject to dust or sand
 - Locations subject to high humidity and high temperatures
- **Since some or all of the data recorded on the memory card may be corrupted or erased by electrical noise, static electricity, camera or card malfunction, making a backup copy of important data is recommended.**

Formatting

- **Please note that formatting (initializing) an memory card erases all data, including protected images.**
- **You are recommended to use memory cards that have been formatted in your camera.**
 - The card supplied with the camera may be used without further formatting.
 - When the camera is malfunctioning, a corrupted memory card might be the cause. Reformatting the memory card may solve the problem.
 - When a non-Canon brand memory card is malfunctioning, reformatting it may solve the problem.
 - Memory cards formatted in other cameras, computers, or peripheral devices may not operate correctly in this camera. When that happens, reformat the memory card with this camera.
- **If formatting in the camera does not work properly, turn the camera off and re-insert the memory card. Then turn the camera back on and format again.**
- **Be careful when transferring or disposing of a memory card. Formatting or erasing the data on a memory card merely changes the file management information on the card and does not ensure that its contents are completely deleted.**

When disposing of a memory card, take precautions, such as physically destroying the card, to prevent personal information leaks.

Using the Power Kits (Sold Separately)

Using Rechargeable Batteries (Battery and Charger Kit CBK4-300)

This kit includes a battery charger and four rechargeable AA-size NiMH (nickel metal hydride) batteries. Charge batteries as shown below. Recharging is also possible using two batteries.

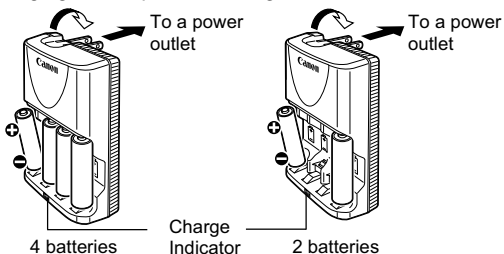

- After inserting the batteries, plug the charger (CB-5AH) into an outlet, or attach the power cord to the charger (CB-5AHE, not shown) and plug the other end into an outlet.
- Do not insert and charge additional batteries once charging has begun.
- The charge indicator blinks while charging, then remains lit when charging is finished.



- The CB-5AH/CB-5AHE battery charger can only be used to charge Canon AA-size NiMH Battery NB-3AH and NB-2AH. Please do not attempt to charge any other type of battery.
- Do not mix batteries with different purchase dates or different charge states. When recharging batteries, always recharge both of them at the same time.
- Do not attempt to recharge fully charged batteries, as doing so may reduce or impair battery performance. Also, do not charge batteries for more than 24 consecutive hours.
- Do not recharge batteries in enclosed areas that tend to retain heat.
- Do not recharge the batteries until the LCD monitor displays the "Change the batteries" message. Repeatedly recharging batteries before they are depleted may cause batteries to lose capacity.
- Wipe the battery terminals well with a dry cloth in the following situations, as the terminals may be soiled with oil from one's skin or other dirt:
 - If the battery usage time has considerably diminished
 - If the number of recordable images has considerably diminished
 - When charging the batteries (insert and remove the batteries two or three times before charging)
 - When charging completes in a space of a few minutes (the battery charger indicator remains lit)
- You may not be able to fully charge the batteries due to their specifications right after purchase or after long periods of nonuse. If this happens, after fully charging them, use the batteries until their charge is depleted. After doing this several times, battery performance will be restored.

- If you store batteries for a long period of time (about 1 year), it is recommended that you deplete the batteries in the camera and to then store them at room temperature (0 to 30 °C/32 to 90 °F) in low humidity. Storing them in a fully charged condition can shorten their lifespan or degrade their performance.

Again, if you do not use batteries for more than 1 year, fully charge them once a year and fully deplete in the camera before storing them.

- If the battery usage time has become considerably low despite wiping the terminals and charging them until the battery charger indicator remains lit, this may indicate that the batteries have reached the end of their lifespan. Replace them with new batteries. If you are purchasing new batteries, look for Canon AA-size NiMH batteries.
- Leaving batteries in the camera or charger may result in damage from battery leakage. When not in use, remove the batteries from the camera or charger and store them in a cool, dry location.



- It takes approximately 4 hours 40 minutes for the charger to fully recharge the batteries after they have been fully discharged. When two batteries are placed on each side of the charger, recharging will take approximately two hours (as determined by testing at Canon facilities). Charge batteries in an environment where the temperature is in the range of 0 to 35 °C (32 to 95 °F).
- The charging time varies according to the ambient temperature and to the battery charge state.
- The battery charger may emit noise while charging. This is not a malfunction.
- Battery and Charger Kit CBK4-200 can also be used.

Using the AC Adapter Kit ACK800

It is best to power the camera with AC Adapter Kit ACK800 (sold separately) when you are using it for long periods of time or connecting it to a computer.



Turn the camera power off before connecting or disconnecting the AC adapter.

1

Connect the power cord to the compact power adapter first and then plug the other end into the power outlet.

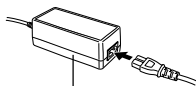

Compact Power Adapter CA-PS800

2

Open the terminal cover and attach the cord to the DC IN terminal.

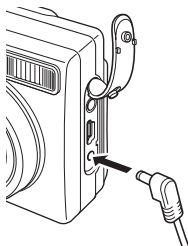

Using an Externally Mounted Flash (Sold Separately)

High-Power Flash HF-DC1

This flash is used to supplement the camera's built-in flash when the subject is too far away for proper illumination. Use the following procedures to affix the camera and High-Power Flash to the supporting bracket.

Please read the instructions accompanying the flash along with this explanation.

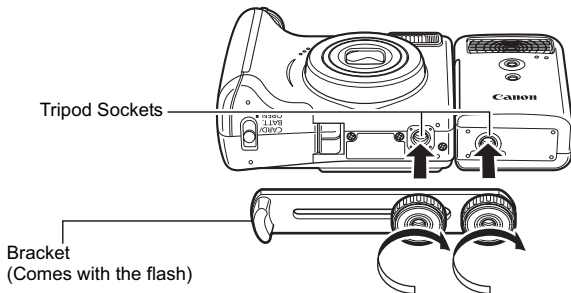



- The flash charge time will lengthen as the battery charge gets weaker. Always set the power/mode switch to [OFF] when you finish using the flash.
- Be careful not to touch the flash window or sensor windows with your fingers while the flash is in use.
- The flash may fire if another flash is being used in close proximity.
- The High-Power Flash may not fire outdoors in daylight or when there are no reflective items.
- For continuous shooting, although the flash fires for the first shot, it does not fire for subsequent shots.
- Fasten the attachment screws securely so that they do not loosen. Failure to do so may lead to the dropping of the camera and flash resulting in damage to both.



- Before attaching the bracket to the flash, check that the lithium battery (CR123A or DL123) is installed.
- To illuminate the subjects properly, install the flash so that it is up against the side of the camera and parallel with the camera's front panel.
- A tripod can be used even when the flash is attached.

■ Batteries

● Charge becomes Severely Limited

If the battery usage time has considerably diminished, wipe the battery terminals well with a dry cloth. The terminals may be dirty from fingerprints.

● Usage in Cold Temperatures

Get a spare generic lithium battery (CR123A or DL123). You are recommended to place the spare battery in your pocket to warm it up before switching it for the battery in the flash.

● Non-Use over Extended Periods

Leaving batteries in the High-Power Flash could allow the battery fluid to leak, damaging the product. Remove the batteries from the High-Power Flash and store them in a cool, dry place.

Replacing the Date Battery

If the LCD monitor displays the Date/Time menu when you turn on the camera, this means that the date battery has run down and the clock has stopped running. Please purchase a replacement battery (lithium coin battery CR1220) and install it as follows.

The date battery is preinstalled at the factory and may therefore expire earlier than its rated lifespan after the camera has been purchased.



Be particularly careful to keep the date batteries out of the reach of children. Seek medical assistance immediately if a child swallows a battery since corrosive battery fluids could damage the stomach or intestinal wall.

- 1 Confirm that the camera is turned off.**
- 2 Slide the memory card slot/battery cover lock and open the cover.**
- 3 Hook your nail onto the date battery holder (①) and lightly pull it up in the direction indicated by the arrow (②).**

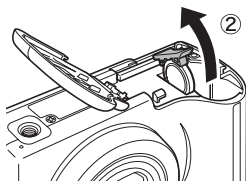

- 4 Remove the battery by pulling it up in the direction indicated by the arrow.**



- 5** Insert a new battery with the (-) side facing up.
- 6** Replace the battery holder and close the memory card slot/battery cover.
- 7** When the Date/Time menu appears, set the date and time (*Basic Guide* p. 8).



After purchasing the camera and turning on the power for the first time, although the Date/Time menu will appear, you do not need to replace the date battery.

If you ever dispose of your camera, first remove the date battery for recycling according to the recycling system of your country.

Camera Care and Maintenance

Never use thinners, benzine, detergents or water to clean the camera. These substances may distort or damage the equipment.

Camera Body

Gently wipe dirt off the camera body with a soft cloth or eyeglass lens wiper.

Lens

First use a lens blower brush to remove dust and dirt, then remove any remaining dirt by wiping the lens lightly with a soft cloth.



Never use organic solvents on the camera body or lens. If dirt remains, contact the closest Canon Customer Support Help Desk as listed on the separate customer support list supplied with your camera.

Viewfinder and LCD Monitor

Use a lens blower brush to remove dust and dirt. If necessary, gently wipe with a soft cloth or an eyeglass lens wiper to remove stubborn dirt.



Never rub or press strongly on the LCD monitor. These actions may damage it or lead to other problems.

Specifications

All data is based on Canon's standard testing methods. Subject to change without notice.

PowerShot A550

Camera Effective Pixels	: Approx. 7.1 million
Image Sensor	: 1/2.5-inch type CCD (Total number of pixels: Approx. 7.4 million)
Lens	: 5.8 (W) – 23.2 (T) mm (35mm film equivalent: 35 (W) – 140 (T) mm) f/2.6 (W) – f/5.5 (T)
Digital Zoom	: Still images/Movies: Approx. 4.0x (Up to approx. 16x in combination with the optical zoom)
Optical Viewfinder	: Real-image zoom viewfinder
LCD Monitor	: 2.0-inch, low-temperature polycrystalline silicon TFT color LCD, approx. 86,000 pixels (Picture coverage 100%)
AF System	: TTL autofocus AF lock available Focusing frame: 9-point (AiAF) / 1-point (AF) (1-point focusing frame: fixed to center)
Focusing Range	: Normal: 45 cm (1.5 ft.) – infinity Macro: 5 – 45 cm (W)/33 – 45 cm (T) (2.0 in. – 1.5 ft. (W)/1.1 – 1.5 ft. (T))
Shutter	: Mechanical shutter + electronic shutter
Shutter Speeds	: 15 – 1/2000 sec. <ul style="list-style-type: none">• The shutter speed varies according to the shooting mode.• Slow shutter speeds of 1.3 sec. or slower operate with noise reduction.
Metering System	: Evaluative, Center-weighted average or Spot* (*Fixed to center)

(W): Max. wide angle (T): Max. telephoto

Exposure Compensation	: ± 2.0 stops in 1/3-stop increments
ISO Speed (Standard Output Sensitivity, Recommended Exposure Index)	: Auto*, High ISO Auto**, ISO 80/100/200/400/800 * Camera automatically sets the optimal speed according to subject brightness. ** Camera automatically sets the optimal speed according to subject brightness. However, the ISO speed is set relatively higher than Auto (maximum ISO speed is ISO 800.)
White Balance	: Auto, Day Light, Cloudy, Tungsten, Fluorescent, Fluorescent H or Custom
Built-in Flash	: Auto*, on*, off * Red-eye reduction and Slow Synchro are available.
Flash Range	: Normal: 45 cm – 3.5 m (1.5 – 11 ft.) (W)/ 45 cm – 2.2 m (1.5 – 7.2 ft.) (T) Macro: 30 – 45 cm (12 in. – 1.5 ft.) (W)/ 33 – 45 cm (1.1 – 1.5 ft.) (T) (When ISO speed is set to AUTO.)
Shooting Modes (Still images)	: Auto, Manual*, Portrait, Landscape, Night Snapshot, Kids&Pets, Indoor and Special Scene** * Long Shutter mode available. ** Night Scene, Foliage, Snow, Beach and Fireworks (Movies) : Standard, Fast Frame Rate and Compact
Continuous Shooting	: Approx. 1.7 shots/sec. (Large/Fine mode)
Self-timer	: Activates shutter after an approx. 10-sec./approx. 2-sec. delay, Custom Timer
Recording Media	: SD memory card or SDHC memory card/ MultiMediaCard
File Format	: Design rule for camera file system and DPOF compliant (W): Max. wide angle (T): Max. telephoto

Data Type (Still images) : Exif 2.2 (JPEG)*

Sound Memo: WAVE (monaural)

* This digital camera supports Exif 2.2 (also called "Exif Print"). Exif Print is a standard for enhancing the communication between digital cameras and printers. By connecting to an Exif Print-compliant printer, the camera's image data at the time of shooting is used and optimized, yielding extremely high quality prints.

(Movies) : AVI (Image data: Motion JPEG;

Audio data: WAVE (monaural))

Compression : Superfine, Fine, Normal

Number of (Still images) :	Large	:	3072 × 2304 pixels
Recording	Medium 1	:	2592 × 1944 pixels
Pixels	Medium 2	:	2048 × 1536 pixels
	Medium 3	:	1600 × 1200 pixels
	Small	:	640 × 480 pixels
	Postcard	:	1600 × 1200 pixels
	Widescreen	:	3072 × 1728 pixels

(Movies) : Standard

: 640 × 480 pixels (30 frames/sec., 15 frames/sec.)

: 320 × 240 pixels (30 frames/sec., 15 frames/sec.)

Recording can continue until the memory card is full*

(Max. Clip Size at one time: 1 GB**)

Fast Frame Rate: 320 × 240 pixels (60 frames/sec.)

Max. Clip Length: 1 minutes

Compact: 160 × 120 pixels (15 frames/sec.)

Max. Clip Length: 3 minutes

* Using super high-speed memory cards (SDC-512 MSH recommended).

** Even if the clip size has not reached 1GB, recording will stop at the moment the clip length reaches 1 hour. Depending on the volume and data writing speed of the memory card, recording will stop after one hour of continuous recording even if the recorded data volume has not reached 1GB.

Playback Modes	: Single (histogram displayable), Index (9 thumbnail images), Magnified (approx. 10x (max.) in LCD monitor, advance or reverse through magnified images possible), Jump (it is possible to jump to every tenth or hundredth image, to the first image of each shooting date, to the first image in each folder, or to movies. In index playback mode, it displays 9 images at once.), Auto Play, Sound memos (up to 1 min.) or Movie (slow motion play back possible).
Direct Print	: PictBridge compliant, and Canon Direct Print and Bubble Jet Direct compatible
Interface	: USB 2.0 Hi-Speed (mini-B) Audio/Video output (NTSC or PAL selectable, monaural audio)
Communication Settings	: MTP, PTP
Power Source	: AA alkaline batteries (included in the camera kit) AA NiMH batteries (NB4-300) (sold separately) AC Adapter Kit ACK800 (sold separately)
Operating Temperatures	: 0 – 40 °C (32 – 104 °F) (when a NB4-300 is used, 0 – 35 °C (32 – 95 °F))
Operating Humidity	: 10 – 90%
Dimensions (excluding protrusions)	: 91.2 × 64.0 × 43.1 mm (3.59 × 2.52 × 1.70 in.)
Weight (camera body only)	: Approx. 160 g (5.64 oz.)

Battery Capacity

	Number of Images Shot		Playback Time
	LCD Monitor On (Based on the CIPA standard)	LCD Monitor Off	
AA-size Alkaline Batteries (included with the camera)	Approx. 140 images	Approx. 1000 images	Approx. 9 hours
AA-size NiMH Batteries (NB-3AH (fully charged))	Approx. 550 images	Approx. 1400 images	Approx. 11 hours

- The actual figures will vary according to the shooting conditions and settings.
- Movie data is excluded.
- At low temperatures, the battery performance may diminish and the low battery icon may appear very rapidly. In these circumstances, the performance can be improved by warming the battery in a pocket before use.

Test Conditions

Shooting: Normal temperature (23 °C ±2 °C/73 °F ±3.6 °F), normal relative humidity (50% ±20%), alternating wide angle end and telephoto end shots at 30 second intervals with the flash fired once every two shots and the camera power turned off after every tenth shot. Power is left off for a sufficient amount of time*, then the power is turned back on and the testing procedure is repeated.

- A Canon-brand memory card is used.

* Until the battery returns to normal temperature





















Playback: Normal temperature (23 °C ±2 °C/73 °F ±3.6 °F), normal relative humidity (50% ±20%), continuous playback at 3 seconds per image.



See *Battery Handling Precautions* (p. 91).

Memory Cards and Estimated Capacities













: Card included with the camera

Recording Pixels	Compression	16MB	SDC-128M	SDC-512MSH
L (Large) 3072 × 2304 pixels		4	40	156
		7	64	251
		16	134	520
M1 (Medium 1) 2592 × 1944 pixels		5	49	190
		10	87	339
		21	173	671
M2 (Medium 2) 2048 × 1536 pixels		9	76	295
		16	136	529
		33	269	1041
M3 (Medium 3) 1600 × 1200 pixels		14	121	471
		26	217	839
		50	411	1590
S (Small) 640 × 480 pixels		56	460	1777
		88	711	2747
		138	1118	4317
 (Postcard) 1600 × 1200 pixels		26	217	839
W (Widescreen) 3072 × 1728 pixels		6	53	207
		10	86	335
		21	177	686

-  Capable of smooth continuous shooting (p. 31) (When card has been formatted with a low level format).
- This reflects standard shooting criteria established by Canon. Actual results may vary according to the subject and shooting conditions.

Movie

: Card included with the camera

	Recording Pixels	Frame Rate	16MB	SDC-128M	SDC-512MSH
 Standard	 640 × 480 pixels		7 sec.	1 min. 4 sec.	4 min. 9 sec.
			15 sec.	2 min. 7 sec.	8 min. 14 sec.
	 320 × 240 pixels		22 sec.	3 min. 1 sec.	11 min. 42 sec.
			43 sec.	5 min. 55 sec.	22 min. 53 sec.
 Fast Frame Rate	 320 × 240 pixels		11 sec.	1 min. 32 sec.	5 min. 59 sec.
 Compact	 160 × 120 pixels		1 min. 47 sec.	14 min. 29 sec.	55 min. 57 sec.

























* Maximum clip length at : 1 min and : 3 min. The figures indicate the maximum continuous recording time.

Image Data Sizes (Estimated)

Recording Pixels		Compression		
				
 L	3072 × 2304 pixels	3045 KB	1897 KB	902 KB
 M1	2592 × 1944 pixels	2503 KB	1395 KB	695 KB
 M2	2048 × 1536 pixels	1602 KB	893 KB	445 KB
 M3	1600 × 1200 pixels	1002 KB	558 KB	278 KB
 S	640 × 480 pixels	249 KB	150 KB	84 KB
 W	1600 × 1200 pixels	—	558 KB	—
 W	3072 × 1728 pixels	2304 KB	1420 KB	678 KB

	Recording Pixels	Frame Rate	File size
 Standard	 640 × 480 pixels		1920 KB/sec.
			960 KB/sec.
	 320 × 240 pixels		660 KB/sec.
			330 KB/sec.
 Fast Frame Rate	 320 × 240 pixels		1320 KB/sec.
 Compact	 160 × 120 pixels		120 KB/sec.

MultiMediaCard

Interface	Compatible with MultiMediaCard standards
Dimensions	32.0 × 24.0 × 1.4 mm (1.3 × 0.9 × 0.06 in.)
Weight	Approx. 1.5 g (0.05 oz.)

SD Memory Card

Interface	Compatible with SD memory card standards
Dimensions	32.0 × 24.0 × 2.1 mm (1.3 × 0.9 × 0.1 in.)
Weight	Approx. 2 g (0.07 oz.)

NiMH Battery NB-3AH

(Supplied with the separately sold NiMH Battery NB4-300 set or the Battery and Charger Kit CBK4-300)

Type	AA-size rechargeable nickel metal hydride battery
Nominal Voltage	1.2 V DC
Typical Capacity	2500 mAh (min.: 2300 mAh)
Cycle Life	Approx. 300 times
Operating Temperatures	0 – 35 °C (32 – 95 °F)
Diameter × Length	14.5 × 50.0 mm (0.57 × 2.0 in.)
Weight	Approx. 30 g (1.06 oz.)

Battery Charger CB-5AH/CB-5AHE

(Supplied with the separately sold Battery and Charger Kit CBK4-300)

Rated Input	100 – 240 V AC (50/60 Hz)
Rated Output	565 mA ^{*1} , 1275 mA ^{*2}
Charging Time	Approx. 4 hours 40 min. ^{*1} , approx. 2 hours ^{*2}
Operating Temperatures	0 – 35 °C (32 – 95 °F)
Dimensions	65.0 × 105.0 × 27.5 mm (2.56 × 4.13 × 1.08 in.)
Weight (body only)	95 g (3.35 oz.)

*1 When charging four NB-3AH batteries

*2 When charging two NB-3AH batteries loaded one on each side of the battery charger

Compact Power Adapter CA-PS800

(Included with the separately sold AC Adapter Kit ACK800)

Rated Input	100 – 240 V AC (50/60 Hz)
Rated Output	3.15 V DC, 2.0 A
Operating Temperatures	0 – 40 °C (32 – 104 °F)
Dimensions	42.6 × 104.0 × 31.4 mm (1.68 × 4.09 × 1.24 in.)
Weight	Approx. 180 g (6.35 oz.) (excluding power cord)

INDEX

Numerics

3:2 Guide 13, 34

A

AC Adapter Kit ACK800 98
AE Lock 42
AF Frame 13, 39
AF Lock 41
AF-assist Beam 21, 80
AiAF 39
Auto Play 65
Auto Power Down 23
Auto Rotate 53

B

Battery
 Battery Capacity 108
 Capacity 91
 Charging 91
 Handling 91
 Installing *Basic* 5
Beach *Basic* 12

C

Camera Care and Maintenance
..... 103
Compact Power Adapter
..... 98, 112
Compression 27
Continuous Shooting 31
Create Folder 54

D

Date Stamp 21, 33
DCF 15, 105

Default Values 24
Detailed Display 15
Digital Tele-Converter 28
DIGITAL Terminal *Basic* 27
Digital Zoom 28
Direct Transfer *Basic* 30
Display Overlays 34
Downloading Images to a
Computer *Basic* 24
DPOF
 Selecting Images 69
 Transfer Order 74

E

Erasing
 All Images 68
 Single Image *Basic* 19
Exposure 42, 44

F

FE Lock 43
File No. 72
File Number 14
File Numbering 56
Fireworks *Basic* 12
Flash *Basic* 14
Focus *Basic* 10
Focus Lock 40
Foliage *Basic* 12
Formatting 25
Frame Rate 38
FUNC. Menu 20
FUNC./SET 18, *Basic* 3
Functions Available 119

G
Grid Lines 13, 34

H
HF-DC1 99
High-Power Flash 99
Histogram 16

I
Image Data Sizes (Estimated)
..... 110
Image zone *Basic* 11
Index Playback 59
Indicators *Basic* 3, 4
Indoor *Basic* 12
Interface Cable *Basic* 22, 27
ISO Speed 52

J
Jump (Image Search) 60

K
Kids&Pets *Basic* 11

L
Landscape *Basic* 11
Language 23
LCD Monitor
 Night Display 12
 Playback Information 14
 Shooting Information 13
Long Shutter Mode 45

M
Macro *Basic* 16
Magnifying 58

MANUAL
 Shooting Mode *Basic* 13
Memory Card
 Estimated Capacities 109
 Formatting 25
 Handling 93
Memory card
 Inserting *Basic* 5
MENU 19, *Basic* 3
Menu
 FUNC. Menu 18, 20
 Menus and Settings 18, 19
 Play Menu 19, 21
 Print Menu 19, 21
 Rec. Menu 19, 21
 Set up Menu 19, 22
Message 87
Metering Mode 43
Microphone *Basic* 1
Mode Button *Basic* 3
Movie
 Shooting 35
Mute 22
My Colors 49

N
Night Display 12
Night Scene *Basic* 12
Night Snapshot *Basic* 11

O
Operation Vol. 22

P
Play Menu 21
Playback *Basic* 19
Playback Information 14
Playback Mode *Basic* 19
Playback Vol. 22

Portrait	<i>Basic</i> 11
Power Button	<i>Basic</i> 3, 9
Power Saving Function	17
Print Menu	21
Print/Share Button	<i>Basic</i> 3, 22
Printing	69, <i>Basic</i> 22
Protect	66

R

Rec. Menu	21
Rechargeable Batteries	95
Rechargeable Battery	112
Recording Pixels	13, 26, 38
Red-Eye Reduction	<i>Basic</i> 15
Reset All	24
Review	21, <i>Basic</i> 10
Using a TV	67
Rotate	63

S

Safety Zoom	29
Selftimer Vol.	22
Set up Menu	22
Setting the Date/Time	<i>Basic</i> 8
Setting the Language	<i>Basic</i> 8
Shooting Information	13
Shooting Mode	<i>Basic</i> 11
Functions Available	119
Image Zone	<i>Basic</i> 11
Shutter Button	
Fully	<i>Basic</i> 10
Halfway	<i>Basic</i> 10
Shutter Volume	22
Single Playback	<i>Basic</i> 19
Slow Synchro	<i>Basic</i> 15
Smooth Continuous Shooting	
.....	31
Snow	<i>Basic</i> 12
Sound Memo	64

Special Scene mode	<i>Basic</i> 12
Spot AE Point	44
Spot AE Point Frame	13
Standard Display	14
Start-up Vol.	22
System Requirements ..	<i>Basic</i> 25

T

Telephoto	<i>Basic</i> 14
-----------------	-----------------

U

Using the LCD Monitor	12
-----------------------------	----

V

Video System	23
Viewing	
Movie	61
Volume	22

W

White Balance	47
Wide Angle	<i>Basic</i> 14

Z

Zoom	28, <i>Basic</i> 14
------------	---------------------

MEMO

FCC Notice

(Digital Camera, Model PC1230)

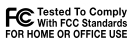

This device complies with Part 15 of the FCC Rules. Operation is subject to the following two conditions;

- (1) this device may not cause harmful interference, and
- (2) this device must accept any interference received, including interference that may cause undesired operation.

Note: This equipment has been tested and found to comply with the limits for Class B digital devices, pursuant to Part 15 of the FCC rules. These limits are designed to provide reasonable protection against harmful interference in a residential installation. This equipment generates, uses and can radiate radio frequency energy and, if not installed and used in accordance with the instructions, may cause harmful interference to radio communications. However, there is no guarantee that interference will not occur in a particular installation. If this equipment does cause harmful interference to radio or television reception, which can be determined by turning the equipment off and on, the user is encouraged to try to correct the interference by one or more of the following measures:

- Reorient or relocate the receiving antenna.
- Increase the separation between the equipment and receiver.
- Connect the equipment into an outlet on a circuit different from that to which the receiver is connected.
- Consult the dealer or an experienced radio/TV technician for help.

The cable with the ferrite core provided with the digital camera must be used with this equipment in order to comply with Class B limits in Subpart B of Part 15 of the FCC rules.

Do not make any changes or modifications to the equipment unless otherwise specified in the manual. If such changes or modifications should be made, you could be required to stop operation of the equipment.

Canon U.S.A., Inc.

One Canon Plaza, Lake Success, NY 11042, U.S.A.

Tel No. (516) 328-5600

Canadian Radio Interference Regulations

This Class B digital apparatus complies with Canadian ICES-003.

Réglementation canadienne sur les interférences radio

Cet appareil numérique de la classe B est conforme à la norme NMB-003 du Canada.

Disclaimer

- While every effort has been made to ensure that the information contained in this guide is accurate and complete, no liability can be accepted for any errors or omissions.
- Canon reserves the right to change the specifications of the hardware and software described herein at anytime without prior notice.
- No part of this guide may be reproduced, transmitted, transcribed, stored in a retrieval system, or translated into any language in any form, by any means, without the prior written permission of Canon.
- Canon makes no warranties for damages resulting from corrupted or lost data due to a mistaken operation or malfunction of the camera, the software, SD memory cards (SD cards), personal computers, peripheral devices, or use of non-Canon SD cards.

Trademark Acknowledgments

- Windows, Windows Vista and the Windows Vista logo are trademarks of Microsoft Corporation, registered in the U.S. and other countries.
- Macintosh, Mac logo and QuickTime are trademarks of Apple Computer, Inc., registered in the U.S. and other countries.
- The SDHC logo is a trademark.

For CA, USA only

Included lithium battery contains Perchlorate Material - special handling may apply.

See www.dtsc.ca.gov/hazardouswaste/perchlorate/ for details.

Copyright © 2007 Canon Inc. All rights reserved.

Functions Available in Each Shooting Mode

The following chart shows the functions and settings available in each shooting mode.

























Functions		AUTO		SCN			Ref. Page
Recording Pixels (Still Image)	Large L	●	●	●	—	●	p. 26
	Medium 1 M1	○	○	○	—	○	
	Medium 2 M2	○	○	○	—	○	
	Medium 3 M3	○	○	○	—	○	
	Small S	○	○	○	—	○	
	Postcard	○	○	○	—	○	
	Widescreen W	○	○	○	—	○	
Compression (Movie)		—	—	—	○ ⁽¹⁾	—	p. 38
Compression	Super Fine S	○	○	○	—	○	p. 27
	Fine	●	●	●	—	●	
	Normal	○	○	○	—	○	
Frame Rate (Movie)		—	—	—	○ ⁽¹⁾	—	p. 38
Flash ⁽³⁾	Auto	○	○	○	—	○ ⁽²⁾	Basic Guide p. 14
	On	—	○	○	—	○	
	Off	○	○	○	—	○	
Red-Eye Reduction		●	●	● ⁽⁴⁾	—	●	Basic Guide p. 15
Slow Synchro		—	— ⁽⁵⁾	— ⁽⁶⁾	—	○ ⁽²⁾	Basic Guide p. 15
Macro Mode		○	○ ⁽⁷⁾	○ ⁽⁴⁾	○	○	Basic Guide p. 16

Functions		AUTO		SCN			Ref. Page
Drive Mode	Single	●	●	●	●	●	–
	Continuous	–	○	○	–	○	p. 31
	10-sec. self-timer	○	○	○	○	○	Basic Guide p. 17
	2-sec. self-timer	○	○	○	○	○	
	Custom Timer	○	○	○	–	○	
Date Stamp		○	○	○	–	○	p. 33
AiAF		○	○	○ ⁽⁴⁾	–	○	p. 39
AF Lock		–	–	–	○	○	p. 41
AF-assist Beam		●	●	● ⁽⁴⁾	●	●	p. 21
Digital Zoom		●	●	●	● ⁽⁸⁾	●	p. 28
Digital Tele-Converter		○	○	○	–	○	p. 28
Exposure Compensation		–	○	○	–	○ ⁽²⁾	p. 44
ISO Speed		○ ⁽⁹⁾	– ⁽¹⁰⁾	– ⁽¹⁰⁾	– ⁽¹⁰⁾	○ ⁽¹¹⁾	p. 52
White Balance ⁽¹²⁾		– ⁽¹⁰⁾	– ⁽¹⁰⁾	– ⁽¹⁰⁾	○	○	p. 47
Long Shutter		–	–	–	–	○	p. 45
Metering Method	Evaluative	●	●	●	●	●	p. 43
	Center Weighted Avg.	–	–	–	–	○ ⁽²⁾	
	Spot	–	–	–	–	○ ⁽²⁾	
AE Lock		–	–	–	–	○ ⁽²⁾	p. 42
FE Lock		–	–	–	–	○ ⁽²⁾	p. 43
My Colors		–	–	–	○	○	p. 49
Disp. Overlay		○	○	○	○ ⁽¹³⁾	○	p. 34
Auto Rotate		●	●	●	–	●	p. 53

* ○ : Setting available (● : Default settings.) – : Setting selection is not possible.

• (Shaded Area): Setting is retained even when the camera power is shut off.

• With the exception of the [Date/Time], [Language] and [Video System] settings, all the other menu settings and changes made with the camera buttons can be reset to the default values in a single operation (p. 24).

- (1) The recording pixels and frame rates for the  (Movie) mode (p. 38).
- (2) This cannot be set in Long Shutter mode.
- (3) Auto is the default setting in , , , ,  and **SCN** (  ) modes. Off is the default setting in , **SCN** ( ) and  modes.
 - You cannot use flash in  mode.
- (4) This cannot be set in  mode.
- (5) Slow Synchro will be fixed to [On] in the  or  modes. [Off] cannot be selected.
- (6) Slow Synchro will be fixed to [On] in the  mode. [Off] cannot be selected.
- (7) This cannot be set in  or  mode.
- (8) Can only be set and used in the  mode.
- (9) Only switching between  and  is available.
- (10) Automatically set by the camera.
- (11)  or  cannot be set in Long Shutter mode.
- (12) This cannot be set when My Colors is set to [Sepia] or [B/W].
- (13) Only Grid Lines can be set.

Free Manuals Download Website

<http://myh66.com>

<http://usermanuals.us>

<http://www.somanuals.com>

<http://www.4manuals.cc>

<http://www.manual-lib.com>

<http://www.404manual.com>

<http://www.luxmanual.com>

<http://aubethermostatmanual.com>

Golf course search by state

<http://golfingnear.com>

Email search by domain

<http://emailbydomain.com>

Auto manuals search

<http://auto.somanuals.com>

TV manuals search

<http://tv.somanuals.com>