

PowerShot SX730 HS Camera User Guide

ENGLISH

- Make sure you read this guide, including the “Safety Instructions” (📖 14) section, before using the camera.
- Reading this guide will help you learn to use the camera properly.
- Store this guide safely so that you can use it in the future.

- Click the buttons in the lower right to access other pages.

 : Next page

 : Previous page

 : Page before you clicked a link

- To jump to the beginning of a chapter, click the chapter title at right.

Before Use

Basic Guide

Advanced Guide

Camera Basics

Auto Mode /
Hybrid Auto Mode

Other Shooting Modes

P Mode

Tv, Av, and M Mode

Playback Mode

Wireless Features

Setting Menu

Accessories

Appendix

Index

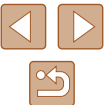

Before Use

Initial Information

Package Contents

Before use, make sure the following items are included in the package. If anything is missing, contact your camera retailer.

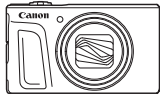

Camera



Battery Pack
NB-13L*



Battery Charger
CB-2LH/CB-2LHE



Wrist Strap

* Do not peel off the adhesive covering from a battery pack.

- Printed matter is also included.
- A memory card is not included (📖2).

Compatible Memory Cards

The following memory cards (sold separately) can be used, regardless of capacity.

- SD memory cards*¹
- SDHC memory cards *^{1*2}
- SDXC memory cards*^{1*2}



*1 Cards conforming to SD standards. However, not all memory cards have been verified to work with the camera.

*2 UHS-I memory cards are also supported.

Before Use

Basic Guide

Advanced Guide

Camera Basics

Auto Mode /
Hybrid Auto Mode

Other Shooting Modes

P Mode

Tv, Av, and M Mode

Playback Mode

Wireless Features

Setting Menu

Accessories

Appendix

Index

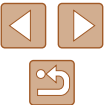

Preliminary Notes and Legal Information

- Take and review some test shots initially to make sure the images were recorded correctly. Please note that Canon Inc., its subsidiaries and affiliates, and its distributors are not liable for any consequential damages arising from any malfunction of a camera or accessory, including memory cards, that result in the failure of an image to be recorded or to be recorded in a way that is machine readable.
- The user's unauthorized photographing or recording (video and/or sound) of people or copyrighted materials may invade the privacy of such people and/or may violate others' legal rights, including copyright and other intellectual property rights, even when such photographing or recording is intended solely for personal use.
- The camera warranty is valid only in the area of purchase. In case of camera problems while abroad, return to the area of purchase before contacting a Canon Customer Support Help Desk.
- Although the screen (monitor) is produced under extremely high-precision manufacturing conditions and more than 99.99% of the pixels meet design specifications, in rare cases some pixels may be defective or may appear as red or black dots. This does not indicate camera damage or affect recorded images.
- When the camera is used over an extended period, it may become warm. This does not indicate damage.

Conventions in This Guide

- In this guide, icons are used to represent the corresponding camera buttons and dials on which they appear or which they resemble.
- The following camera buttons and controls are represented by icons. Numbers in parentheses indicate the numbers of corresponding controls in "Part Names" (📖4).
 - [▲] Up button (12) on back
 - [◀] Left button (8) on back
 - [▶] Right button (13) on back
 - [▼] Down button (15) on back
 - [🔘] Control dial (7) on back
- Shooting modes and on-screen icons and text are indicated in brackets.
- ⓘ: Important information you should know
- 📌: Notes and tips for expert camera use
- 📖xx: Pages with related information (in this example, "xx" represents a page number)
- Instructions in this guide apply to the camera under default settings.
- For convenience, all supported memory cards are simply referred to as the "memory card".
- The symbols "▶ Still Images" and "▶ Movies" below titles indicate how the function is used—whether for still images or movies.

Before Use

Basic Guide

Advanced Guide

Camera Basics

Auto Mode /
Hybrid Auto Mode

Other Shooting Modes

P Mode

Tv, Av, and M Mode

Playback Mode

Wireless Features

Setting Menu

Accessories

Appendix

Index

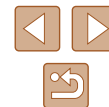

Part Names

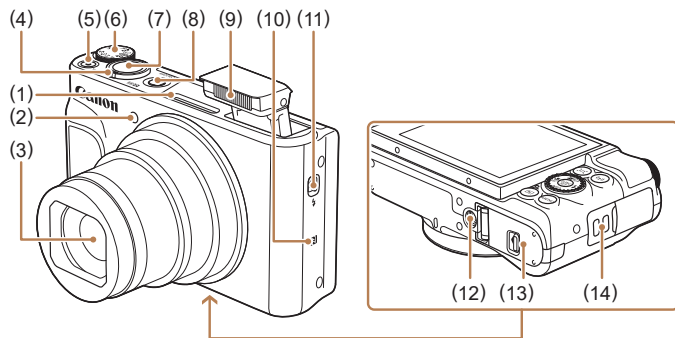

- | | |
|--|--------------------------------|
| (1) Microphone | (6) Mode dial |
| (2) Lamp | (7) Shutter button |
| (3) Lens | (8) Power button |
| (4) Zoom lever | (9) Flash |
| Shooting: [T] (telephoto) / [W] (wide angle) | (10) [N] (N-Mark)* |
| Playback: [Q] (magnify) / [I] (index) | (11) [Flash pop up] switch |
| (5) Movie button | (12) Tripod socket |
| | (13) Memory card/battery cover |
| | (14) Strap mount |

* Used with NFC features (115).

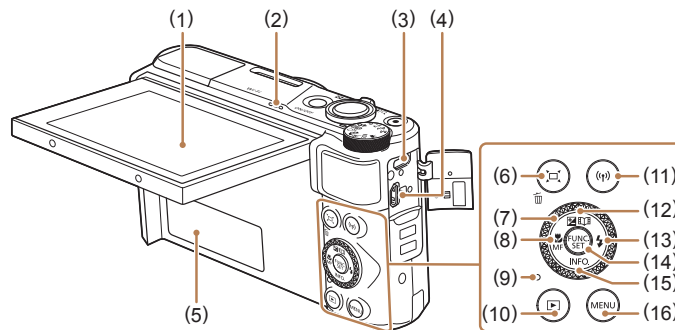

- | | |
|---|---|
| (1) Screen (monitor) | (9) Indicator |
| (2) Speaker | (10) [Play] (Playback) button |
| (3) DIGITAL terminal | (11) [Wi-Fi] (Wi-Fi) button |
| (4) HDMI™ terminal | (12) [Exposure compensation] / [Story Highlights] / Up button |
| (5) Serial number (Body number) | (13) [Flash] / Right button |
| (6) [Framing Assist – Seek] / [Single-image erase] button | (14) FUNC. (Function) / SET button |
| (7) Control dial | (15) [INFO.] (Information) / Down button |
| (8) [Macro] / [MF (Manual focus)] / Left button | (16) [MENU] button |



- You can turn the control dial to perform most of the operations possible with the [▲][▼][◀][▶] buttons, such as choosing items and switching images.

- Before Use
- Basic Guide
- Advanced Guide
 - Camera Basics
 - Auto Mode / Hybrid Auto Mode
 - Other Shooting Modes
 - P Mode
 - Tv, Av, and M Mode
 - Playback Mode
 - Wireless Features
 - Setting Menu
 - Accessories
 - Appendix
- Index



Table of Contents

Before Use

Initial Information	2
Package Contents	2
Compatible Memory Cards.....	2
Preliminary Notes and Legal Information	3
Conventions in This Guide	3
Part Names	4
Common Camera Operations	12
Safety Instructions.....	14

Basic Guide

Basic Operations	17
Initial Preparations.....	17
Attaching the Strap	17
Holding the Camera.....	17
Charging the Battery Pack.....	18
Inserting the Battery Pack and Your Memory Card	18
Removing the Battery Pack and Memory Card	19
Setting the Date and Time	19
Changing the Date and Time.....	20
Display Language.....	21
Trying the Camera Out.....	21
Shooting (Smart Auto).....	21
Viewing.....	23
Erasing Images	24

Advanced Guide

Camera Basics	25
On/Off.....	25
Power-Saving Features (Auto Power Down).....	26
Power Saving in Shooting Mode	26
Power Saving in Playback Mode.....	26
Shutter Button	26
Shooting Modes	27
Shooting Display Options	27
Adjusting the Screen Angle	28
Using the FUNC. Menu	28
Using the Menu Screen.....	29
On-Screen Keyboard.....	30
Indicator Display.....	31
Clock	32
Auto Mode / Hybrid Auto Mode	33
Shooting with Camera-Determined Settings	33
Shooting (Smart Auto)	33
Shooting in Hybrid Auto Mode	35
Digest Movie Playback	36
Still Images/Movies	36
Still Images.....	36
Movies	36
Scene Icons.....	37
Continuous Shooting Scenes	38
Image Stabilization Icons.....	38
On-Screen Frames.....	39
Common, Convenient Features	39
Zooming In Closer on Subjects (Digital Zoom).....	39

Before Use
Basic Guide
Advanced Guide
Camera Basics
Auto Mode / Hybrid Auto Mode
Other Shooting Modes
P Mode
Tv, Av, and M Mode
Playback Mode
Wireless Features
Setting Menu
Accessories
Appendix
Index



Easily Reacquiring Subjects after Manual Zooming (Framing Assist – Seek)	40
Auto Zooming in Response to Subject Movement (Auto Zoom).....	40
Adjusting the Constant Face Display Size	41
Easily Reacquiring Subjects with Auto Zooming (Seek Assist).....	42
Adding a Date Stamp	42
Using the Self-Timer.....	43
Using the Self-Timer to Avoid Camera Shake	44
Customizing the Self-Timer	44
Continuous Shooting	44
Image Display during Playback	45
Using Face ID.....	45
Personal Information	45
Registering Face ID Information.....	46
Shooting	47
Checking and Editing Registered Information	47
Overwriting and Adding Face Information	48
Erasing Registered Information	49
Image Customization Features	50
Changing the Aspect Ratio	50
Changing the Number of Recording Pixels (Image Size).....	50
Guidelines for Choosing Recording Pixel Setting	
Based on Paper Size (for 4:3 Images)	50
Correcting Greenish Image Areas from Mercury Lamps	51
Changing Movie Image Quality	51
Helpful Shooting Features.....	52
Displaying Grid Lines.....	52
Deactivating Auto Level.....	52
Changing the IS Mode Settings.....	53
Deactivating Image Stabilization	53

Recording Movies with Subjects at the Same Size Shown before Shooting.....	53
Customizing Camera Operation	54
Preventing the AF-Assist Beam from Firing.....	54
Preventing the Red-Eye Reduction Lamp from Lighting Up.....	54
Changing the Image Display Style after Shots	55
Changing the Image Display Period after Shots	55
Changing the Screen Displayed after Shots	55

Other Shooting Modes..... 56

Applying Effects Automatically (Creative Shot)	56
Enjoying a Variety of Images from Each Shot	56
Choosing Effects	57
Recording Movies with a Variety of Effects.....	57
Creative Shot Movie Playback	57
Shooting Yourself under Optimal Settings (Self Portrait).....	58
Moving Subjects (Sports)	59
Specific Scenes.....	59
Applying Special Effects.....	60
Shooting with a Skin Smoothing Effect (Smooth Skin).....	61
Shooting with a Fish-Eye Lens Effect (Fish-Eye Effect)	61
Shots Resembling Miniature Models (Miniature Effect).....	62
Playback Speed and Estimated Playback Time (for One-Minute Clips)	62
Shooting with a Toy Camera Effect (Toy Camera Effect).....	63
Shooting with a Soft Focus Effect.....	63
Shooting in Monochrome.....	64
Special Modes for Other Purposes	64
Auto Shooting after Face Detection (Smart Shutter).....	64
Auto Shooting after Smile Detection (Smile)	64
Auto Shooting after Wink Detection (Wink Self-Timer).....	65

Before Use
Basic Guide
Advanced Guide
Camera Basics
Auto Mode / Hybrid Auto Mode
Other Shooting Modes
P Mode
Tv, Av, and M Mode
Playback Mode
Wireless Features
Setting Menu
Accessories
Appendix
Index



Auto Shooting after Detecting New Person (Face Self-Timer).....	66
Recording Various Movies.....	67
Recording Movies in Standard Mode	67
Shooting Movies with Smoother Motion	67
Locking or Changing Image Brightness	67
Disabling Auto Slow Shutter	68
Correcting Severe Camera Shake	68
Sound Settings	68
Deactivating the Wind Filter	68
Using the Attenuator.....	68
Recording Movies in Short Clip Mode	69
Playback Effects	69
P Mode	70
Shooting in Program AE ([P] Mode)	70
Image Brightness (Exposure).....	71
Adjusting Image Brightness (Exposure Compensation).....	71
Locking Image Brightness / Exposure (AE Lock)	71
Changing the Metering Method	71
Changing the ISO Speed.....	72
Correcting Image Brightness (i-Contrast).....	72
Image Colors	73
Capturing Natural Colors (White Balance)	73
Custom White Balance.....	73
Changing Image Color Tones (My Colors)	74
Custom Color.....	74
Shooting Range and Focusing	75
Shooting Close-Ups (Macro)	75
Shooting in Manual Focus Mode.....	75
Easily Identifying the Focus Area (MF Peaking).....	76
Digital Tele-Converter	77

Changing the AF Frame Mode	77
Center.....	77
Face AiAF	77
Choosing Subjects to Focus On (Tracking AF)	78
Shooting with Servo AF	79
Changing the Focus Setting	79
Shooting with the AF Lock.....	80
Shooting Continuously as the Camera Keeps the Subject in Focus.....	80
Flash.....	81
Changing the Flash Mode	81
Auto.....	81
On.....	81
Slow Synchro	81
Off.....	81
Adjusting the Flash Exposure Compensation.....	82
Shooting with the FE Lock.....	82
Other Settings	83
Changing the Compression Ratio (Image Quality).....	83
Changing the IS Mode Settings.....	83
Tv, Av, and M Mode	84
Specific Shutter Speeds ([Tv] Mode).....	84
Specific Aperture Values ([Av] Mode).....	85
Specific Shutter Speeds and Aperture Values ([M] Mode)	85
Adjusting the Flash Output	86
Playback Mode	87
Viewing.....	87
Switching Display Modes.....	88
Overexposure Warning (for Image Highlights)	89
Histogram	89
GPS Information Display	89

Before Use
Basic Guide
Advanced Guide
Camera Basics
Auto Mode / Hybrid Auto Mode
Other Shooting Modes
P Mode
Tv, Av, and M Mode
Playback Mode
Wireless Features
Setting Menu
Accessories
Appendix
Index

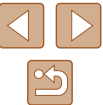

Viewing Short Movies Recorded in Creative Shot Mode (Creative Shot Movies)	89
Viewing Short Movies Created When Shooting Still Images (Digest Movies).....	90
Viewing by Date.....	90
Checking People Detected in Face ID.....	90
Browsing and Filtering Images	91
Navigating through Images in an Index.....	91
Finding Images Matching Specified Conditions.....	91
Viewing Individual Images in a Group	92
Editing Face ID Information.....	93
Changing Names.....	93
Erasing Names.....	93
Image Viewing Options	94
Magnifying Images	94
Viewing Slideshows.....	94
Changing Slideshow Settings.....	95
Auto Playback of Related Images (Smart Shuffle).....	95
Protecting Images	96
Using the Menu	96
Choosing Images Individually.....	96
Selecting a Range	97
Protecting All Images at Once	97
Clearing All Protection at Once	97
Erasing Images	98
Erasing Multiple Images at Once.....	98
Choosing a Selection Method	98
Choosing Images Individually.....	99
Selecting a Range	99
Specifying All Images at Once.....	99

Rotating Images	100
Using the Menu	100
Deactivating Auto Rotation	100
Tagging Images as Favorites	101
Using the Menu	101
Editing Still Images.....	102
Resizing Images.....	102
Cropping.....	102
Changing Image Color Tones (My Colors)	103
Correcting Image Brightness (i-Contrast).....	104
Correcting Red-Eye.....	104
Editing Movies	105
Reducing File Sizes.....	106
Erasing Movie Chapters	107
Viewing Albums (Story Highlights)	108
Choosing Themes for Albums	108
Adding Background Music to Albums	109
Creating Your Own Albums.....	110
Combining Short Clips.....	111
Wireless Features	112
Available Wireless Features.....	112
Using Wi-Fi Features.....	112
Using Bluetooth® Features	112
Sending Images to a Smartphone.....	113
Transferring Images to a Bluetooth Enabled Smartphone	113
Transferring Images to an NFC-Compatible Smartphone	115
Connecting via NFC When Camera Is Off or in Shooting Mode	115
Connecting via NFC When Camera Is in Playback Mode.....	117
Adding a Smartphone Using the Wi-Fi Menu	117
Using Another Access Point	119

Before Use
Basic Guide
Advanced Guide
Camera Basics
Auto Mode / Hybrid Auto Mode
Other Shooting Modes
P Mode
Tv, Av, and M Mode
Playback Mode
Wireless Features
Setting Menu
Accessories
Appendix
Index



Previous Access Points	120
Saving Images to a Computer	120
Preparing to Register a Computer	120
Installing CameraWindow	120
Configuring the Computer for a Wi-Fi Connection (Windows Only)	121
Saving Images to a Connected Computer	122
Confirming Access Point Compatibility	122
Using WPS-Compatible Access Points	122
Connecting to Listed Access Points	124
Previous Access Points	125
Sending Images to a Registered Web Service	126
Registering Web Services	126
Registering CANON iMAGE GATEWAY	126
Registering Other Web Services	128
Uploading Images to Web Services	128
Printing Images Wirelessly from a Connected Printer	129
Sending Images to Another Camera	131
Image Sending Options	132
Sending Multiple Images	132
Selecting a Range	133
Sending Favorite Images	133
Notes on Sending Images	133
Choosing the Number of Recording Pixels (Image Size)	134
Adding Comments	134
Sending Images Automatically (Image Sync)	134
Initial Preparations	134
Preparing the Camera	134
Preparing the Computer	135
Sending Images	135
Viewing Images Sent via Image Sync on a Smartphone	136

Using a Smartphone to View Camera Images and Control the Camera	136
Geotagging Images When You Shoot	136
Controlling the Camera Remotely from a Smartphone	138
Controlling the Camera via Wi-Fi	138
Controlling the Camera via Bluetooth	138
Editing or Erasing Wi-Fi Settings	139
Editing Connection Information	139
Changing a Device Nickname	140
Erasing Connection Information	140
Specifying Images Viewable from Smartphones	140
Changing the Camera Nickname	141
Returning the Wi-Fi Settings to Default	141
Clearing Information of Devices Paired via Bluetooth	142

Setting Menu	143
Adjusting Basic Camera Functions	143
Silencing Camera Operations	143
Adjusting the Volume	143
Hiding Hints and Tips	144
Date and Time	144
World Clock	144
Lens Retraction Timing	145
Using Eco Mode	145
Power-Saving Adjustment	145
Screen Brightness	145
Hiding the Start-Up Screen	146
Formatting Memory Cards	146
Low-Level Formatting	147
File Numbering	147
Date-Based Image Storage	148
Metric / Non-Metric Display	148
Checking Certification Logos	148

Before Use
Basic Guide
Advanced Guide
Camera Basics
Auto Mode / Hybrid Auto Mode
Other Shooting Modes
P Mode
Tv, Av, and M Mode
Playback Mode
Wireless Features
Setting Menu
Accessories
Appendix
Index

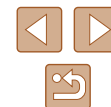

Display Language.....	148
Adjusting Other Settings.....	149
Restoring Default Camera Settings.....	149
Restoring All Camera Defaults.....	149
Restoring Defaults for Individual Functions.....	149
Accessories.....	150
System Map.....	150
Optional Accessories.....	151
Power Supplies.....	151
Other Accessories.....	152
Printers.....	152
Photo and Movie Storage.....	152
Using Optional Accessories.....	152
Playback on a TV.....	152
Playback on a High-Definition TV.....	152
Inserting and Charging the Battery Pack.....	153
Using a Computer to Charge the Battery.....	155
Using the Software.....	155
Computer Connections via a Cable.....	156
Checking Your Computer Environment.....	156
Installing the Software.....	156
Saving Images to a Computer.....	156
Printing Images.....	157
Easy Print.....	157
Configuring Print Settings.....	158
Cropping Images before Printing.....	159
Choosing Paper Size and Layout before Printing.....	159
Available Layout Options.....	160
Printing ID Photos.....	160
Printing Movie Scenes.....	160
Movie Printing Options.....	160

Adding Images to the Print List (DPOF).....	161
Configuring Print Settings.....	161
Setting Up Printing for Individual Images.....	161
Setting Up Printing for a Range of Images.....	162
Setting Up Printing for All Images.....	162
Clearing All Images from the Print List.....	162
Printing Images Added to the Print List (DPOF).....	162
Adding Images to a Photobook.....	163
Choosing a Selection Method.....	163
Adding Images Individually.....	163
Adding All Images to a Photobook.....	163
Removing All Images from a Photobook.....	163
Appendix.....	164
Troubleshooting.....	164
On-Screen Messages.....	168
On-Screen Information.....	170
Shooting (Information Display).....	170
Battery Level.....	170
Playback (Detailed Information Display).....	171
Summary of Movie Control Panel.....	171
Functions and Menu Tables.....	172
Functions Available in Each Shooting Mode.....	172
FUNC. Menu.....	173
Shooting Tab.....	175
Set Up Tab.....	179
Playback Tab.....	179
Print Tab.....	180
Playback Mode FUNC. Menu.....	180
Handling Precautions.....	180
Specifications.....	181
Image Sensor.....	181

Before Use
Basic Guide
Advanced Guide
Camera Basics
Auto Mode / Hybrid Auto Mode
Other Shooting Modes
P Mode
Tv, Av, and M Mode
Playback Mode
Wireless Features
Setting Menu
Accessories
Appendix
Index

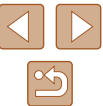

Lens.....	181
Shutter.....	181
Aperture.....	181
Flash.....	181
Monitor.....	182
Shooting.....	182
Recording.....	182
Power.....	183
Interface.....	183
Operating Environment.....	183
Dimensions (CIPA compliant).....	183
Weight (CIPA compliant).....	184
Battery Pack NB-13L.....	184
Battery Charger CB-2LH/CB-2LHE.....	184
Compact Power Adapter CA-DC30/CA-DC30E.....	184
Index.....	185
Precautions for Wireless Features (Wi-Fi, Bluetooth, or Others).....	187
Radio Wave Interference Precautions.....	187
Security Precautions.....	187
Third-Party Software.....	188
Personal Information and Security Precautions.....	189
Trademarks and Licensing.....	189
Disclaimer.....	189

Before Use
Basic Guide
Advanced Guide
Camera Basics
Auto Mode / Hybrid Auto Mode
Other Shooting Modes
P Mode
Tv, Av, and M Mode
Playback Mode
Wireless Features
Setting Menu
Accessories
Appendix
Index



Common Camera Operations

Shoot

- Use camera-determined settings (Auto Mode, Hybrid Auto Mode)
 - 33, 35
- See several effects applied to each shot, using camera-determined settings (Creative Shot Mode)
 - 56
- Shoot yourself under optimal settings (Self Portrait)
 - 58

Shooting people well



Portraits
(59)

Matching specific scenes



Sports
(59)



Night Scenes
(59)



Low Light
(59)



Fireworks
(59)

Applying special effects



Vivid Colors
(60)



Fish-Eye Effect
(61)



Soft Focus
(63)



Poster Effect
(60)



Miniature Effect
(62)



Monochrome
(64)



Smooth Skin
(61)



Toy Camera Effect
(63)

- Focus on faces
 - 33, 59, 77
- Without using the flash (Flash Off)
 - 33
- Include yourself in the shot (Self-Timer)
 - 43, 66
- Add a date stamp
 - 42
- Movie clips and photos together (Movie Digest)
 - 35

Before Use

Basic Guide

Advanced Guide

Camera Basics

Auto Mode /
Hybrid Auto Mode

Other Shooting Modes

P Mode

Tv, Av, and M Mode

Playback Mode

Wireless Features

Setting Menu







Accessories

Appendix



Index



View

- View images (Playback Mode)
 -  87
- Automatic playback (Slideshow)
 -  94
- On a TV
 -  152
- On a computer
 -  156
- Browse through images quickly
 -  91
- Erase images
 -  98
- Create an album automatically
 -  108

Record/View Movies

- Record movies
 -  33,  67
- View movies (Playback Mode)
 -  87



Print

- Print pictures
 -  157

Save

- Save images to a computer
 -  156

Use Wi-Fi Features

- Send images to a smartphone
 -  113
- Share images online
 -  126
- Send images to a computer
 -  134

Before Use

Basic Guide

Advanced Guide

Camera Basics

Auto Mode / Hybrid Auto Mode

Other Shooting Modes

P Mode

Tv, Av, and M Mode

Playback Mode

Wireless Features

Setting Menu

Accessories

Appendix

Index

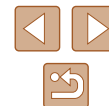

Safety Instructions

- Be sure to read these instructions in order to operate the product safely.
- Follow these instructions to prevent injury or harm to the operator of the product or others.



WARNING

Denotes the risk of serious injury or death.

- Keep the product out of the reach of young children. A strap wrapped around a person's neck may result in strangulation. The accessory shoe cover is dangerous if swallowed. If swallowed, seek immediate medical assistance.
- Use only power sources specified in this instruction manual for use with the product.
- Do not disassemble or modify the product.
- Do not expose the product to strong shocks or vibration.
- Do not touch any exposed internal parts.
- Stop using the product in any case of unusual circumstances such as the presence of smoke or a strange smell.
- Do not use organic solvents such as alcohol, benzene or paint thinner to clean the product.
- Do not get the product wet. Do not insert foreign objects or liquids into the product.
- Do not insert foreign objects or liquids into the product.
- Do not use the product where flammable gases may be present. This may cause electric shock, explosion or fire.
- For products featuring a viewfinder, do not look through the viewfinder at strong light sources such as the sun on a bright day or lasers and other strong artificial light sources. This may harm your vision.

- Observe the following instructions when using commercially available batteries or provided battery packs.
 - Use batteries/battery packs only with their specified product.
 - Do not heat batteries/battery packs or expose them to fire.
 - Do not charge batteries/battery packs using non-authorized battery chargers.
 - Do not expose the terminals to dirt or let them come into contact with metallic pins or other metal objects.
 - Do not use leaking batteries/battery packs.
 - When disposing of batteries/battery packs, insulate the terminals with tape or other means.

This may cause electric shock, explosion or fire. If a battery/battery pack leaks and the material contacts your skin or clothing, flush the exposed area thoroughly with running water. In case of eye contact, flush thoroughly with copious amounts of clean running water and seek immediate medical assistance.

- Observe the following instructions when using a battery charger.
- Observe the following instructions when using a battery charger or AC adapter.
 - Periodically remove any dust buildup from the power plug and power outlet using a dry cloth.
 - Do not plug in or unplug the product with wet hands.
 - Do not use the product if the power plug is not fully inserted into the power outlet.
 - Do not expose the power plug and terminals to dirt or let them come into contact with metallic pins or other metal objects.
 - Do not touch the battery charger or AC adapter connected to a power outlet during lightning storms.
 - Do not place heavy objects on the power cord. Do not damage, break or modify the power cord.
 - Do not wrap the product in cloth or other materials when in use or shortly after use when the product is still warm in temperature.
 - Do not leave the product connected to a power source for long periods of time.

This may cause electric shock, explosion or fire.

Before Use

Basic Guide

Advanced Guide

Camera Basics

Auto Mode /
Hybrid Auto Mode

Other Shooting Modes

P Mode

Tv, Av, and M Mode

Playback Mode

Wireless Features

Setting Menu

Accessories

Appendix

Index



- Do not allow the product to maintain contact with the same area of skin for extended periods of time during use.

This may result in low-temperature contact burns, including skin redness and blistering, even if the product does not feel hot. The use of a tripod or similar equipment is recommended when using the product in hot places and for people with circulation problems or less sensitive skin.

- Follow any indications to turn off the product in places where its use is forbidden.

Not doing so may cause other equipment to malfunction due to the effect of electromagnetic waves and even result in accidents.

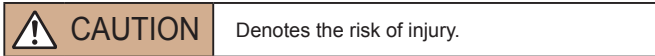

- Do not fire the flash near the eyes. It may hurt the eyes.

- Strap is intended for use on the body only. Hanging the strap with any product attached on a hook or other object may damage the product. Also, do not shake the product or expose the product to strong impacts.

- Do not apply strong pressure on the lens or allow an object to hit it. This may cause injury or damage to the product.

- Flash emits high temperatures when fired. Keep fingers, any other part of your body, and objects away from the flash unit while taking pictures.

This may cause burns or malfunction of the flash.

- Do not leave the product in places exposed to extremely high or low temperatures.

The product may become extremely hot/cold and cause burns or injury when touched.

Caution

Denotes the possibility of property damage.

- Do not aim the camera at intense light sources, such as the sun on a clear day or an intense artificial light source.

Doing so may damage the image sensor or other internal components.

- When using the camera on a sandy beach or at a windy location, be careful not to allow dust or sand to enter the camera.

- Wipe off any dust, grime, or other foreign matter on the flash with a cotton swab or cloth.

The heat emitted from the flash may cause foreign matter to smoke or the product to malfunction.

- Remove and store the battery pack/batteries when you are not using the product.

Any battery leakage that occurs may cause product damage.

- Before you discard the battery pack/batteries, cover the terminals with tape or other insulators.

Contacting other metal materials may lead to fire or explosions.

- Unplug any battery charger used with the product when not in use. Do not cover with a cloth or other objects when in use.

Leaving the unit plugged in for a long period of time may cause it to overheat and distort, resulting in fire.

- Do not leave any dedicated battery packs near pets.

Pets biting the battery pack could cause leakage, overheating, or explosion, resulting in product damage or fire.

- If your product uses multiple batteries, do not use batteries that have different levels of charge together, and do not use old and new batteries together. Do not insert the batteries with the + and – terminals reversed.

This may cause the product to malfunction.

- Do not sit down with the camera in your pant pocket.

Doing so may cause malfunctions or damage the screen.

Before Use

Basic Guide

Advanced Guide

Camera Basics

Auto Mode /
Hybrid Auto Mode

Other Shooting Modes

P Mode

Tv, Av, and M Mode

Playback Mode

Wireless Features

Setting Menu

Accessories

Appendix

Index



- When putting the camera in your bag, ensure that hard objects do not come into contact with the screen. Also close the screen (so that it faces the body), if your product's screen closes.
- Do not attach any hard objects to the product. Doing so may cause malfunctions or damage the screen.



Before Use
Basic Guide
Advanced Guide
Camera Basics
Auto Mode / Hybrid Auto Mode
Other Shooting Modes
P Mode
Tv, Av, and M Mode
Playback Mode
Wireless Features
Setting Menu
Accessories
Appendix
Index

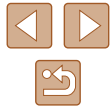

Basic Guide

Basic Operations

Basic information and instructions, from initial preparations to shooting and playback

Initial Preparations

Prepare for shooting as follows.

Attaching the Strap

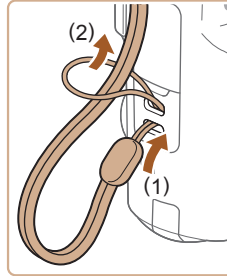

- Thread the end of the strap through the strap mount (1), and then pull the other end of the strap through the loop on the threaded end (2).

Holding the Camera

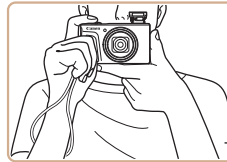

- Place the strap around your wrist.
- When shooting, keep your arms close to your body and hold the camera securely to prevent it from moving. If you have raised the flash, do not rest your fingers on it.

Before Use

Basic Guide

Advanced Guide

Camera Basics

Auto Mode /
Hybrid Auto Mode

Other Shooting Modes

P Mode

Tv, Av, and M Mode

Playback Mode

Wireless Features

Setting Menu

Accessories

Appendix

Index

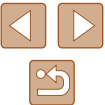

Charging the Battery Pack

Before use, charge the battery pack with the included charger. Be sure to charge the battery pack initially, because the camera is not sold with the battery pack charged.

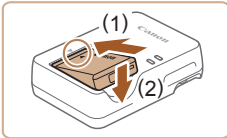

1 Insert the battery pack.

- After aligning the ▲ marks on the battery pack and charger, insert the battery pack by pushing it in (1) and down (2).

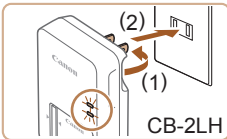

2 Charge the battery pack.

- CB-2LH: Flip out the plug (1) and plug the charger into a power outlet (2).
- CB-2LHE: Plug the power cord into the charger, then plug the other end into a power outlet.
- The charging lamp turns orange, and charging begins.
- When charging is finished, the lamp turns green.

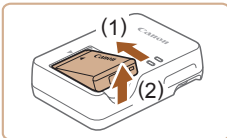
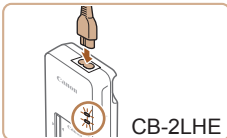

3 Remove the battery pack.

- After unplugging the battery charger, remove the battery pack by pushing it in (1) and up (2).



- To protect the battery pack and keep it in optimal condition, do not charge it continuously for more than 24 hours.
- For battery chargers that use a power cord, do not attach the charger or cord to other objects. Doing so could result in malfunction or damage to the product.



- For details on charging time and the number of shots and recording time possible with a fully charged battery pack, see “Power” (📖183) and “Battery Charger CB-2LH/CB-2LHE” (📖184).
- Charged battery packs gradually lose their charge, even when they are not used. Charge the battery pack on (or immediately before) the day of use.
- The charger can be used in areas with 100 – 240 V AC power (50/60 Hz). For power outlets in a different format, use a commercially available adapter for the plug. Never use an electrical transformer designed for traveling, which may damage the battery pack.

Inserting the Battery Pack and Your Memory Card

Insert the included battery pack and a memory card (sold separately). Note that before using a memory card that is new or has been formatted in another device, you should format the memory card with this camera (📖146).

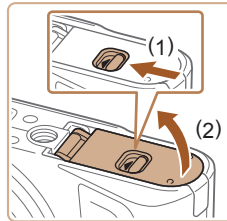

1 Open the cover.

- Slide the switch (1) and open the cover (2).

Before Use

Basic Guide

Advanced Guide

Camera Basics

Auto Mode /
Hybrid Auto Mode

Other Shooting Modes

P Mode

Tv, Av, and M Mode

Playback Mode

Wireless Features

Setting Menu

Accessories

Appendix

Index



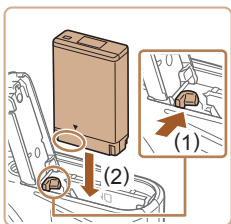

2 Insert the battery pack.

- Holding the battery pack with the terminals in the position shown, hold the battery lock toward (1) and insert the battery pack toward (2) until the lock clicks shut.
- If you insert the battery pack facing the wrong way, it cannot be locked into the correct position. Always confirm that the battery pack is facing the right way and locks when inserted.

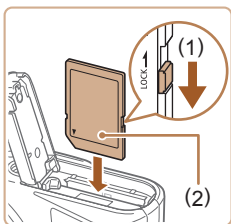

3 Check your card's write-protect switch and insert the memory card.

- Recording is not possible on memory cards with a write-protect switch when the switch is in the locked position. Move the switch toward (1).
- Insert the memory card with the label (2) facing as shown until it clicks into place.
- Make sure the memory card is facing the right way when you insert it. Inserting memory cards facing the wrong way may damage the camera.

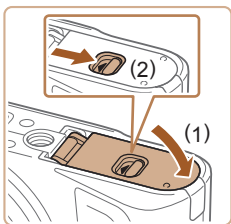

4 Close the cover.

- Lower the cover (1) and hold it down as you slide the switch, until it clicks into the closed position (2).



- For guidelines on how many shots or hours of recording can be saved on one memory card, see "Recording" (182).

Removing the Battery Pack and Memory Card

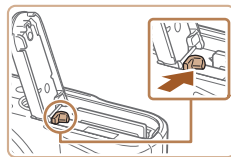

Remove the battery pack.

- Open the cover and press the battery lock in the direction of the arrow.
- The battery pack will pop up.

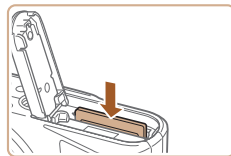

Remove the memory card.

- Push the memory card in until it clicks, and then slowly release it.
- The memory card will pop up.

Setting the Date and Time

Set the current date and time correctly as follows if the [Date/Time] screen is displayed when you turn the camera on. Information you specify this way is recorded in image properties when you shoot, and it is used when you manage images by shooting date or print images showing the date.

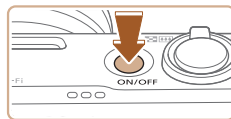

1 Turn the camera on.

- Press the power button.
- The [Date/Time] screen is displayed.

Before Use

Basic Guide

Advanced Guide

Camera Basics

Auto Mode /
Hybrid Auto Mode

Other Shooting Modes

P Mode

Tv, Av, and M Mode

Playback Mode

Wireless Features

Setting Menu

Accessories

Appendix

Index



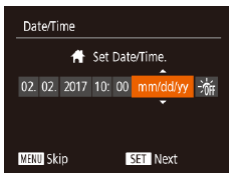

2 Set the date and time.

- Press the [◀][▶] buttons to choose an item.
- Press the [▲][▼] buttons or turn the [DISP] dial to specify the date and time.
- When finished, press the [MENU] button.

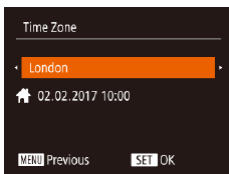

3 Specify your home time zone.

- Press the [◀][▶] buttons to choose your home time zone.

4 Finish the setup process.

- Press the [MENU] button when finished. After a confirmation message, the setting screen is no longer displayed.
- To turn off the camera, press the power button.



- Unless you set the date, time, and home time zone, the [Date/Time] screen will be displayed each time you turn the camera on. Specify the correct information.



- To set daylight saving time (1 hour ahead), choose [DST] in step 2 and then choose [ON] by pressing the [▲][▼] buttons or turning the [DISP] dial.

Changing the Date and Time

Adjust the date and time as follows.



1 Access the menu screen.

- Press the [MENU] button.

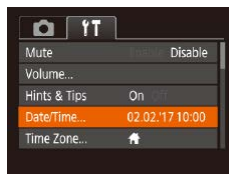

2 Choose [Date/Time].

- Move the zoom lever to choose the [ZOOM] tab.
- Press the [▲][▼] buttons or turn the [DISP] dial to choose [Date/Time], and then press the [MENU] button.

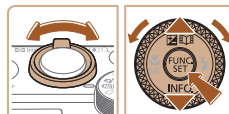

3 Change the date and time.

- Follow step 2 in “Setting the Date and Time” (19) to adjust the settings.
- Press the [MENU] button to close the menu screen.



- Date/time settings can be retained for about 3 weeks by the camera's built-in date/time battery (backup battery) after the battery pack is removed.
- The date/time battery will be charged in about 4 hours once you insert a charged battery pack, even if the camera is left off.
- Once the date/time battery is depleted, the [Date/Time] screen will be displayed when you turn the camera on. Set the correct date and time as described in “Setting the Date and Time” (19).

Before Use
Basic Guide
Advanced Guide
Camera Basics
Auto Mode / Hybrid Auto Mode
Other Shooting Modes
P Mode
Tv, Av, and M Mode
Playback Mode
Wireless Features
Setting Menu
Accessories
Appendix
Index



Display Language

Change the display language as needed.

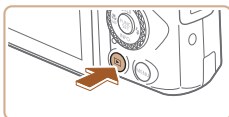

1 Enter Playback mode.

- Press the [▶] button.

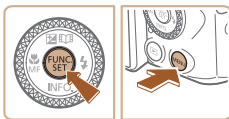

2 Access the setting screen.

- Press and hold the [FUNC SET] button, and then immediately press the [MENU] button.

English	Norsk	Română
Deutsch	Svenska	Türkçe
Français	Español	العربية
Nederlands	Ελληνικά	ភាសាខ្មែរ
Dansk	Русский	简体中文
Português	PolSKI	繁體中文
Suomi	Čeština	한국어

3 Set the display language.

- Press the [▲][▼][◀][▶] buttons or turn the [MODE] dial to choose a language, and then press the [FUNC SET] button.
- Once the display language has been set, the setting screen is no longer displayed.



- The current time is displayed if you wait too long in step 2 after pressing the [FUNC SET] button before you press the [MENU] button. In this case, press the [FUNC SET] button to dismiss the time display and repeat step 2.
- You can also change the display language by pressing the [MENU] button and choosing [Language] on the [INFO] tab.

Trying the Camera Out

▶ Still Images ▶ Movies

Try out the camera by turning it on, shooting some still images or movies, and viewing them.

Shooting (Smart Auto)

For fully automatic selection of the optimal settings for specific scenes, simply let the camera determine the subject and shooting conditions.

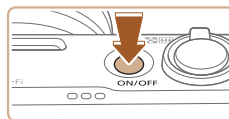

1 Turn the camera on.

- Press the power button.
- The startup screen is displayed.



2 Enter [AUTO] mode.

- Set the mode dial to [AUTO].
- Aim the camera at the subject. The camera will make a slight clicking noise as it determines the scene.
- Icons representing the scene and image stabilization mode are displayed in the upper left of the screen.
- Frames displayed around any detected subjects indicate that they are in focus.

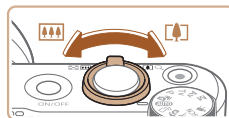
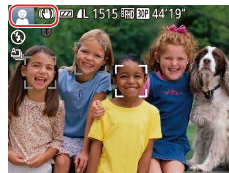

3 Compose the shot.

- To zoom in and enlarge the subject, move the zoom lever toward [TEL] (telephoto), and to zoom away from the subject, move it toward [WIDE] (wide angle).

Before Use

Basic Guide

Advanced Guide

Camera Basics

Auto Mode /
Hybrid Auto Mode

Other Shooting Modes

P Mode

Tv, Av, and M Mode

Playback Mode

Wireless Features

Setting Menu

Accessories

Appendix

Index



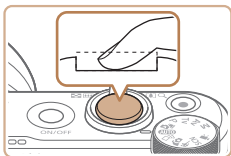
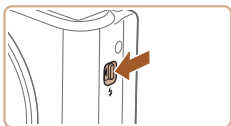
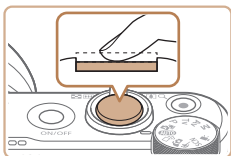

4 Shoot.

Shooting Still Images

1) Focus.

- Press the shutter button lightly, halfway down. The camera beeps twice after focusing, and frames are displayed to indicate image areas in focus.

- If [Raise the flash] is displayed, move the  switch to raise the flash. It will fire when shooting. If you prefer not to use the flash, push it down with your finger, into the camera.

2) Shoot.

- Press the shutter button all the way down.
- As the camera shoots, a shutter sound is played, and in low-light conditions when you have raised the flash, it fires automatically.
- Keep the camera still until the shutter sound ends.
- After displaying your shot, the camera will revert to the shooting screen.

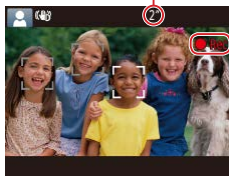

Recording Movies

1) Start recording.

- Press the movie button. The camera beeps once as recording begins, and [●Rec] is displayed with the elapsed time (1).
- Black bars are displayed on the top and bottom edges of the screen, and the subject is slightly enlarged. The black bars indicate image areas not recorded.
- Frames displayed around any detected faces indicate that they are in focus.
- Once recording begins, take your finger off the movie button.

2) Finish recording.

- Press the movie button again to stop recording. The camera beeps twice as recording stops.

Before Use
Basic Guide
Advanced Guide
Camera Basics
Auto Mode / Hybrid Auto Mode
Other Shooting Modes
P Mode
Tv, Av, and M Mode
Playback Mode
Wireless Features
Setting Menu
Accessories
Appendix
Index

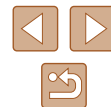

Viewing

After shooting images or movies, you can view them on the screen as follows.

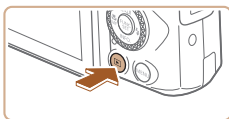

1 Enter Playback mode.

- Press the [▶] button.
- Your last shot is displayed.



2 Choose images.

- To view the previous image, press the [◀] button or turn the [●] dial counterclockwise. To view the next image, press the [▶] button or turn the [●] dial clockwise.
- Press and hold the [◀▶] buttons to browse through images quickly.
- To access this screen (Scroll Display mode), turn the [●] dial rapidly. In this mode, turn the [●] dial to browse through images.
- To return to single-image display, press the [SET] button.
- Movies are identified by a [SET ▶] icon. To play movies, go to step 3.

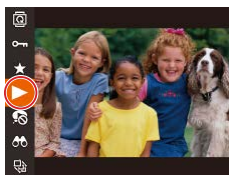
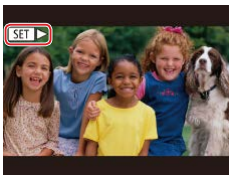
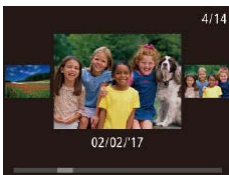

3 Play movies.

- Press the [SET] button, choose [▶] (either press the [▲][▼] buttons or turn the [●] dial), and then press the [SET] button again.
- Playback now begins, and after the movie is finished, [SET ▶] is displayed.
- To adjust the volume, press the [▲][▼] buttons during playback.



- To switch to Shooting mode from Playback mode, press the shutter button halfway.

Before Use
Basic Guide
Advanced Guide
Camera Basics
Auto Mode / Hybrid Auto Mode
Other Shooting Modes
P Mode
Tv, Av, and M Mode
Playback Mode
Wireless Features
Setting Menu
Accessories
Appendix
Index

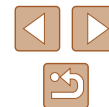

Erasing Images

You can choose and erase unneeded images one by one. Be careful when erasing images, because they cannot be recovered.



1 Choose an image to erase.

- Press the [◀][▶] buttons or turn the [🌀] dial to choose an image.



2 Erase the image.

- Press the [🗑️] button.
- After [Erase?] is displayed, press the [◀][▶] buttons or turn the [🌀] dial to choose [Erase], and then press the [👉] button.
- The current image is now erased.
- To cancel erasure, press the [◀][▶] buttons or turn the [🌀] dial to choose [Cancel], and then press the [👉] button.



- You can choose multiple images to erase at once (📖98).

Before Use

Basic Guide

Advanced Guide

Camera Basics

Auto Mode /
Hybrid Auto Mode

Other Shooting Modes

P Mode

Tv, Av, and M Mode

Playback Mode

Wireless Features

Setting Menu

Accessories

Appendix

Index

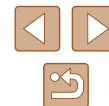

Advanced Guide

Camera Basics

Other basic operations and more ways to enjoy your camera, including shooting and playback options

On/Off

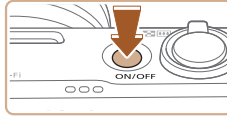

Shooting Mode

- Press the power button to turn the camera on and prepare for shooting.
- To turn the camera off, press the power button again.

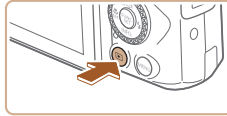

Playback Mode

- Press the [▶] button to turn the camera on and view your shots.
- To turn the camera off, press the [▶] button again.



- To switch to Playback mode from Shooting mode, press the [▶] button.
- To switch to Shooting mode from Playback mode, press the shutter button halfway (p. 26).
- The lens will be retracted after about one minute once the camera is in Playback mode. You can turn the camera off when the lens is retracted by pressing the [▶] button.

Before Use

Basic Guide

Advanced Guide

Camera Basics

Auto Mode /
Hybrid Auto Mode

Other Shooting Modes

P Mode

Tv, Av, and M Mode

Playback Mode

Wireless Features

Setting Menu

Accessories

Appendix

Index

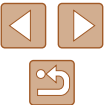

Power-Saving Features (Auto Power Down)

As a way to conserve battery power, the camera automatically deactivates the screen (Display Off) and then turns itself off after a specific period of inactivity.

Power Saving in Shooting Mode

The screen is automatically deactivated after about one minute of inactivity. In about two more minutes, the lens is retracted and the camera turns itself off. To activate the screen and prepare for shooting when the screen is off but the lens is still out, press the shutter button halfway (📖26).

Power Saving in Playback Mode

The camera turns itself off automatically after about five minutes of inactivity.



- You can deactivate Auto Power Down and adjust the timing of Display Off, if you prefer (📖145).
- Power saving is not active while the camera is connected to other devices via Wi-Fi (📖112), or when connected to a computer (📖156).

Shutter Button

To ensure your shots are in focus, always begin by holding the shutter button halfway down, and once the subject is in focus, press the button all the way down to shoot.

In this guide, shutter button operations are described as pressing the button *halfway* or *all the way down*.

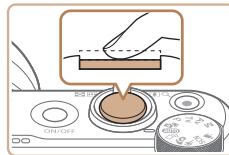

1 Press halfway. (Press lightly to focus.)

- Press the shutter button halfway. The camera beeps twice, and frames are displayed around image areas in focus.

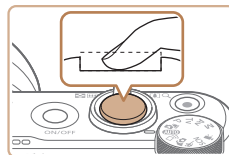

2 Press all the way down. (From the halfway position, press fully to shoot.)

- The camera shoots, as a shutter sound is played.
- Keep the camera still until the shutter sound ends.



- Images may be out of focus if you shoot without initially pressing the shutter button halfway.
- Length of shutter sound playback varies depending on the time required for the shot. It may take longer in some shooting scenes, and images will be blurry if you move the camera (or the subject moves) before the shutter sound ends.

Before Use

Basic Guide

Advanced Guide

Camera Basics

Auto Mode /
Hybrid Auto Mode

Other Shooting Modes

P Mode

Tv, Av, and M Mode

Playback Mode

Wireless Features

Setting Menu

Accessories

Appendix

Index



Shooting Modes

Use the mode dial to access each shooting mode.

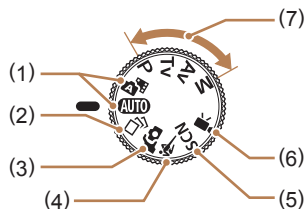

- | | |
|---|--|
| <p>(1) Auto Mode / Hybrid Auto Mode
Fully automatic shooting, with camera-determined settings (📖21, 📖33, 📖35).</p> <p>(2) Creative Shot Mode
See several effects applied to each shot automatically (📖56).</p> <p>(3) Self Portrait Mode
Shoot yourself under optimal settings (📖58).</p> <p>(4) Sports Mode
Shoot continuously as the camera focuses on moving subjects (📖59).</p> | <p>(5) Special Scene Mode
Shoot with settings designed for specific scenes, or add a variety of effects (📖59).</p> <p>(6) Movie Mode
For shooting movies (📖67). You can also shoot movies when the mode dial is not set to Movie mode, simply by pressing the movie button.</p> <p>(7) P, Tv, Av, and M Modes
Take a variety of shots using your preferred settings (📖70, 📖84).</p> |
|---|--|

Shooting Display Options

Press the [▼] button to view other information on the screen, or to hide the information. For details on the information displayed, see “On-Screen Information” (📖170).

	<p>Information is displayed</p>
	<p>No information is displayed</p>



- Screen brightness is automatically increased by the night view function when you are shooting under low light, making it easier to check how shots are composed. However, on-screen image brightness may not match the brightness of your shots. Note that any on-screen image distortion or jerky subject motion will not affect recorded images.
- For playback display options, see “Switching Display Modes” (📖88).

Before Use

Basic Guide

Advanced Guide

Camera Basics

Auto Mode /
Hybrid Auto Mode

Other Shooting Modes

P Mode

Tv, Av, and M Mode

Playback Mode

Wireless Features

Setting Menu

Accessories

Appendix

Index



Adjusting the Screen Angle

You can adjust the screen angle and orientation to suit the scene or how you are shooting.

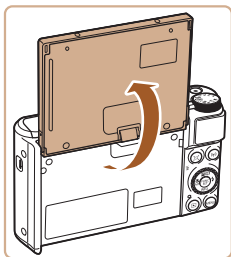

- The screen can be opened to about 180°.
- When including yourself in shots, you can view a mirror image of yourself by rotating the screen around toward the front of the camera.



- When the camera is not in use, keep the screen closed.
- Do not force the screen open too far, which may damage the camera.



- To cancel reverse display, choose MENU (📖29) > [📷] tab > [Reverse Display] > [Off].

Using the FUNC. Menu

Configure commonly used shooting functions through the FUNC. menu as follows.

Note that menu items and options vary depending on the shooting mode (📖173).



1 Access the FUNC. menu.

- Press the [FUNC.] button.



(1)(2)

2 Choose a menu item.

- Press the [▲][▼] buttons or turn the [DISP.] dial to choose a menu item (1), and then press the [FUNC.] or [▶] button.
- Available options (2) are listed next to menu items, on the right.
- Depending on the menu item, functions can be specified simply by pressing the [FUNC.] or [▶] button, or another screen is displayed for configuring the function.



3 Choose an option.

- Press the [▲][▼] buttons or turn the [DISP.] dial to choose an option.
- Items labeled with a [MENU] icon can be configured by pressing the [MENU] button.
- To return to the menu items, press the [◀] button.

Before Use

Basic Guide

Advanced Guide

Camera Basics

Auto Mode /
Hybrid Auto Mode

Other Shooting Modes

P Mode

Tv, Av, and M Mode

Playback Mode

Wireless Features

Setting Menu

Accessories

Appendix

Index





4 Confirm your choice and exit.

- Press the **[MENU]** button.
- The screen before you pressed the **[MENU]** button in step 1 is displayed again, showing the option you configured.



- To undo any accidental setting changes, you can restore the camera's default settings (149).

Using the Menu Screen

Configure a variety of camera functions through the menu screen as follows. Menu items are grouped by purpose on tabs, such as shooting **[CAMERA]**, playback **[PLAY]**, and so on. Note that available menu items vary depending on the selected shooting or playback mode (175 – 179).



1 Access the menu screen.

- Press the **[MENU]** button.



2 Choose a tab.

- Move the zoom lever to choose a tab.
- After you have pressed the **[▲]**/**[▼]** buttons or turned the **[DIAL]** to choose a tab initially, you can switch between tabs by pressing the **[◀]**/**[▶]** buttons.

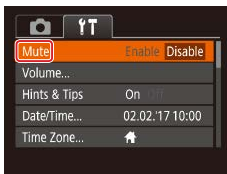

3 Choose a menu item.

- Press the **[▲]**/**[▼]** buttons or turn the **[DIAL]** to choose a menu item.
- For menu items with options not shown, first press the **[MENU]** or **[▶]** button to switch screens, and then either press the **[▲]**/**[▼]** buttons or turn the **[DIAL]** to select the menu item.
- To return to the previous screen, press the **[MENU]** button.



Before Use

Basic Guide

Advanced Guide

Camera Basics

Auto Mode /
Hybrid Auto Mode

Other Shooting Modes

P Mode

Tv, Av, and M Mode

Playback Mode

Wireless Features

Setting Menu

Accessories

Appendix

Index



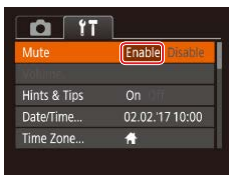

4 Choose an option.

- Press the [◀][▶] buttons to choose an option.

5 Confirm your choice and exit.

- Press the [MENU] button to return to the screen displayed before you pressed the [MENU] button in step 1.



- To undo any accidental setting changes, you can restore the camera's default settings (149).

On-Screen Keyboard

Use the on-screen keyboard to enter information for Face ID (45), Wi-Fi connections (122), and so on. Note that the length and type of information you can enter varies depending on the function you are using.

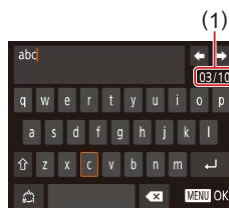

(1) Entering Characters

- Press the [▲][▼][◀][▶] buttons or turn the [DISP] dial to choose a key labeled with a character, and then press the [DISP] button repeatedly to enter the character you want.
- The amount of information you can enter (1) varies depending on the function you are using.



Moving the Cursor

- Choose [◀] or [▶] and press the [DISP] button.

Entering Line Breaks

- Choose [↵] and press the [DISP] button.

Switching Input Modes

- To switch to other kinds of characters (such as numbers or symbols) on this screen, choose [123] and press the [DISP] button.
- To enter uppercase letters, choose [↵] and press the [DISP] button.
- Available input modes vary depending on the function you are using.

Before Use

Basic Guide

Advanced Guide

Camera Basics

Auto Mode / Hybrid Auto Mode

Other Shooting Modes

P Mode

Tv, Av, and M Mode

Playback Mode

Wireless Features

Setting Menu

Accessories

Appendix

Index



Deleting Characters

- Choose [⏪] and press the [⏹] button. The previous character will be deleted.
- Choosing [⏪] and holding down the [⏹] button will delete five characters at a time.

Returning to the Previous Screen

- Press the [MENU] button.

Indicator Display

The indicator on the back of the camera (📖4) lights up or blinks depending on the camera status.

Color	Indicator Status	Camera Status
Green	Blinking	Starting up, recording/reading/transmitting images, shooting long exposures (📖84, 📖85), connected to a computer (📖156), connecting/transmitting via Wi-Fi, or display off (📖26, 📖145, 📖145)
Orange	On	Charging via a compact power adapter



- When the indicator blinks green, do not turn the camera off, open the memory card/battery cover, or shake or hit the camera, which may corrupt images or damage the camera or memory card.

Before Use

Basic Guide

Advanced Guide

Camera Basics

Auto Mode /
Hybrid Auto Mode

Other Shooting Modes

P Mode

Tv, Av, and M Mode

Playback Mode

Wireless Features

Setting Menu

Accessories

Appendix

Index



Clock

You can check the current time.

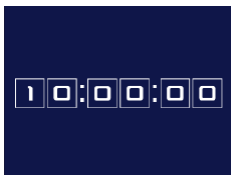

- Press and hold the [⏸] button.
- The current time appears.
- If you hold the camera vertically while using the clock function, it will switch to vertical display. Press the [◀][▶] buttons or turn the [⦿] dial to change the display color.
- Press the [⏸] button again to cancel the clock display.



- When the camera is off, press and hold the [⏸] button, then press the power button to display the clock.

Before Use

Basic Guide

Advanced Guide

Camera Basics

Auto Mode /
Hybrid Auto Mode

Other Shooting Modes

P Mode

Tv, Av, and M Mode

Playback Mode

Wireless Features

Setting Menu

Accessories

Appendix

Index



Auto Mode / Hybrid Auto Mode

Convenient mode for easy shots with greater control over shooting

Shooting with Camera-Determined Settings

For fully automatic selection of the optimal settings for specific scenes, simply let the camera determine the subject and shooting conditions.

Shooting (Smart Auto)

► Still Images ► Movies

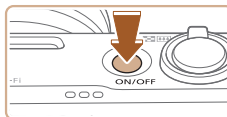

1 Turn the camera on.

- Press the power button.
- The startup screen is displayed.



2 Enter [AUTO] mode.

- Set the mode dial to [AUTO].
- Aim the camera at the subject. The camera will make a slight clicking noise as it determines the scene.
- Icons representing the scene and image stabilization mode are displayed in the upper left of the screen (see 37, 38).
- Frames displayed around any detected subjects indicate that they are in focus.

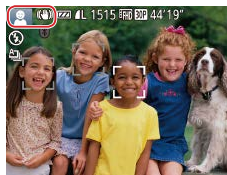

Before Use

Basic Guide

Advanced Guide

Camera Basics

Auto Mode /
Hybrid Auto Mode

Other Shooting Modes

P Mode

Tv, Av, and M Mode

Playback Mode

Wireless Features

Setting Menu

Accessories

Appendix

Index



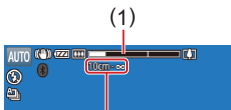
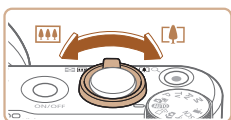

(2)

3 Compose the shot.

- To zoom in and enlarge the subject, move the zoom lever toward [T] (telephoto), and to zoom away from the subject, move it toward [W] (wide angle). (A zoom bar (1) showing the zoom position is displayed, along with the range of focus (2).)
- To zoom in or out quickly, move the zoom lever all the way toward [T] (telephoto) or [W] (wide angle), and to zoom in or out slowly, move it just a little in the desired direction.

4 Shoot.

Shooting Still Images

1) Focus.

- Press the shutter button halfway. The camera beeps twice after focusing, and frames are displayed to indicate image areas in focus.
- Several frames are displayed when multiple areas are in focus.

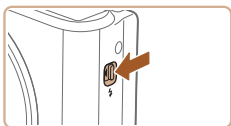
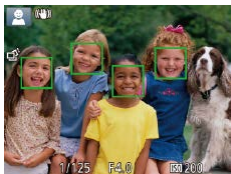
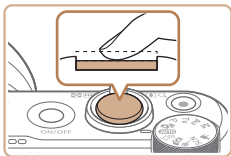

- If [Raise the flash] is displayed, move the [Flash] switch to raise the flash. It will fire when shooting. If you prefer not to use the flash, push it down with your finger, into the camera.

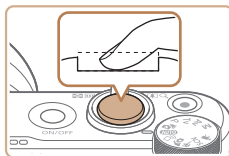

(1)

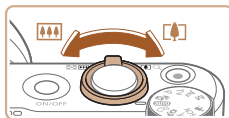
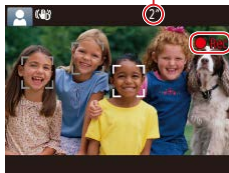

2) Shoot.

- Press the shutter button all the way down.
- As the camera shoots, a shutter sound is played, and in low-light conditions when you have raised the flash, it fires automatically.
- Keep the camera still until the shutter sound ends.
- After displaying your shot, the camera will revert to the shooting screen.

Recording Movies

1) Start recording.

- Press the movie button. The camera beeps once as recording begins, and [Rec] is displayed with the elapsed time (1).
- Black bars are displayed on the top and bottom edges of the screen, and the subject is slightly enlarged. The black bars indicate image areas not recorded.
- Frames displayed around any detected faces indicate that they are in focus.
- Once recording begins, take your finger off the movie button.

2) Resize the subject and recompose the shot as needed.

- To resize the subject, repeat the operations in step 3. However, note that the sound of camera operations will be recorded. Note that movies shot at zoom factors shown in blue will look grainy.
- When you recompose shots, the focus, brightness, and colors will be automatically adjusted.

Before Use
Basic Guide
Advanced Guide
Camera Basics
Auto Mode / Hybrid Auto Mode
Other Shooting Modes
P Mode
Tv, Av, and M Mode
Playback Mode
Wireless Features
Setting Menu
Accessories
Appendix
Index



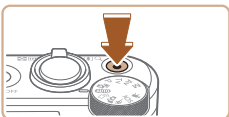

3) Finish recording.

- Press the movie button again to stop recording. The camera beeps twice as recording stops.
- Recording will stop automatically when the memory card becomes full.



- The flash firing during shots indicates that the camera has automatically attempted to ensure optimal colors in the main subject and background (Multi-area White Balance).

Shooting in Hybrid Auto Mode

► Still Images ► Movies

You can make a short movie of the day just by shooting still images. The camera records 2 – 4-second clips of scenes before each shot, which are later combined in a digest movie. Clips recorded in this mode may be included in Story Highlights albums (108).



1 Enter [Hybrid Auto] mode.

- Follow step 2 in “Shooting (Smart Auto)” (33) and choose [Hybrid Auto].

2 Compose the shot.

- Follow steps 3 – 4 in “Shooting (Smart Auto)” (33) to compose the shot and focus.
- For more impressive digest movies, aim the camera at subjects about four seconds before shooting still images.



3 Shoot.

- Follow step 4 in “Shooting (Smart Auto)” (33) to shoot a still image.
- The camera records both a still image and movie clip. The clip, which ends with the still image and a shutter sound, forms a single chapter in the digest movie.



- Battery life is shorter in this mode than in [AUTO] mode, because digest movies are recorded for each shot.
- A digest movie may not be recorded if you shoot a still image immediately after turning the camera on, choosing [Hybrid Auto] mode, or operating the camera in other ways.
- Sounds and vibrations from operating the camera will be recorded in digest movies.



- Digest movie quality is [HD 80P] and cannot be changed.
- Sounds are not played when you press the shutter button halfway or trigger the self-timer (143).
- Digest movies are saved as separate movie files in the following cases even if they were recorded on the same day in [Hybrid Auto] mode.
 - The digest movie file size reaches approximately 4 GB, or the total recording time reaches approximately 16 minutes and 40 seconds.
 - The digest movie is protected (96).
 - Daylight saving time (19) or time zone (144) settings are changed.
 - A new folder is created (148).
- Recorded shutter sounds cannot be modified or erased.
- If you prefer to record digest movies without still images, adjust the setting in advance. Choose MENU (29) > [Camera] tab > [Digest Type] > [No Stills].
- Individual chapters can be edited (107).

Before Use
Basic Guide
Advanced Guide
Camera Basics
Auto Mode / Hybrid Auto Mode
Other Shooting Modes
P Mode
Tv, Av, and M Mode
Playback Mode
Wireless Features
Setting Menu
Accessories
Appendix
Index



Digest Movie Playback

Display a still image shot in [LIVE] mode to play the digest movie created on the same day, or specify the date of the digest movie to play (p.90).

Still Images/Movies



- If the camera makes no operating sounds, it may have been turned on while holding down the [MENU] button. To activate sounds, press the [MENU] button, choose [Mute] on the [INFO] tab, and then press the [LEFT] [RIGHT] buttons to choose [Disable].

Still Images



- A blinking [LIVE] icon warns that images are more likely to be blurred by camera shake. In this case, mount the camera on a tripod or take other measures to keep it still.
- If your shots are dark despite the flash firing, move closer to the subject. For details on the flash range, see "Flash" (p.181).
- The subject may be too close if the camera only beeps once when you press the shutter button halfway. For details on the range of focus (shooting range), see "Lens" (p.181).
- To reduce red-eye and to assist in focusing, the lamp may be lit when shooting in low-light conditions.
- A blinking [LIVE] icon displayed when you attempt to shoot indicates that shooting is not possible until the flash has finished recharging. Shooting can resume as soon as the flash is ready, so either press the shutter button all the way down and wait, or release it and press it again.
- The shutter sound will not be played when the Sleeping and Babies (Sleeping) icons (p.37) are displayed.
- Although you can shoot again before the shooting screen is displayed, your previous shot may determine the focus, brightness, and colors used.



- You can change how long images are displayed after shots (p.55).

Movies



- Keep your fingers away from the microphone (1) while recording movies. Blocking the microphone may prevent audio from being recorded or may cause the recording to sound muffled.

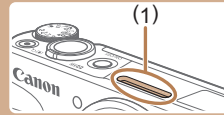

- Avoid touching camera controls other than the movie button when recording movies, because sounds made by the camera will be recorded.
- Once movie recording begins, the image display area changes and subjects are enlarged to allow for correction of significant camera shake. To shoot subjects at the same size shown before shooting, follow the steps in "Recording Movies with Subjects at the Same Size Shown before Shooting" (p.53).



- Audio is recorded in stereo.

Before Use

Basic Guide

Advanced Guide

Camera Basics

Auto Mode /
Hybrid Auto Mode

Other Shooting Modes

P Mode

Tv, Av, and M Mode

Playback Mode

Wireless Features

Setting Menu

Accessories

Appendix

Index



Scene Icons

► Still Images ► Movies

In and [AUTO] modes, shooting scenes determined by the camera are indicated by the icon displayed, and corresponding settings are automatically selected for optimal focusing, subject brightness, and color. Depending on the scene, continuous images may be shot (📖38).

Subject	Background				
	Normal	Backlit	Dark*1	Sunsets	Spotlights
People	*2	*3		—	
Moving People	*3	*3	—	—	—
Shadows on Face	*2	—	—	—	—
Smiling	*3	*3	—	—	—
Sleeping	*2	*3	—	—	—
Babies	*3	*3	—	—	—
Smiling Babies	*3	*3	—	—	—
Sleeping Babies	*2	*3	—	—	—
Moving Children	*3	*3	—	—	—
Other Subjects	*2	*3			
Other Moving Subjects	*3	*3	—	—	—
Other Close-Range Subjects	*2	*3	—	—	

*1 Tripod used.

*2 The background color of icons is light blue when the background is a blue sky, dark blue when the background is dark, and gray for all other backgrounds.

*3 The background color of icons is light blue when the background is a blue sky, and gray for all other backgrounds.

- The background color of , , , , and is dark blue, and the background color of is orange.
- For movies, only People, Other Subjects, and Other Close-Range Subjects icons are displayed.

- In mode, icons are only displayed for People, Shadows on Face, Other Subjects, and Other Close-Range Subjects.
- For self-timer shots, icons are not displayed for the following subjects: moving, smiling, or sleeping people; smiling or sleeping babies; moving children; and other moving subjects.
- Icons are not displayed for smiling or sleeping subjects and moving children in drive modes other than [A] (📖38, 📖44) and when [Hg Lamp Corr.] is set to [On] and scenes are automatically corrected (📖51).
- Backlit icons are not displayed for moving children and smiling people when the flash is set to .
- Icons for babies (including smiling and sleeping babies) and moving children are displayed when [Face ID] is set to [On] and faces of registered babies (less than two years old) or children (2 – 12 years old) are detected (📖46). Confirm beforehand that the date and time are correct (📖19).



- Try shooting in [P] mode (📖70) if the scene icon does not match actual shooting conditions, or if it is not possible to shoot with your expected effect, color, or brightness.

Before Use

Basic Guide

Advanced Guide

Camera Basics

Auto Mode /
Hybrid Auto Mode

Other Shooting Modes

P Mode

Tv, Av, and M Mode

Playback Mode

Wireless Features

Setting Menu



Accessories



Appendix

Index



Continuous Shooting Scenes

If the icon for one of the following scenes (in table's left column) is displayed when you shoot a still image, the camera shoots continuously. If the icon for one of the following scenes (in table's left column) is displayed when you press the shutter button halfway, one of the icons , , or  is displayed to inform you that the camera shoots continuously.

Smiling (including Babies)	 Consecutive images are captured, and the camera analyzes details such as facial expressions to save the image determined to be the best.
Sleeping (including Babies)	 Beautiful shots of sleeping faces, created by combining consecutive shots to reduce camera shake and image noise. The AF-assist beam and the flash will not fire, and the shutter sound will not be played.
Children	 So you don't miss a photo opportunity of children who move around, the camera will capture three consecutive images for each shot.



- In some scenes, expected images may not be saved, and images may not look as expected.
- Focus, image brightness, and color are determined by the first shot.















- When you want to shoot single images only, press the  button, choose  in the menu, and then select .

Image Stabilization Icons



► Still Images ► Movies

Optimal image stabilization for the shooting conditions (Intelligent IS) is automatically applied, and the following icons are displayed.

	Image stabilization for still images (Normal)
	Image stabilization for still images when panning (Panning)*
	Image stabilization for angular camera shake and shift-shake in macro shots (Hybrid IS). For movies,  is displayed and  image stabilization is also applied.
	Image stabilization for movies, reducing strong camera shake, as when recording while walking (Dynamic)
	Image stabilization for slow camera shake, such as when recording movies at telephoto (Powered)
	No image stabilization, because the camera is mounted on a tripod or held still by other means. However, during movie recording,  is displayed, and image stabilization to counteract wind or other sources of vibration is used (Tripod IS).

* Displayed when you pan, following moving subjects with the camera. When you follow subjects moving horizontally, image stabilization only counteracts vertical camera shake, and horizontal stabilization stops. Similarly, when you follow subjects moving vertically, image stabilization only counteracts horizontal camera shake.



- To cancel image stabilization, set [IS Mode] to [Off]  83). In this case, an IS icon is not displayed.
-  is not available in  mode.

Before Use
Basic Guide
Advanced Guide
Camera Basics
Auto Mode / Hybrid Auto Mode
Other Shooting Modes
P Mode
Tv, Av, and M Mode
Playback Mode
Wireless Features
Setting Menu
Accessories
Appendix
Index



On-Screen Frames

► Still Images ► Movies

In [AUTO] mode, a variety of frames are displayed once the camera detects subjects you are aiming the camera at.

- A white frame is displayed around the subject (or person's face) determined by the camera to be the main subject, and gray frames are displayed around other detected faces. Frames follow moving subjects within a certain range to keep them in focus. However, if the camera detects subject movement, only the white frame will remain on the screen.
- When you are pressing the shutter button halfway and the camera detects subject movement, a blue frame is displayed, and the focus and image brightness are constantly adjusted (Servo AF).



- Try shooting in [P] mode (📖70) if no frames are displayed, if frames are not displayed around desired subjects, or if frames are displayed on the background or similar areas.

Common, Convenient Features

Zooming In Closer on Subjects (Digital Zoom)

► Still Images ► Movies

When distant subjects are too far away to enlarge using the optical zoom, use digital zoom for up to about 160x enlargement.

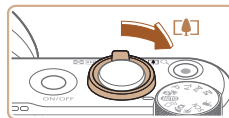

1 Move the zoom lever toward [👤].

- Hold the lever until zooming stops.
- Zooming stops at the largest zoom factor before the image becomes noticeably grainy, which is then indicated on the screen.

2 Move the zoom lever toward [👤] again.

- The camera zooms in even closer on the subject.
- (1) is the current zoom factor.

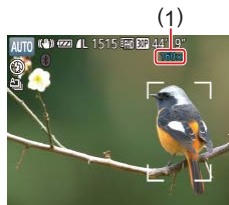

- Moving the zoom lever will display the zoom bar (which indicates the zoom position). The zoom bar is color-coded to indicate the zoom range.
 - White range: optical zoom range where the image will not appear grainy.
 - Yellow range: digital zoom range where the image is not noticeably grainy (ZoomPlus).
 - Blue range: digital zoom range where the image will appear grainy.
- Because the blue range will not be available at some recording pixel settings (📖50), the maximum zoom factor can be achieved by following step 1.

Before Use

Basic Guide

Advanced Guide

Camera Basics

Auto Mode /
Hybrid Auto Mode

Other Shooting Modes

P Mode

Tv, Av, and M Mode

Playback Mode

Wireless Features

Setting Menu

Accessories

Appendix

Index





- To deactivate digital zoom, choose MENU (📖29) > [📷] tab > [Digital Zoom] > [Off].

Easily Reacquiring Subjects after Manual Zooming (Framing Assist – Seek)

▶ Still Images ▶ Movies

If you lose track of a subject while zoomed in, you can find it more easily by temporarily zooming out.

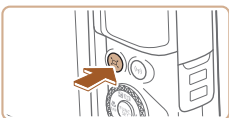

1 Look for the lost subject.

- Press and hold the [📷] button.
- The camera zooms out and displays a white frame around the area shown before you pressed the [📷] button.

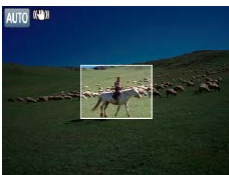

2 Reacquire the subject.

- Aim the camera so that the subject enters the white frame, and then release the [📷] button.
- The previous magnification is now restored, so that the area within the white frame fills the screen again.



- Some shooting information is not displayed while the camera is zoomed out.
- During movie shooting, the white frame is not displayed if you press the [📷] button. Also note that a changed zoom factor and camera operating sounds are recorded.



- If you prefer to shoot at the zoom factor of the screen in step 1, press the shutter button all the way down.
- You can adjust the zoom factor that the camera reverts to when you release the [📷] button by moving the zoom lever to resize the white frame while you hold the [📷] button.
- To adjust the area displayed when the [📷] button is pressed, access MENU (📖29) > [📷] tab > [📷, Display Area], and choose one of the three options.
- The zoom factor cannot be changed with the [📷] button after you press the shutter button all the way down in self-timer mode (📖43).

Auto Zooming in Response to Subject Movement (Auto Zoom)

▶ Still Images ▶ Movies

The camera automatically zooms in and out to keep a detected face (📖77) at a constant size. If the person moves closer, the camera automatically zooms out, and vice versa. This size can also be adjusted, as needed.

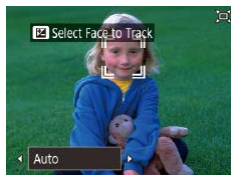

1 Enter [📷] Auto mode.

- Press and release the [📷] button quickly.
- [📷] is displayed.
- A white frame is displayed around the detected face, and the camera zooms in and out to keep the subject on the screen.
- When multiple faces are detected, a white frame is displayed around the main subject's face and up to two gray frames around other faces, as the camera zooms to keep these subjects on the screen.

Before Use
Basic Guide
Advanced Guide
Camera Basics
Auto Mode / Hybrid Auto Mode
Other Shooting Modes
P Mode
Tv, Av, and M Mode
Playback Mode
Wireless Features
Setting Menu
Accessories
Appendix
Index



2 Shoot.

- Auto zooming continues even after you shoot, and the frames are still displayed.
- To cancel auto zooming, press the [ZOOM] button again. [ZOOM] Auto: Off] is displayed.



- A face may not be displayed at a constant size relative to the screen at some zoom factors, or if the person's head is tilted or facing the camera indirectly.
- During movie recording, a changed zoom factor and camera operating sounds are recorded.
- When [ZOOM] Auto is on, some shooting information is not displayed, and some shooting settings cannot be configured.
- Auto zooming to keep multiple subjects on the screen is not performed during movie recording, even if faces are detected.
- Auto zooming is not performed during continuous shooting.



- If multiple faces are detected in step 1, you can switch the main face used for auto zooming by pressing the [SELECT] button.
- When a detected subject moves toward the edge of the screen, the camera zooms out to keep the subject on the screen.
- The zoom factor cannot be changed after you press the shutter button all the way down in self-timer mode (43).
- The camera prioritizes zooming to keep subjects on the screen. For this reason, it may not be possible to maintain a constant face display size, depending on subject movement and shooting conditions.
- When no face is detected, the camera zooms to a certain level and stops zooming until a face is detected.

Adjusting the Constant Face Display Size



- When [ZOOM] Auto is on, press the [ZOOM] buttons to choose the desired option.
- The camera zooms automatically to keep faces at the specified size.

Auto	Auto zoom to prevent subjects from moving off the screen. When multiple faces are detected, the camera zooms to keep these subjects on the screen.
Face	Keep faces large enough to show facial expressions clearly.
Upper Body	Keep faces small enough to show the person's upper body.
Whole Body	Keep faces small enough to show the person's entire body.
Manual	Keep faces at the size specified by moving the zoom lever. Release the zoom lever once the desired size has been obtained.



- The face size can also be adjusted in MENU (29) > [CAMERA] tab > [ZOOM] Auto Settings > [ZOOM] Auto Zoom]. You can choose [Off] to deactivate this feature and use only the feature described in "Easily Reacquiring Subjects with Auto Zooming (Seek Assist)" (42).
- You can zoom in or out with the zoom lever when [Face], [Upper Body], or [Whole Body] is selected, but the original zoom factor will be restored in a few seconds after you release the lever.
- You can clear your specified face size during movie recording by pressing the [ZOOM] button.
- Face sizes cannot be changed during movie recording.

Before Use

Basic Guide

Advanced Guide

Camera Basics

Auto Mode /
Hybrid Auto Mode

Other Shooting Modes

P Mode

Tv, Av, and M Mode

Playback Mode

Wireless Features

Setting Menu

Accessories

Appendix

Index



Easily Reacquiring Subjects with Auto Zooming (Seek Assist)

► Still Images ► Movies

If you lose track of a subject while zoomed in and move the camera to look for it, the camera detects this movement and automatically zooms out, which makes it easier to find the subject.



1 Enter [Z] Auto mode (40).

2 Look for the lost subject.

- When you move the camera to look for the subject, the camera zooms out to help you find it.

3 Reacquire the subject.

- Once you find the subject and stop moving the camera, the camera zooms in again.

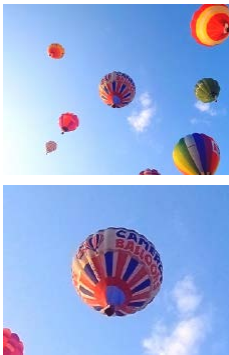

4 Shoot.

- To cancel this mode, press the [Z] button again. [Z] Auto: Off is displayed.



- The camera does not zoom out automatically while [Z] is displayed around a detected face, even if you move the camera.
- When the feature described in “Auto Zooming in Response to Subject Movement (Auto Zoom)” (40) is deactivated, [Z] is displayed around a detected face, and the camera automatically zooms out when moved.
- Zooming is not possible while the shutter button is pressed halfway.
- To deactivate this feature and use only the feature described in “Auto Zooming in Response to Subject Movement (Auto Zoom)” (40), choose MENU (29) > [CAM] tab > [Z] Auto Settings > [Seek Assist] > [Off].

Adding a Date Stamp

► Still Images ► Movies

The camera can add the shooting date to images, in the lower-right corner.

However, note that date stamps cannot be edited or removed, so confirm beforehand that the date and time are correct (19).



1 Configure the setting.

- Press the [MENU] button, choose [Date Stamp] on the [CAM] tab, and then press the [LEFT] buttons to choose [Date & Time] or [Date] (29).

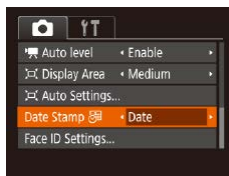

Before Use
Basic Guide
Advanced Guide
Camera Basics
Auto Mode / Hybrid Auto Mode
Other Shooting Modes
P Mode
Tv, Av, and M Mode
Playback Mode
Wireless Features
Setting Menu
Accessories
Appendix
Index

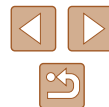



2 Shoot.

- As you take shots, the camera adds the shooting date or time to the lower-right corner of images.
- To restore the original setting, choose [Off] in step 1.



- Date stamps cannot be edited or removed.



- Shots taken without adding a date stamp can be printed with one as follows. However, adding a date stamp this way to images that already have one may cause it to be printed twice.
 - Print using printer functions (158)
 - Use camera DPOF print settings (161) to print
 - Use the software downloaded from the Canon website (155) to print

Using the Self-Timer

► Still Images ► Movies

With the self-timer, you can include yourself in group photos or other timed shots. The camera will shoot about 10 seconds after you press the shutter button.



1 Configure the setting.

- Press the [FUNC SET] button, choose [Off] in the menu, and then choose [On].
- Once the setting is complete, [On] is displayed.

2 Shoot.

- For Still Images: Press the shutter button halfway to focus on the subject, and then press it all the way down.
- For Movies: Press the movie button.
- Once you start the self-timer, the lamp will blink and the camera will play a self-timer sound.
- Two seconds before the shot, the blinking and sound will speed up. (The lamp will remain lit in case the flash fires.)
- To cancel shooting after you have triggered the self-timer, press the [MENU] button.
- To restore the original setting, choose [Off] in step 1.



Before Use
Basic Guide
Advanced Guide
Camera Basics
Auto Mode / Hybrid Auto Mode
Other Shooting Modes
P Mode
Tv, Av, and M Mode
Playback Mode
Wireless Features
Setting Menu
Accessories
Appendix
Index

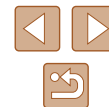

Using the Self-Timer to Avoid Camera Shake

► Still Images ► Movies

This option delays shutter release until about two seconds after you have pressed the shutter button. If the camera is unsteady while you are pressing the shutter button, it will not affect your shot.



- Follow step 1 in “Using the Self-Timer” (📖43) and choose [📷].
- Once the setting is complete, [📷] is displayed.
- Follow step 2 in “Using the Self-Timer” (📖43) to shoot.

Customizing the Self-Timer

► Still Images ► Movies

You can specify the delay (0 – 30 seconds) and number of shots (1 – 10).

1 Choose [📷].

- Following step 1 in “Using the Self-Timer” (📖43), choose [📷] and press the [MENU] button.

2 Configure the setting.

- Press the [▲][▼] buttons to choose the delay time or number of shots.
- Press the [◀][▶] buttons or turn the [🔘] dial to choose a value, and then press the [🔘] button.
- Once the setting is complete, [📷] is displayed.
- Follow step 2 in “Using the Self-Timer” (📖43) to shoot.

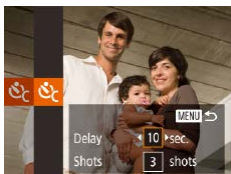

- For movies recorded using the self-timer, recording begins after your specified delay time, but specifying the number of shots has no effect.



- When you specify multiple shots, image brightness and color tone are determined by the first shot. More time is required between shots when the flash fires or when you have specified to take many shots. Shooting will stop automatically when the memory card becomes full.
- When a delay longer than two seconds is specified, two seconds before the shot, the lamp blinking and self-timer sound will speed up. (The lamp will remain lit in case the flash fires.)

Continuous Shooting

► Still Images ► Movies

In [AUTO] mode, hold the shutter button all the way down to shoot continuously.
For details on the continuous shooting speed, see “Shooting” (📖182).



1 Configure the setting.

- Press the [🔘] button, choose [A] in the menu, and then choose [📷] (📖28).
- Once the setting is complete, [📷] is displayed.

2 Shoot.

- Hold the shutter button all the way down to shoot continuously.

Before Use
Basic Guide
Advanced Guide
Camera Basics
Auto Mode / Hybrid Auto Mode
Other Shooting Modes
P Mode
Tv, Av, and M Mode
Playback Mode
Wireless Features
Setting Menu
Accessories
Appendix
Index





- During continuous shooting, the focus, exposure, and colors are locked at the position/level determined when you pressed the shutter button halfway.
- Cannot be used with the self-timer (📖43).
- Shooting may stop momentarily or continuous shooting may slow down depending on shooting conditions, camera settings, and the zoom position.
- As more shots are taken, shooting may slow down.
- Shooting may slow down if the flash fires.
- Multi-area White Balance (📖33) is not available. Similarly, [Hg Lamp Corr.] (📖51) is set to [Off] and cannot be changed.

Image Display during Playback

Each set of images shot continuously is managed as a single group, and only the first image in that group will be displayed. To indicate that the image is part of a group, [SET] (📖) is displayed in the upper left of the screen.



- If you erase a grouped image (📖98), all images in the group are also erased. Be careful when erasing images.



- Grouped images can be played back individually (📖92) and ungrouped (📖92).
- Protecting (📖96) a grouped image will protect all images in the group.
- Grouped images can be viewed individually when played back using Image Search (📖91) or Smart Shuffle (📖95). In this case, images are temporarily ungrouped.
- The following actions are not available for grouped images: editing Face ID information (📖93), magnifying (📖94), tagging as favorites (📖101), editing (📖102), printing (📖157), setting up individual image printing (📖161), or adding to a photobook (📖163). To do these things, either view grouped images individually (📖92) or cancel grouping (📖92) first.

Using Face ID

If you register a person ahead of time, the camera will detect that person's face, and prioritize focus, brightness, and color for that person when shooting. In [AUTO] mode, the camera can detect babies and children based on registered birthdays and optimize settings for them when shooting.

This function is also useful when searching for a specific registered person among a large number of images (📖91).

Registering people in advance also makes it easier to add them when creating Story Highlights albums (📖108).

Personal Information

- Information such as images of a face (face info) registered with Face ID, and personal information (name, birthday) will be saved on the camera. Additionally, when registered people are detected, their names will be recorded in still images. When using the Face ID function, be careful when sharing the camera or images with others, and when posting images online where many others can view them.
- When disposing of a camera or transferring it to another person after using Face ID, be sure to erase all information (registered faces, names, and birthdays) from the camera (📖49).

Before Use

Basic Guide

Advanced Guide

Camera Basics

Auto Mode /
Hybrid Auto Mode

Other Shooting Modes

P Mode

Tv, Av, and M Mode

Playback Mode

Wireless Features

Setting Menu

Accessories

Appendix

Index



Registering Face ID Information

You can register information (face info, names, and birthdays) for up to 12 people to use with Face ID.

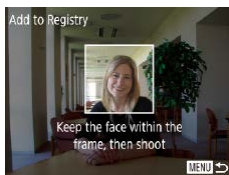
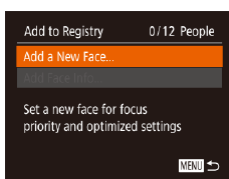
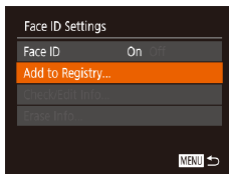
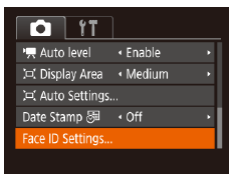

1 Access the setting screen.

- Press the [MENU] button, choose [Face ID Settings] on the [CAMERA] tab, and then press the [OK] button (p. 29).

- Press the [▲][▼] buttons or turn the [DIAL] dial to choose [Add to Registry], and then press the [OK] button.

- Press the [▲][▼] buttons or turn the [DIAL] dial to choose [Add a New Face], and then press the [OK] button.

2 Register face information.

- Aim the camera so that the face of the person you want to register is inside the gray frame at the center of the screen.
- A white frame on the person's face indicates that the face is recognized. Make sure a white frame is displayed on the face, and then shoot.
- If the face is not recognized, you cannot register face information.

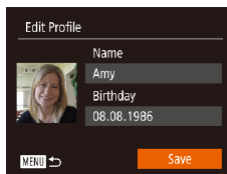
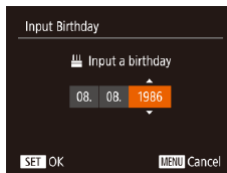
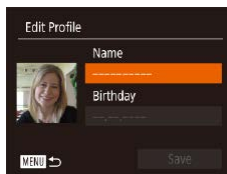
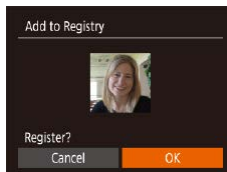

- After [Register?] is displayed, press the [◀][▶] buttons or turn the [DIAL] dial to choose [OK], and then press the [OK] button.

- The [Edit Profile] screen is displayed.

3 Register the person's name and birthday.

- Press the [OK] button to access the keyboard, and then enter the name (p. 30).

- To register a birthday, on the [Edit Profile] screen, choose [Birthday] (either press the [▲][▼] buttons or turn the [DIAL] dial), and then press the [OK] button.

- Press the [◀][▶] buttons to choose an option.

- Press the [▲][▼] buttons or turn the [DIAL] dial to specify the date.

- When finished, press the [OK] button.

4 Save the settings.

- Press the [▲][▼] buttons or turn the [DIAL] dial to choose [Save], and then press the [OK] button.

- After a message is displayed, press the [◀][▶] buttons or turn the [DIAL] dial to choose [Yes], and then press the [OK] button.

Before Use

Basic Guide

Advanced Guide

Camera Basics

Auto Mode / Hybrid Auto Mode

Other Shooting Modes

P Mode

Tv, Av, and M Mode

Playback Mode

Wireless Features

Setting Menu

Accessories

Appendix

Index



5 Continue registering face information.

- To register up to 4 more points of face information (expressions or angles), repeat step 2.
- Registered faces are more easily recognized if you add a variety of face information. In addition to a head-on angle, add a slight side angle, a shot when smiling, and shots inside and outside.



- The flash will not fire when following step 2.
- If you do not register a birthday in step 3, Babies or Children icons (👶👦) will not be displayed in [AUTO] mode.



- You can overwrite registered face info, and add face info later if you have not filled all 5 face info slots (📖46).

Shooting

If you register a person ahead of time, the camera will prioritize that person as the main subject, and optimize focus, brightness, and color for that person when shooting.



- When you point the camera toward people, the names of up to 3 registered people will be displayed when they are detected.
- Shoot.
- Displayed names will be recorded in still images. The names of detected people (maximum total of 5) will be recorded, even if the names are not displayed.



- People other than those registered may be mistakenly detected as the registered person if they share similar facial features.



- Registered people may not be correctly detected if the captured image or scene differs drastically from the registered face information.
- If a registered face is not detected, or not easily detected, overwrite registered information with new face info. Registering face info right before shooting will allow for easier detection of registered faces.
- If a person is mistakenly detected as another person and you continue shooting, you can edit or erase the name recorded in the image during playback (📖93).
- Because faces of babies and children change quickly as they grow, you should update their face info regularly (📖46).
- If you don't want names to be recorded in still images, choose [Face ID Settings] on the [📷] tab, choose [Face ID], and then choose [Off].
- You can check names recorded in images in the playback screen (simple information display) (📖88).
- In [📷] mode, names are not displayed on the shooting screen, but they will be recorded in still images.
- Names recorded in continuous shooting (📖44, 📖80) continue to be recorded in the same position as the first shot, even if subjects move.

Checking and Editing Registered Information

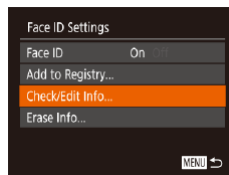

1 Access the [Check/Edit Info] screen.

- Following step 1 in “Registering Face ID Information” (📖46), choose [Check/Edit Info] and press the [📷] button.

Before Use
Basic Guide
Advanced Guide
Camera Basics
Auto Mode / Hybrid Auto Mode
Other Shooting Modes
P Mode
Tv, Av, and M Mode
Playback Mode
Wireless Features
Setting Menu
Accessories
Appendix
Index

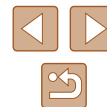

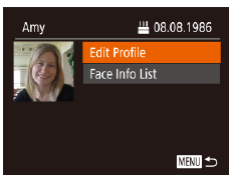

2 Choose a person to check or edit their information.

- Press the [▲][▼][◀][▶] buttons or turn the [🔍] dial to choose the person whose information you want to check or edit, and then press the [👤] button.

3 Check or edit the information as needed.

- To check a name or birthday, choose [Edit Profile] (either press the [▲][▼] buttons or turn the [🔍] dial), and then press the [👤] button. On the screen displayed, you can edit the name or birthday as described in step 3 of “Registering Face ID Information” (📖46).
- To check face information, choose [Face Info List] (either press the [▲][▼] buttons or turn the [🔍] dial), and then press the [👤] button. To erase face information, press the [👤] button on the screen displayed, choose face information to erase by pressing the [▲][▼][◀][▶] buttons or turning the [🔍] dial, and then press the [👤] button. After [Erase?] is displayed, choose [OK] (either press the [◀][▶] buttons or turn the [🔍] dial), and then press the [👤] button.



- Even if you change names in [Edit Profile], the names recorded in previously shot images will remain the same.

Overwriting and Adding Face Information

You can overwrite existing face information with new face info. You should update face information regularly, especially with babies and children, as their faces change quickly as they grow.

You can also add face information when all 5 face info slots have not been filled.

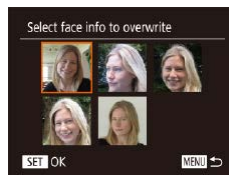
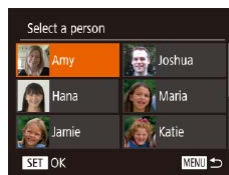
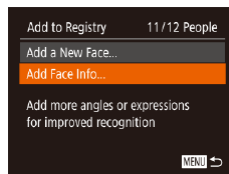

1 Access the [Add Face Info] screen.

- Following step 1 in “Registering Face ID Information” (📖46), choose [Add Face Info] and press the [👤] button.

2 Choose a person to overwrite their face info.

- Press the [▲][▼][◀][▶] buttons or turn the [🔍] dial to choose the name of the person whose face info you want to overwrite, and then press the [👤] button.
- If five items of face info have already been registered, a message will be displayed. Choose [OK] (either press the [◀][▶] buttons or turn the [🔍] dial), and then press the [👤] button.
- If less than five items of face info are registered, go to step 4 to add face information.

3 Choose the face info to overwrite.

- Press the [▲][▼][◀][▶] buttons or turn the [🔍] dial to choose the face info to overwrite, and then press the [👤] button.

Before Use
Basic Guide
Advanced Guide
Camera Basics
Auto Mode / Hybrid Auto Mode
Other Shooting Modes
P Mode
Tv, Av, and M Mode
Playback Mode
Wireless Features
Setting Menu
Accessories
Appendix
Index





4 Register face information.

- Follow step 2 in “Registering Face ID Information” (📖46) to shoot, and then register the new face information.
- Registered faces are more easily recognized if you add a variety of face information. In addition to a head-on angle, add a slight side angle, a shot when smiling, and shots inside and outside.



- You cannot add face information if all 5 information slots are filled. Follow the steps above to overwrite face information.
- You can follow the above steps to register new face info when there is at least one slot open; however, you cannot overwrite any face information. Instead of overwriting face info, first erase unwanted existing info (📖47), and then register new face information (📖46) as needed.

Erasing Registered Information

You can erase information (face info, names, and birthdays) registered to Face ID. However, names recorded in previously shot images will not be erased.

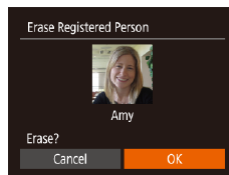
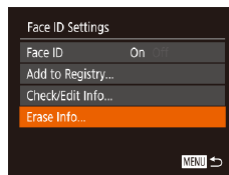

1 Access the [Erase Info] screen.

- Follow step 1 in “Registering Face ID Information” (📖46) and choose [Erase Info].

2 Choose a person to erase their information.

- Press the [▲][▼][◀][▶] buttons or turn the [🔘] dial to choose the name of the person to erase, and then press the [🔘] button.
- After [Erase?] is displayed, press the [◀][▶] buttons or turn the [🔘] dial to choose [OK], and then press the [🔘] button.



- If you erase a registered person's info, you will not be able to display their name (📖90), overwrite their info (📖93), or search for images that include them (📖91).



- You can also erase names in image information (📖93).

Before Use

Basic Guide

Advanced Guide

Camera Basics

Auto Mode /
Hybrid Auto Mode

Other Shooting Modes

P Mode

Tv, Av, and M Mode

Playback Mode

Wireless Features

Setting Menu

Accessories

Appendix

Index



Image Customization Features

Changing the Aspect Ratio

► Still Images ► Movies

Change the image aspect ratio (ratio of width to height) as follows.



- Press the [FUNC SET] button, choose [4:3] in the menu, and choose the desired option (182).
- Once the setting is complete, the screen aspect ratio will be updated.
- To restore the original setting, repeat this process but choose [4:3].



16:9	Used for display on widescreen HDTVs or similar display devices.
3:2	Same aspect ratio as 35mm film, used for printing images at 5 x 7-inch or postcard sizes.
4:3	Native aspect ratio of the camera screen. Used for display on standard-definition televisions or similar display devices. Also used for printing images at 3.5 x 5-inch or A-series sizes.
1:1	Square aspect ratio.



• Not available in [A] mode.

Changing the Number of Recording Pixels (Image Size)

► Still Images ► Movies

Choose the image's number of recording pixels from 4 levels, as follows. For guidelines on how many shots at each recording pixel setting can fit on a memory card, see "Recording" (182).



- Press the [FUNC SET] button, choose [L] in the menu, and choose the desired option (182).
- The option you configured is now displayed.
- To restore the original setting, repeat this process but choose [L].

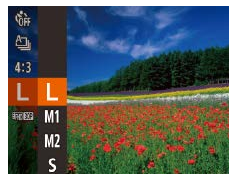

Guidelines for Choosing Recording Pixel Setting Based on Paper Size (for 4:3 Images)

L	A2 (16.5 x 23.4 in.)
M1	A3 – A5 (11.7 x 16.5 – 5.8 x 8.3 in.)
M2	3.5 x 5 in., 5 x 7 in., Postcard
S	For e-mailing and similar purposes



• Not available in [A] mode.

Before Use

Basic Guide

Advanced Guide

Camera Basics

Auto Mode / Hybrid Auto Mode

Other Shooting Modes

P Mode

Tv, Av, and M Mode

Playback Mode

Wireless Features

Setting Menu

Accessories

Appendix

Index



Correcting Greenish Image Areas from Mercury Lamps

► Still Images ► Movies

In [AUTO] mode, subjects or background in shots of evening scenes illuminated by mercury lamps may appear to have a greenish tinge. This greenish tinge can be corrected automatically when shooting, using Multi-area White Balance.

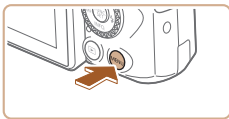

- Press the [MENU] button, choose [Hg Lamp Corr.] on the [CAMERA] tab, and then choose [On] (182).
- Once the setting is complete, [INFO] is displayed.
- To restore the original setting, repeat this process but choose [Off].

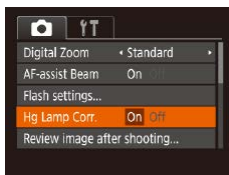

- After you are finished shooting under mercury lamps, you should set [Hg Lamp Corr.] back to [Off]. Otherwise, green hues not caused by mercury lamps may be corrected by mistake.



- Try taking some test shots first to make sure you obtain the desired results.
- In continuous shooting (144), this setting is set to [Off] and cannot be changed.

Changing Movie Image Quality

► Still Images ► Movies

Three image quality settings are available. For guidelines on the total recording time for movies at each level of image quality that will fit on a memory card, see "Recording" (182).

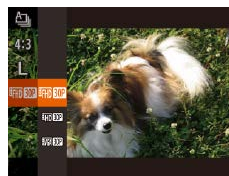

- Press the [MENU] button, choose [FHD 30P] in the menu, and choose the desired option (128).
- The option you configured is now displayed.
- To restore the original setting, repeat this process but choose [FHD 30P].

Image Quality	Number of Recording Pixels	Frame Rate	Details
FHD 30P	1920 x 1080	30 fps	For shooting in Full HD.
HD 30P	1280 x 720	30 fps	For shooting in HD.
VGA 30P	640 x 480	30 fps	For shooting in standard definition.



- In [FHD 30P] and [HD 30P] modes, black bars displayed on the top and bottom edges of the screen indicate image areas not recorded.
- In [FHD 60P] mode, [FHD 60P] is also available, offering smoother motion (167).

Before Use

Basic Guide

Advanced Guide

Camera Basics

Auto Mode / Hybrid Auto Mode

Other Shooting Modes

P Mode

Tv, Av, and M Mode

Playback Mode

Wireless Features

Setting Menu

Accessories

Appendix

Index



Helpful Shooting Features

Displaying Grid Lines

► Still Images ► Movies

Grid lines can be displayed on the screen for vertical and horizontal reference while shooting.

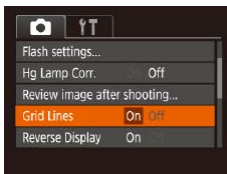
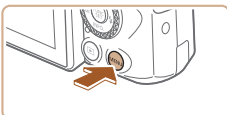

- Press the [MENU] button, choose [Grid Lines] on the [CAMERA] tab, and then choose [On] (📖29).
- Once the setting is complete, grid lines are displayed on the screen.
- To restore the original setting, repeat this process but choose [Off].



- Grid lines are not recorded in your shots.

Deactivating Auto Level

► Still Images ► Movies

Auto leveling keeps movies straight. To cancel this feature, choose [Disable].

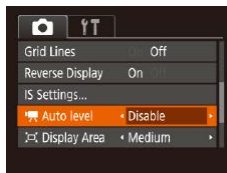

- Press the [MENU] button, choose [Auto level] on the [CAMERA] tab, and then choose [Disable] (📖29).



- Once recording begins, the display area narrows, and subjects are enlarged (📖53).

Before Use

Basic Guide

Advanced Guide

Camera Basics

Auto Mode /
Hybrid Auto Mode

Other Shooting Modes

P Mode

Tv, Av, and M Mode

Playback Mode

Wireless Features

Setting Menu

Accessories

Appendix

Index



Changing the IS Mode Settings

▶ Still Images ▶ Movies

Deactivating Image Stabilization

When the camera is held still (as when shooting from a tripod), you should set image stabilization to [Off] to deactivate it.

1 Access the setting screen.

- Press the [MENU] button, choose [IS Settings] on the [CAMERA] tab, and then press the [OK] button (📖29).

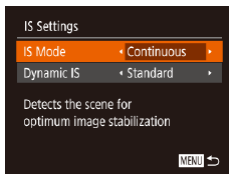

2 Configure the setting.

- Press the [▲][▼] buttons or turn the [DISP] dial to choose [IS Mode], and then choose [Off] by pressing the [◀][▶] buttons.

Continuous	Optimal image stabilization for the shooting conditions is automatically applied (Intelligent IS) (📖38).
Off	Deactivates image stabilization.

Recording Movies with Subjects at the Same Size Shown before Shooting

▶ Still Images ▶ Movies

Normally, once movie recording begins, the image display area changes and subjects are enlarged to allow for image straightening and correction of significant camera shake.

To record movies with subjects at the same size shown before shooting, you can reduce image stabilization and cancel Auto level.

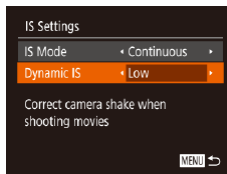

- Set [Auto level] to [Disable] as described in “Deactivating Auto Level” (📖52).
- Follow step 1 in “Deactivating Image Stabilization” (📖53) to access the [IS Settings] screen.
- Choose [Dynamic IS], and then choose [Low] (📖29).



- You can also set [IS Mode] to [Off], so that subjects are recorded at the same size shown before shooting.
- [Dynamic IS] is not available when [IS Mode] is set to [Off] (📖53).
- Only [Standard] is available when the movie quality is set to [VGA 30P].

Before Use

Basic Guide

Advanced Guide

Camera Basics

Auto Mode / Hybrid Auto Mode

Other Shooting Modes

P Mode

Tv, Av, and M Mode

Playback Mode

Wireless Features

Setting Menu

Accessories

Appendix

Index



Customizing Camera Operation

Customize shooting functions on the [CAMERA] tab of the menu screen as follows.

For instructions on menu functions, see “Using the Menu Screen” (p.29).

Preventing the AF-Assist Beam from Firing

▶ Still Images ▶ Movies

You can deactivate the lamp that normally lights up to help you focus when you press the shutter button halfway in low-light conditions.

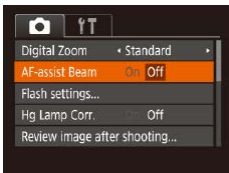

- Press the [MENU] button, choose [AF-assist Beam] on the [CAMERA] tab, and then choose [Off] (p.29).
- To restore the original setting, repeat this process but choose [On].

Preventing the Red-Eye Reduction Lamp from Lighting Up

▶ Still Images ▶ Movies

You can deactivate the red-eye reduction lamp that lights up to reduce red-eye when the flash is used in low-light shots.

1 Access the [Flash settings] screen.

- Press the [MENU] button, choose [Flash settings] on the [CAMERA] tab, and then press the [CAMERA] button (p.29).

2 Configure the setting.

- Choose [Off] (p.29).
- To restore the original setting, repeat this process but choose [On].

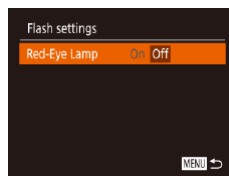

Before Use

Basic Guide

Advanced Guide

Camera Basics

Auto Mode /
Hybrid Auto Mode

Other Shooting Modes

P Mode

Tv, Av, and M Mode

Playback Mode

Wireless Features

Setting Menu

Accessories

Appendix

Index

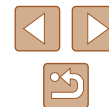

Changing the Image Display Style after Shots

► Still Images ► Movies

You can change how long images are displayed and what information is displayed immediately after shooting.

Changing the Image Display Period after Shots

1 Access the [Review image after shooting] screen.

- Press the [MENU] button, choose [Review image after shooting] on the [CAMERA] tab, and then press the [INFO] button (129).

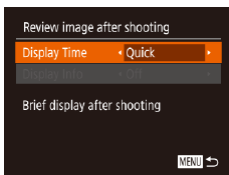

2 Configure the setting.

- Choose [Display Time] and press the [LEFT][RIGHT] buttons to choose the desired option.
- To restore the original setting, repeat this process but choose [Quick].



Quick	Displays images only until you can shoot again.
2 sec., 4 sec., 8 sec.	Displays images for the specified time. Even while the shot is displayed, you can take another shot by pressing the shutter button halfway again.
Hold	Displays images until you press the shutter button halfway.
Off	No image display after shots.

Changing the Screen Displayed after Shots

Change the way images are displayed after shots as follows.

1 Set [Display Time] to [2 sec.], [4 sec.], [8 sec.], or [Hold] (155).

2 Configure the setting.

- Press the [UP][DOWN] buttons or turn the [INFO] dial to choose [Display Info]. Press the [LEFT][RIGHT] buttons to choose the desired option.
- To restore the original setting, repeat this process but choose [Off].

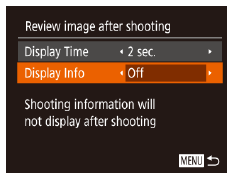

Off	Displays only the image.
Detailed	Displays shooting details (171).



- When [Display Time] (155) is set to [Off] or [Quick], [Display Info] is set to [Off] and cannot be changed.
- By pressing the [DOWN] button while an image is displayed after shooting, you can switch the display information. Note that the settings of [Display Info] are not changed. You can also erase images by pressing the [ERASE] button, or protect (196) or tag images as favorites (101) by pressing the [INFO] button.

Before Use

Basic Guide

Advanced Guide

Camera Basics

Auto Mode /
Hybrid Auto Mode

Other Shooting Modes

P Mode

Tv, Av, and M Mode

Playback Mode

Wireless Features

Setting Menu

Accessories

Appendix

Index



Other Shooting Modes

Shoot more effectively in various scenes, and take shots enhanced with unique image effects or captured using special functions



Applying Effects Automatically (Creative Shot)

► Still Images ► Movies

Enjoying a Variety of Images from Each Shot

The camera determines the subject and shooting conditions, automatically applying special effects and recomposing the shot to emphasize the subject. Six still images are recorded for each shot. You can capture multiple still images with effects using camera-determined settings.



1 Enter [Creative Shot] mode.

- Set the mode dial to [Creative Shot].

2 Shoot.

- Press the shutter button all the way down. As you shoot, the shutter sound is played three times.
- After the six images are displayed in succession, they are displayed simultaneously for about two seconds.
- To keep the images displayed until you press the shutter button halfway, press the [OK] button. You can choose an image for full-screen display by pressing the [▲][▼][◀][▶] buttons or turning the [Mode] dial, and then press the [OK] button.
- To return to the original display, press the [MENU] button.

Before Use

Basic Guide

Advanced Guide

Camera Basics

Auto Mode /
Hybrid Auto Mode

Other Shooting Modes

P Mode

Tv, Av, and M Mode

Playback Mode

Wireless Features

Setting Menu

Accessories

Appendix

Index





- Shooting will take some time when the flash fires, but hold the camera steady until the shutter sound is played three times.
- The six images are managed together as a group (📖92).
- Simultaneous display of the six images as shown in step 2 is only available immediately after you shoot.

Choosing Effects

You can choose effects for images captured in [📷] mode.



- After choosing [📷] mode, press the [▼] button.
- Press the [◀][▶] buttons or turn the [🔘] dial to choose the effect, and then press the [OK] button.

📷 Auto	All effects
🕒 Retro	Images resemble old photos
🎨 Monochrome	Images are generated in one color
🔍 Special	Bold, distinctive-looking images
🌿 Natural	Subdued, natural-looking images

Recording Movies with a Variety of Effects

Let the camera determine subjects and shooting conditions when you record movies, and filters and effects such as playback in slow or fast motion will be added automatically. Once you have recorded a few movies, up to four are automatically combined to create a Creative Shot movie of 15 – 25 seconds. Note that sound is not recorded in this mode.

1 Enter [📷] mode.

- Set the mode dial to [📷].

2 Record the first movie.

- Press the movie button. Recording begins, and a bar is displayed to indicate the elapsed time.
- Recording stops automatically in 3 – 6 seconds.

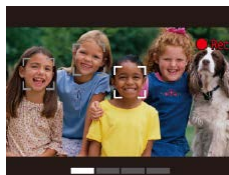

3 Record the second to fourth movies.

- Repeat step 2 three times to record four movies.



- Even if you do not record four movies that day, a Creative Shot movie will be saved as a separate file once the date changes.



- Effects are generally applied consistently to movies 1 – 4, but you can also change the effect in each movie (📖57).
- Individual chapters can be edited (📖107).

Creative Shot Movie Playback

You can choose and play back Creative Shot movies recorded in [📷] mode (📖89).

Before Use

Basic Guide

Advanced Guide

Camera Basics

Auto Mode /
Hybrid Auto Mode

Other Shooting Modes

P Mode

Tv, Av, and M Mode

Playback Mode

Wireless Features

Setting Menu

Accessories

Appendix

Index



Shooting Yourself under Optimal Settings (Self Portrait)

► Still Images ► Movies

For self-portraits, customizable image processing includes skin smoothing as well as brightness and background adjustment to make yourself stand out.



1 Enter [Self Portrait] mode.

- Set the mode dial to [Self Portrait].

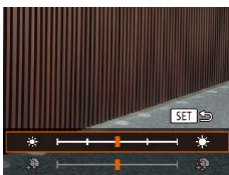

2 Configure the setting.

- Press the [Down Arrow] button to access the setting screen for smooth skin and brightness. Press the [Up Arrow][Down Arrow] buttons to choose a setting item, and then press the [Left Arrow][Right Arrow] buttons or turn the [Dial] to adjust the value as you watch the screen.
- Background defocus can also be disabled. After you choose [Self Portrait] in step 1, press the [Left Arrow] button.

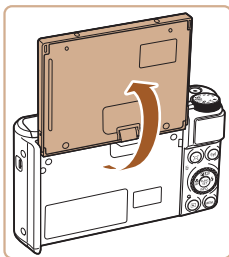

3 Open the screen.

- Open the screen as shown.

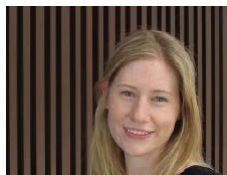

4 Shoot.

- Hold the camera steady as you shoot. When you press the shutter button all the way down with background defocus set to [Auto], the camera shoots twice and processes the images.

Smooth skin effect	Choose from three levels of skin smoothing. Skin smoothing is optimized for the main subject's face.
Brightness	Choose from five levels of brightness.
Background Defocus	Defocus the background.



- Areas other than people's skin may be modified, depending on the shooting conditions.
- Try taking some test shots first to make sure you obtain the desired results.



- In [Flash] mode, background defocusing is set to [Off] and cannot be changed.
- The time left before shooting is shown on the top of the screen when you activate the self-timer by selecting [Self-Timer], or by selecting [Self-Timer] and setting the time to 3 seconds or more.

- Before Use
- Basic Guide
- Advanced Guide
 - Camera Basics
 - Auto Mode / Hybrid Auto Mode
 - Other Shooting Modes
 - P Mode
 - Tv, Av, and M Mode
 - Playback Mode
 - Wireless Features
 - Setting Menu
 - Accessories
 - Appendix
- Index

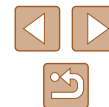

Moving Subjects (Sports)

► Still Images ► Movies

Shoot continuously as the camera focuses on moving subjects.



1 Enter [S&L] mode.

- Set the mode dial to [S&L].



2 Focus.

- While you are pressing the shutter button halfway, the camera will continue to adjust focus and image brightness where the blue frame is displayed.

3 Shoot.

- Hold the shutter button all the way down to shoot continuously.



- In [S&L] mode, shots may look grainy because the ISO speed (72) is increased to suit the shooting conditions.
- For details on the shooting range in [S&L] mode, see “Lens” (181).
- There may be a delay after continuous shooting before you can shoot again. Note that some types of memory cards may delay your next shot even longer.
- Shooting may slow down depending on shooting conditions, camera settings, and the zoom position.
- Continuous shooting is not available in [□] Auto mode (40).

Specific Scenes

Choose a mode matching the shooting scene, and the camera will automatically configure the settings for optimal shots.



1 Enter [SCN] mode.

- Set the mode dial to [SCN].

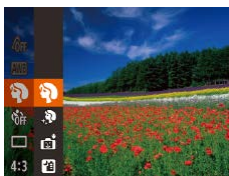

2 Choose a shooting mode.

- Press the [C] button, choose [S&L] in the menu, and then choose a shooting mode (28).



3 Shoot.

Shooting Portraits (Portrait)

► Still Images ► Movies

- Take shots of people with a softening effect.



Shooting Evening Scenes without Using a Tripod (Handheld Night Scene)

► Still Images ► Movies

- Beautiful shots of evening scenes or portraits with evening scenery in the background, without the need to hold the camera very still (as with a tripod).
- A single image is created by combining consecutive shots, reducing camera shake and image noise.

Before Use

Basic Guide

Advanced Guide

Camera Basics

Auto Mode /
Hybrid Auto Mode

Other Shooting Modes

P Mode

Tv, Av, and M Mode

Playback Mode

Wireless Features

Setting Menu

Accessories

Appendix

Index





☾ Shooting under Low Light (Low Light)

▶ Still Images ▶ Movies

- Shoot with minimal camera and subject shake even in low-light conditions.



🎆 Shooting Fireworks (Fireworks)

▶ Still Images ▶ Movies

- Vivid shots of fireworks.



- Subjects appear larger in [P] mode compared to other modes.
- In [P] mode, shots may look grainy because the ISO speed (p.72) is increased to suit the shooting conditions.
- Because the camera will shoot continuously in [P] mode, hold it steady while shooting.
- In [P] mode, excessive motion blur or certain shooting conditions may prevent you from obtaining the desired results.
- In [P] mode, mount the camera on a tripod or take other measures to keep it still and prevent camera shake. Additionally, you should set [IS Mode] to [Off] when using a tripod or other means to secure the camera (p.83).



- When you use a tripod for evening scenes, shooting in [AUTO] mode instead of [P] mode will give better results (p.33).
- [P] mode recording pixel setting is [M] (2592 x 1944) and cannot be changed.
- In [P] mode, although no frames are displayed when you press the shutter button halfway, optimal focus is still determined.

Applying Special Effects

Add a variety of effects to images when shooting.



1 Choose a shooting mode.

- Follow steps 1 – 2 in “Specific Scenes” (p.59) to choose a shooting mode.

2 Shoot.

🌈 Shooting in Vivid Colors (Super Vivid)

▶ Still Images ▶ Movies



- Shots in rich, vivid colors.



🎨 Posterized Shots (Poster Effect)

▶ Still Images ▶ Movies

- Shots that resemble an old poster or illustration.



- In [P] and [P] modes, try taking some test shots first, to make sure you obtain the desired results.

Before Use

Basic Guide

Advanced Guide

Camera Basics

Auto Mode / Hybrid Auto Mode

Other Shooting Modes

P Mode

Tv, Av, and M Mode

Playback Mode

Wireless Features

Setting Menu

Accessories

Appendix

Index



Shooting with a Skin Smoothing Effect (Smooth Skin)

▶ Still Images ▶ Movies

Processes images to make skin look smoother.

1 Choose [👤].

- Follow steps 1 – 2 in “Specific Scenes” (📖59) and choose [👤].

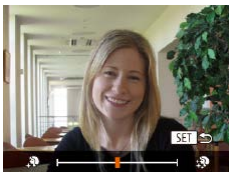

2 Choose an effect level.

- Press the [▼] button, choose an effect level (either press the [◀][▶] buttons or turn the [👤] dial), and then press the [👤] button.
- A preview is shown of how your shot will look with the effect applied.

3 Shoot.



- Areas other than people's skin may be modified, depending on the shooting conditions.
- Try taking some test shots first to make sure you obtain the desired results.

Shooting with a Fish-Eye Lens Effect (Fish-Eye Effect)

▶ Still Images ▶ Movies

Shoot with the distorting effect of a fish-eye lens.

1 Choose [👤].

- Follow steps 1 – 2 in “Specific Scenes” (📖59) and choose [👤].



2 Choose an effect level.

- Press the [▼] button, choose an effect level (either press the [◀][▶] buttons or turn the [👤] dial), and then press the [👤] button.
- A preview is shown of how your shot will look with the effect applied.

3 Shoot.



- Try taking some test shots first to make sure you obtain the desired results.

Before Use

Basic Guide

Advanced Guide

Camera Basics

Auto Mode /
Hybrid Auto Mode

Other Shooting Modes

P Mode

Tv, Av, and M Mode

Playback Mode

Wireless Features

Setting Menu

Accessories

Appendix

Index





Shots Resembling Miniature Models (Miniature Effect)

► Still Images ► Movies



Creates the effect of a miniature model, by blurring image areas above and below your selected area. You can also make movies that look like scenes in miniature models by choosing the playback speed before the movie is recorded. People and objects in the scene will move quickly during playback. Note that sound is not recorded.

1 Choose [].

- Follow steps 1 – 2 in “Specific Scenes” (59) and choose [].
- A white frame is displayed, indicating the image area that will not be blurred.





2 Choose the area to keep in focus.

- Press the [] button.
- Move the zoom lever to resize the frame, and press the [][] buttons to move it.



3 For movies, choose the movie playback speed.

- Press the [MENU] button, and then choose the speed by pressing the [][] buttons or turning the [] dial.

4 Return to the shooting screen and shoot.

- Press the [MENU] button to return to the shooting screen, and then shoot.

Playback Speed and Estimated Playback Time (for One-Minute Clips)









Speed	Playback Time
5x	Approx. 12 sec.
10x	Approx. 6 sec.
20x	Approx. 3 sec.

Movies are played back at 30 fps.



- The zoom is not available when shooting movies. Be sure to set the zoom before shooting.
- Try taking some test shots first to make sure you obtain the desired results.



- To switch the orientation of the frame (from horizontal to vertical or vice-versa), press the [][] buttons in step 2. You can move the frame in vertical orientation by pressing the [][] buttons.
- Holding the camera vertically will change the orientation of the frame.
- Movie image quality is [] at an aspect ratio of [4:3] and [] at an aspect ratio of [16:9] (50). These quality settings cannot be changed.
- The zoom factor cannot be changed with the [] button on the screens in steps 2 and 3, or while shooting movies.

Before Use

Basic Guide

Advanced Guide

Camera Basics

Auto Mode /
Hybrid Auto Mode

Other Shooting Modes

P Mode

Tv, Av, and M Mode

Playback Mode

Wireless Features

Setting Menu

Accessories

Appendix

Index



Shooting with a Toy Camera Effect (Toy Camera Effect)

▶ Still Images ▶ Movies

This effect makes images resemble shots from a toy camera by vignetting (darker, blurred image corners) and changing the overall color.

1 Choose [📷].

- Follow steps 1 – 2 in “Specific Scenes” (📖59) and choose [📷].



2 Choose a color tone.

- Press the [▼] button, choose a color tone (either press the [◀][▶] buttons or turn the [🌀] dial), and then press the [📷] button.
- A preview is shown of how your shot will look with the effect applied.

3 Shoot.

Standard	Shots resemble toy camera images.
Warm	Images have a warmer tone than with [Standard].
Cool	Images have a cooler tone than with [Standard].



- Try taking some test shots first to make sure you obtain the desired results.

Shooting with a Soft Focus Effect

▶ Still Images ▶ Movies

This function allows you to shoot images as if a soft focus filter were attached to the camera. You can adjust the effect level as desired.

1 Choose [👤].

- Follow steps 1 – 2 in “Specific Scenes” (📖59) and choose [👤].



2 Choose an effect level.

- Press the [▼] button, choose an effect level (either press the [◀][▶] buttons or turn the [🌀] dial), and then press the [📷] button.
- A preview is shown of how your shot will look with the effect applied.

3 Shoot.



- Try taking some test shots first to make sure you obtain the desired results.

Before Use

Basic Guide

Advanced Guide

Camera Basics

Auto Mode / Hybrid Auto Mode

Other Shooting Modes

P Mode

Tv, Av, and M Mode

Playback Mode

Wireless Features

Setting Menu

Accessories

Appendix

Index



Shooting in Monochrome

► Still Images ► Movies

Shoot images in black and white, sepia, or blue and white.

1 Choose [📷].

- Follow steps 1 – 2 in “Specific Scenes” (📖59) and choose [📷].



2 Choose a color tone.

- Press the [▼] button, choose a color tone (either press the [◀][▶] buttons or turn the [🌀] dial), and then press the [📷] button.
- A preview is shown of how your shot will look with the effect applied.

3 Shoot.

B/W	Black and white shots.
Sepia	Sepia tone shots.
Blue	Blue and white shots.

Special Modes for Other Purposes

Auto Shooting after Face Detection (Smart Shutter)

► Still Images ► Movies

Auto Shooting after Smile Detection (Smile)

► Still Images ► Movies

The camera shoots automatically after detecting a smile, even without you pressing the shutter button.

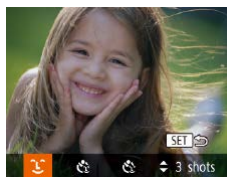

1 Choose [😊].

- Follow steps 1 – 2 in “Specific Scenes” (📖59) and choose [😊], and then press the [▼] button.
- Press the [◀][▶] buttons or turn the [🌀] dial to choose [😊], and then press the [📷] button.
- The camera now enters shooting standby mode, and [Smile Detection on] is displayed.



2 Aim the camera at a person.

- Each time the camera detects a smile, it will shoot after the lamp lights up.
- To pause smile detection, press the [◀] button. Press the [▶] button again to resume detection.

Before Use

Basic Guide

Advanced Guide

Camera Basics

Auto Mode /
Hybrid Auto Mode

Other Shooting Modes

P Mode

Tv, Av, and M Mode

Playback Mode

Wireless Features

Setting Menu

Accessories

Appendix

Index

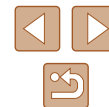



- Switch to another mode when you finish shooting, or the camera will continue shooting each time a smile is detected.



- You can also shoot as usual by pressing the shutter button.
- The camera can detect smiles more easily when subjects face the camera and open their mouth wide enough so that teeth are visible.
- To change the number of shots, press the [▲][▼] buttons after choosing [📷] in step 1.
- Automatic shooting is not available while you are holding down the [📷] button.

Auto Shooting after Wink Detection (Wink Self-Timer)

▶ Still Images ▶ Movies

Aim the camera at a person and press the shutter button all the way down. The camera will shoot about two seconds after a wink is detected.



1 Choose [📷].

- Follow steps 1 – 2 in “Specific Scenes” (📖59) and choose [📷], and then press the [▼] button.
- Press the [◀][▶] buttons or turn the [🌀] dial to choose [📷], and then press the [📷] button.

2 Compose the shot and press the shutter button halfway.

- Make sure a green frame is displayed around the face of the person who will wink.



- If the wink is not detected, wink again slowly and deliberately.
- Winking may not be detected if eyes are obscured by hair, a hat, or glasses.
- Closing and opening both eyes at once will also be detected as a wink.
- If winking is not detected, the camera will shoot about 15 seconds later.
- To change the number of shots, press the [▲][▼] buttons after choosing [📷] in step 1.
- If no one is in the shooting area when the shutter button is pressed all the way down, the camera will shoot after a person enters the shooting area and winks.
- The zoom factor cannot be changed with the [📷] button after you press the shutter button all the way down.

3 Press the shutter button all the way down.

- The camera now enters shooting standby mode, and [Wink to take picture] is displayed.
- The lamp blinks and the self-timer sound is played.

4 Face the camera and wink.

- The camera will shoot about two seconds after detecting a wink by the person whose face is inside the frame.
- To cancel shooting after you have triggered the self-timer, press the [MENU] button.

Before Use

Basic Guide

Advanced Guide

Camera Basics

Auto Mode / Hybrid Auto Mode

Other Shooting Modes

P Mode

Tv, Av, and M Mode

Playback Mode

Wireless Features

Setting Menu

Accessories

Appendix

Index



Auto Shooting after Detecting New Person (Face Self-Timer)

► Still Images ► Movies

The camera will shoot about two seconds after detecting that the face of another person (such as the photographer) has entered the shooting area (77). This is useful when including yourself in group photos or similar shots.



1 Choose [Self-Timer].

- Follow steps 1 – 2 in “Specific Scenes” (59) and choose [Self-Timer], and then press the [Down Arrow] button.
- Press the [Left Arrow]/[Right Arrow] buttons or turn the [Dial] to choose [Self-Timer], and then press the [OK] button.

2 Compose the shot and press the shutter button halfway.

- Make sure a green frame is displayed around the face you focus on and white frames around other faces.

3 Press the shutter button all the way down.

- The camera now enters shooting standby mode, and [Look straight at camera to start count down] is displayed.
- The lamp blinks and the self-timer sound is played.



4 Join the subjects in the shooting area and look at the camera.

- After the camera detects a new face, the lamp blinking and self-timer sound will speed up. (When the flash fires, the lamp will remain lit.) About two seconds later, the camera will shoot.
- To cancel shooting after you have triggered the self-timer, press the [MENU] button.



- Even if your face is not detected after you join the others in the shooting area, the camera will shoot about 15 seconds later.
- To change the number of shots, press the [Up Arrow]/[Down Arrow] buttons after choosing [Self-Timer] in step 1.
- The zoom factor cannot be changed with the [Zoom In/Out] button after you press the shutter button all the way down.

Before Use
Basic Guide
Advanced Guide
Camera Basics
Auto Mode / Hybrid Auto Mode
Other Shooting Modes
P Mode
Tv, Av, and M Mode
Playback Mode
Wireless Features
Setting Menu
Accessories
Appendix
Index

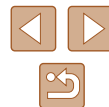

Recording Various Movies

▶ Still Images ▶ Movies

Recording Movies in Standard Mode

▶ Still Images ▶ Movies



1 Enter [MOVIE] mode.

- Set the mode dial to [MOVIE].
- Press the [MENU] button, choose [MOVIE] in the menu, and then choose [MOVIE] (book 28).
- Black bars are displayed on the top and bottom edges of the screen, and the subject is slightly enlarged. The black bars indicate image areas not recorded.

2 Configure the settings to suit the movie (book 172).

3 Shoot.

- Press the movie button.
- To stop movie recording, press the movie button again.

Shooting Movies with Smoother Motion

Shoot movies with smoother motion, at nearly double the frame rate, as follows.



- Follow the steps in “Changing Movie Image Quality” (book 51) to choose [FHD 60P].

Locking or Changing Image Brightness

▶ Still Images ▶ Movies

You can lock the exposure before or during recording or adjust it in 1/3-stop increments within a range of -2 to +2 stops.



1 Lock the exposure.

- Press the [▲] button to lock the exposure. The exposure shift bar is displayed.
- To unlock the exposure, press the [▲] button again.



2 Adjust the exposure.

- Turn the [DISP.] dial to adjust the exposure, as you watch the screen.

3 Shoot (book 67).

Before Use

Basic Guide

Advanced Guide

Camera Basics

Auto Mode /
Hybrid Auto Mode

Other Shooting Modes

P Mode

Tv, Av, and M Mode

Playback Mode

Wireless Features

Setting Menu

Accessories

Appendix

Index



Disabling Auto Slow Shutter

▶ Still Images ▶ Movies

Auto slow shutter can be disabled if movement in movies is rough. However, under low light, movies may look dark.



- Press the [MENU] button, choose [Auto slow shutter] on the [CAMERA] tab, and then choose [Disable] (📖29).
- To restore the original setting, repeat this process but choose [Enable].

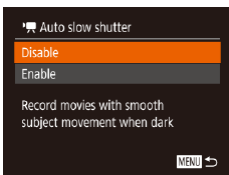

- Auto slow shutter is only available for [FHD (60P)] movies.

Correcting Severe Camera Shake

▶ Still Images ▶ Movies

Counteract severe camera shake, such as when recording while moving. The portion of images displayed changes more than for [Standard], and subjects are further enlarged.

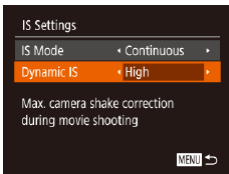

- Follow the steps in “Recording Movies with Subjects at the Same Size Shown before Shooting” (📖53) to choose [High].



- [Dynamic IS] is not available when [IS Mode] is set to [Off] (📖53).
- Only [Standard] is available when the movie quality is set to [VGA (30P)].

Sound Settings

▶ Still Images ▶ Movies

Deactivating the Wind Filter

Noise caused by strong wind can be reduced. However, the recording may sound unnatural when this option is used when there is no wind. In this case, you can deactivate the wind filter.



- Press the [MENU] button, choose [Wind Filter] on the [CAMERA] tab, and then choose [Off] (📖29).

Using the Attenuator

The attenuator can reduce audio distortion in noisy environments. However, in quiet environments, it lowers the sound-recording level.



- Press the [MENU] button, choose [Attenuator] on the [CAMERA] tab, and then choose the desired option (📖29).

Before Use

Basic Guide

Advanced Guide

Camera Basics

Auto Mode / Hybrid Auto Mode

Other Shooting Modes

P Mode

Tv, Av, and M Mode

Playback Mode

Wireless Features

Setting Menu

Accessories

Appendix

Index



Recording Movies in Short Clip Mode

▶ Still Images ▶ Movies

Apply playback effects to brief clips of a few seconds, such as fast motion, slow motion, or replay. Clips recorded in this mode may be included in Story Highlights albums (📖108).

1 Enter [📷] mode.

- Set the mode dial to [📷].
- Press the [ⓘ] button, choose [📷] in the menu, and then choose [📷] (📖28).
- Black bars displayed on the top and bottom edges of the screen indicate image areas not recorded.

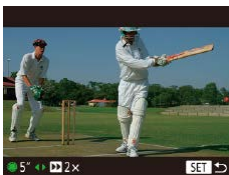

2 Specify the shooting time and playback effect.

- Press the [▼] button.
- Turn the [🕒] dial to set the shooting time (4 – 6 sec.), and press the [⏪][⏩] buttons to set the playback effect.

3 Shoot (📖67).

- A bar showing the elapsed time is displayed.

Playback Effects

▶▶ 2x	Playback in fast motion
▶ 1x	Playback at normal speed
⏪ 1/2x	Playback in slow motion
🔄	Normal playback with the last two seconds rewind and played again in slow motion



- Sound is not recorded in these clips.
- The movie quality is [📷] (📖51) and cannot be changed.

Before Use
Basic Guide
Advanced Guide
Camera Basics
Auto Mode / Hybrid Auto Mode
Other Shooting Modes
P Mode
Tv, Av, and M Mode
Playback Mode
Wireless Features
Setting Menu
Accessories
Appendix
Index

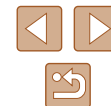

P Mode

More discerning shots, in your preferred shooting style



- Instructions in this chapter apply to the camera with the mode dial set to **[P]** mode.
- **[P]**: Program AE; AE: Auto Exposure
- Before using a function introduced in this chapter in modes other than **[P]**, make sure the function is available in that mode (172).

Shooting in Program AE ([P] Mode)

► Still Images ► Movies

You can customize many function settings to suit your preferred shooting style.



1 Enter [P] mode.

- Set the mode dial to **[P]**.

2 Customize the settings as desired (71 – 83), and then shoot.



- If the optimum exposure cannot be obtained when you press the shutter button halfway, the shutter speed and aperture value are displayed in orange. In this case, try adjusting the ISO speed (72) or activating the flash (if subjects are dark, 81), which may enable optimum exposure.
- Movies can be recorded in **[P]** mode as well, by pressing the movie button. However, some FUNC. (28) and MENU (29) settings may be automatically adjusted for movie recording.

Before Use

Basic Guide

Advanced Guide

Camera Basics

Auto Mode /
Hybrid Auto Mode

Other Shooting Modes

P Mode

Tv, Av, and M Mode

Playback Mode

Wireless Features

Setting Menu

Accessories

Appendix

Index



Image Brightness (Exposure)

Adjusting Image Brightness (Exposure Compensation)

► Still Images ► Movies

The standard exposure set by the camera can be adjusted in 1/3-stop increments, in a range of -2 to +2.



- Press the [▲] button. As you watch the screen, turn the [M/AF] dial to adjust brightness, and then press the [▲] button again when finished.
- The correction level you specified is now displayed.

Locking Image Brightness / Exposure (AE Lock)

► Still Images ► Movies

Before shooting, you can lock the exposure, or you can specify focus and exposure separately.



1 Lock the exposure.

- Aim the camera at the subject to shoot with the exposure locked. With the shutter button pressed halfway, press the [▲] button.
- [★] is displayed, and the exposure is locked.
- To unlock AE, release the shutter button and press the [▲] button again. In this case, [★] is no longer displayed.

2 Compose the shot and shoot.

- After one shot, AE is unlocked and [★] is no longer displayed.



- AE: Auto Exposure
- After the exposure is locked, you can adjust the combination of shutter speed and aperture value by turning the [M/AF] dial (Program Shift).

Changing the Metering Method

► Still Images ► Movies

Adjust the metering method (how brightness is measured) to suit shooting conditions as follows.



- Press the [M/AF] button, choose [M/AF] in the menu, and choose the desired option ([28]).
- The option you configured is now displayed.

Evaluative	For typical shooting conditions, including backlit shots. Automatically adjusts exposure to match the shooting conditions.
Center Weighted Avg.	Determines the average brightness of light across the entire image area, calculated by treating brightness in the central area as more important.
Spot	Metering restricted to within the [] (Spot AE Point frame), displayed in the center of the screen.

Before Use

Basic Guide

Advanced Guide

Camera Basics

Auto Mode / Hybrid Auto Mode

Other Shooting Modes

P Mode

Tv, Av, and M Mode

Playback Mode

Wireless Features

Setting Menu

Accessories

Appendix

Index



Changing the ISO Speed

► Still Images ► Movies

Set the ISO speed to [AUTO] for automatic adjustment to suit the shooting mode and conditions. Otherwise, set a higher ISO speed for higher sensitivity, or a lower value for lower sensitivity.

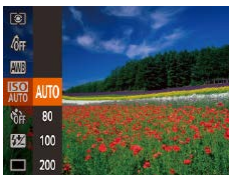

- Press the **[ISO]** button, choose **[ISO]** in the menu, and choose the desired option (📖28).
- The option you configured is now displayed.



- To view the automatically determined ISO speed when you have set the ISO speed to [AUTO], press the shutter button halfway.
- Although choosing a lower ISO speed may reduce image graininess, there may be a greater risk of subject and camera shake in some shooting conditions.
- Choosing a higher ISO speed will increase shutter speed, which may reduce subject and camera shake and increase the flash range. However, shots may look grainy.

Correcting Image Brightness (i-Contrast)

► Still Images ► Movies

Before shooting, excessively bright or dark image areas (such as faces or backgrounds) can be detected and automatically adjusted to the optimal brightness. Insufficient overall image contrast can also be automatically corrected before shooting to make subjects stand out better.



- Press the **[MENU]** button, choose **[i-Contrast]** on the **[CAMERA]** tab, and then choose **[Auto]** (📖29).
- Once the setting is complete, **[Ci]** is displayed.



- Under some shooting conditions, correction may be inaccurate or may cause images to appear grainy.



- You can also correct existing images (📖104).

Before Use

Basic Guide

Advanced Guide

Camera Basics

Auto Mode /
Hybrid Auto Mode

Other Shooting Modes

P Mode

Tv, Av, and M Mode

Playback Mode

Wireless Features

Setting Menu

Accessories

Appendix

Index

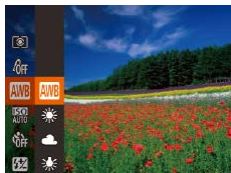

Image Colors

Capturing Natural Colors (White Balance)

▶ Still Images ▶ Movies

By adjusting white balance (WB), you can make image colors look more natural for the scene you are shooting.



- Press the **[WB]** button, choose **[AWB]** in the menu, and choose the desired option (📖28).
- The option you configured is now displayed.

[AWB] Auto	Automatically sets the optimal white balance for the shooting conditions.
Day Light	For shooting outdoors in fair weather.
Cloudy	For shooting in cloudy weather or at twilight.
Tungsten	For shooting under ordinary incandescent lighting.
Fluorescent	For shooting under white fluorescent lighting.
Fluorescent H	For shooting under daylight fluorescent lighting.
Custom	For manually setting a custom white balance (📖73).

Custom White Balance

▶ Still Images ▶ Movies

For image colors that look natural under the light in your shot, adjust white balance to suit the light source where you are shooting. Set the white balance under the same light source that will illuminate your shot.



- Follow the steps in “Capturing Natural Colors (White Balance)” (📖73) to choose **[MENU]**.
- Aim the camera at a plain white subject, so that the entire screen is white. Press the **[MENU]** button.
- The tint of the screen changes once the white balance data has been recorded.



- Colors may look unnatural if you change camera settings after recording white balance data.

Before Use

Basic Guide

Advanced Guide

Camera Basics

Auto Mode /
Hybrid Auto Mode

Other Shooting Modes

P Mode

Tv, Av, and M Mode

Playback Mode

Wireless Features

Setting Menu

Accessories

Appendix

Index



Changing Image Color Tones (My Colors)

► Still Images ► Movies

Change image color tones as desired, such as converting images to sepia or black and white.



- Press the **[MENU]** button, choose **[My Colors]** in the menu, and choose the desired option (**[28]**).
- The option you configured is now displayed.

[OFF] My Colors Off	–
[V] Vivid	Emphasizes contrast and color saturation, making images sharper.
[N] Neutral	Tones down contrast and color saturation for subdued images.
[Se] Sepia	Creates sepia tone images.
[B/W] B/W	Creates black and white images.
[P] Positive Film	Combines the effects of Vivid Blue, Vivid Green, and Vivid Red to produce intense yet natural-looking colors resembling images on positive film.
[L] Lighter Skin Tone	Lightens skin tones.
[D] Darker Skin Tone	Darkens skin tones.
[B] Vivid Blue	Emphasizes blues in images. Makes the sky, ocean, and other blue subjects more vivid.
[G] Vivid Green	Emphasizes greens in images. Makes mountains, foliage, and other green subjects more vivid.
[R] Vivid Red	Emphasizes reds in images. Makes red subjects more vivid.
[C] Custom Color	Adjust contrast, sharpness, color saturation, and other qualities as desired ([74]).



- White balance (**[73]**) cannot be set in **[Se]** or **[B/W]** modes.
- With **[L]** and **[D]** modes, colors other than people's skin tone may change. These settings may not produce the expected results with some skin tones.

Custom Color

► Still Images ► Movies

Choose the desired level of image contrast, sharpness, color saturation, red, green, blue, and skin tones in a range of 1 – 5.

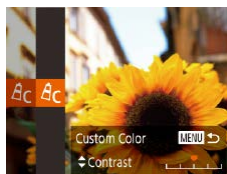

1 Access the setting screen.

- Follow the steps in “Changing Image Color Tones (My Colors)” (**[74]**) to choose **[C]**, and then press the **[MENU]** button.

2 Configure the setting.

- Press the **[▲]**/**[▼]** buttons to choose an item, and then specify the value by pressing the **[◀]**/**[▶]** buttons or turning the **[DIAL]**.
- For stronger/more intense effects (or darker skin tones), adjust the value to the right, and for weaker/lighter effects (or lighter skin tones), adjust the value to the left.
- Press the **[MENU]** button to complete the setting.

Before Use

Basic Guide

Advanced Guide

Camera Basics

Auto Mode /
Hybrid Auto Mode

Other Shooting Modes

P Mode

Tv, Av, and M Mode

Playback Mode

Wireless Features

Setting Menu

Accessories

Appendix

Index



Shooting Range and Focusing

Shooting Close-Ups (Macro)

► Still Images ► Movies

To restrict the focus to subjects at close range, set the camera to [M]. For details on the range of focus, see “Lens” (181).

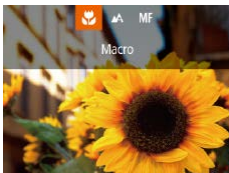

- Press the [L] button, choose [M] (either press the [L][R] buttons or turn the [D] dial), and then press the [OK] button.
- Once the setting is complete, [M] is displayed.



- If the flash fires, vignetting may occur.
- In the yellow bar display area below the zoom bar, [M] will turn gray and the camera will not focus.



- To prevent camera shake, try mounting the camera on a tripod and shooting with the camera set to [C] (44).

Shooting in Manual Focus Mode

► Still Images ► Movies

When focusing is not possible in AF mode, use manual focus. You can specify the general focal position and then press the shutter button halfway to have the camera determine the optimal focal position near the position you specified. For details on the range of focus, see “Lens” (181).

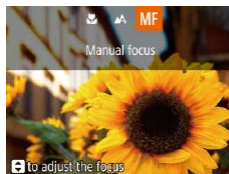

(1)

1 Choose [MF].

- Press the [L] button, choose [MF] (either press the [L][R] buttons or turn the [D] dial), and then press the [OK] button.
- [MF] and the MF indicator are displayed.

2 Specify the general focal position.

- Referring to the on-screen MF indicator (1, which shows the distance and focal position) and the magnified display, press the [▲][▼] buttons or turn the [D] dial to specify the general focal position, and then press the [OK] button.
- To adjust the magnification, press the [R] button.

3 Fine-tune the focus.

- Press the shutter button halfway to have the camera fine-tune the focal position (Safety MF).

Before Use

Basic Guide

Advanced Guide

Camera Basics

Auto Mode /
Hybrid Auto Mode

Other Shooting Modes

P Mode

Tv, Av, and M Mode

Playback Mode

Wireless Features

Setting Menu

Accessories

Appendix

Index





- When you focus manually, the AF frame mode (📖77) is [Center] and AF frame size (📖77) is [Normal], and these settings cannot be changed.
- Focusing is possible when using the digital zoom (📖39) or digital tele-converter (📖77), but the magnified display will not appear.



- To focus more accurately, try attaching the camera to a tripod to stabilize it.
- You can enlarge or hide the magnified display area by adjusting MENU (📖29) > [📷] tab > [MF-Point Zoom] settings.
- To deactivate automatic focus fine-tuning when the shutter button is pressed halfway, choose MENU (📖29) > [📷] tab > [Safety MF] > [Off].

■ Easily Identifying the Focus Area (MF Peaking)

▶ Still Images ▶ Movies

Edges of subjects in focus are displayed in color to make manual focusing easier. You can adjust the colors and the sensitivity (level) of edge detection as needed.

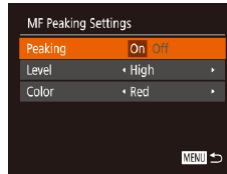

1 Access the setting screen.

- Press the [MENU] button, choose [MF Peaking Settings] on the [📷] tab, and then choose [On] (📖29).

2 Configure the setting.

- Choose a menu item to configure, and then choose the desired option (📖29).



- Colors displayed for MF peaking are not recorded in your shots.

Before Use

Basic Guide

Advanced Guide

Camera Basics

Auto Mode /
Hybrid Auto Mode

Other Shooting Modes

P Mode

Tv, Av, and M Mode

Playback Mode

Wireless Features

Setting Menu

Accessories

Appendix

Index

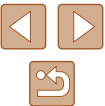

Digital Tele-Converter

▶ Still Images ▶ Movies

The focal length of the lens can be increased by approximately 1.6x or 2.0x. This can reduce camera shake because the shutter speed is faster than it would be if you zoomed (including using digital zoom) in to the same zoom factor.

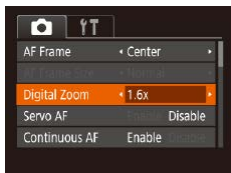

- Press the [MENU] button, choose [Digital Zoom] on the [CAMERA] tab, and then choose the desired option (📖29).
- The view is enlarged and the zoom factor is displayed on the screen.



- The shutter speed may be equivalent when you move the zoom lever all the way toward [T] for maximum telephoto, and when you zoom in to enlarge the subject to the same size following step 2 in "Zooming In Closer on Subjects (Digital Zoom)" (📖39).

Changing the AF Frame Mode

▶ Still Images ▶ Movies

Change the AF (auto focus) frame mode to suit the shooting conditions as follows.

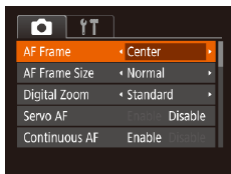

- Press the [MENU] button, choose [AF Frame] on the [CAMERA] tab, and then choose the desired option (📖29).

Center

▶ Still Images ▶ Movies

One AF frame is displayed in the center. Effective for reliable focusing.



- A yellow AF frame is displayed with [AF-LOCK] if the camera cannot focus when you press the shutter button halfway.



- To reduce the AF frame size, press the [MENU] button and set [AF Frame Size] on the [CAMERA] tab to [Small] (📖29).
- The AF frame size is set to [Normal] when you use the digital zoom (📖39) or digital tele-converter (📖77), and in manual focus mode (📖75).
- To compose shots so that subjects are positioned at the edge or in a corner, first aim the camera to capture the subject in an AF frame, and then hold the shutter button halfway down. As you continue to hold the shutter button halfway, recompose the shot as desired, and then press the shutter button all the way down (Focus Lock).

Face AiAF

▶ Still Images ▶ Movies

- Detects people's faces, and then sets the focus, exposure (evaluative metering only), and white balance ([WB] only).
- After you aim the camera at the subject, a white frame is displayed around the person's face determined by the camera to be the main subject, and up to two gray frames are displayed around other detected faces.
- When the camera detects movement, frames will follow moving subjects, within a certain range.
- After you press the shutter button halfway, up to nine green frames are displayed around faces in focus.

Before Use

Basic Guide

Advanced Guide

Camera Basics

Auto Mode /
Hybrid Auto Mode

Other Shooting Modes

P Mode

Tv, Av, and M Mode

Playback Mode

Wireless Features

Setting Menu

Accessories

Appendix

Index





- If faces are not detected, or when only gray frames are displayed (without a white frame), up to nine green frames are displayed in the areas in focus when you press the shutter button halfway.
- If faces are not detected when Servo AF (📖79) is set to [Enable], the AF frame is displayed in the center of the screen when you press the shutter button halfway.
- Examples of faces that cannot be detected:
 - Subjects that are distant or extremely close
 - Subjects that are dark or light
 - Faces in profile, at an angle, or partly hidden
- The camera may misinterpret non-human subjects as faces.
- No AF frames are displayed if the camera cannot focus when you press the shutter button halfway.



- When the subject is detected, the camera beeps and [📷] is displayed. Even if the subject moves, the camera will continue to track the subject within a certain range.
- If no subject is detected, [📷] is displayed.
- To cancel tracking, press the [⏪] button again.

3 Shoot.

- Press the shutter button halfway. [📷] changes to a blue [📷], which follows the subject as the camera continues to adjust the focus and exposure (Servo AF) (📖79).
- Press the shutter button all the way down to shoot.
- Even after your shot, [📷] is still displayed and the camera continues to track the subject.



- [Servo AF] (📖79) is set to [Enable] and cannot be changed.
- Tracking may not be possible when subjects are too small or move too rapidly, or when subject color or brightness matches that of the background too closely.
- [📷] is not available.



- The camera can detect subjects even if you press the shutter button halfway without pressing the [⏪] button. After your shot, [📷] is displayed in the center of the screen.
- When shooting in [MF] mode (📖75), press and hold the [⏪] button for at least one second.
- If [Face ID] is set to [On], names will not be displayed when registered people are detected, but the names will be recorded in the still images (📖45). However, when you choose a registered person as the subject, their name is displayed.

Choosing Subjects to Focus On (Tracking AF)

▶ Still Images ▶ Movies

Shoot after choosing a subject to focus on as follows.

1 Choose [Tracking AF].

- Follow the steps in “Changing the AF Frame Mode” (📖77) to choose [Tracking AF].
- [📷] is displayed in the center of the screen.



2 Choose a subject to focus on.

- Aim the camera so that [📷] is on the desired subject, and then press the [⏪] button.

Before Use
Basic Guide
Advanced Guide
Camera Basics
Auto Mode / Hybrid Auto Mode
Other Shooting Modes
P Mode
Tv, Av, and M Mode
Playback Mode
Wireless Features
Setting Menu
Accessories
Appendix
Index

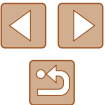

Shooting with Servo AF

► Still Images ► Movies

This mode helps avoid missing shots of subjects in motion, because the camera continues to focus on the subject and adjust the exposure as long as you press the shutter button halfway.



1 Configure the setting.

- Press the [MENU] button, choose [Servo AF] on the [CAMERA] tab, and then choose [Enable] (📖29).

2 Focus.

- The focus and exposure are maintained where the blue AF frame is displayed while you are pressing the shutter button halfway.



- Focusing may not be possible in some shooting conditions.
- In low-light conditions, Servo AF may not be activated (AF frames may not turn blue) when you press the shutter button halfway. In this case, the focus and exposure are set according to the specified AF frame mode.
- If optimum exposure cannot be obtained, the shutter speed and aperture value are displayed in orange. Release the shutter button, and then press it halfway again.
- AF lock shooting is not available.
- Not available when using the self-timer (📖43).

Changing the Focus Setting

► Still Images ► Movies

You can change default camera operation of constantly focusing on subjects it is aimed at, even when the shutter button is not pressed. Instead, you can limit camera focusing to the moment you press the shutter button halfway.



- Press the [MENU] button, choose [Continuous AF] on the [CAMERA] tab, and then choose [Disable] (📖29).

Enable	Helps avoid missing sudden photo opportunities, because the camera constantly focuses on subjects until you press the shutter button halfway.
Disable	Conserves battery power, because the camera does not focus constantly.

Before Use
Basic Guide
Advanced Guide
Camera Basics
Auto Mode / Hybrid Auto Mode
Other Shooting Modes
P Mode
Tv, Av, and M Mode
Playback Mode
Wireless Features
Setting Menu
Accessories
Appendix
Index



Shooting with the AF Lock

► Still Images ► Movies

The focus can be locked. After you lock the focus, the focal position will not change even when you release your finger from the shutter button.

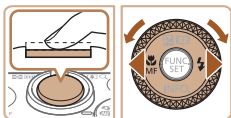

1 Lock the focus.

- With the shutter button pressed halfway, press the [L] button.
- The focus is now locked, and [MF] and the MF indicator are displayed.
- To unlock the focus, after you release the shutter button, press the [L] button again and choose [AF] (either press the [L][R] buttons or turn the [Fn] dial).

2 Compose the shot and shoot.

Shooting Continuously as the Camera Keeps the Subject in Focus

► Still Images ► Movies

Shoot continuously as the camera keeps the subject in focus. For details on the continuous shooting speed, see “Shooting” (182).



1 Configure the setting.

- Press the [Fn] button, choose [AF] in the menu, and then choose [AF] (128).
- Once the setting is complete, [AF] is displayed.

2 Shoot.

- Hold the shutter button all the way down to shoot continuously.
- The images are managed together as a group (92).



- In [AF] mode (59), manual focus mode (75), or when AF is locked (80), [AF] is changed to [MF].
- Cannot be used with the self-timer (43).
- Shooting may stop momentarily or continuous shooting may slow down depending on shooting conditions, camera settings, and the zoom position.
- As more shots are taken, shooting may slow down.
- Shooting may slow down if the flash fires.
- Continuous shooting is not available in [AF] Auto mode (40), even if you choose [AF].

Before Use

Basic Guide

Advanced Guide

Camera Basics

Auto Mode /
Hybrid Auto Mode

Other Shooting Modes

P Mode

Tv, Av, and M Mode

Playback Mode

Wireless Features

Setting Menu

Accessories

Appendix

Index



Flash

Changing the Flash Mode

► Still Images ► Movies

You can change the flash mode to match the shooting scene. For details on the flash range, see “Flash” (p.181).

1 Raise the flash.

- Move the [Flash] switch.

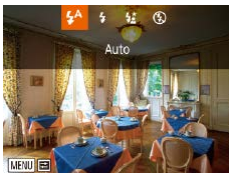

2 Configure the setting.

- Press the [Right] button, choose a flash mode (either press the [Left/Right] buttons or turn the [Dial]), and then press the [OK] button.
- The option you configured is now displayed.



- The setting screen cannot be accessed by pressing the [Right] button when the flash is lowered. Move the [Flash] switch to raise the flash, then configure the setting.

Auto

Fires automatically in low-light conditions.

On

Fires for each shot.

Slow Synchro

Fires to illuminate the main subject (such as people) while shooting at a slower shutter speed to illuminate backgrounds out of flash range.



- In [Slow Synchro] mode, mount the camera on a tripod or take other measures to keep it still and prevent camera shake. Additionally, you should set [IS Mode] to [Off] when using a tripod or other means to secure the camera (p.83).
- In [Slow Synchro] mode, even after the flash fires, ensure that the main subject does not move until the shutter sound is finished playing.

Off

For shooting without the flash.



- If a blinking [Flash] icon is displayed when you press the shutter button halfway in camera-shake inducing, low-light conditions, mount the camera on a tripod or take other measures to keep it still.

Before Use

Basic Guide

Advanced Guide

Camera Basics

Auto Mode /
Hybrid Auto Mode

Other Shooting Modes

P Mode

Tv, Av, and M Mode

Playback Mode

Wireless Features

Setting Menu

Accessories

Appendix

Index



Adjusting the Flash Exposure Compensation

► Still Images ► Movies

Just as with regular exposure compensation (📖71), you can adjust the flash exposure from -2 to +2 stops, in 1/3-stop increments.



- Press the [Fn] button, choose [Fn] in the menu, and adjust the setting by either pressing the [▲][▼] buttons or turning the [DIAL] dial (📖28).
- The correction level you specified is now displayed.



- When there is a risk of overexposure, the camera automatically adjusts the shutter speed or aperture value for flash shots to reduce washed-out highlights and shoot at optimal exposure. However, you can deactivate automatic adjustment of the shutter speed and aperture value by accessing MENU (📖29) and choosing [📷] tab > [Flash settings] > [Safety FE] > [Off].
- You can also configure the flash exposure compensation by accessing MENU (📖29) and choosing [📷] tab > [Flash settings] > [Flash Exp. Comp].
- You can also access the [Flash settings] MENU screen (📖29) when the flash is up by pressing the [Fn] button and immediately pressing the [MENU] button.

Shooting with the FE Lock

► Still Images ► Movies

Just as with the AE lock (📖71), you can lock the exposure for flash shots.



1 Raise the flash and set it to [🔆] (📖81).

2 Lock the flash exposure.

- Aim the camera at the subject to shoot with the exposure locked. With the shutter button pressed halfway, press the [▲] button.
- The flash fires, and when [✳] is displayed, the flash output level is retained.
- To unlock FE, release the shutter button and press the [▲] button again. In this case, [✳] is no longer displayed.

3 Compose the shot and shoot.

- After one shot, FE is unlocked and [✳] is no longer displayed.



- FE: Flash Exposure

Before Use

Basic Guide

Advanced Guide

Camera Basics

Auto Mode /
Hybrid Auto Mode

Other Shooting Modes

P Mode

Tv, Av, and M Mode

Playback Mode

Wireless Features

Setting Menu

Accessories

Appendix

Index



Other Settings

Changing the Compression Ratio (Image Quality)

► Still Images ► Movies

Choose from two compression ratios, [S] (Super Fine) and [F] (Fine), as follows. For guidelines on how many shots at each compression ratio can fit on a memory card, see “Recording” (182).



- Press the [Q] button, choose [F] in the menu, and choose the desired option (28).

Changing the IS Mode Settings

► Still Images ► Movies

You can keep image stabilization off until the moment you shoot.

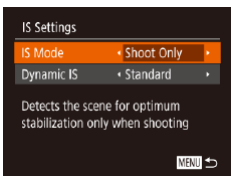

- Follow steps 1 – 2 in “Deactivating Image Stabilization” (53) and choose [Shoot Only].



- If image stabilization cannot prevent camera shake, mount the camera on a tripod or take other measures to hold it still. In this case, set [IS Mode] to [Off].
- The setting is changed to [Continuous] for movie recording.

Before Use

Basic Guide

Advanced Guide

Camera Basics

Auto Mode /
Hybrid Auto Mode

Other Shooting Modes

P Mode

Tv, Av, and M Mode

Playback Mode

Wireless Features

Setting Menu

Accessories

Appendix

Index



Tv, Av, and M Mode

Take smarter, more sophisticated shots, and customize the camera for your shooting style

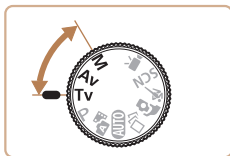

- Instructions in this chapter apply to the camera as set to the respective mode.

Specific Shutter Speeds ([Tv] Mode)

► Still Images ► Movies

Set your preferred shutter speed before shooting as follows. The camera automatically adjusts the aperture value to suit your shutter speed. For details on available shutter speeds, see “Shutter” (📖181).

1 Enter [Tv] mode.

- Set the mode dial to [Tv].



2 Set the shutter speed.

- Turn the [ⓘ] dial to set the shutter speed.



- In conditions requiring slower shutter speeds, there may be a delay before you can shoot again, as the camera processes images to reduce noise.
- When shooting at low shutter speeds on a tripod, you should set [IS Mode] to [Off] (📖83).
- Maximum shutter speed with the flash is 1/2000 second. If you specify a faster speed, the camera will automatically reset the speed to 1/2000 second before shooting.
- With shutter speeds of 1.3 seconds or slower, ISO speed is [80] and cannot be changed.
- Orange display of the aperture value when you press the shutter button halfway indicates that the optimum exposure has not been obtained. Adjust the shutter speed until the aperture value is displayed in white, or use safety shift (📖85).



- [Tv]: Time value

Before Use

Basic Guide

Advanced Guide

Camera Basics

Auto Mode /
Hybrid Auto Mode

Other Shooting Modes

P Mode

Tv, Av, and M Mode

Playback Mode

Wireless Features

Setting Menu

Accessories

Appendix

Index



Specific Aperture Values ([Av] Mode)

► Still Images ► Movies

Set your preferred aperture value before shooting as follows. The camera automatically adjusts the shutter speed to suit your aperture value. For details on available aperture values, see “Aperture” (181).

1 Enter [Av] mode.

- Set the mode dial to [Av].



2 Set the aperture value.

- Turn the [Q] dial to set the aperture value.



- Orange display of the shutter speed when you press the shutter button halfway indicates that the optimum exposure has not been obtained. Adjust the aperture value until the shutter speed is displayed in white, or use safety shift (see below).



- [Av]: Aperture value (size of the opening made by the diaphragm in the lens)
- In [Tv] and [Av] modes, press the [MENU] button and set [Safety shift] on the [CAM] tab to [On] (29) to have the camera automatically adjust the shutter speed and aperture value when there are exposure problems, so that you can shoot at the optimum exposure. However, safety shift is disabled when the flash fires.

Specific Shutter Speeds and Aperture Values ([M] Mode)

► Still Images ► Movies

Follow these steps before shooting to set your preferred shutter speed and aperture value to obtain the desired exposure.

For details on available shutter speeds and aperture values, see “Shutter” (181) and “Aperture” (181).

1 Enter [M] mode.

- Set the mode dial to [M].

2 Configure the setting.

- Press the [▲] button to choose shutter speed (1) or aperture value (2), and turn the [Q] dial to specify a value.
- An exposure level mark (4) based on your specified values is shown on the exposure level indicator for comparison to the optimum exposure (3).
- The exposure level mark is shown in orange when the difference from optimum exposure exceeds 2 stops.



(1) (2)
(3)
(4)



Before Use

Basic Guide

Advanced Guide

Camera Basics

Auto Mode /
Hybrid Auto Mode

Other Shooting Modes

P Mode

Tv, Av, and M Mode

Playback Mode

Wireless Features

Setting Menu

Accessories

Appendix

Index





- After you set the shutter speed and aperture value, the exposure level may change if you adjust the zoom or recompose the shot.
- Screen brightness may change depending on your specified shutter speed and aperture value. However, screen brightness remains the same when the flash is up and the mode is set to [⚡].
- To have the setting that is not chosen in step 2 (whether shutter speed or aperture value) automatically adjusted to obtain optimum exposure, hold the shutter button halfway and press the [▲] button. Note that optimum exposure may not be possible with some settings.
- With shutter speeds of 1.3 seconds or slower, ISO speed is [80] and cannot be changed.
- [☐] Auto mode is not available in [M] mode.



- [M]: Manual
- Calculation of optimum exposure is based on the specified metering method (☞71).

Adjusting the Flash Output

▶ Still Images ▶ Movies

Choose from the three flash levels in [M] mode.

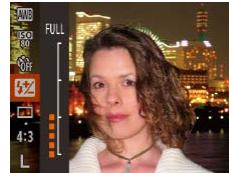

1 Enter [M] mode.

- Set the mode dial to [M].

2 Configure the setting.

- Press the [⊕] button, choose [⚡] in the menu, and adjust the setting by either pressing the [▲][▼] buttons or turning the [⦿] dial (☞28).
- Once the setting is complete, the flash output level is displayed.
[⚡]: Minimum, [⚡.⦿]: Medium, [⚡.⦿.⦿]: Maximum



- You can also set the flash level by accessing MENU (☞29) and choosing [📷] tab > [Flash settings] > [Flash Output].
- You can also set the flash level in [Tv] or [Av] mode by accessing MENU (☞29) and choosing [📷] tab > [Flash settings] > [Flash Mode] > [Manual].
- You can also access the [Flash settings] MENU screen (☞29) when the flash is up by pressing the [▶] button and immediately pressing the [MENU] button.

Before Use

Basic Guide

Advanced Guide

Camera Basics

Auto Mode /
Hybrid Auto Mode

Other Shooting Modes

P Mode

Tv, Av, and M Mode

Playback Mode

Wireless Features

Setting Menu

Accessories

Appendix

Index



Playback Mode

Have fun reviewing your shots, and browse or edit them in many ways

- To prepare the camera for these operations, press the [▶] button to enter Playback mode.



- It may not be possible to play back or edit images that were renamed or already edited on a computer, or images from other cameras.

Viewing

▶ Still Images ▶ Movies

After shooting images or movies, you can view them on the screen as follows.

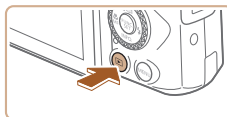

1 Enter Playback mode.

- Press the [▶] button.
- Your last shot is displayed.



2 Choose images.

- To view the previous image, press the [◀] button or turn the [●] dial counterclockwise. To view the next image, press the [▶] button or turn the [●] dial clockwise.
- Press and hold the [◀][▶] buttons to browse through images quickly.

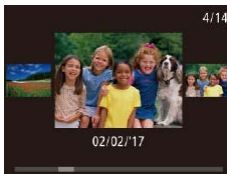

- To access this screen (Scroll Display mode), turn the [●] dial rapidly. In this mode, turn the [●] dial to browse through images.
- To return to single-image display, press the [⊕] button.
- To browse images grouped by shooting date, press the [▲][▼] buttons in Scroll Display mode.

Before Use

Basic Guide

Advanced Guide

Camera Basics

Auto Mode / Hybrid Auto Mode

Other Shooting Modes

P Mode

Tv, Av, and M Mode

Playback Mode

Wireless Features

Setting Menu

Accessories

Appendix

Index



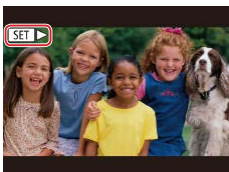

- Movies are identified by a [SET ▶] icon. To play movies, go to step 3.

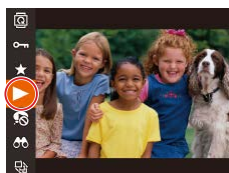

3 Play movies.

- To start playback, press the [⏪] button, choose [▶] (either press the [▲][▼] buttons or turn the [DISK] dial), and then press the [⏩] button again.

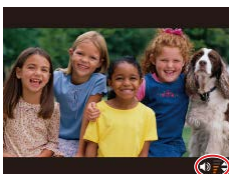

4 Adjust the volume.

- Press the [▲][▼] buttons to adjust the volume.
- To adjust the volume when the volume indicator (1) is no longer displayed, press the [▲][▼] buttons.

(1) 5 Pause playback.

- To pause or resume playback, press the [⏸] button.
- After the movie is finished, [SET ▶] is displayed.



- To switch to Shooting mode from Playback mode, press the shutter button halfway.
- To deactivate Scroll Display, choose MENU (⏏ 29) > [▶] tab > [Scroll Display] > [Off].
- To have the most recent shot displayed when you enter Playback mode, choose MENU (⏏ 29) > [▶] tab > [Resume] > [Last shot].
- To change the transition shown between images, access MENU (⏏ 29) and choose your desired effect on the [▶] tab > [Transition Effect].

Switching Display Modes

▶ Still Images ▶ Movies

Press the [▼] button to view other information on the screen, or to hide the information. For details on the information displayed, see “Playback (Detailed Information Display)” (ⓘ 171).

	No Information Display
	Simple Information Display
	Detailed Information Display
	GPS Information Display

Before Use

Basic Guide

Advanced Guide

Camera Basics

Auto Mode / Hybrid Auto Mode

Other Shooting Modes

P Mode

Tv, Av, and M Mode

Playback Mode

Wireless Features

Setting Menu

Accessories

Appendix

Index



Overexposure Warning (for Image Highlights)

▶ Still Images ▶ Movies

Washed-out highlights in the image flash on the screen in detailed information display (📖88).

Histogram

▶ Still Images ▶ Movies

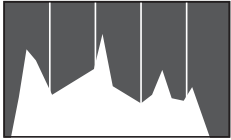

- The graph in detailed information display (📖88) is a histogram showing the distribution of brightness in the image. The horizontal axis represents the degree of brightness, and the vertical axis, how much of the image is at each level of brightness. Viewing the histogram is a way to check exposure.

GPS Information Display

▶ Still Images ▶ Movies



- Still images and movies you shoot can be geotagged using GPS information (such as latitude, longitude, and elevation) from a Bluetooth enabled smartphone (📖136). You can review this information in the GPS information display.
- Latitude, longitude, elevation, and UTC (shooting date and time) are listed from top to bottom.



- GPS information display is not available for images that lack this information.
- [---] is shown instead of numerical values for items not available on your smartphone or items not recorded correctly.



- UTC: Coordinated Universal Time, essentially the same as Greenwich Mean Time

Viewing Short Movies Recorded in Creative Shot Mode (Creative Shot Movies)

▶ Still Images ▶ Movies

Play back Creative Shot movies recorded in [📷] mode (📖56).

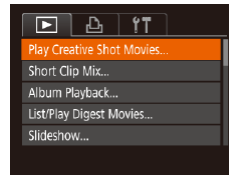

1 Choose a movie.

- Press the [MENU] button and choose [Play Creative Shot Movies] on the [▶] tab (📖29).

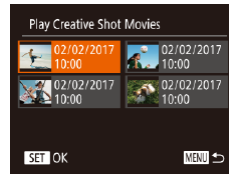

2 Play the movie.

- Select a movie and press the [▶] button to play it.

Before Use

Basic Guide

Advanced Guide

Camera Basics

Auto Mode / Hybrid Auto Mode

Other Shooting Modes

P Mode

Tv, Av, and M Mode

Playback Mode

Wireless Features

Setting Menu

Accessories

Appendix

Index



Viewing Short Movies Created When Shooting Still Images (Digest Movies)

▶ Still Images ▶ Movies

View digest movies recorded automatically in [A] mode (835) on a day of still image shooting as follows.



1 Choose an image.

- Press the [◀][▶] buttons or turn the [DIAL] dial to choose a still image labeled with [SET].

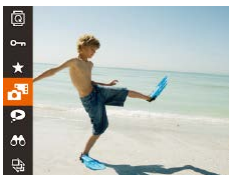

2 Play the digest movie.

- Press the [OK] button, and then choose [List/Play Digest Movies...] in the menu (828).
- The digest movie recorded automatically on the day of still image shooting is played back from the beginning.



- After a moment, [SET] will no longer be displayed when you are using the camera with information display deactivated (88).

Viewing by Date

Digest movies can be viewed by date.

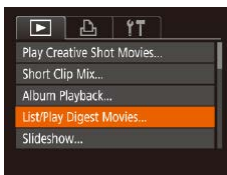

1 Choose a movie.

- Press the [MENU] button, choose [List/Play Digest Movies] on the [▶] tab, and then choose a date (829).

2 Play the movie.

- Press the [OK] button to start playback.

Checking People Detected in Face ID

▶ Still Images ▶ Movies

If you switch the camera to simple information display mode (88), the names of up to five detected people registered in Face ID (845) will be displayed.



- Press the [▼] button several times until simple information display is activated, and then press the [◀][▶] buttons or turn the [DIAL] dial to choose an image.
- Names will be displayed on detected people.



- If you prefer not to have names displayed on images shot using Face ID, choose MENU (829) > [▶] tab > [Face ID Info] > [Name Display] > [Off].

Before Use

Basic Guide

Advanced Guide

Camera Basics

Auto Mode /
Hybrid Auto Mode

Other Shooting Modes

P Mode

Tv, Av, and M Mode

Playback Mode

Wireless Features

Setting Menu

Accessories

Appendix

Index

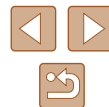

Browsing and Filtering Images

Navigating through Images in an Index

► Still Images ► Movies

By displaying multiple images in an index, you can quickly find the images you are looking for.

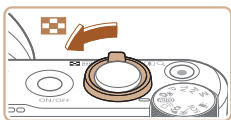

1 Display images in an index.

- Move the zoom lever toward to display images in an index. Moving the lever again will increase the number of images shown.
- To display fewer images, move the zoom lever toward . Fewer images are shown each time you move the lever.



2 Choose an image.

- Turn the dial to scroll through the images.
- Press the buttons to choose an image.
- An orange frame is displayed around the selected image.
- Press the button to view the selected image in single-image display.



- To deactivate the 3D display effect (shown if you hold down the buttons or turn the dial rapidly), choose MENU 29 > > [Index Effect] > [Off].

Finding Images Matching Specified Conditions

► Still Images ► Movies

Find desired images quickly on a memory card full of images by filtering image display according to your specified conditions. You can also protect 96 or delete 98 these images all at once.

Name	Displays images of a registered person 46).
People	Displays images with detected faces.
Shot Date	Displays the images shot on a specific date.
Favorites	Displays images tagged as favorites 101).
Still image/Movie	Displays still images, movies, or movies shot in mode 35).

1 Choose a search condition.

- Press the button, choose in the menu, and choose a condition 28).
- When you have selected , , or , choose the condition by pressing the buttons on the screen displayed, and then press the button.

2 View the filtered images.

- Images matching your conditions are displayed in yellow frames. To view only these images, press the buttons, or turn the dial.
- To cancel filtered display, choose in step 1.

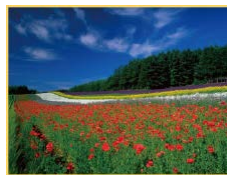

- When the camera has found no corresponding images for some conditions, those conditions will not be available.

Before Use

Basic Guide

Advanced Guide

Camera Basics

Auto Mode /
Hybrid Auto Mode

Other Shooting Modes

P Mode

Tv, Av, and M Mode

Playback Mode

Wireless Features

Setting Menu

Accessories

Appendix

Index





- To show or hide information, press the [▼] button in step 2.
- Options for viewing the images found (in step 2) include “Navigating through Images in an Index” (191), “Magnifying Images” (194), and “Viewing Slideshows” (194). You can also apply image operations to all images found, by choosing [Protect All Images in Search] in “Protecting Images” (196) or [Select All Images in Search] in “Erasing Multiple Images at Once” (198), “Adding Images to the Print List (DPOF)” (161), or “Adding Images to a Photobook” (163).
- If you edit images and save them as new images (102 – 106), a message is displayed, and the images that were found are no longer shown.

Viewing Individual Images in a Group

► Still Images ► Movies

Images shot continuously (44, 59, 80) and images shot in [C] mode (56) are grouped, and only the first image is displayed. However, you can also view the images individually.



1 Choose a grouped image.

- Press the [◀][▶] buttons or turn the [DIAL] dial to choose an image labeled with [SET].



2 Choose [Group Images].

- Press the [MENU] button, and then choose [Group Images] in the menu (28).



3 View images in the group individually.

- Pressing the [◀][▶] buttons or turning the [DIAL] dial will display only images in the group.
- To cancel group playback, press the [STOP] button, choose [Exit] in the menu, and press the [STOP] button again (28).



- During group playback (step 3), you can browse through images quickly “Navigating through Images in an Index” (91) and magnify them “Magnifying Images” (94). You can apply your actions to all images in the group at once by choosing [Protect All Images in Group] in “Protecting Images” (96), [All Images in Group] in “Erasing Multiple Images at Once” (98), [Select All in Group] in “Adding Images to the Print List (DPOF)” (161), or [Select All in Group] in “Adding Images to a Photobook” (163).
- To ungroup images so that they are displayed only as single still images, choose MENU (29) > [▶] tab > [Group Images] > [Off]. However, grouped images cannot be ungrouped during individual playback.
- Simultaneous display in [C] mode as described in step 2 of “Enjoying a Variety of Images from Each Shot” (56) is only shown immediately after you shoot.

Before Use
Basic Guide
Advanced Guide
Camera Basics
Auto Mode / Hybrid Auto Mode
Other Shooting Modes
P Mode
Tv, Av, and M Mode
Playback Mode
Wireless Features
Setting Menu
Accessories
Appendix
Index



Editing Face ID Information

If you notice that a name is incorrect during playback, you can change it or erase it.

However, you cannot add names for people who are not detected by Face ID (names are not displayed), and for people whose names have been erased.

Changing Names

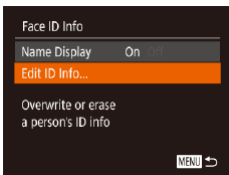

1 Access the setting screen.

- Press the [MENU] button and choose [Face ID Info] on the [DIAL] tab (📖29).
- Press the [▲][▼] buttons or turn the [DIAL] dial to choose [Edit ID Info], and then press the [OK] button.

2 Choose an image.

- Following the procedure in “Checking People Detected in Face ID” (📖90), choose an image and press the [OK] button.
- An orange frame is displayed around the selected face. When multiple names are displayed in an image, press the [◀][▶] buttons or turn the [DIAL] dial to choose the name to change, and then press the [OK] button.

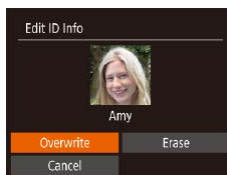

3 Choose the editing option.

- Press the [▲][▼][◀][▶] buttons or turn the [DIAL] dial to choose [Overwrite], and then press the [OK] button.

4 Choose the name of the person to overwrite with.

- Follow step 2 in “Overwriting and Adding Face Information” (📖48) to choose the name of the person you want to overwrite with.

Erasing Names

- On the screen displayed in step 3 in “Changing Names” (📖93), choose [Erase] and press the [OK] button.
- After [Erase?] is displayed, press the [◀][▶] buttons or turn the [DIAL] dial to choose [OK], and then press the [OK] button.

Before Use

Basic Guide

Advanced Guide

Camera Basics

Auto Mode /
Hybrid Auto Mode

Other Shooting Modes

P Mode

Tv, Av, and M Mode

Playback Mode

Wireless Features

Setting Menu

Accessories

Appendix

Index

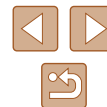
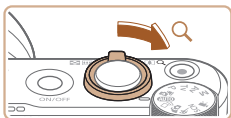

Image Viewing Options

Magnifying Images

► Still Images ► Movies



(1)

1 Magnify an image.

- Moving the zoom lever toward [Q] will zoom in and magnify the image. You can magnify images up to about 10x by continuing to hold the zoom lever.
- The approximate position of the displayed area (1) is shown for reference.
- To zoom out, move the zoom lever toward [R]. You can return to single-image display by continuing to hold it.

2 Move the display position and switch images as needed.

- To move the display position, press the [▲][▼][◀][▶] buttons.
- To switch to other images while zoomed, turn the [DISP.] dial.



- You can return to single-image display from magnified display by pressing the [MENU] button.

Viewing Slideshows

► Still Images ► Movies

Automatically play back images from a memory card as follows. Each image is displayed for about three seconds.



- Press the [DISP.] button, choose [S] in the menu, and choose the desired option ([28]).
- The slideshow will start after [Loading image] is displayed for a few seconds.
- Press the [MENU] button to stop the slideshow.



- The camera's power-saving functions ([26]) are deactivated during slideshows.



- To pause or resume slideshows, press the [DISP.] button.
- You can switch to other images during playback by pressing the [◀][▶] buttons or turning the [DISP.] dial. For fast-forward or fast-rewind, hold the [◀][▶] buttons down.
- In filtered display ([91]), only images matching search conditions are played.

Before Use

Basic Guide

Advanced Guide

Camera Basics

Auto Mode /
Hybrid Auto Mode

Other Shooting Modes

P Mode

Tv, Av, and M Mode

Playback Mode

Wireless Features

Setting Menu

Accessories

Appendix

Index



Changing Slideshow Settings

You can set up slideshows to repeat, and you can change the transitions between images and the display duration of each image.



1 Access the setting screen.

- Press the [MENU] button, and then choose [Slideshow] on the [▶] tab (📖29).

2 Configure the setting.

- Choose a menu item to configure, and then choose the desired option (📖29).
- To start the slideshow with your settings, choose [Start] and press the [⏪] button.
- To return to the menu screen, press the [MENU] button.

Auto Playback of Related Images (Smart Shuffle)

▶ Still Images ▶ Movies

Based on the current image, the camera offers four images that you may wish to view. After you choose to view one of those images, the camera offers four more images. This is an enjoyable way to play back images in an unexpected order. Try this feature after you have taken many shots, in many kinds of scenes.

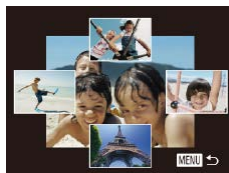

1 Choose Smart Shuffle.

- Press the [Ⓜ] button, and then choose [▶] in the menu (📖28).
- Four candidate images are displayed.

2 Choose an image.

- Press the [▲][▼][◀][▶] buttons to choose the image you want to view next.
- Your chosen image is displayed in the center, surrounded by the next four candidate images.
- For full-screen display of the center image, press the [Ⓜ] button. To restore the original display, press the [Ⓜ] button again.
- Press the [MENU] button to restore single-image display.



- Smart Shuffle is not available in the following cases:
 - There are less than 50 shots taken with this camera
 - An unsupported image is currently displayed
 - Images are shown in filtered display (📖91)
 - During group playback (📖92)

Before Use

Basic Guide

Advanced Guide

Camera Basics

Auto Mode /
Hybrid Auto Mode

Other Shooting Modes

P Mode

Tv, Av, and M Mode

Playback Mode

Wireless Features

Setting Menu

Accessories

Appendix

Index



Protecting Images

► Still Images ► Movies

Protect important images to prevent accidental erasure (📖98).

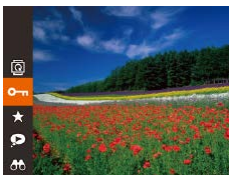

- Press the [🔒] button, and then choose [🔒] in the menu (📖28). [Protected] is displayed.
- To cancel protection, repeat this process and choose [🔒] again, and then press the [🔒] button.



- Protected images on a memory card will be erased if you format the card (📖146).



- Protected images cannot be erased using the camera's erasure function. To erase them this way, first cancel protection.

Using the Menu

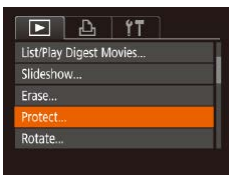

1 Access the setting screen.

- Press the [MENU] button and choose [Protect] on the [📷] tab (📖29).

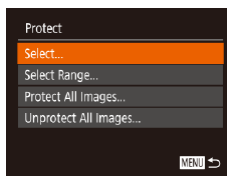

2 Choose a selection method.

- Choose an option as desired (📖29).
- To return to the menu screen, press the [MENU] button.

Choosing Images Individually

1 Choose [Select].

- Following step 2 in "Using the Menu" (📖96), choose [Select] and press the [🔒] button.



2 Choose an image.

- Press the [◀][▶] buttons or turn the [🔒] dial to choose an image, and then press the [🔒] button. [🔒] is displayed.
- To cancel selection, press the [🔒] button again. [🔒] is no longer displayed.
- Repeat this process to specify other images.

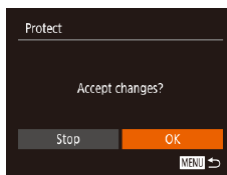

3 Protect the image.

- Press the [MENU] button. A confirmation message is displayed.
- Press the [◀][▶] buttons or turn the [🔒] dial to choose [OK], and then press the [🔒] button.



- Images will not be protected if you switch to Shooting mode or turn the camera off before finishing the setup process in step 3.

Before Use
Basic Guide
Advanced Guide
Camera Basics
Auto Mode / Hybrid Auto Mode
Other Shooting Modes
P Mode
Tv, Av, and M Mode
Playback Mode
Wireless Features
Setting Menu
Accessories
Appendix
Index



Selecting a Range

1 Choose [Select Range].

- Following step 2 in “Using the Menu” (p.96), choose [Select Range] and press the [MENU] button.

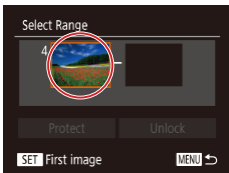

2 Choose a starting image.

- Press the [MENU] button.



- Press the [◀][▶] buttons or turn the [DISP.] dial to choose an image, and then press the [MENU] button.

3 Choose an ending image.

- Press the [▶] button to choose [Last image], and then press the [MENU] button.

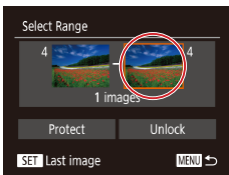

- Press the [◀][▶] buttons or turn the [DISP.] dial to choose an image, and then press the [MENU] button.
- Images before the first image cannot be selected as the last image.

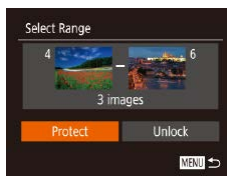

4 Protect the images.

- Press the [▼] button to choose [Protect], and then press the [MENU] button.



- You can also choose the first or last image by turning the [DISP.] dial when the top screen in steps 2 and 3 is displayed.
- To cancel protection for groups of images, choose [Unlock] in step 4.

Protecting All Images at Once

1 Choose [Protect All Images].

- Following step 2 in “Using the Menu” (p.96), choose [Protect All Images] and press the [MENU] button.

2 Protect the images.

- Press the [◀][▶] buttons or turn the [DISP.] dial to choose [OK], and then press the [MENU] button.

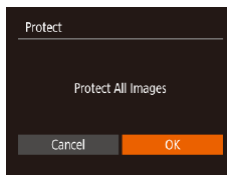

■ Clearing All Protection at Once

You can clear protection from all images at once. To clear protection, choose [Unprotect All Images] in step 1 of “Protecting All Images at Once”, and then complete step 2.

Before Use

Basic Guide

Advanced Guide

Camera Basics

Auto Mode /
Hybrid Auto Mode

Other Shooting Modes

P Mode

Tv, Av, and M Mode

Playback Mode

Wireless Features

Setting Menu

Accessories

Appendix

Index



Erasing Images

► Still Images ► Movies

You can choose and erase unneeded images one by one. Be careful when erasing images, because they cannot be recovered. However, protected images (📖96) cannot be erased.

1 Choose an image to erase.

- Press the [◀][▶] buttons or turn the [🔘] dial to choose an image.



2 Erase the image.

- Press the [📄] button.
- After [Erase?] is displayed, press the [◀][▶] buttons or turn the [🔘] dial to choose [Erase], and then press the [📄] button.
- The current image is now erased.
- To cancel erasure, press the [◀][▶] buttons or turn the [🔘] dial to choose [Cancel], and then press the [📄] button.

Erasing Multiple Images at Once

You can choose multiple images to erase at once. Be careful when erasing images, because they cannot be recovered. However, protected images (📖96) cannot be erased.

Choosing a Selection Method

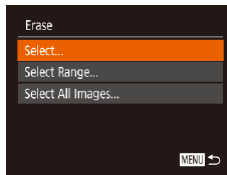
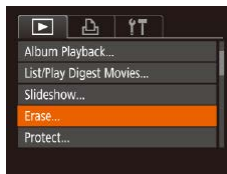

1 Access the setting screen.

- Press the [MENU] button, and then choose [Erase] on the [▶] tab (📖29).

2 Choose a selection method.

- Choose the desired item (📖29).
- To return to the menu screen, press the [MENU] button.

Before Use

Basic Guide

Advanced Guide

Camera Basics

Auto Mode /
Hybrid Auto Mode

Other Shooting Modes

P Mode

Tv, Av, and M Mode

Playback Mode

Wireless Features

Setting Menu

Accessories

Appendix

Index



Choosing Images Individually

1 Choose [Select].

- Following step 2 in “Choosing a Selection Method” (📖98), choose [Select] and press the [OK] button.



2 Choose an image.

- Once you choose an image following step 2 in “Choosing Images Individually” (📖96), [✓] is displayed.
- To cancel selection, press the [OK] button again. [✓] is no longer displayed.
- Repeat this process to specify other images.

3 Erase the images.

- Press the [MENU] button. A confirmation message is displayed.
- Press the [◀][▶] buttons or turn the [DIAL] dial to choose [OK], and then press the [OK] button.

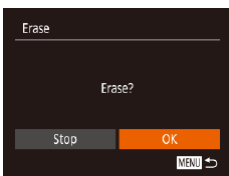

Selecting a Range

1 Choose [Select Range].

- Following step 2 in “Choosing a Selection Method” (📖98), choose [Select Range] and press the [OK] button.

2 Choose images.

- Follow steps 2 – 3 in “Selecting a Range” (📖97) to specify images.

3 Erase the images.

- Press the [▼] button to choose [Erase], and then press the [OK] button.

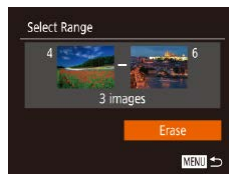

Specifying All Images at Once

1 Choose [Select All Images].

- Following step 2 in “Choosing a Selection Method” (📖98), choose [Select All Images] and press the [OK] button.

2 Erase the images.

- Press the [◀][▶] buttons or turn the [DIAL] dial to choose [OK], and then press the [OK] button.

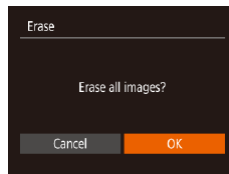

Before Use

Basic Guide

Advanced Guide

Camera Basics

Auto Mode /
Hybrid Auto Mode

Other Shooting Modes

P Mode

Tv, Av, and M Mode

Playback Mode

Wireless Features

Setting Menu

Accessories

Appendix

Index



Rotating Images

► Still Images ► Movies

Change the orientation of images and save them as follows.



1 Choose [Rotate].

- Press the [MENU] button, and then choose [Rotate] in the menu (📖28).



2 Rotate the image.

- Press the [◀] or [▶] button, depending on the desired direction. Each time you press the button, the image is rotated 90°. Press the [MENU] button to complete the setting.



- Rotation is not possible when [Auto Rotate] is set to [Off] (📖100).

Using the Menu

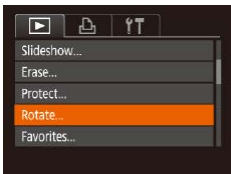

1 Choose [Rotate].

- Press the [MENU] button and choose [Rotate] on the [▶] tab (📖29).



2 Rotate the image.

- Press the [◀] or [▶] buttons or turn the [DISP] dial to choose an image.
- The image is rotated 90° each time you press the [MENU] button.
- To return to the menu screen, press the [MENU] button.

Deactivating Auto Rotation

Follow these steps to deactivate automatic image rotation, which rotates images based on the current camera orientation.

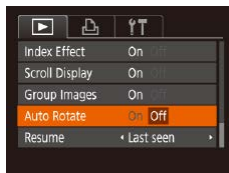

- Press the [MENU] button, choose [Auto Rotate] on the [▶] tab, and then choose [Off] (📖29).



- Images cannot be rotated (📖100) when you set [Auto Rotate] to [Off]. Additionally, images already rotated will be displayed in the original orientation.
- In Smart Shuffle (📖95) mode, even if [Auto Rotate] is set to [Off], images shot vertically will be displayed vertically, and rotated images will be displayed in the rotated orientation.

Before Use

Basic Guide

Advanced Guide

Camera Basics

Auto Mode /
Hybrid Auto Mode

Other Shooting Modes

P Mode

Tv, Av, and M Mode

Playback Mode

Wireless Features

Setting Menu

Accessories

Appendix

Index

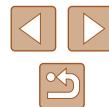

Tagging Images as Favorites

► Still Images ► Movies

You can organize images by tagging them as favorites. By choosing a category in filtered playback, you can restrict the following operations to all of those images.

- “Viewing” (📖87), “Viewing Slideshows” (📖94), “Protecting Images” (📖96), “Erasing Images” (📖98), “Adding Images to the Print List (DPOF)” (📖161), “Adding Images to a Photobook” (📖163)

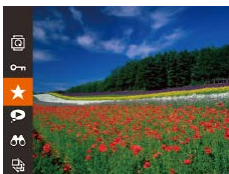

- Press the [MENU] button, and then choose [★] in the menu (📖28).
- [Tagged as Favorite] is displayed.
- To untag the image, repeat this process and choose [★] again, and then press the [MENU] button.

Using the Menu

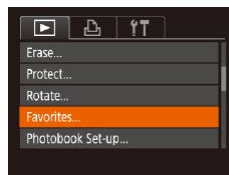

1 Choose [Favorites].

- Press the [MENU] button and choose [Favorites] on the [▶] tab (📖29).



2 Choose an image.

- Press the [◀][▶] buttons or turn the [DISP.] dial to choose an image, and then press the [MENU] button. [★] is displayed.
- To untag the image, press the [MENU] button again. [★] is no longer displayed.
- Repeat this process to choose additional images.

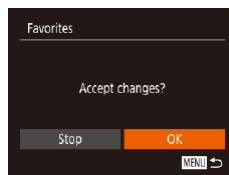

3 Finish the setup process.

- Press the [MENU] button. A confirmation message is displayed.
- Press the [◀][▶] buttons or turn the [DISP.] dial to choose [OK], and then press the [MENU] button.



- Images will not be tagged as favorites if you switch to Shooting mode or turn the camera off before finishing the setup process in step 3.



- Tagging images as favorites makes it easier to add them when creating albums (📖108).

Before Use

Basic Guide

Advanced Guide

Camera Basics

Auto Mode /
Hybrid Auto Mode

Other Shooting Modes

P Mode

Tv, Av, and M Mode

Playback Mode

Wireless Features

Setting Menu

Accessories

Appendix

Index



Editing Still Images



- Image editing (📖102 – 📖104) is only available when the memory card has sufficient free space.

Resizing Images

▶ Still Images ▶ Movies

Save a copy of images at a lower number of recording pixels.

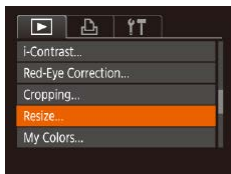

1 Choose [Resize].

- Press the [MENU] button and choose [Resize] on the [▶] tab (📖29).

2 Choose an image.

- Press the [◀][▶] buttons or turn the [🔍] dial to choose an image, and then press the [⏏] button.

3 Choose an image size.

- Press the [◀][▶] buttons or turn the [🔍] dial to choose the size, and then press the [⏏] button.
- [Save new image?] is displayed.



4 Save the new image.

- Press the [◀][▶] buttons or turn the [🔍] dial to choose [OK], and then press the [⏏] button.
- The image is now saved as a new file.

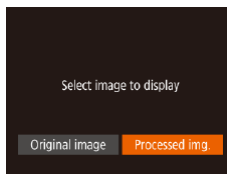

5 Review the new image.

- Press the [MENU] button.
- Press the [◀][▶] buttons or turn the [🔍] dial to choose [Processed img.], and then press the [⏏] button.
- The saved image is now displayed.



- Editing is not possible for images shot at a recording pixel setting of [S] (📖50).



- Images cannot be resized to a higher number of recording pixels.
- Choosing [Original image] in step 5 will display the original image.

Cropping

▶ Still Images ▶ Movies

You can specify a portion of an image to save as a separate image file.

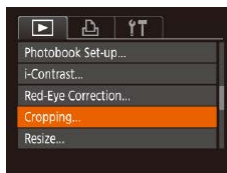

1 Choose [Cropping].

- Press the [MENU] button, and then choose [Cropping] on the [▶] tab (📖29).

Before Use
Basic Guide
Advanced Guide
Camera Basics
Auto Mode / Hybrid Auto Mode
Other Shooting Modes
P Mode
Tv, Av, and M Mode
Playback Mode
Wireless Features
Setting Menu
Accessories
Appendix
Index



2 Choose an image.

- Press the [◀][▶] buttons or turn the [🔍] dial to choose an image, and then press the [Ⓜ] button.

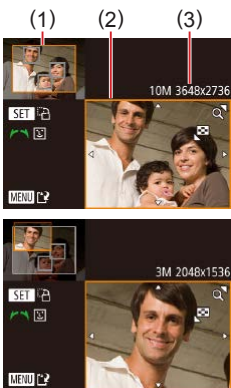

3 Adjust the cropping area.

- A frame is displayed around the portion of the image to be cropped (1).
- The original image is shown in the upper left, and a preview of the image as cropped (2) is shown in the lower right. You can also see the number of recording pixels after cropping (3).
- To resize the frame, move the zoom lever.
- To move the frame, press the [▲][▼][◀][▶] buttons.
- To change the frame orientation, press the [Ⓜ] button.
- Faces detected in the image are enclosed in gray frames in the upper-left image. Turn the [🔍] dial to switch frames, which position the cropping area.
- Press the [MENU] button.

4 Save as a new image and review.

- Follow steps 4 – 5 in “Resizing Images” (📖102).



- Editing is not possible for images shot at a recording pixel setting of [S] (📖50) or resized to [S] (📖102).



- Images supported for cropping will have the same aspect ratio after cropping.
- Cropped images will have a lower number of recording pixels than uncropped images.
- If you crop still images shot using Face ID (📖45), only the names of the people left in the cropped image will remain.

Changing Image Color Tones (My Colors)

▶ Still Images ▶ Movies

You can adjust image colors and then save the edited image as a separate file. For details on each option, see “Changing Image Color Tones (My Colors)” (📖74).



1 Choose [My Colors].

- Press the [MENU] button, and then choose [My Colors] on the [▶] tab (📖29).

2 Choose an image.

- Press the [◀][▶] buttons or turn the [🔍] dial to choose an image, and then press the [Ⓜ] button.

3 Choose an option.

- Press the [◀][▶] buttons or turn the [🔍] dial to choose an option, and then press the [Ⓜ] button.



4 Save as a new image and review.

- Follow steps 4 – 5 in “Resizing Images” (📖102).

Before Use
Basic Guide
Advanced Guide
Camera Basics
Auto Mode / Hybrid Auto Mode
Other Shooting Modes
P Mode
Tv, Av, and M Mode
Playback Mode
Wireless Features
Setting Menu
Accessories
Appendix
Index





- Image quality of pictures you repeatedly edit this way will be a little lower each time, and you may not be able to obtain the desired color.



- The color of images edited using this function may vary slightly from the color of images shot using My Colors (174).

Correcting Image Brightness (i-Contrast)

► Still Images ► Movies

Excessively dark image areas (such as faces or backgrounds) can be detected and automatically adjusted to the optimal brightness. Insufficient overall image contrast is also automatically corrected, to make subjects stand out better. Choose from four correction levels, and then save the image as a separate file.

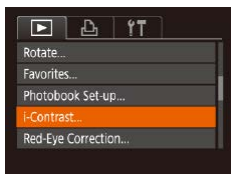

1 Choose [i-Contrast].

- Press the [MENU] button, and then choose [i-Contrast] on the [] tab (129).

2 Choose an image.

- Press the [◀][▶] buttons or turn the [] dial to choose an image, and then press the [] button.



3 Choose an option.

- Press the [◀][▶] buttons or turn the [] dial to choose an option, and then press the [] button.

4 Save as a new image and review.

- Follow steps 4 – 5 in “Resizing Images” (102).



- For some images, correction may be inaccurate or may cause images to appear grainy.
- Images may look grainy after repeated editing using this function.



- If [Auto] does not produce the expected results, try correcting images using [Low], [Medium], or [High].

Correcting Red-Eye

► Still Images ► Movies

Automatically corrects images affected by red-eye. You can save the corrected image as a separate file.

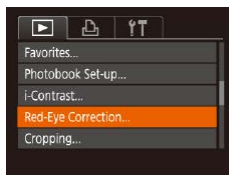

1 Choose [Red-Eye Correction].

- Press the [MENU] button, and then choose [Red-Eye Correction] on the [] tab (129).

Before Use
Basic Guide
Advanced Guide
Camera Basics
Auto Mode / Hybrid Auto Mode
Other Shooting Modes
P Mode
Tv, Av, and M Mode
Playback Mode
Wireless Features
Setting Menu
Accessories
Appendix
Index



2 Choose an image.

- Press the [◀][▶] buttons or turn the [DISC] dial to choose an image.

3 Correct the image.

- Press the [DISC] button.
- Red-eye detected by the camera is now corrected, and frames are displayed around corrected image areas.
- Enlarge or reduce images as needed. Follow the steps in “Magnifying Images” (104).



4 Save as a new image and review.

- Press the [▲][▼][◀][▶] buttons or turn the [DISC] dial to choose [New File], and then press the [DISC] button.
- The image is now saved as a new file.
- Follow step 5 in “Resizing Images” (102).



- Some images may not be corrected accurately.
- To overwrite the original image with the corrected image, choose [Overwrite] in step 4. In this case, the original image will be erased.
- Protected images cannot be overwritten.

Editing Movies

► Still Images ► Movies

You can remove unneeded portions from the beginning and end of movies (excluding digest movies, 35).

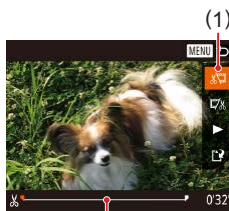
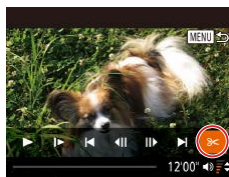

1 Choose [F7].

- Following steps 1 – 5 in “Viewing” (87), choose [F7] and press the [DISC] button.
- The movie editing panel and editing bar are now displayed.

2 Specify portions to cut.

- (1) is the movie editing panel, and (2) is the editing bar.
- Press the [▲][▼] buttons to choose [L] or [R].
- To view the portions you can cut (identified by [L] on the screen), press the [◀][▶] buttons or turn the [DISC] dial to move [L]. Cut the beginning of the movie (from [L]) by choosing [L], and cut the end of the movie by choosing [R].
- If you move [L] to a position other than a [L] mark, in [L] the portion before the nearest [L] mark on the left will be cut, while in [R] the portion after the nearest [L] mark on the right will be cut.

Before Use
Basic Guide
Advanced Guide
Camera Basics
Auto Mode / Hybrid Auto Mode
Other Shooting Modes
P Mode
Tv, Av, and M Mode
Playback Mode
Wireless Features
Setting Menu
Accessories
Appendix
Index

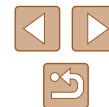

3 Review the edited movie.

- Press the [▲][▼] buttons to choose [▶], and then press the [Ⓜ] button. The edited movie is now played.
- To edit the movie again, repeat step 2.
- To cancel editing, press the [MENU] button, choose [OK] (either press the [◀][▶] buttons or turn the [Ⓜ] dial), and then press the [Ⓜ] button.

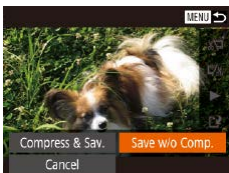
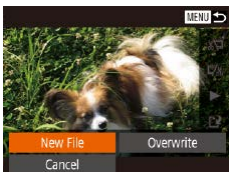

4 Save the edited movie.

- Press the [▲][▼] buttons to choose [▶], and then press the [Ⓜ] button.
- Press the [▲][▼][◀][▶] buttons or turn the [Ⓜ] dial to choose [New File], and then press the [Ⓜ] button.
- Choose [Save w/o Comp.], and then press the [Ⓜ] button.
- The movie is now saved as a new file.



- To overwrite the original movie with the cut one, choose [Overwrite] in step 4. In this case, the original movie will be erased.
- If the memory card lacks sufficient space, only [Overwrite] will be available.
- Movies may not be saved if the battery pack runs out while saving is in progress.
- When editing movies, you should use a fully charged battery pack.

Reducing File Sizes

Movie file sizes can be reduced by compressing movies as follows.



- On the screen in step 2 of “Editing Movies”, choose [▶]. Choose [New File], and then press the [Ⓜ] button.
- Choose [Compress & Sav.], and then press the [Ⓜ] button.



- Compressed movies are saved in [HD 30P] format.
- [VGA 30P] movies cannot be compressed.
- Edited movies cannot be saved in compressed format when you choose [Overwrite].

Before Use

Basic Guide

Advanced Guide

Camera Basics

Auto Mode /
Hybrid Auto Mode

Other Shooting Modes

P Mode

Tv, Av, and M Mode

Playback Mode

Wireless Features

Setting Menu

Accessories

Appendix

Index



Erasing Movie Chapters

► Still Images ► Movies

Individual chapters (clips) (📖35, 📖57) recorded in [📺] or [📷] mode can be erased. Be careful when erasing clips, because they cannot be recovered.



1 Select the clip to erase.

- Play a short movie as described in steps 1 – 2 of “Viewing Short Movies Recorded in Creative Shot Mode (Creative Shot Movies)” (📖89) or “Viewing Short Movies Created When Shooting Still Images (Digest Movies)” (📖90), and then press the [📺] button to access the movie control panel.
- To choose the clip, press the [⏪][⏩] buttons or turn the [🔘] dial to choose [⏪] or [⏩], and then press the [📺] button.

2 Choose [📷].

- Press the [⏪][⏩] buttons or turn the [🔘] dial to choose [📷], and then press the [📺] button.
- The selected clip is played back repeatedly.

3 Confirm erasure.

- Press the [⏪][⏩] buttons or turn the [🔘] dial to choose [OK], and then press the [📺] button.
- The clip is erased, and the short movie is overwritten.

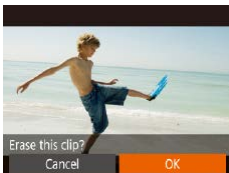

- Albums with background music (📖109) cannot be edited.
- [📷] is not displayed if you select a clip when the camera is connected to a printer.

Before Use

Basic Guide

Advanced Guide

Camera Basics

Auto Mode /
Hybrid Auto Mode

Other Shooting Modes

P Mode

Tv, Av, and M Mode

Playback Mode

Wireless Features

Setting Menu

Accessories

Appendix

Index



Viewing Albums (Story Highlights)

► Still Images ► Movies

You can choose themes such as a date or person's name to create an album of automatically selected images that match the theme. These images are combined into a slideshow that can be saved as a short movie of about 2 – 3 minutes.

Before using this feature, make sure the battery pack is fully charged. Creating albums also requires free space on the memory card. As a guideline, use a memory card with a capacity of 16 GB or higher, and ensure at least 1 GB of free space.

Choosing Themes for Albums

Press the [▲] button to access the home screen and choose themes for the camera to use when selecting album elements. Note that the camera is more likely to add images tagged as favorites (📖101) to albums.

Date	Creates an album of images shot on the same day. Images are selected from those shot on the same day as the image displayed before you access the home screen.
Person's name	Can be used to create monthly albums of people, such as albums of children as they grow up. Subjects whose Face ID information you registered before shooting may be selected for albums. Images selected are those that have the same subject shot during the same month as the image displayed before you access the home screen.
Event	A good choice for albums of vacations, parties, or other events. Images are selected from those shot during the event before and after the image displayed before you access the home screen.
Custom	Includes images based on your specified images, dates, or people registered in Face ID.

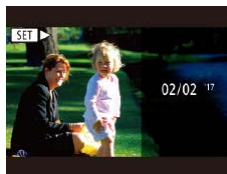
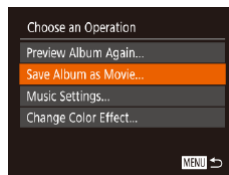

1 Choose an image.

- Choose an image in single-image display.
- Themes available in step 3 will vary depending on image shooting date and Face ID information.

2 Access the home screen.

- Press the [▲] button.
- After [Busy] is displayed, the home screen is displayed.

3 Preview an album.

- Choose a person, [Date], or [Event] (either press the [◀][▶] buttons or turn the [🔘] dial) as the album theme, and then press the [📖] button.
- After [Loading] is displayed for a few seconds, the album is played.

4 Save the album.

- Press the [▲][▼] buttons or turn the [🔘] dial to choose [Save Album as Movie], and then press the [📖] button.
- Once the album is saved, [Saved] is displayed.

5 Play the album (📖87).

Before Use
Basic Guide
Advanced Guide
Camera Basics
Auto Mode / Hybrid Auto Mode
Other Shooting Modes
P Mode
Tv, Av, and M Mode
Playback Mode
Wireless Features
Setting Menu
Accessories
Appendix
Index

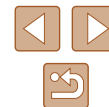



- Albums can include following images captured by the camera.
 - Still images
 - Digest movies (📖35)
 - Short movie clips (📖69) of two seconds or longer, or Creative Shot movies (📖57), except compressed movies



- Albums cannot be saved unless there is enough space on the memory card.
- To jump to the next chapter during the preview, press the [▶] button, and to jump to the previous chapter, press the [◀] button.
- You can specify the color effect in step 4 by choosing [Change Color Effect] and pressing the [🎨] button. To preview how the album looks with your selected effect applied, choose [Preview Album Again] on the screen in step 4 after pressing the [◀][▶] buttons to choose a color effect and pressing the [🎨] button.
- To play saved albums, choose [List of Albums] on the Story Highlights home screen, press the [🎧] button, choose a listed album, and press the [🎧] button again.

Adding Background Music to Albums

▶ Still Images ▶ Movies

Choose from seven kinds of background music to play during album playback.

1 Register background music to a memory card.

- Following steps 1 – 4 in “Viewing Albums (Story Highlights)” (📖108), choose [Music Settings] and press the [🎧] button.

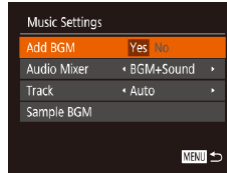
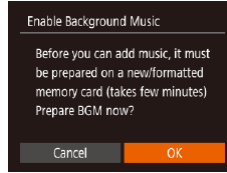

- The screen at left is displayed when you use a new or recently formatted memory card. Choose [OK], press [🎧], and wait until the seven types of music are registered to the card, which takes about four minutes.
- When using a memory card with music already registered to it, go to step 2.

2 Create the album.

- Follow steps 1 – 3 in “Viewing Albums (Story Highlights)” (📖108) to create an album.

3 Configure background music settings.

- Choose an item, press the [🎧] button, and choose an option (📖29).

4 Save the album.

- Follow step 4 in “Viewing Albums (Story Highlights)” (📖108) to save albums.



- Once albums are saved, background music cannot be added later. Background music in albums cannot be removed or changed.
- Chapters of albums with background music cannot be edited (📖107).

- Before Use
- Basic Guide
- Advanced Guide
 - Camera Basics
 - Auto Mode / Hybrid Auto Mode
 - Other Shooting Modes
 - P Mode
 - Tv, Av, and M Mode
 - Playback Mode
 - Wireless Features
 - Setting Menu
 - Accessories
 - Appendix
 - Index

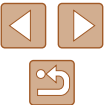



- If you prefer not to add background music, set [Add BGM] to [No] on the screen in step 3.
- To use only background music instead of movie audio, set [Audio Mixer] to [BGM only] on the screen in step 3.
- To listen to a sample of the background music selected in [Track], choose [Sample BGM] on the screen in step 3 and press the [OK] button.

Creating Your Own Albums

► Still Images ► Movies

Create your own albums by choosing desired images.

1 Choose to create a Custom album.

- Following steps 1 – 3 in “Viewing Albums (Story Highlights)” (108), choose [Custom] and press the [OK] button.

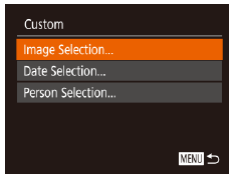

2 Choose a selection method.

- Choose [Image Selection], [Date Selection], or [Person Selection], and then press the [OK] button.

3 Choose album elements.

- Once you select the elements for your album and press the [OK] button, your selected elements are labeled with [✓].
- Press the [MENU] button after you finish selecting still images, short clips, or Creative Shot movies in [Image Selection], dates in [Date Selection], or people in [Person Selection].

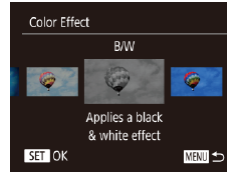
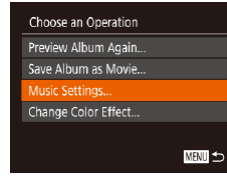

- Press the [◀][▶] buttons or turn the [DIAL] dial to choose [Preview], and then press the [OK] button.

4 Choose background music.

- When the screen at left is displayed, choose [Music Settings]. Add background music as described in “Adding Background Music to Albums” (109), and then press the [MENU] button.

5 Choose a color effect.

- On the screen in step 4 of “Viewing Albums (Story Highlights)” (108), choose [Change Color Effect].
- Press the [◀][▶] buttons to choose a color effect, and then press the [OK] button.

6 Save the album.

- Follow step 4 in “Viewing Albums (Story Highlights)” (108) to save albums.



- You can specify up to 40 files (or 10 movie files) after choosing [Image Selection]. The second time you create a custom album, [Select images based on previous settings?] is displayed. To use previously selected images as the basis, choose [Yes]. The previous stills, clips, or Creative Shot movies are labeled with [✓], and multiple images are displayed.
- Up to 15 dates can be selected if you choose [Date Selection].
- The color effect may not be applied to some images.

Before Use

Basic Guide

Advanced Guide

Camera Basics

Auto Mode /
Hybrid Auto Mode

Other Shooting Modes

P Mode

Tv, Av, and M Mode

Playback Mode

Wireless Features

Setting Menu

Accessories

Appendix

Index

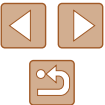

Combining Short Clips

► Still Images ► Movies

Combine short clips to create a longer movie.

Note that movies created this way are not included in Story Highlights albums (📖108).

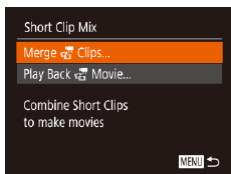

1 Access the editing screen.

- Press the [MENU] button, choose [Short Clip Mix] on the [▶] tab, and then choose [Merge Clips] (📖29).

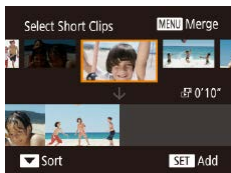

2 Specify clips to combine.

- Press the [◀][▶] buttons or turn the [🔍] dial to choose a clip on the top of the screen to combine, and then press the [⏻] button.
- Your selected clip is displayed on the bottom of the screen.
- To cancel selection, press the [⏻] button again.
- Repeat these steps to specify other clips to combine.
- After you are finished selecting clips, press the [MENU] button.

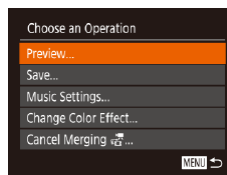

3 Preview the movie.

- Choose [Preview] and press the [⏻] button.
- After [Loading] is displayed for a few seconds, a preview of the combined clips is played.

4 Save the movie.

- Choose [Save], and then press the [⏻] button.
- Once the movie is saved, [Saved] is displayed.

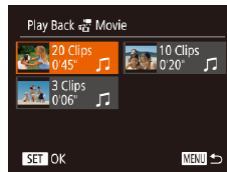

5 Play the movie.

- Choose [Play Back Movie] on the screen in step 1 to view a list of movies you have created.
- Choose the movie to play and press the [⏻] button.



- To play the selected clip, move the zoom lever toward [🔍] on the screen in step 2.
- To rearrange clips, press the [▼] button on the screen in step 2, select a clip, press the [⏻] button, press the [◀][▶] buttons or turn the [🔍] dial, and then press the [⏻] button again.
- To apply a color effect, choose [Change Color Effect] on the screen in step 3.
- To add background music, choose [Music Settings] on the screen in step 3 (📖109).
- The image quality of movies saved is [4K].
- Use a fully charged battery pack, if possible.

Before Use

Basic Guide

Advanced Guide

Camera Basics

Auto Mode / Hybrid Auto Mode

Other Shooting Modes

P Mode

Tv, Av, and M Mode

Playback Mode

Wireless Features

Setting Menu

Accessories

Appendix

Index



Wireless Features

Send images wirelessly from the camera to a variety of compatible devices, and use the camera with Web services



- Before using wireless features, be sure to read “Precautions for Wireless Features (Wi-Fi, Bluetooth, or Others)” (p.187).

Available Wireless Features

Using Wi-Fi Features

You can send and receive images and control the camera remotely by connecting it to these devices and services via Wi-Fi.

- **Smartphones and Tablets**
Send images to smartphones and tablet computers that have Wi-Fi functions. Remote live view shooting is also possible from a smartphone or tablet.
For convenience in this guide, smartphones, tablets, and other compatible devices are collectively referred to as “smartphones”.
- **Computer**
Use software to save camera images to a computer connected via Wi-Fi.
- **Web Services**
Add your account information to the camera for CANON iMAGE GATEWAY online photography service or other Web services to send camera images to the services. Unsent images on the camera can also be sent to a computer or Web service via CANON iMAGE GATEWAY.
- **Printers**
Send images wirelessly to a PictBridge-compatible printer (supporting DPS over IP) to print them.
- **Another Camera**
Send images wirelessly between Wi-Fi-compatible Canon cameras.

Using Bluetooth® Features

You can easily pair the camera with a smartphone featuring Bluetooth low energy technology*. You can also shoot, view, or geotag images by using your smartphone as a remote control.

* Hereafter referred to as “Bluetooth”.

Before Use

Basic Guide

Advanced Guide

Camera Basics

Auto Mode /
Hybrid Auto Mode

Other Shooting Modes

P Mode

Tv, Av, and M Mode

Playback Mode

Wireless Features

Setting Menu

Accessories

Appendix

Index



Sending Images to a Smartphone

There are several ways to connect the camera to a smartphone and send images.

- **Connect via Bluetooth**
You can easily connect the camera to a Bluetooth enabled smartphone by pairing them. This simplifies transferring images to a smartphone.
- **Connect via NFC** (📖115)
Simply touch an NFC-compatible Android smartphone against the camera to connect the devices.
- **Connect via the Wi-Fi menu** (📖117)
You can connect the camera to a smartphone as you would connect it to a computer or other device. Multiple smartphones can be added.

Before connecting to the camera, you must install the free dedicated Camera Connect app on the smartphone. For details on this application (supported smartphones and included functions), refer to the Canon website.



- Canon Wi-Fi-compatible camera owners who use CameraWindow to connect their camera via Wi-Fi to a smartphone should consider switching to the Camera Connect mobile app.

Transferring Images to a Bluetooth Enabled Smartphone

Once you have paired with a smartphone via Bluetooth, simply operate your smartphone to view and save camera images.



1 Install Camera Connect.

- For Android smartphones, find Camera Connect in Google Play and download and install the app.
- For an iPhone or iPad, find Camera Connect in the App Store and download and install the app.

2 Register a nickname.

- Press the power button.
- Press the [MENU] button, choose [Wireless settings] on the [🔑] tab, and then choose [Nickname].
- Press the [Ⓜ] button to access the keyboard (📖130), and then enter a nickname.
- To return to [Wireless settings] after pressing the [MENU] button, press the [MENU] button again.

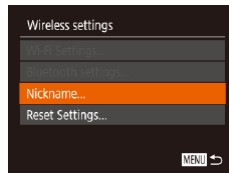

Before Use

Basic Guide

Advanced Guide

Camera Basics

Auto Mode /
Hybrid Auto Mode

Other Shooting Modes

P Mode

Tv, Av, and M Mode

Playback Mode

Wireless Features

Setting Menu

Accessories

Appendix

Index



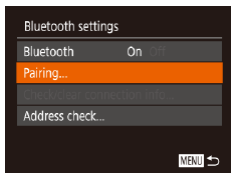

3 Prepare for pairing.

- Choose [Bluetooth settings], press the [▲][▼] buttons or turn the [DISP] dial to choose [Pairing], and then press the [DISP] button.

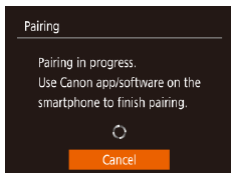

- A screen is displayed indicating that the camera is waiting to connect.



4 Start Camera Connect.

- Activate Bluetooth on the smartphone, and then start Camera Connect on the smartphone.
- After the camera is recognized, a camera selection screen is displayed.



5 Select the camera to connect to.

- Choose the camera nickname.
- Complete the pairing process for the smartphone.

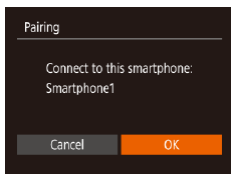

6 Complete pairing.

- Press the [◀][▶] buttons or turn the [DISP] dial to choose [OK] after the confirmation message on the camera, and then press the [DISP] button.

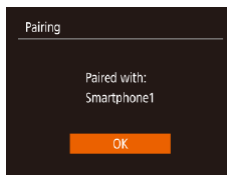

- Press the [DISP] button when the screen at left is displayed.

7 Transfer images.

- The camera will automatically switch to Wi-Fi if you choose [Images on camera] in Camera Connect.
- On an iPhone or iPad, in the device's Wi-Fi setting menu, choose the SSID (network name) displayed on the camera to establish a connection.
- Use the smartphone to transfer images from the camera to the smartphone.
- To switch to Bluetooth, disable the Wi-Fi connection on the smartphone.



- Battery life may be shorter when you use the camera after pairing, because power is consumed even when the camera is off.
- Before bringing the camera to places where the use of electronic devices is restricted, set [Bluetooth] to [Off], to avoid having the camera ready for Bluetooth communication even when it is off.

Before Use

Basic Guide

Advanced Guide

Camera Basics

Auto Mode / Hybrid Auto Mode

Other Shooting Modes

P Mode

Tv, Av, and M Mode

Playback Mode

Wireless Features

Setting Menu

Accessories

Appendix

Index





- Bluetooth connection status is indicated by one of the following icons.
- [📶] Connected, [🚫] Disconnected
- You can also use the camera to disable Wi-Fi connection described in step 7.
- To check the information of the smartphone connected via Bluetooth in [Check/clear connection info], choose MENU (📖29) > [📶] tab > [Wireless settings] > [Bluetooth settings]. Choose [Address check] to check the camera's Bluetooth address.

Transferring Images to an NFC-Compatible Smartphone

Use an Android smartphone's NFC to simplify the process of installing Camera Connect and connecting to the camera.

Operation when devices are initially connected via NFC varies depending on the camera mode when the devices are touched together.

- If the camera is off or in Shooting mode when the devices are touched together, you can choose and send images on the image selection screen. Once the devices are connected, you can also shoot remotely while viewing a shooting screen on the smartphone (📖136). It's easy to reconnect to recent devices, which are listed in the Wi-Fi menu.
- If the camera is in Playback mode when the devices are touched together, you can choose and send images from the index display shown for image selection.

Follow the instructions in the following section for NFC-initiated connection to a camera that is off or in Shooting mode.

Connecting via NFC When Camera Is Off or in Shooting Mode

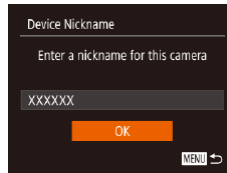
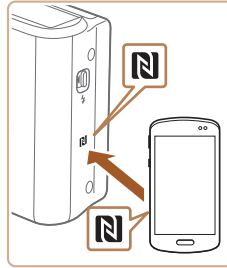

1 Install Camera Connect.

- Refer to the smartphone user manual to check where the N-Mark (N) is located.
- Activate NFC on the smartphone and touch the devices' N-Marks (N) together to start Google Play on the smartphone automatically. Once the Camera Connect download page is displayed, download and install the app.

2 Establish the connection.

- Make sure the camera is off or in Shooting mode.
- Touch the N-Mark (N) on the smartphone with Camera Connect installed against the camera's N-Mark.
- The camera screen automatically changes.
- If the [Device Nickname] screen is displayed, press the [▲][▼] buttons or turn the [🔍] dial to choose [OK], and then press the [📶] button.

- Camera Connect is started on the smartphone.
- The devices are connected automatically.

Before Use
Basic Guide
Advanced Guide
Camera Basics
Auto Mode / Hybrid Auto Mode
Other Shooting Modes
P Mode
Tv, Av, and M Mode
Playback Mode
Wireless Features
Setting Menu
Accessories
Appendix
Index

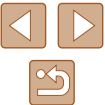

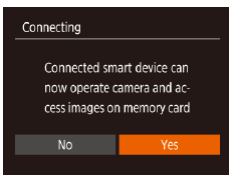

3 Adjust the privacy setting.

- When this screen is displayed, press the [◀][▶] buttons or turn the [DISP] dial to choose [Yes], and then press the [DISP] button.
- You can now use the smartphone for remote live view shooting, or to browse or transfer images on the camera.

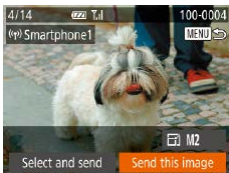

4 Send an image.

- Press the [▲][▼][◀][▶] buttons to choose [Send this image], and then press the [DISP] button.
- [Transfer completed] is displayed after the image is sent, and the image transfer screen is displayed again.
- To end the connection, press the [MENU] button, choose [OK] on the confirmation screen (either press the [◀][▶] buttons or turn the [DISP] dial), and then press the [DISP] button. You can also use the smartphone to end the connection.



- When using NFC, keep the following points in mind.
 - Avoid strong impact between the camera and smartphone. This may damage the devices.
 - Depending on the smartphone, the devices may not recognize each other immediately. In this case, try holding the devices together in slightly different positions. If connection is not established, keep the devices together until the camera screen is updated.
 - If you attempt connection when the camera is off, a message may be displayed on the smartphone reminding you to turn on the camera. If so, turn the camera on and touch the devices together again.
 - Do not place other objects between the camera and smartphone. Also, note that camera or smartphone covers or similar accessories may block communication.
- All images in the camera can be viewed from the connected smartphone when you choose [Yes] in step 3. To keep camera images private, so that they cannot be viewed from the smartphone, choose [No] in step 3.
- Once you have registered a smartphone, you can change privacy settings for it on the camera (139).



- Connections require that a memory card be in the camera.
- You can also change the camera nickname on the screen in step 2 (140).
- You can also send multiple images at once and change the image size before sending (132).
- To disable NFC connections, choose MENU (29) > [↑] tab > [Wireless settings] > [Wi-Fi Settings] > [NFC] > [Off].

Before Use
Basic Guide
Advanced Guide
Camera Basics
Auto Mode / Hybrid Auto Mode
Other Shooting Modes
P Mode
Tv, Av, and M Mode
Playback Mode
Wireless Features
Setting Menu
Accessories
Appendix
Index

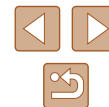

Connecting via NFC When Camera Is in Playback Mode



- Press the [▶] button to turn the camera on.
- Touch the smartphone with Camera Connect installed (115) against the camera's N-Mark (N).
- Press the [▲][▼][◀][▶] buttons or turn the [⦿] dial to choose an image to send, and then press the [Ⓢ] button. [✓] is displayed.
- To cancel selection, press the [Ⓢ] button again. [✓] is no longer displayed.
- Repeat this process to choose additional images.
- After you finish choosing images, press the [MENU] button.
- Press the [◀][▶] buttons to choose [OK], and then press the [Ⓢ] button.
- Press the [◀][▶] buttons or turn the [⦿] dial to choose [Send], and then press the [Ⓢ] button.
- The images are now sent.



- If during connection a message on the camera requests you to enter the nickname, follow step 2 in "Transferring Images to an NFC-Compatible Smartphone" (115) to enter it.
- The camera does not keep a record of smartphones you connect to via NFC in Playback mode.
- You can preset images to transfer at your desired size (132).

Adding a Smartphone Using the Wi-Fi Menu

These steps show how to use the camera as an access point, but you can also use an existing access point (119).

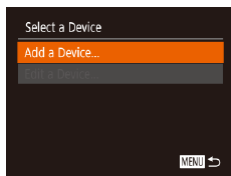
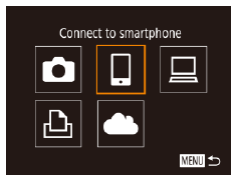
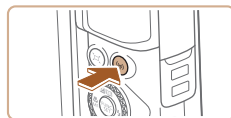

1 Install Camera Connect.

- For Android smartphones, find Camera Connect in Google Play and download and install the app.
- For an iPhone or iPad, find Camera Connect in the App Store and download and install the app.

2 Access the Wi-Fi menu.

- Press the [Wi-Fi] button.
- If the [Device Nickname] screen is displayed, choose [OK] (115).

3 Choose [Wi-Fi].

- Press the [▲][▼][◀][▶] buttons or turn the [⦿] dial to choose [Wi-Fi], and then press the [Ⓢ] button.

4 Choose [Add a Device].

- Press the [▲][▼] buttons or turn the [⦿] dial to choose [Add a Device], and then press the [Ⓢ] button.

Before Use
Basic Guide
Advanced Guide
Camera Basics
Auto Mode / Hybrid Auto Mode
Other Shooting Modes
P Mode
Tv, Av, and M Mode
Playback Mode
Wireless Features
Setting Menu
Accessories
Appendix
Index



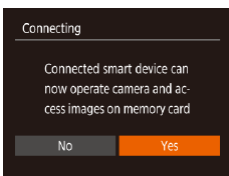
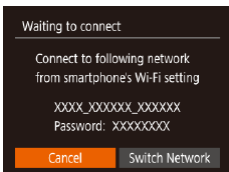

- The camera SSID and password are displayed.

5 Connect the smartphone to the network.

- In the smartphone's Wi-Fi setting menu, choose the SSID (network name) displayed on the camera to establish a connection.
- In the password field, enter the password displayed on the camera.

6 Start Camera Connect.

- Start Camera Connect on the smartphone.

7 Select the camera to connect to.

- On the camera selection screen displayed on the smartphone, choose the camera to begin pairing.

8 Adjust the privacy setting.

- Press the [◀][▶] buttons or turn the [DISP] dial to choose [Yes], and then press the [OK] button.
- You can now use the smartphone for remote live view shooting, or to browse or transfer images on the camera.



9 Send an image.

- Press the [▲][▼][◀][▶] buttons to choose [Select and send], and then press the [OK] button.
- Press the [▲][▼] buttons or turn the [DISP] dial to choose [Select], and then press the [OK] button.
- Press the [▲][▼][◀][▶] buttons or turn the [DISP] dial to choose an image to send, press the [OK] button to mark it as selected ([✓]), and then press the [MENU] button.
- Press the [◀][▶] buttons or turn the [DISP] dial to choose [OK], and then press the [OK] button.
- Press the [◀][▶] buttons or turn the [DISP] dial to choose [Send], and then press the [OK] button.
- [Transfer completed] is displayed after the image is sent, and the image transfer screen is displayed again.
- To end the connection, press the [MENU] button, choose [OK] on the confirmation screen (either press the [◀][▶] buttons or turn the [DISP] dial), and then press the [OK] button. You can also use the smartphone to end the connection.
- To add multiple smartphones, repeat the above procedure starting from step 1.

Before Use
Basic Guide
Advanced Guide
Camera Basics
Auto Mode / Hybrid Auto Mode
Other Shooting Modes
P Mode
Tv, Av, and M Mode
Playback Mode
Wireless Features
Setting Menu
Accessories
Appendix
Index





- All images in the camera can be viewed from the connected smartphone when you choose [Yes] in step 8. To keep camera images private, so that they cannot be viewed from the smartphone, choose [No] in step 8.
- Once you have registered a smartphone, you can change privacy settings for it on the camera (📖139).



- Connections require that a memory card be in the camera.
- Once you have connected to devices via the Wi-Fi menu, recent destinations will be listed first when you access the Wi-Fi menu. You can easily connect again by pressing the [▲][▼] buttons to choose the device and then pressing the [📶] button. To add a new device, display the device selection screen by pressing the [◀][▶] buttons, and then configure the setting.
- If you prefer not to display recent target devices, choose MENU (📖29) > [📶] tab > [Wireless settings] > [Wi-Fi Settings] > [Target History] > [Off].
- To connect without entering a password in step 5, choose MENU (📖29) > [📶] tab > [Wireless settings] > [Wi-Fi Settings] > [Password] > [Off]. [Password] is no longer displayed on the SSID screen (in step 4).
- You can also send multiple images at once and change the image size before sending (📖132).
- You can send the current image by choosing [Send this image] on the screen in step 9.

Using Another Access Point

When connecting the camera to a smartphone through the Wi-Fi menu, you can also use an existing access point.

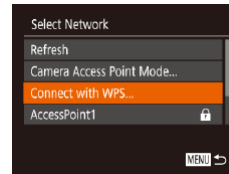
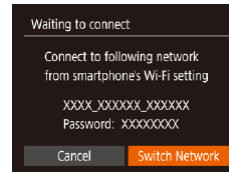

1 Prepare for the connection.

- Access the [Waiting to connect] screen by following steps 1 – 4 in “Adding a Smartphone Using the Wi-Fi Menu” (📖117).

2 Connect the smartphone to the access point.

3 Choose [Switch Network].

- Press the [◀][▶] buttons or turn the [📶] dial to choose [Switch Network], and then press the [📶] button.
- A list of detected access points will be displayed.

4 Connect to an access point.

- For WPS-compatible access points, connect to the access point as described in steps 5 – 8 in “Using WPS-Compatible Access Points” (📖122).
- For non-WPS access points, follow steps 2 – 4 in “Connecting to Listed Access Points” (📖124) to connect to the access point.

Before Use
Basic Guide
Advanced Guide
Camera Basics
Auto Mode / Hybrid Auto Mode
Other Shooting Modes
P Mode
Tv, Av, and M Mode
Playback Mode
Wireless Features
Setting Menu
Accessories
Appendix
Index

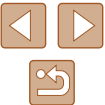



5 Select the camera to connect to.

- On the camera selection screen displayed on the smartphone, choose the camera to begin pairing.

6 Configure the privacy settings and send images.

- Follow steps 8 – 9 in “Adding a Smartphone Using the Wi-Fi Menu” (📖117) to configure the privacy settings and send images.

Previous Access Points

You can reconnect to any previous access points automatically by following step 4 in “Adding a Smartphone Using the Wi-Fi Menu” (📖117).

- To use the camera as an access point, choose [Switch Network] on the screen displayed when you establish a connection, and then choose [Camera Access Point Mode].
- To switch access points, choose [Switch Network] on the screen displayed when you establish a connection, and then follow the procedure in “Using Another Access Point” (📖119) from step 4.

Saving Images to a Computer

Preparing to Register a Computer

For details on computers that you can connect the camera to via Wi-Fi, system requirements, and other compatibility information (including support in new operating systems), visit the Canon website.



- Windows 7 Starter and Home Basic editions are not supported.
- Windows 7 N (European version) and KN (South Korean version) require a separate download and installation of Windows Media Feature Pack.
For details, check the following website.
<http://go.microsoft.com/fwlink/?LinkId=159730>

Installing CameraWindow

1 Download the software.

- Visit the following site from a computer connected to the Internet.

<http://www.canon.com/icpd/>

- Choose your country or region, and then follow the instructions displayed to prepare for downloading.

Before Use

Basic Guide

Advanced Guide

Camera Basics

Auto Mode /
Hybrid Auto Mode

Other Shooting Modes

P Mode

Tv, Av, and M Mode

Playback Mode

Wireless Features

Setting Menu

Accessories

Appendix

Index



2 Follow the instructions displayed.

- Double-click the downloaded file to install it.



- Internet access is required, and any ISP account charges and access fees must be paid separately.



- To uninstall the software, follow these steps.
 - Windows: Select [Start] menu > [All Programs] > [Canon Utilities], and then choose the software for uninstallation.

■ Configuring the Computer for a Wi-Fi Connection (Windows Only)

On a computer running Windows, configure the following settings before connecting the camera to the computer wirelessly.



1 Confirm that the computer is connected to an access point.

- For instructions on checking your network connection, refer to the computer user manual.

2 Configure the setting.

- Click in the following order: [Start] menu > [All Programs] > [Canon Utilities] > [CameraWindow] > [Wi-Fi connection setup].
- In the application that opens, follow the on-screen instructions and configure the setting.



- The following Windows settings are configured when you run the utility in step 2.
 - Turn on media streaming.
This will enable the camera to see (find) the computer to access via Wi-Fi.
 - Turn on network discovery.
This will enable the computer to see (find) the camera.
 - Turn on ICMP (Internet Control Message Protocol).
This allows you to check the network connection status.
 - Enable Universal Plug & Play (UPnP).
This will enable network devices to detect each other automatically.
- Some security software may prevent you from completing the settings as described here. Check the settings of your security software.

Before Use
Basic Guide
Advanced Guide
Camera Basics
Auto Mode / Hybrid Auto Mode
Other Shooting Modes
P Mode
Tv, Av, and M Mode
Playback Mode
Wireless Features
Setting Menu
Accessories
Appendix
Index



Saving Images to a Connected Computer

Connect to your access point via Wi-Fi as follows.
Also refer to the access point user manual.

Confirming Access Point Compatibility

Confirm that the Wi-Fi router or base station conforms to the Wi-Fi standards in “Interface” (183).

Connection methods vary depending on whether the access point supports Wi-Fi Protected Setup (WPS, 122) or not (124). For non-WPS access points, check the following information.

- Network name (SSID/ESSID)
The SSID or ESSID for the access point you use. Also called the “access point name” or “network name”.
- Network authentication / data encryption (encryption method / encryption mode)
The method for encrypting data during wireless transmission. Check which security setting is used: WPA2-PSK (AES), WPA2-PSK (TKIP), WPA-PSK (AES), WPA-PSK (TKIP), WEP (open system authentication), or no security.
- Password (encryption key / network key)
The key used when encrypting data during wireless transmission. Also called the “encryption key” or “network key”.
- Key index (transmit key)
The key set when WEP is used for network authentication / data encryption. Use “1” as the setting.



- If system administrator status is needed to adjust network settings, contact the system administrator for details.
- These settings are very important for network security. Exercise adequate caution when changing these settings.



- For information on WPS compatibility and for instructions on checking settings, refer to the access point user manual.
- A router is a device that creates a network (LAN) structure for connecting multiple computers. A router that contains an internal Wi-Fi function is called a “Wi-Fi router”.
- This guide refers to all Wi-Fi routers and base stations as “access points”.
- If you use MAC address filtering on your Wi-Fi network, be sure to add the camera’s MAC address to your access point. You can check your camera’s MAC address by choosing MENU (29) > [↑] tab > [Wireless settings] > [Wi-Fi Settings] > [Check MAC Address].

Using WPS-Compatible Access Points

WPS makes it easy to complete settings when connecting devices over Wi-Fi. You can use either Push Button Configuration Method or PIN Method for settings on a WPS supported device.

1 Confirm that the computer is connected to an access point.

- For instructions on checking the connection, refer to the device and access point user manuals.

2 Access the Wi-Fi menu.

- Press the [WPS] button.
- If the [Device Nickname] screen is displayed, press the [▲][▼] buttons or turn the [DIAL] dial to choose [OK], and then press the [MENU] button.

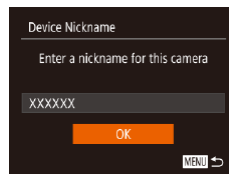

Before Use

Basic Guide

Advanced Guide

Camera Basics

Auto Mode / Hybrid Auto Mode

Other Shooting Modes

P Mode

Tv, Av, and M Mode

Playback Mode

Wireless Features

Setting Menu

Accessories

Appendix

Index



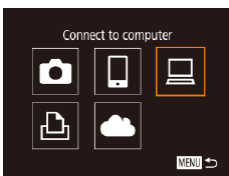

3 Choose [Laptop].

- Press the [▲][▼][◀][▶] buttons or turn the [Dial] dial to choose [Laptop], and then press the [WPS] button.



4 Choose [Add a Device].

- Press the [▲][▼] buttons or turn the [Dial] dial to choose [Add a Device], and then press the [WPS] button.

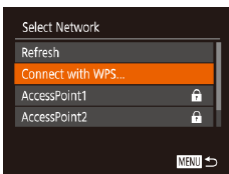

5 Choose [Connect with WPS].

- Press the [▲][▼] buttons or turn the [Dial] dial to choose [Connect with WPS], and then press the [WPS] button.

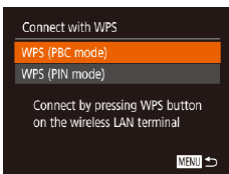

6 Choose [WPS (PBC mode)].

- Press the [▲][▼] buttons or turn the [Dial] dial to choose [WPS (PBC mode)], and then press the [WPS] button.



7 Establish the connection.

- On the access point, hold down the WPS connection button for a few seconds.



- On the camera, press the [WPS] button to go to the next step.
- The camera connects to the access point and lists devices connected to it on the [Select a Device] screen.

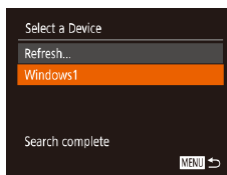

8 Choose the target device.

- Choose the target device name (either press the [▲][▼] buttons or turn the [Dial] dial), and then press the [WPS] button.

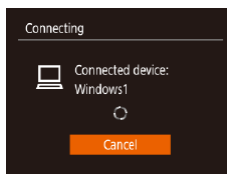

9 Install a driver (first Windows connection only).

- When this screen is displayed on the camera, click the Start menu on the computer, click [Control Panel], and then click [Add a device].

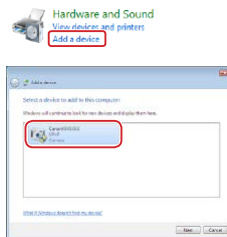

- Double-click the connected camera icon.
- Driver installation will begin.
- After driver installation is complete, and the camera and computer connection is enabled, the AutoPlay screen will be displayed. Nothing will be displayed on the camera screen.

Before Use
Basic Guide
Advanced Guide
Camera Basics
Auto Mode / Hybrid Auto Mode
Other Shooting Modes
P Mode
Tv, Av, and M Mode
Playback Mode
Wireless Features
Setting Menu
Accessories
Appendix
Index



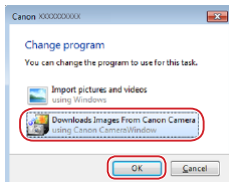

10 Display CameraWindow.

- Windows: Access CameraWindow by clicking [Downloads Images From Canon Camera].

11 Import images.

- Click [Import Images from Camera], and then click [Import Untransferred Images].
- Images are now saved to the Pictures folder on the computer, in separate folders named by date.
- Click [OK] in the screen that is displayed after image import is complete.
- To view images you save to a computer, use preinstalled or commonly available software compatible with images captured by the camera.



- Once you have connected to devices via the Wi-Fi menu, recent destinations will be listed first when you access the Wi-Fi menu. You can easily connect again by pressing the [▲][▼] buttons to choose the device and then pressing the [Wi-Fi] button. To add a new device, display the device selection screen by pressing the [◀][▶] buttons, and then configure the setting.
- If you prefer not to display recent target devices, choose MENU (📖29) > [↑] tab > [Wireless settings] > [Wi-Fi Settings] > [Target History] > [Off].
- You can also change the camera nickname on the screen in step 2 (📖141).
- When the camera is connected to a computer, the camera screen is blank.
- To disconnect from the camera, turn off the camera.
- If you chose [WPS (PIN mode)] in step 6, a PIN code will be displayed on the screen. Be sure to set this code in the access point. Choose a device in the [Select a Device] screen. For further details, refer to the user manual included with your access point.

Connecting to Listed Access Points

1 View the listed access points.

- View the listed networks (access points) as described in steps 1 – 4 of “Using WPS-Compatible Access Points” (📖122).

2 Choose an access point.

- Press the [▲][▼] buttons or turn the [🌀] dial to choose a network (access point), and then press the [Wi-Fi] button.

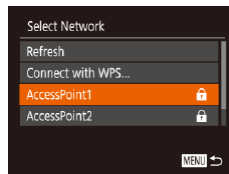

Before Use
Basic Guide
Advanced Guide
Camera Basics
Auto Mode / Hybrid Auto Mode
Other Shooting Modes
P Mode
Tv, Av, and M Mode
Playback Mode
Wireless Features
Setting Menu
Accessories
Appendix
Index





3 Enter the access point password.

- Press the [OK] button to access the keyboard, and then enter the password (130).
- Press the [▲][▼] buttons or turn the [DISP] dial to choose [Next], and then press the [OK] button.

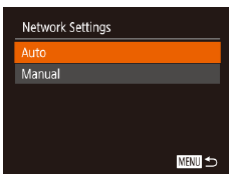

4 Choose [Auto].

- Press the [▲][▼] buttons or turn the [DISP] dial to choose [Auto], and then press the [OK] button.
- To save images to a connected computer, follow the procedure from step 8 in “Using WPS-Compatible Access Points” (122).



- To determine the access point password, check on the access point itself or refer to the user manual.
- If no access points are detected even after you choose [Refresh] in step 2 to update the list, choose [Manual Settings] in step 2 to complete access point settings manually. Follow on-screen instructions and enter an SSID, security settings, and a password.
- When you use an access point that you have already connected to for connecting to another device, [*] is displayed for the password in step 3. To use the same password, choose [Next] (either press the [▲][▼] buttons or turn the [DISP] dial) and press the [OK] button.

Previous Access Points

You can reconnect to any previous access points automatically by following step 4 in “Using WPS-Compatible Access Points” (122).

- To connect to a device via an access point, confirm that the target device is already connected to the access point, and then follow the procedure from step 8 in “Using WPS-Compatible Access Points” (122).
- To switch access points, choose [Switch Network] on the screen displayed when you establish a connection, and then either follow the procedure in “Using WPS-Compatible Access Points” (122) from step 5 or the procedure in “Connecting to Listed Access Points” (124) from step 2.

Before Use
Basic Guide
Advanced Guide
Camera Basics
Auto Mode / Hybrid Auto Mode
Other Shooting Modes
P Mode
Tv, Av, and M Mode
Playback Mode
Wireless Features
Setting Menu
Accessories
Appendix
Index

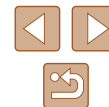

Sending Images to a Registered Web Service

Registering Web Services

Use a smartphone or computer to add to the camera Web services that you want to use.

- A smartphone or computer with a browser and Internet connection is required to complete camera settings for CANON iMAGE GATEWAY and other Web services.
- Check the CANON iMAGE GATEWAY website for details on browser (Microsoft Internet Explorer, etc.) requirements, including settings and version information.
- For information on countries and regions where CANON iMAGE GATEWAY is available, visit the Canon website (<http://www.canon.com/cig/>).
- You must have an account with Web services other than CANON iMAGE GATEWAY if you desire to use them. For further details, check the websites for each Web service you want to register.
- Separate ISP connection and access point fees may be applicable.



- CANON iMAGE GATEWAY also provides user guides for downloading.

Registering CANON iMAGE GATEWAY

Link the camera and CANON iMAGE GATEWAY by adding CANON iMAGE GATEWAY as a destination Web service on the camera. Note that you will need to enter an email address used on your computer or smartphone to receive a notification message for completing linkage settings.



1 Access the Wi-Fi menu.

- Press the **[Wi-Fi]** button.
- If the [Device Nickname] screen is displayed, press the **[▲][▼]** buttons or turn the **[DISP.]** dial to choose [OK], and then press the **[Wi-Fi]** button.

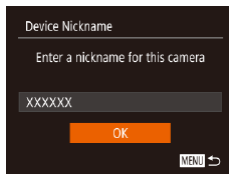

2 Choose [Cloud].

- Press the **[▲][▼][◀][▶]** buttons or turn the **[DISP.]** dial to choose **[Cloud]**, and then press the **[Wi-Fi]** button.

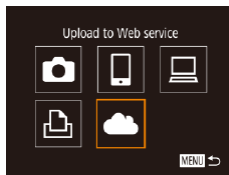

3 Accept the agreement to enter an email address.

- Read the agreement displayed, press the **[◀][▶]** buttons or turn the **[DISP.]** dial to choose [I Agree], and then press the **[Wi-Fi]** button.

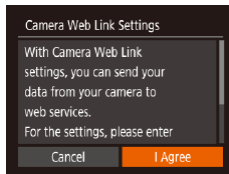

Before Use
Basic Guide
Advanced Guide
Camera Basics
Auto Mode / Hybrid Auto Mode
Other Shooting Modes
P Mode
Tv, Av, and M Mode
Playback Mode
Wireless Features
Setting Menu
Accessories
Appendix
Index



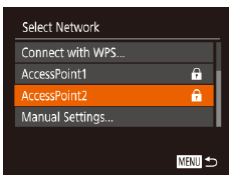

4 Establish a connection with an access point.

- Connect to the access point as described in steps 5 – 7 in “Using WPS-Compatible Access Points” (📖122) or in steps 2 – 4 in “Connecting to Listed Access Points” (📖124).

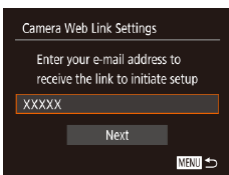

5 Enter your email address.

- Once the camera is connected to CANON iMAGE GATEWAY via the access point, a screen is displayed for entering an email address.
- Enter your email address, press the [▲][▼] buttons or turn the [🌀] dial to choose [Next], and then press the [📧] button.

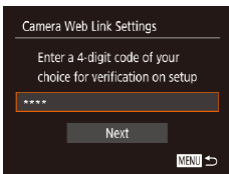

6 Enter a four-digit number.

- Enter a four-digit number of your choice, press the [▲][▼] buttons or turn the [🌀] dial to choose [Next], and then press the [📧] button.
- You will need this four-digit number later when setting up linkage with CANON iMAGE GATEWAY in step 8.

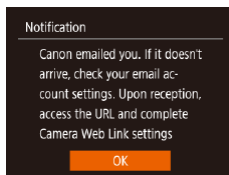

7 Check for the notification message.

- Once information has been sent to CANON iMAGE GATEWAY, you will receive a notification message at the email address entered in step 5.
- Press the [📧] button on the next screen, which indicates that notification has been sent.
- [☁️] now changes to [📧].

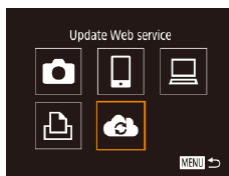

8 Access the page in the notification message and complete camera link settings.

- From a computer or smartphone, access the page linked in the notification message.
- Follow the instructions to complete the settings on the camera link settings page.

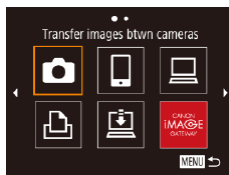

9 Complete CANON iMAGE GATEWAY settings on the camera.

- Press the [▲][▼][◀][▶] buttons or turn the [🌀] dial to choose [📧], and then press the [📧] button.
- [📧] (📖134) and CANON iMAGE GATEWAY are now added as destinations.
- You can add other Web services, as needed. In this case, follow the instructions from step 2 in “Registering Other Web Services” (📖128).

Before Use
Basic Guide
Advanced Guide
Camera Basics
Auto Mode / Hybrid Auto Mode
Other Shooting Modes
P Mode
Tv, Av, and M Mode
Playback Mode
Wireless Features
Setting Menu
Accessories
Appendix
Index

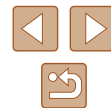



- Make sure initially that your computer or smartphone mail application is not configured to block email from relevant domains, which may prevent you from receiving the notification message.



- You can also change the camera nickname on the screen in step 1 (126).
- Once you have connected to devices via the Wi-Fi menu, recent destinations will be listed first when you access the menu. Press the [◀][▶] buttons to access the device selection screen and then configure the setting.

Registering Other Web Services

You can also add Web services besides CANON IMAGE GATEWAY to the camera.



1 Log in to CANON iMAGE GATEWAY and access the camera link settings page.

- From a computer or smartphone, access <http://www.canon.com/cig/> to visit CANON iMAGE GATEWAY.



2 Configure the Web service you want to use.

- On the computer or smartphone, display the Web service settings screen.
- Follow the on-screen instructions to complete settings for Web services you want to use.

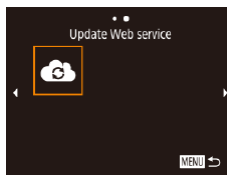

3 Choose [G].

- Press the [(Q)] button.
- Press the [▲][▼][◀][▶] buttons or turn the [DIAL] dial to choose [G], and then press the [OK] button.
- The Web service settings are now updated.



- If any configured settings change, follow these steps again to update the camera settings.

Uploading Images to Web Services



1 Access the Wi-Fi menu.

- Press the [(Q)] button.



2 Choose the destination.

- Choose the icon of the Web service to connect to (either press the [▲][▼][◀][▶] buttons or turn the [DIAL] dial), and then press the [OK] button.
- If multiple recipients or sharing options are used with a Web service, choose the desired item on the [Select Recipient] screen (either press the [▲][▼] buttons or turn the [DIAL] dial), and then press the [OK] button.

Before Use
Basic Guide
Advanced Guide
Camera Basics
Auto Mode / Hybrid Auto Mode
Other Shooting Modes
P Mode
Tv, Av, and M Mode
Playback Mode
Wireless Features
Setting Menu
Accessories
Appendix
Index

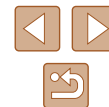

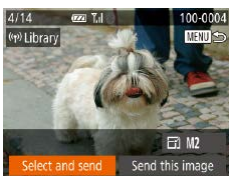

3 Send an image.

- Press the [▲][▼][◀][▶] buttons to choose [Select and send], and then press the [ⓘ] button.
- Press the [▲][▼] buttons or turn the [DISP] dial to choose [Select], and then press the [ⓘ] button.
- Press the [▲][▼][◀][▶] buttons or turn the [DISP] dial to choose an image to send, press the [ⓘ] button to mark it as selected ([✓]), and then press the [MENU] button.
- Press the [◀][▶] buttons or turn the [DISP] dial to choose [OK], and then press the [ⓘ] button.
- Press the [◀][▶] buttons or turn the [DISP] dial to choose [Send], and then press the [ⓘ] button.
- When uploading to YouTube, read the terms of service, choose [I Agree], and press the [ⓘ] button.
- Press the [ⓘ] button to return to the playback screen once [OK] is displayed after the image is sent.



- Connections require that a memory card with saved images be in the camera.
- You can also send multiple images at once, resize images, and add comments before sending (📖132).
- You can send the current image by choosing [Send this image] on the screen in step 3.
- To view images uploaded to CANON iMAGE GATEWAY on a smartphone, try the dedicated Canon Online Photo Album app. Download and install the Canon Online Photo Album app for iPhones or iPads from the App Store or for Android devices from Google Play.

Printing Images Wirelessly from a Connected Printer

Connect the camera to a printer via Wi-Fi to print as follows. These steps show how to use the camera as an access point, but you can also use an existing access point (📖119).

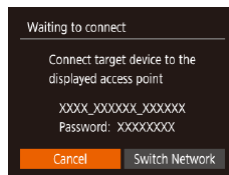
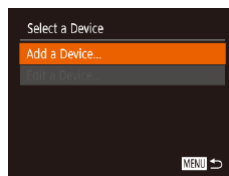

1 Access the Wi-Fi menu.

- Press the [☰] button.

2 Choose [☰].

- Press the [▲][▼][◀][▶] buttons or turn the [DISP] dial to choose [☰], and then press the [ⓘ] button.

3 Choose [Add a Device].

- Press the [▲][▼] buttons or turn the [DISP] dial to choose [Add a Device], and then press the [ⓘ] button.
- The camera SSID and password are displayed.

Before Use
Basic Guide
Advanced Guide
Camera Basics
Auto Mode / Hybrid Auto Mode
Other Shooting Modes
P Mode
Tv, Av, and M Mode
Playback Mode
Wireless Features
Setting Menu
Accessories
Appendix
Index

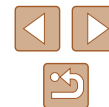



4 Connect the printer to the network.

- In the printer's Wi-Fi setting menu, choose the SSID (network name) displayed on the camera to establish a connection.
- In the password field, enter the password displayed on the camera.

5 Choose the printer.

- Choose the printer name (either press the [▲][▼] buttons or turn the [DISP] dial, and then press the [OK] button.

6 Choose an image to print.

- Press the [◀][▶] buttons or turn the [DISP] dial to choose an image.
- Press the [OK] button, choose [Print], and press the [OK] button again.
- Press the [▲][▼] buttons or turn the [DISP] dial to choose [Print], and then press the [OK] button.
- For detailed printing instructions, see "Printing Images" (157).
- To end the connection, press the [EXIT] button, choose [OK] on the confirmation screen (either press the [◀][▶] buttons or turn the [DISP] dial), and then press the [OK] button.

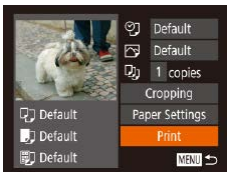
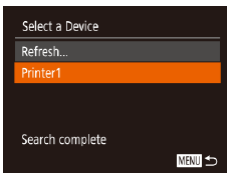

- Connections require that a memory card with saved images be in the camera.
- Once you have connected to devices via the Wi-Fi menu, recent destinations will be listed first when you access the Wi-Fi menu. You can easily connect again by pressing the [▲][▼] buttons to choose the device and then pressing the [OK] button. To add a new device, display the device selection screen by pressing the [◀][▶] buttons, and then configure the setting.
- If you prefer not to display recent target devices, choose MENU (129) > [↑] tab > [Wireless settings] > [Wi-Fi Settings] > [Target History] > [Off].
- To connect without entering a password in step 4, choose MENU (129) > [↑] tab > [Wireless settings] > [Wi-Fi Settings] > [Password] > [Off]. [Password] is no longer displayed on the SSID screen (in step 3).
- To use another access point, follow steps 3 – 4 in "Using Another Access Point" (119).

Before Use
Basic Guide
Advanced Guide
Camera Basics
Auto Mode / Hybrid Auto Mode
Other Shooting Modes
P Mode
Tv, Av, and M Mode
Playback Mode
Wireless Features
Setting Menu
Accessories
Appendix
Index



Sending Images to Another Camera

Connect two cameras via Wi-Fi and send images between them as follows.

- Only Wi-Fi compatible Canon cameras can be connected via Wi-Fi. You cannot connect to a Canon camera unless it is Wi-Fi compatible, even if it supports FlashAir/Eye-Fi cards.



1 Access the Wi-Fi menu.

- Press the **[Wi-Fi]** button.

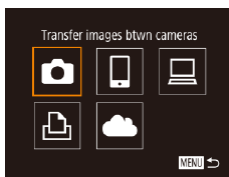

2 Choose [Camera].

- Press the **[▲][▼][◀][▶]** buttons or turn the **[Q]** dial to choose **[Camera]**, and then press the **[MENU]** button.

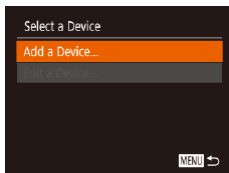

3 Choose [Add a Device].

- Press the **[▲][▼]** buttons or turn the **[Q]** dial to choose **[Add a Device]**, and then press the **[MENU]** button.
- Follow steps 1 – 3 on the target camera too.
- Camera connection information will be added when **[Start connection on target camera]** is displayed on both camera screens.

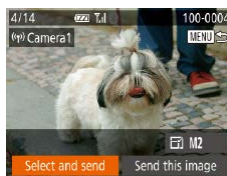

4 Send an image.

- Press the **[▲][▼][◀][▶]** buttons to choose **[Select and send]**, and then press the **[MENU]** button.
- Press the **[▲][▼]** buttons or turn the **[Q]** dial to choose **[Select]**, and then press the **[MENU]** button.
- Press the **[▲][▼][◀][▶]** buttons or turn the **[Q]** dial to choose an image to send, press the **[MENU]** button to mark it as selected (**[✓]**), and then press the **[MENU]** button.
- Press the **[◀][▶]** buttons or turn the **[Q]** dial to choose **[OK]**, and then press the **[MENU]** button.
- Press the **[◀][▶]** buttons or turn the **[Q]** dial to choose **[Send]**, and then press the **[MENU]** button.
- **[Transfer completed]** is displayed after the image is sent, and the image transfer screen is displayed again.
- To end the connection, press the **[MENU]** button, choose **[OK]** on the confirmation screen (either press the **[◀][▶]** buttons or turn the **[Q]** dial), and then press the **[MENU]** button.

Before Use

Basic Guide

Advanced Guide

Camera Basics

Auto Mode /
Hybrid Auto Mode

Other Shooting Modes

P Mode

Tv, Av, and M Mode

Playback Mode

Wireless Features

Setting Menu

Accessories

Appendix

Index

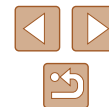



- Connections require that a memory card be in the camera.
- Once you have connected to devices via the Wi-Fi menu, recent destinations will be listed first when you access the Wi-Fi menu. You can easily connect again by pressing the [▲][▼] buttons to choose the device and then pressing the [MENU] button. To add a new device, display the device selection screen by pressing the [◀][▶] buttons, and then configure the setting.
- If you prefer not to display recent target devices, choose MENU (29) > [Wi-Fi] tab > [Wireless settings] > [Wi-Fi Settings] > [Target History] > [Off].
- You can also send multiple images at once and change the image size before sending (132).
- You can send the current image by choosing [Send this image] on the screen in step 4.

Image Sending Options

You can choose multiple images to send at once and change the image recording pixel setting (size) before sending. Some Web services also enable you to annotate the images you send.

Sending Multiple Images

On the image transfer screen, specify a range of images to send, or send only images tagged as favorites.

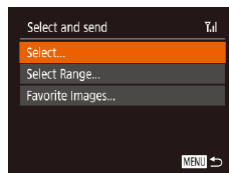

1 Choose [Select and send].

- On the image transfer screen, press the [◀][▶] buttons to choose [Select and send], and then press the [MENU] button.

2 Choose a selection method.

- Press the [▲][▼] buttons or turn the [DISP] dial to choose a selection method.

Before Use

Basic Guide

Advanced Guide

Camera Basics

Auto Mode /
Hybrid Auto Mode

Other Shooting Modes

P Mode

Tv, Av, and M Mode

Playback Mode

Wireless Features

Setting Menu

Accessories

Appendix

Index

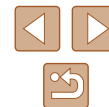

Selecting a Range

1 Choose [Select Range].

- Following step 2 in “Sending Multiple Images” (📖132), choose [Select Range] and press the [OK] button.

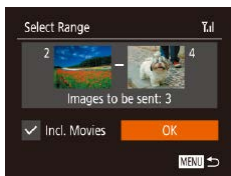

2 Choose images.

- Follow steps 2 – 3 in “Selecting a Range” (📖97) to specify images.
- To include movies, press the [▲][▼][◀][▶] buttons to choose [Incl. Movies], and then press the [OK] button to mark the option as selected (✓).
- Press the [▲][▼][◀][▶] buttons to choose [OK], and then press the [OK] button.

3 Send the images.

- Press the [◀][▶] buttons or turn the [DISP.] dial to choose [Send], and then press the [OK] button.

Sending Favorite Images

Send only images tagged as favorites (📖101).

1 Choose [Favorite Images].

- Following step 2 in “Sending Multiple Images” (📖132), choose [Favorite Images] and press the [OK] button.
- An image selection screen for favorites is displayed. If you prefer not to include an image, choose the image and press the [DISP.] button to remove [✓].
- Press the [MENU] button.

- Press the [◀][▶] buttons or turn the [DISP.] dial to choose [OK], and then press the [OK] button.

2 Send the images.

- Press the [◀][▶] buttons or turn the [DISP.] dial to choose [Send], and then press the [OK] button.



- In step 1, [Favorite Images] is not available unless you have tagged images as favorites.

Notes on Sending Images

- Depending on the condition of the network you are using, it may take a long time to send movies. Be sure to keep an eye on the camera battery level.
- Web services may limit the number of images or length of movies you can send.
- For movies that you do not compress (📖106), a separate, compressed file is sent instead of the original file. Note that this may delay transmission, and the file cannot be sent unless there is enough space for it on the memory card.
- When sending movies to smartphones, note that the supported image quality varies depending on the smartphone. For details, refer to the smartphone user manual.
- On the screen, wireless signal strength is indicated by the following icons:
[📶] high, [📶] medium, [📶] low, [📶] weak
- Sending images to Web services will take less time when resending images you have already sent that are still on the CANON iIMAGE GATEWAY server.

Before Use

Basic Guide

Advanced Guide

Camera Basics

Auto Mode /
Hybrid Auto Mode

Other Shooting Modes

P Mode

Tv, Av, and M Mode

Playback Mode

Wireless Features

Setting Menu

Accessories

Appendix

Index



Choosing the Number of Recording Pixels (Image Size)

On the image transfer screen, choose [F] by pressing the [▲][▼] buttons, and then press the [⊕] button. On the screen displayed, choose the recording pixel setting (image size) by pressing the [▲][▼] buttons, and then press the [⊕] button.

- To send images at original size, select [No] as the resizing option.
- Choosing [M2] will resize images that are larger than the selected size before sending.
- Movies cannot be resized.



- Image size can also be configured in MENU (129) > [↑] tab > [Wireless settings] > [Wi-Fi Settings] > [Resize for Sending].

Adding Comments

Using the camera, you can add comments to images that you send to e-mail addresses, social networking services, etc. The number of characters and symbols that can be entered may differ depending on the Web service.

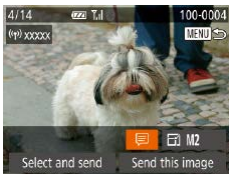

1 Access the screen for adding comments.

- On the image transfer screen, choose [F] by pressing the [▲][▼][▶] buttons, and then press the [⊕] button.

2 Add a comment (130).

3 Send the image.



- When a comment is not entered, the comment set in CANON iIMAGE GATEWAY is automatically sent.
- You can also annotate multiple images before sending them. The same comment is added to all images sent together.

Sending Images Automatically (Image Sync)

Images on the memory card that have not been transferred already can be sent to a computer or Web services via CANON iIMAGE GATEWAY. Note that images cannot be sent only to Web services.

Initial Preparations

■ Preparing the Camera

Register [F] as the destination. On the destination computer, you will install and configure Image Transfer Utility, free software compatible with Image Sync.



1 Add [F] as a destination.

- Add [F] as a destination, as described in “Registering CANON iIMAGE GATEWAY” (126).
- To include a Web service as the destination, log in to CANON iIMAGE GATEWAY (126), select your camera model, access the Web service settings screen, and choose the destination Web service in Image Sync settings. For details, refer to CANON iIMAGE GATEWAY Help.

Before Use
Basic Guide
Advanced Guide
Camera Basics
Auto Mode / Hybrid Auto Mode
Other Shooting Modes
P Mode
Tv, Av, and M Mode
Playback Mode
Wireless Features
Setting Menu
Accessories
Appendix
Index

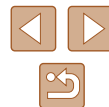

2 Choose the type of images to send (only when sending movies with images).

- Press the [MENU] button, choose [Wireless settings] on the [Wi-Fi] tab, and then choose [Wi-Fi Settings] (129).
- Press the [▲][▼] buttons to choose [Image Sync], and then press the [◀][▶] buttons to choose [Stills/Movies].

■ Preparing the Computer

Install and configure the software on the destination computer.



1 Install Image Transfer Utility.

- Install Image Transfer Utility on a computer connected to the Internet (155) by following steps 1 – 2 of “Installing CameraWindow” (120).
- Image Transfer Utility can also be downloaded from the Image Sync settings page of CANON iMAGE GATEWAY (126).

2 Register the camera.

- Windows: In the taskbar, right-click [i], and then click [Add new camera].
- Mac OS: In the menu bar, click [i], and then click [Add new camera].
- A list of cameras linked to CANON iMAGE GATEWAY is displayed. Choose the camera from which images are to be sent.
- Once the camera is registered and the computer is ready to receive images, the icon changes to [i].

Sending Images

Images sent from the camera are automatically saved to the computer. If the computer that you intend to send images to is turned off, the images will be stored temporarily on the CANON iMAGE GATEWAY server. Stored images are regularly erased, so make sure to turn on the computer and save the images.

1 Send images.

- Follow steps 1 – 2 in “Uploading Images to Web Services” (128) and choose [i].
- Sent images are labeled with a [i] icon.

2 Save the images to the computer.

- Images are automatically saved to the computer when you turn it on.
- Images are automatically sent to Web services from the CANON iMAGE GATEWAY server, even if the computer is off.



- When sending images, you should use a fully charged battery pack.



- Even if images were imported to the computer through a different method, any images not sent to the computer via CANON iMAGE GATEWAY will be sent to the computer.
- Sending is faster when the destination is a computer on the same network as the camera, because images are sent via the access point instead of CANON iMAGE GATEWAY. Note that images stored on the computer are sent to CANON iMAGE GATEWAY, so the computer must be connected to the Internet.

Before Use
Basic Guide
Advanced Guide
Camera Basics
Auto Mode / Hybrid Auto Mode
Other Shooting Modes
P Mode
Tv, Av, and M Mode
Playback Mode
Wireless Features
Setting Menu
Accessories
Appendix
Index



Viewing Images Sent via Image Sync on a Smartphone

By installing the Canon Online Photo Album (Canon OPA) app, you can use your smartphone to view and download images sent via Image Sync while they are stored temporarily on the CANON iMAGE GATEWAY server.

In preparation, enable smartphone access as follows.

- Make sure you have completed the settings described in “Preparing the Computer” (📖135).
- Download and install the Canon Online Photo Album app for iPhones or iPads from the App Store or for Android devices from Google Play.
- Log in to CANON iMAGE GATEWAY (📖126), select your camera model, access the Web service settings screen, and enable viewing and downloading from a smartphone in the Image Sync settings. For details, refer to CANON iMAGE GATEWAY Help.



- Once images stored temporarily on the CANON iMAGE GATEWAY server have been deleted, they can no longer be viewed.
- Images you sent before enabling smartphone viewing and downloading in Image Sync settings cannot be accessed this way.



- For Canon Online Photo Album instructions, refer to Canon Online Photo Album Help.

Using a Smartphone to View Camera Images and Control the Camera

You can do the following with the dedicated smartphone app Camera Connect.

- Browse images on the camera and save them to the smartphone
- Geotag images as you shoot (📖136)
- Control the camera remotely from a smartphone (📖138)



- Privacy settings must be configured in advance to allow image viewing on the smartphone (📖117, 📖139).

Geotagging Images When You Shoot

Still images and movies you shoot can be geotagged using GPS information (such as latitude, longitude, and elevation) from a Bluetooth enabled smartphone. You can review the recorded GPS information on the camera (📖89). Using the software (📖155), you can also view the locations on a map, with the still images and movies shown next to them.

1 Connect the camera and smartphone via Bluetooth (📖113).

2 Choose [GPS settings].

- Press the [MENU] button, choose [GPS settings] on the [📷] tab, and then press the [📶] button.



Before Use

Basic Guide

Advanced Guide

Camera Basics

Auto Mode / Hybrid Auto Mode

Other Shooting Modes

P Mode

Tv, Av, and M Mode

Playback Mode

Wireless Features

Setting Menu

Accessories

Appendix

Index



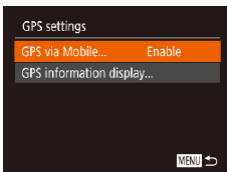

3 Configure the setting.

- Choose [GPS via Mobile], and then press the [◀][▶] buttons or turn the [DISP] dial to choose [Enable].

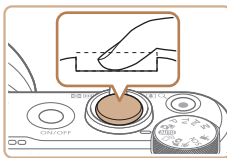

4 Shoot.

- The still images and movies you shoot are now geotagged using smartphone GPS information, which you can check as described in “GPS Information Display” (89).
- Next time, after starting Camera Connect on your smartphone, make sure the camera and smartphone are connected via Bluetooth before shooting.



- Images are not geotagged this way unless Camera Connect is running.
- The GPS information added to your movie is acquired initially, when you start shooting.
- GPS information cannot be updated unless Wi-Fi is off.
- The GPS information added to images in remote live view shooting is acquired initially, when you switch to a Wi-Fi connection.
- Images may not be geotagged if you connect via NFC or Bluetooth when the camera is off.
- Others may be able to locate or identify you by using location data in your geotagged still images or movies. Be careful when sharing these images with others, as when posting images online where many others can view them.



- To check the GPS information acquired from the smartphone, choose MENU (29) > [↑] tab > [GPS settings] > [GPS information display].
- GPS acquisition status is indicated by one of the following icons. [GPS] Acquiring, [GPS] Not acquiring

Before Use
Basic Guide
Advanced Guide
Camera Basics
Auto Mode / Hybrid Auto Mode
Other Shooting Modes
P Mode
Tv, Av, and M Mode
Playback Mode
Wireless Features
Setting Menu
Accessories
Appendix
Index

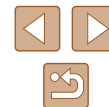

Controlling the Camera Remotely from a Smartphone

Controlling the Camera via Wi-Fi

You can shoot as you view a shooting screen on your smartphone.



- Privacy settings must be configured in advance to allow viewing of all images from the smartphone (📖117).

1 Secure the camera.

- Keep the camera still by mounting it on a tripod or taking other measures.

2 Connect the camera and smartphone (📖117).

- In the privacy settings, choose [Yes].

3 Choose remote live view shooting.

- In Camera Connect on the smartphone, choose [Remote live view shooting].
- Once the camera is ready for remote live view shooting, a live image from the camera is displayed on the smartphone.
- At this time, a message is displayed on the camera, and all operations except pressing the power button are disabled.

4 Shoot.

- Use the smartphone to shoot.



- Movie shooting is not available.
- Focusing may take longer.
- Image display or shutter release may be delayed, depending on the connection status.



- Any rough subject motion shown on the smartphone due to the connection environment will not affect recorded images.
- Captured images are not transferred to the smartphone. Use the smartphone to browse and transfer images from the camera.

Controlling the Camera via Bluetooth

You can use a Bluetooth enabled smartphone for remote shooting and switching of image display.

This is convenient if you want to connect quickly while shooting, or if you will control playback while connected to a TV.

1 Prepare the camera.

- Set the shooting mode and the shooting functions on the camera.
- Keep the camera still by mounting it on a tripod or taking other measures when shooting.

2 Connect the camera and smartphone (📖113).

- Make sure that the Bluetooth connection has been established.

3 Choose Bluetooth remote controller.

- In Camera Connect on the smartphone, choose [Bluetooth remote controller].
- The smartphone screen changes to a screen for remote control via Bluetooth.

Before Use

Basic Guide

Advanced Guide

Camera Basics

Auto Mode /
Hybrid Auto Mode

Other Shooting Modes

P Mode

Tv, Av, and M Mode

Playback Mode

Wireless Features

Setting Menu

Accessories

Appendix

Index

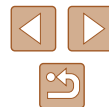

4 Shoot and switch images.

- Use the smartphone to shoot in Shooting mode and switch images in Playback mode.



- [Bluetooth remote controller] is not available when connected via Wi-Fi.



- You can check the Bluetooth connection status by referring to the icon on the screen (113).

Editing or Erasing Wi-Fi Settings

Edit or erase Wi-Fi settings as follows.

Editing Connection Information

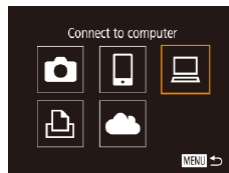

1 Access the Wi-Fi menu and choose a device to edit.

- Press the $[\text{Q}]/[\text{P}]$ button.
- Press the $[\text{▲}][\text{▼}][\text{◀}][\text{▶}]$ buttons or turn the $[\text{DISP}]$ dial to choose the icon of a device to edit, and then press the $[\text{MENU}]$ button.

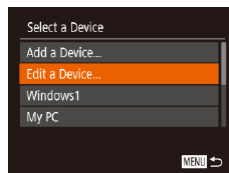

2 Choose [Edit a Device].

- Press the $[\text{▲}][\text{▼}]$ buttons or turn the $[\text{DISP}]$ dial to choose [Edit a Device], and then press the $[\text{MENU}]$ button.

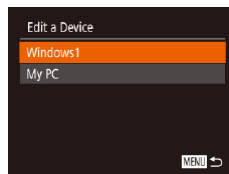

3 Choose the device to edit.

- Press the $[\text{▲}][\text{▼}]$ buttons or turn the $[\text{DISP}]$ dial to choose the device to edit, and then press the $[\text{MENU}]$ button.

4 Choose the item to edit.

- Press the $[\text{▲}][\text{▼}]$ buttons or turn the $[\text{DISP}]$ dial to choose the item to edit, and then press the $[\text{MENU}]$ button.
- The items you can change depend on the device or service.

Before Use

Basic Guide

Advanced Guide

Camera Basics

Auto Mode /
Hybrid Auto Mode

Other Shooting Modes

P Mode

Tv, Av, and M Mode

Playback Mode

Wireless Features

Setting Menu

Accessories

Appendix

Index



Configurable Items	Connection				
					Web Services
[Change Device Nickname] (📖140)	<input type="radio"/>	<input type="radio"/>	<input type="radio"/>	<input type="radio"/>	–
[View Settings] (📖117)	–	<input type="radio"/>	–	–	–
[Erase Connection Info] (📖140)	<input type="radio"/>	<input type="radio"/>	<input type="radio"/>	<input type="radio"/>	–

O : Configurable – : Not configurable

Changing a Device Nickname

You can change the device nickname (display name) that is displayed on the camera.

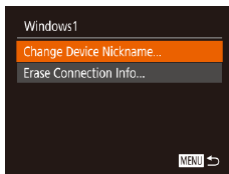

- Following step 4 in “Editing Connection Information” (📖139), choose [Change Device Nickname] and press the [OK] button.
- Select the input field and press the [OK] button. Use the keyboard displayed to enter a new nickname (📖30).

Erasing Connection Information

Erase connection information (information about devices that you have connected to) as follows.

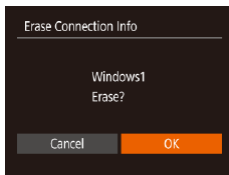

- Following step 4 in “Editing Connection Information” (📖139), choose [Erase Connection Info] and press the [OK] button.
- After [Erase?] is displayed, press the [Left] [Right] buttons or turn the [Dial] to choose [OK], and then press the [OK] button.
- The connection information will be erased.

Specifying Images Viewable from Smartphones

Specify whether all images on the camera's memory card can be viewed from smartphones connected to the camera.

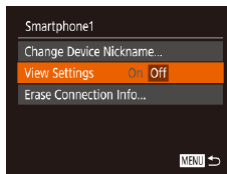

- Choose [View Settings] in step 4 of “Editing Connection Information” (📖139) and choose the desired option.



- For remote live view shooting, choose [On].

Before Use
Basic Guide
Advanced Guide
Camera Basics
Auto Mode / Hybrid Auto Mode
Other Shooting Modes
P Mode
Tv, Av, and M Mode
Playback Mode
Wireless Features
Setting Menu
Accessories
Appendix
Index

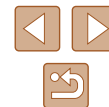

Changing the Camera Nickname

Change the camera nickname (displayed on connected devices) as desired.



1 Choose [Wireless settings].

- Press the [MENU] button and choose [Wireless settings] on the [Wi-Fi] tab (📖29).

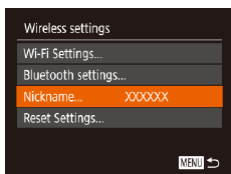

2 Choose [Nickname].

- Press the [▲][▼] buttons or turn the [DISP] dial to choose [Nickname], and then press the [OK] button (📖29).

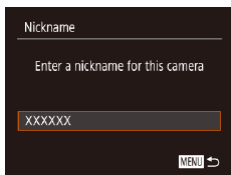

3 Change the nickname.

- Press the [OK] button to access the keyboard (📖30), and then enter a nickname.



- A message is displayed if the nickname you enter begins with a symbol or space. Press the [OK] button and enter a different nickname.
- You can also change the nickname from the [Device Nickname] screen displayed when you first use Wi-Fi. In this case, select the text box, press the [OK] button to access the keyboard, and then enter a new nickname.

Returning the Wi-Fi Settings to Default

Return the Wi-Fi settings to default if you transfer ownership of the camera to another person, or dispose of it. Resetting the Wi-Fi settings will also clear all Web service settings. Be sure that you want to reset all Wi-Fi settings before using this option.



1 Choose [Wireless settings].

- Press the [MENU] button and choose [Wireless settings] on the [Wi-Fi] tab (📖29).

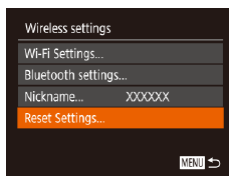

2 Choose [Reset Settings].

- Press the [▲][▼] buttons or turn the [DISP] dial to choose [Reset Settings], and then press the [OK] button.

3 Restore the default settings.

- Press the [◀][▶] buttons or turn the [DISP] dial to choose [OK], and then press the [OK] button.
- The Wi-Fi settings are now reset.



- To reset other settings (aside from Wi-Fi) to defaults, choose [Reset camera] on the [Wi-Fi] tab (📖149).

Before Use

Basic Guide

Advanced Guide

Camera Basics

Auto Mode /
Hybrid Auto Mode

Other Shooting Modes

P Mode

Tv, Av, and M Mode

Playback Mode

Wireless Features

Setting Menu

Accessories

Appendix

Index



Clearing Information of Devices Paired via Bluetooth

Before pairing with a different smartphone, clear the information about any connected smartphones.

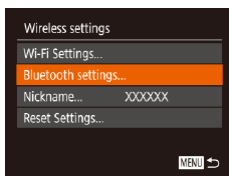

1 Choose [Bluetooth settings].

- Press the [MENU] button and choose [↑↑] tab > [Wireless settings] > [Bluetooth settings].

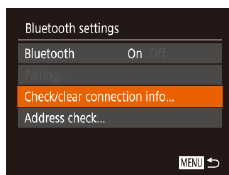

2 Choose [Check/clear connection info].

- Choose [Check/clear connection info], and then press the [Ⓜ] button.

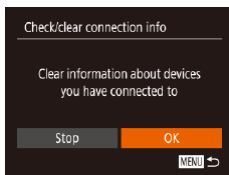

3 Clear the information.

- On the [Check/clear connection info] screen, press the [Ⓜ] button.
- After [Clear information about devices you have connected to] is displayed, press the [◀][▶] buttons or turn the [Ⓢ] dial to choose [OK], and then press the [Ⓜ] button.



4 Clear the camera information.

- In the Bluetooth setting menu on the smartphone, clear the camera information registered on the smartphone.

Before Use

Basic Guide

Advanced Guide

Camera Basics

Auto Mode / Hybrid Auto Mode

Other Shooting Modes

P Mode

Tv, Av, and M Mode

Playback Mode

Wireless Features

Setting Menu

Accessories

Appendix

Index

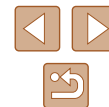

Setting Menu

Customize or adjust basic camera functions for greater convenience

Adjusting Basic Camera Functions

Basic camera functions are configured on the **[Fn]** tab of the MENU **[M]** (89). Customize commonly used functions as desired, for greater convenience.

Silencing Camera Operations

Silence camera sounds and movies as follows.

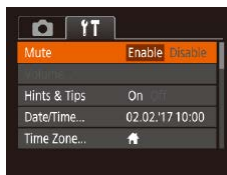

- Choose [Mute], and then choose [Enable].



- Operation can also be silenced by holding down the **iMENU** button as you turn the camera on.
- Sound is not played during movies **[M]** (87) if you mute camera sounds. To restore sound during movies, press the **[▲]** button. Adjust volume with the **[▲]**/**[▼]** buttons, as needed.

Adjusting the Volume

Adjust the volume of individual camera sounds as follows.



- Choose [Volume], and then press the **[Fn]** button.
- Choose an item, and then press the **[◀]**/**[▶]** buttons to adjust the volume.

Before Use

Basic Guide

Advanced Guide

Camera Basics

Auto Mode /
Hybrid Auto Mode

Other Shooting Modes

P Mode

Tv, Av, and M Mode

Playback Mode

Wireless Features

Setting Menu

Accessories

Appendix

Index

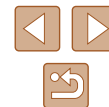

Hiding Hints and Tips

Hints and tips are normally shown when you choose FUNC. (📖28) or MENU (📖29) items. If you prefer, you can deactivate this information.

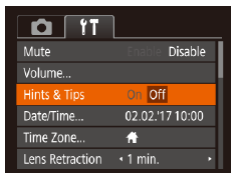

- Choose [Hints & Tips], and then choose [Off].

Date and Time

Adjust the date and time as follows.

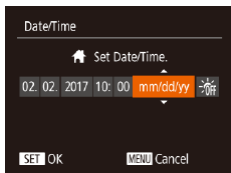

- Choose [Date/Time], and then press the [ⓘ] button.
- Press the [◀][▶] buttons to choose an item, and then adjust the setting, either by pressing the [▲][▼] buttons or turning the [🌀] dial.

World Clock

To ensure that your shots will have the correct local date and time when you travel abroad, simply register the destination in advance and switch to that time zone. This convenient feature eliminates the need to change the Date/Time setting manually.

Before using the world clock, be sure to set the date and time and your home time zone, as described in “Setting the Date and Time” (📖19).

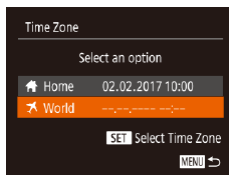

1 Specify your destination.

- Choose [Time Zone], and then press the [ⓘ] button.
- Press the [▲][▼] buttons or turn the [🌀] dial to choose [🌐 World], and then press the [ⓘ] button.
- Press the [◀][▶] buttons to choose the destination.
- To set daylight saving time (1 hour ahead), choose [🌞] by pressing the [▲][▼] buttons or turning the [🌀] dial, and then choose [🌞] by pressing the [◀][▶] buttons.
- Press the [ⓘ] button.

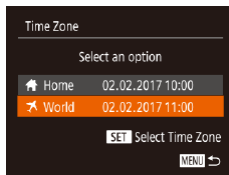

2 Switch to the destination time zone.

- Press the [▲][▼] buttons or turn the [🌀] dial to choose [🌐 World], and then press the [MENU] button.
- [🌐] is now shown on the shooting screen (📖170).



- Adjusting the date or time while in [🌐] mode (📖20) will automatically update your [🏠 Home] time and date.

Before Use

Basic Guide

Advanced Guide

Camera Basics

Auto Mode /
Hybrid Auto Mode

Other Shooting Modes

P Mode

Tv, Av, and M Mode

Playback Mode

Wireless Features

Setting Menu

Accessories

Appendix

Index



Lens Retraction Timing

The lens is normally retracted for safety about one minute after you press the [] button in Shooting mode (125). To have the lens retracted immediately after you press the [] button, set the retraction timing to [0 sec.].

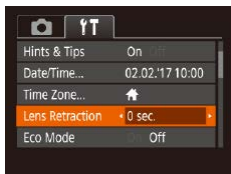

- Choose [Lens Retraction], and then choose [0 sec.].

Using Eco Mode

This function allows you to conserve battery power in Shooting mode. When the camera is not in use, the screen quickly darkens to reduce battery consumption.

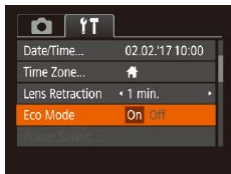

1 Configure the setting.

- Choose [Eco Mode], and then choose [On].
- [ECO] is now shown on the shooting screen (170).
- The screen darkens when the camera is not used for approximately two seconds; approximately ten seconds after darkening, the screen turns off. The camera turns off after approximately three minutes of inactivity.

2 Shoot.

- To activate the screen and prepare for shooting when the screen is off but the lens is still out, press the shutter button halfway.

Power-Saving Adjustment

Adjust the timing of automatic camera and screen deactivation (Auto Power Down and Display Off, respectively) as needed (126).

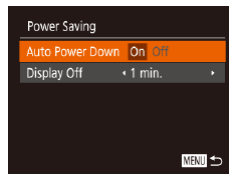

- Choose [Power Saving], and then press the [] button.
- After choosing an item, press the [][] buttons to adjust it as needed.



- To conserve battery power, you should normally choose [On] for [Auto Power Down] and [1 min.] or less for [Display Off].



- The [Display Off] setting is applied even if you set [Auto Power Down] to [Off].
- These power-saving functions are not available when you have set Eco mode (145) to [On].

Screen Brightness

Adjust screen brightness as follows.

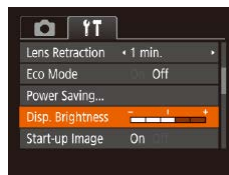

- Choose [Disp. Brightness], and then press the [][] buttons to adjust the brightness.

Before Use

Basic Guide

Advanced Guide

Camera Basics

Auto Mode /
Hybrid Auto Mode

Other Shooting Modes

P Mode

Tv, Av, and M Mode

Playback Mode

Wireless Features

Setting Menu

Accessories

Appendix

Index

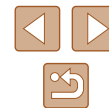



- For maximum brightness, press and hold the [▼] button for at least one second when the shooting screen is displayed or when in single-image display. (This will override the [Disp. Brightness] setting on the [↑↑] tab.) To restore the original brightness, press and hold the [▼] button again for at least one second or restart the camera.

Hiding the Start-Up Screen

If you prefer, you can deactivate display of the start-up screen normally shown when you turn the camera on.



- Choose [Start-up Image], and then choose [Off].

Formatting Memory Cards

Before using a new memory card or a card formatted in another device, you should format the card with this camera.

Formatting erases all data on a memory card. Before formatting, copy images on the memory card to a computer, or take other steps to back them up.

1 Access the [Format] screen.

- Choose [Format], and then press the [Ⓜ] button.

2 Choose [OK].

- Press the [◀][▶] buttons or turn the [⦿] dial to choose [OK], and then press the [Ⓜ] button.

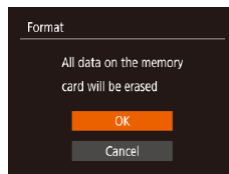
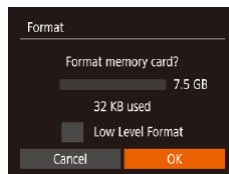

3 Format the memory card.

- To begin the formatting process, press the [▲][▼] buttons or turn the [⦿] dial to choose [OK], and then press the [Ⓜ] button.
- When formatting is finished, [Memory card formatting complete] is displayed. Press the [Ⓜ] button.



- Formatting or erasing data on a memory card only changes file management information on the card and does not erase the data completely. When transferring or disposing of memory cards, take steps to protect personal information if necessary, as by physically destroying cards.

- Before Use
- Basic Guide
- Advanced Guide
 - Camera Basics
 - Auto Mode / Hybrid Auto Mode
 - Other Shooting Modes
 - P Mode
 - Tv, Av, and M Mode
 - Playback Mode
 - Wireless Features
 - Setting Menu
 - Accessories
 - Appendix
- Index





- The total card capacity indicated on the formatting screen may be less than the advertised capacity.

Low-Level Formatting

Perform low-level formatting in the following cases: [Memory card error] is displayed, the camera is not working correctly, card image reading/writing is slower, continuous shooting is slower, or movie recording suddenly stops. Low-level formatting erases all data on a memory card. Before low-level formatting, copy images on the memory card to a computer, or take other steps to back them up.

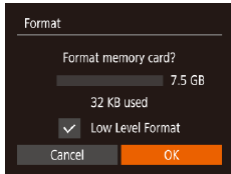

- On the screen in step 2 of “Formatting Memory Cards” (📖 146), press the [▲][▼] buttons or turn the [🔘] dial to choose [Low Level Format], and then press the [◀][▶] buttons to select this option. A [✓] icon is displayed.
- Follow steps 2 – 3 in “Formatting Memory Cards” (📖 146) to continue with the formatting process.



- Low-level formatting takes longer than “Formatting Memory Cards” (📖 146), because data is erased from all storage regions of the memory card.
- You can cancel low-level formatting in progress by choosing [Stop]. In this case, all data will be erased, but the memory card can be used normally.

File Numbering

Your shots are automatically numbered in sequential order (0001 – 9999) and saved in folders that store up to 2,000 images each. You can change how the camera assigns file numbers.



- Choose [File Numbering], and then choose the desired option.

Continuous	Images are numbered consecutively (until the 9999th shot is taken/saved) even if you switch memory cards.
Auto Reset	Image numbering is reset to 0001 if you switch memory cards, or when a new folder is created.



- Regardless of the option selected in this setting, shots may be numbered consecutively after the last number of existing images on newly inserted memory cards. To start saving shots from 0001, use an empty (or formatted, 📖 146) memory card.

Before Use

Basic Guide

Advanced Guide

Camera Basics

Auto Mode /
Hybrid Auto Mode

Other Shooting Modes

P Mode

Tv, Av, and M Mode

Playback Mode

Wireless Features

Setting Menu

Accessories

Appendix

Index



Date-Based Image Storage

Instead of saving images in folders created each month, you can have the camera create folders each day you shoot to store shots taken that day.

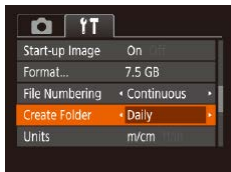

- Choose [Create Folder], and then choose [Daily].
- Images will now be saved in folders created on the shooting date.

Metric / Non-Metric Display

Change the unit of measurement shown in the zoom bar (📖33), the MF indicator (📖75), and elsewhere from m/cm to ft/in as needed.



- Choose [Units], and then choose [ft/in].

Checking Certification Logos

Some logos for certification requirements met by the camera can be viewed on the screen. Other certification logos are printed in this guide, on the camera packaging, or on the camera body.

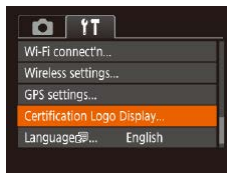

- Choose [Certification Logo Display], and then press the [📖] button.

Display Language

Change the display language as needed.



- Choose [Language] (📖), and then press the [📖] button.
- Press the [▲][▼][◀][▶] buttons or turn the [📖] dial to choose a language, and then press the [📖] button.



- You can also access the [Language] screen in Playback mode by pressing and holding the [📖] button and immediately pressing the [MENU] button.

Before Use
Basic Guide
Advanced Guide
Camera Basics
Auto Mode / Hybrid Auto Mode
Other Shooting Modes
P Mode
Tv, Av, and M Mode
Playback Mode
Wireless Features
Setting Menu
Accessories
Appendix
Index



Adjusting Other Settings

The following settings can also be adjusted on the [f] tab.

- [Video System] (152)
- [Wireless settings] (112)
- [GPS settings] (136)

Restoring Default Camera Settings

If you accidentally change a setting, you can restore default camera settings.

Restoring All Camera Defaults

1 Access the [Basic settings] screen.

- Choose [Reset camera] on the [f] tab, and then press the [OK] button.
- Choose [Basic settings], and then press the [OK] button.

2 Restore default settings.

- Press the [Left][Right] buttons or turn the [Dial] dial to choose [OK], and then press the [OK] button.
- All camera defaults are now restored.

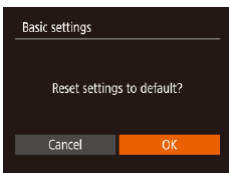

- The following functions are not restored to default settings.
 - Information registered using Face ID (45)
 - [f] tab settings [Date/Time] (144), [Time Zone] (144), [Language] (148), and [Video System] (152)
 - Custom white balance data you have recorded (73)
 - Shooting mode chosen in iSCN (59) mode
 - Movie mode (67)
 - Information registered in [Wireless settings] (112)

Restoring Defaults for Individual Functions

Settings for the following functions can be restored to defaults individually.

- Face ID information
- Wireless settings

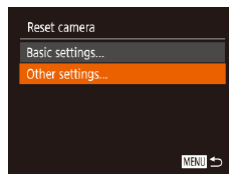

1 Access the [Other settings] screen.

- Choose [Reset camera] on the [f] tab, and then press the [OK] button.
- Choose [Other settings] and press the [OK] button.

2 Choose the function to reset.

- Choose the function to reset, and then press the [OK] button.

3 Restore default settings.

- Press the [Left][Right] buttons or turn the [Dial] dial to choose [OK], and then press the [OK] button.
- Default function settings are now restored.

Before Use

Basic Guide

Advanced Guide

Camera Basics

Auto Mode /
Hybrid Auto Mode

Other Shooting Modes

P Mode

Tv, Av, and M Mode

Playback Mode

Wireless Features

Setting Menu

Accessories

Appendix

Index



Accessories

Enjoy the camera in more ways with optional Canon accessories and other compatible accessories sold separately

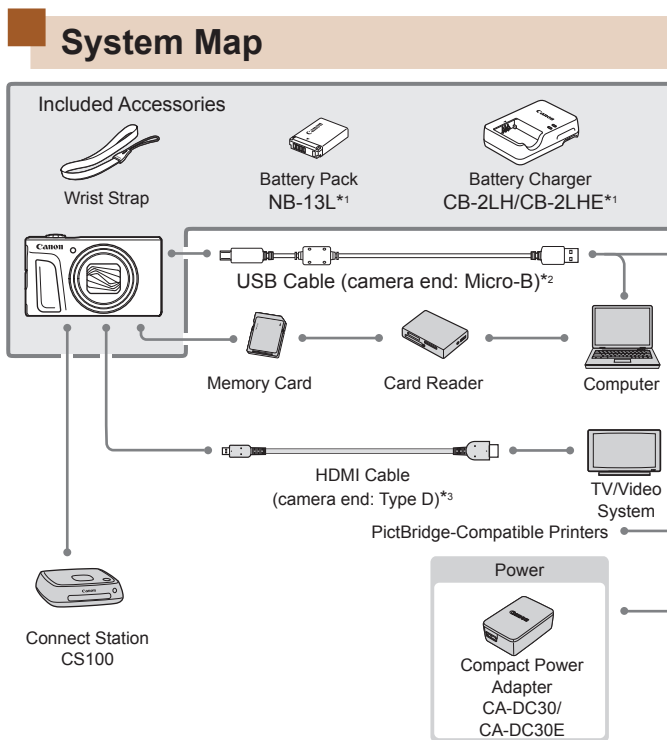

*¹ Also available for purchase separately.

*² A genuine Canon accessory is also available (Interface Cable IFC-600PCU).

*³ Use a commercially available cable no longer than 2.5 m (8.2 ft.).

Before Use

Basic Guide

Advanced Guide

Camera Basics

Auto Mode / Hybrid Auto Mode

Other Shooting Modes

P Mode

Tv, Av, and M Mode

Playback Mode

Wireless Features

Setting Menu

Accessories

Appendix

Index

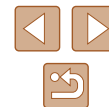

Use of genuine Canon accessories is recommended.

This product is designed to achieve excellent performance when used with genuine Canon accessories. Canon shall not be liable for any damage to this product and/or accidents such as fire, etc., caused by the malfunction of non-genuine Canon accessories (e.g., a leakage and/or explosion of a battery pack). Please note that any repairs your Canon product may require as a result of such malfunction are not covered under warranty and will incur a fee.

Optional Accessories

The following camera accessories are sold separately. Note that availability varies by area, and some accessories may no longer be available.

Power Supplies

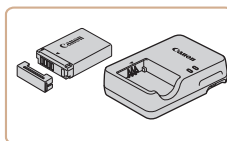

Battery Pack NB-13L

- Rechargeable lithium-ion battery

Battery Charger CB-2LH/CB-2LHE

- Charger for Battery Pack NB-13L



- The battery charger can be used in areas with 100 – 240 V AC power (50/60 Hz).
- For power outlets in a different format, use a commercially available adapter for the plug. Never use an electrical transformer designed for traveling, which may damage the battery pack.
- The message [Battery communication error] is displayed if you use a non-genuine Canon battery pack, and user response is required. Note that Canon shall not be liable for any damages resulting from accidents, such as malfunction or fire, that occur due to use of non-genuine Canon battery packs.



- The battery pack includes a convenient cover which you can attach to know the charge status at a glance. Attach the cover so that ▲ is visible on a charged battery pack, and attach it so that ▲ is not visible on an uncharged battery pack.

Before Use

Basic Guide

Advanced Guide

Camera Basics

Auto Mode /
Hybrid Auto Mode

Other Shooting Modes

P Mode

Tv, Av, and M Mode

Playback Mode

Wireless Features

Setting Menu

Accessories

Appendix

Index



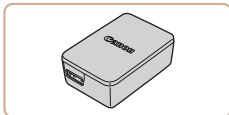

Compact Power Adapter CA-DC30/CA-DC30E

- Insert the included battery pack into the camera for charging. Interface Cable IFC-600PCU (sold separately) is required to connect the adapter to the camera.

Other Accessories

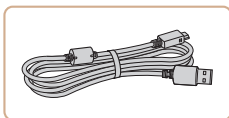

Interface Cable IFC-600PCU

- For connecting the camera to a computer or printer.

Printers

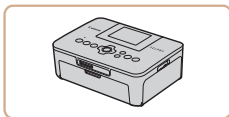

Canon-Brand PictBridge-Compatible Printers

- Even without using a computer, you can print images by connecting the camera directly to a printer. For details, visit your nearest Canon retailer.

Photo and Movie Storage

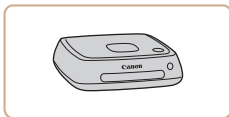

Connect Station CS100

- A media hub for storing camera images, viewing on a connected TV, printing wirelessly on a Wi-Fi-compatible printer, sharing over the Internet, and more.

Using Optional Accessories

▶ Still Images ▶ Movies

Playback on a TV

▶ Still Images ▶ Movies

By connecting the camera to a TV, you can view your shots on the larger screen of the TV.

For details on connection or how to switch inputs, refer to the TV manual.



- Some information may not be displayed when viewing images on a TV (📖171).

Playback on a High-Definition TV

▶ Still Images ▶ Movies

You can view your shots on a TV by connecting the camera to an HDTV with a commercially available HDMI cable (not exceeding 2.5 m / 8.2 ft., with a Type D terminal on the camera end). Movies shot at an image quality of [FHD 60P], [FHD 60P], or [HD 60P] can be viewed in high definition.

1 Make sure the camera and TV are off.

2 Connect the camera to the TV.

- On the TV, insert the cable plug fully into the HDMI input as shown.

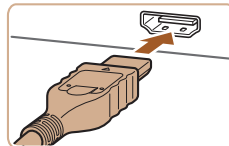

- Before Use
- Basic Guide
- Advanced Guide
 - Camera Basics
 - Auto Mode / Hybrid Auto Mode
 - Other Shooting Modes
 - P Mode
 - Tv, Av, and M Mode
 - Playback Mode
 - Wireless Features
 - Setting Menu
 - Accessories
 - Appendix
- Index

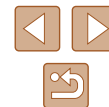

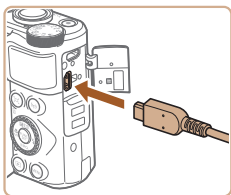

- On the camera, open the terminal cover and insert the cable plug fully into the camera terminal.

3 Turn the TV on and switch to external input.

- Switch the TV input to the external input you connected the cable to in step 2.

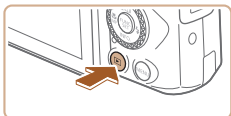

4 Turn the camera on.

- Press the [▶] button to turn the camera on.
- Images from the camera are now displayed on the TV. (Nothing is displayed on the camera screen.)
- When finished, turn off the camera and TV before disconnecting the cable.



- Camera operating sounds are not played while the camera is connected to an HDTV.

Inserting and Charging the Battery Pack

Charge the battery pack by using the supplied battery pack with an optional Compact Power Adapter CA-DC30/CA-DC30E and Interface Cable IFC-600PCU.

1 Insert the battery pack.

- Follow step 1 in “Inserting the Battery Pack and Your Memory Card” (18) to open the cover.
- Insert the battery pack as described in step 2 of “Inserting the Battery Pack and Your Memory Card” (19).
- Follow step 4 in “Inserting the Battery Pack and Your Memory Card” (19) to close the cover.

2 Connect the compact power adapter to the camera.

- With the camera turned off, open the cover (1). Hold the smaller plug of the interface cable (sold separately) facing as shown and insert the plug fully into the camera terminal (2).

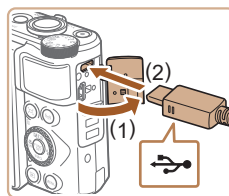

- Insert the larger plug of the interface cable into the compact power adapter.

Before Use

Basic Guide

Advanced Guide

Camera Basics

Auto Mode /
Hybrid Auto Mode

Other Shooting Modes

P Mode

Tv, Av, and M Mode

Playback Mode

Wireless Features

Setting Menu

Accessories

Appendix

Index



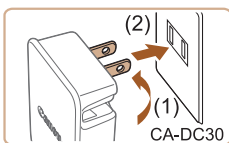

3 Charge the battery pack.

- CA-DC30: Flip out the plug (1) and plug the compact power adapter into a power outlet (2).

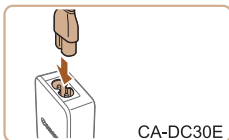

- CA-DC30E: Plug the power cord into the compact power adapter, then plug the other end into a power outlet.

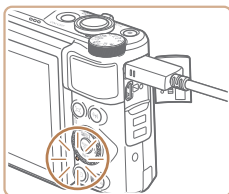

- Charging begins and the USB charge lamp lights up.
- The lamp turns off when charging finishes.
- Remove the compact power adapter from the power outlet and the interface cable from the camera.



- To protect the battery pack and keep it in optimal condition, do not charge it continuously for more than 24 hours.
- When charging another battery pack, always disconnect the interface cable from the camera before replacing the battery pack for charging.



- For details on charging time and the number of shots and recording time possible with a fully charged battery pack, see “Power” (183).
- You can view images even while the battery is charging, by turning the camera on and entering Playback mode (23). However, you cannot shoot while the battery is charging.
- If the USB charge lamp is not lit, reconnect the interface cable.
- Charged battery packs gradually lose their charge, even when they are not used. Charge the battery pack on (or immediately before) the day of use.
- The charger can be used in areas with 100 – 240 V AC power (50/60 Hz). For power outlets in a different format, use a commercially available adapter for the plug. Never use an electrical transformer designed for traveling, which may damage the battery pack.

- Before Use
- Basic Guide
- Advanced Guide
 - Camera Basics
 - Auto Mode / Hybrid Auto Mode
 - Other Shooting Modes
 - P Mode
 - Tv, Av, and M Mode
 - Playback Mode
 - Wireless Features
 - Setting Menu
 - Accessories
 - Appendix
- Index



Using a Computer to Charge the Battery

You can also charge the battery pack by inserting the larger plug of the interface cable into a computer's USB terminal in step 2 of "Inserting and Charging the Battery Pack" (📖153). For details about USB connections on the computer, refer to the computer user manual. We recommend using Interface Cable IFC-600PCU (sold separately).

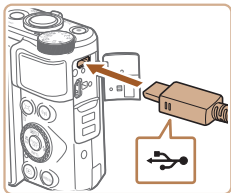

- With the camera turned off, open the cover. With the smaller plug of the cable in the orientation shown, insert the plug fully into the camera terminal.

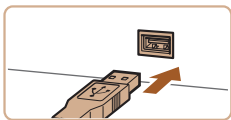

- Connect the larger cable plug to the computer. For details on computer connections, refer to the computer user manual.

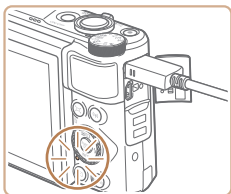

- Charging now begins, and the indicator on the back of the camera blinks in green. Charging will be finished in about four hours.
- However, charging may take longer if you import images on the camera to the computer, as described in "Saving Images to a Computer" (📖156).
- The indicator continues to blink in green even after charging is finished, as long as the camera is connected to the computer.



- Charging stops and the indicator goes off if, after you begin charging as described above, you press the power button to turn the camera off.
- With some computers, battery charging may require the memory card to be in the camera. Insert the memory card in the camera (📖18) before connecting the cable to the computer's USB port.

Using the Software

To utilize the features of the following software, download the software from the Canon website and install it on your computer.

- CameraWindow
 - Import images to your computer
- Image Transfer Utility
 - Set up Image Sync (📖134) and receive images
- Map Utility
 - Use a map to view GPS information that has been added to images



- To view and edit images on a computer, use preinstalled or commonly available software compatible with images captured by the camera.



- Image Transfer Utility can also be downloaded from the Image Sync settings page of CANON IMAGE GATEWAY.

Before Use

Basic Guide

Advanced Guide

Camera Basics

Auto Mode /
Hybrid Auto Mode

Other Shooting Modes

P Mode

Tv, Av, and M Mode

Playback Mode

Wireless Features

Setting Menu

Accessories

Appendix

Index



Computer Connections via a Cable

Checking Your Computer Environment

For detailed software system requirements and compatibility information (including support in new operating systems), visit the Canon website.

Installing the Software

Install the software as described in steps 1 – 2 of “Installing CameraWindow” (120).



- To uninstall (remove) the software in Mac OS, in the [Canon Utilities] folder within the [Applications] folder, drag the folder of the software for uninstallation to the Trash, and then empty the Trash.

Saving Images to a Computer

Using a USB cable (sold separately; camera end: Micro-B), you can connect the camera to the computer and save images to the computer.

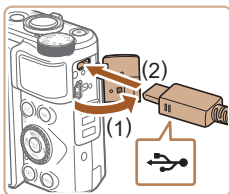

1 Connect the camera to the computer.

- With the camera turned off, open the cover (1). With the smaller plug of the USB cable in the orientation shown, insert the plug fully into the camera terminal (2).

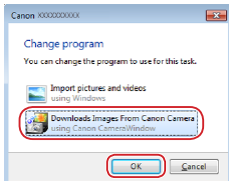
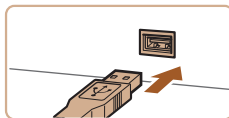

- Connect the larger cable plug to the computer. For details on computer connections, refer to the computer user manual.
- The camera automatically turns on when you connect it to the computer.

2 Display CameraWindow.

- Mac OS: CameraWindow is displayed when a connection is established between the camera and computer.
- Windows: Follow the steps introduced below.
- In the screen that is displayed, click the change program link of [].
- Choose [Downloads Images From Canon Camera] and then click [OK].

- Double-click [].

Before Use

Basic Guide

Advanced Guide

Camera Basics

Auto Mode /
Hybrid Auto Mode

Other Shooting Modes

P Mode

Tv, Av, and M Mode

Playback Mode

Wireless Features

Setting Menu

Accessories

Appendix

Index



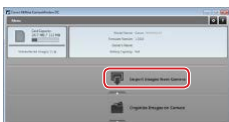

3 Save the images to the computer.

- Click [Import Images from Camera], and then click [Import Untransferred Images].
- Images are now saved to the Pictures folder on the computer, in separate folders named by date.
- After images are saved, close CameraWindow, press the [▶] button to turn the camera off, and unplug the cable.
- To view images you save to a computer, use preinstalled or commonly available software compatible with images captured by the camera.



- Windows 7: If the screen in step 2 is not displayed, click the [Camera] icon in the taskbar.
- Mac OS: If CameraWindow is not displayed after step 2, click the [CameraWindow] icon in the Dock.
- Although you can save images to a computer simply by connecting your camera to the computer without using the software, the following limitations apply.
 - It may take a few minutes after you connect the camera to the computer until camera images are accessible.
 - Images shot in vertical orientation may be saved in horizontal orientation.
 - Image protection settings may be cleared from images saved to a computer.
 - Some problems may occur when saving images or image information, depending on the operating system version, the software in use, or image file sizes.

Printing Images

▶ Still Images ▶ Movies

Your shots can easily be printed by connecting the camera to a printer. On the camera, you can specify images to set up batch printing, prepare orders for photo development services, and prepare orders or print images for photobooks.

A Canon SELPHY CP series compact photo printer is used here for the sake of illustration. Screens displayed and available functions vary by printer. Also refer to the printer manual for additional information.

Easy Print

▶ Still Images ▶ Movies

Print your shots by connecting the camera to a PictBridge-compatible printer with a USB cable (sold separately; camera end: Micro-B).

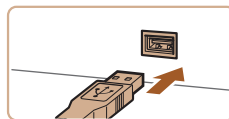
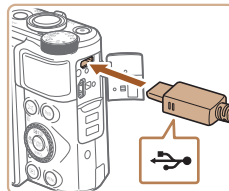

1 Make sure the camera and printer are off.

2 Connect the camera to the printer.

- Open the terminal cover. Holding the smaller cable plug in the orientation shown, insert the plug fully into the camera terminal.
- Connect the larger cable plug to the printer. For other connection details, refer to the printer manual.

3 Turn the printer on.

Before Use
Basic Guide
Advanced Guide
Camera Basics
Auto Mode / Hybrid Auto Mode
Other Shooting Modes
P Mode
Tv, Av, and M Mode
Playback Mode
Wireless Features
Setting Menu
Accessories
Appendix
Index



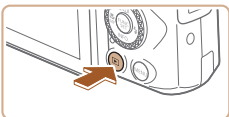

4 Turn the camera on.

- Press the [] button to turn the camera on.

5 Choose an image.

- Press the [][] buttons or turn the [] dial to choose an image.

6 Access the printing screen.

- Press the [] button, choose [], and press the [] button again.

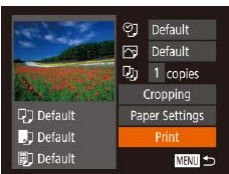

7 Print the image.

- Press the [][] buttons or turn the [] dial to choose [Print], and then press the [] button.
- Printing now begins.
- To print other images, repeat the above procedures starting from step 5 after printing is finished.
- When you are finished printing, turn the camera and printer off and disconnect the cable.



- For Canon-brand PictBridge-compatible printers (sold separately), see "Printers" (152).

Configuring Print Settings

► Still Images ► Movies

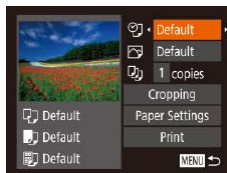

1 Access the printing screen.

- Follow steps 1 – 6 in "Easy Print" (157) to access this screen.

2 Configure the settings.

- Press the [][] buttons or turn the [] dial to choose an item, and then choose an option by pressing the [][] buttons.

🗨	Default	Matches current printer settings.
	Date	Prints images with the date added.
	File No.	Prints images with the file number added.
	Both	Prints images with both the date and file number added.
🖨	Off	–
	Default	Matches current printer settings.
	Off	–
	On	Uses information from the time of shooting to print under optimal settings.
👁	Red-Eye 1	Corrects red-eye.
	No. of Copies	Choose the number of copies to print.
Cropping	–	Specify a desired image area to print (159).
Paper Settings	–	Specify the paper size, layout, and other details (159).

Before Use
Basic Guide
Advanced Guide
Camera Basics
Auto Mode / Hybrid Auto Mode
Other Shooting Modes
P Mode
Tv, Av, and M Mode
Playback Mode
Wireless Features
Setting Menu
Accessories
Appendix
Index

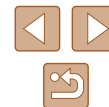

Cropping Images before Printing

► Still Images ► Movies

By cropping images before printing, you can print a desired image area instead of the entire image.

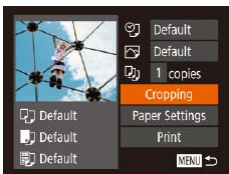

1 Choose [Cropping].

- After following step 1 in “Configuring Print Settings” (158) to access the printing screen, choose [Cropping] and press the **[OK]** button.
- A cropping frame is now displayed, indicating the image area to print.



2 Adjust the cropping frame as needed.

- To resize the frame, move the zoom lever.
- To move the frame, press the **[▲][▼][◀][▶]** buttons.
- To rotate the frame, turn the **[DISP]** dial.
- When finished, press the **[OK]** button.

3 Print the image.

- Follow step 7 in “Easy Print” (157) to print.



- Cropping may not be possible at small image sizes, or at some aspect ratios.
- Dates may not be printed correctly if you crop images shot with [Date Stamp] selected.

Choosing Paper Size and Layout before Printing

► Still Images ► Movies

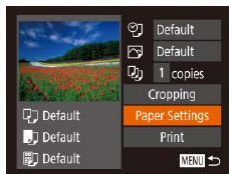

1 Choose [Paper Settings].

- After following step 1 in “Configuring Print Settings” (158) to access the printing screen, choose [Paper Settings] and press the **[OK]** button.

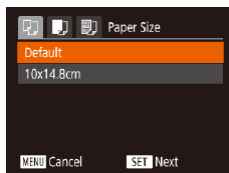

2 Choose a paper size.

- Press the **[▲][▼]** buttons or turn the **[DISP]** dial to choose an option, and then press the **[OK]** button.

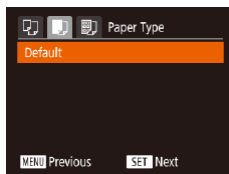

3 Choose a type of paper.

- Press the **[▲][▼]** buttons or turn the **[DISP]** dial to choose an option, and then press the **[OK]** button.

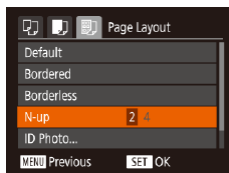

4 Choose a layout.

- Press the **[▲][▼]** buttons or turn the **[DISP]** dial to choose an option.
- When choosing [N-up], press the **[◀][▶]** buttons to specify the number of images per sheet.
- Press the **[OK]** button.

5 Print the image.

Before Use
Basic Guide
Advanced Guide
Camera Basics
Auto Mode / Hybrid Auto Mode
Other Shooting Modes
P Mode
Tv, Av, and M Mode
Playback Mode
Wireless Features
Setting Menu
Accessories
Appendix
Index



Available Layout Options

Default	Matches current printer settings.
Bordered	Prints with blank space around the image.
Borderless	Borderless, edge-to-edge printing.
N-up	Choose how many images to print per sheet.
ID Photo	Prints images for identification purposes. Only available for images with a recording pixel setting of L and an aspect ratio of 4:3.
Fixed Size	Choose the print size. Choose from 3.5 x 5 in., postcard, or wide-format prints.

Printing ID Photos

▶ Still Images ▶ Movies

1 Choose [ID Photo].

- Following steps 1 – 4 in “Choosing Paper Size and Layout before Printing” (📖 159), choose [ID Photo] and press the [OK] button.

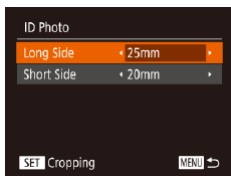

2 Choose the long and short side length.

- Press the [▲][▼] buttons or turn the [DISP] dial to choose an item. Choose the length by pressing the [◀][▶] buttons, and then press the [OK] button.

3 Choose the printing area.

- Follow step 2 in “Cropping Images before Printing” (📖 159) to choose the printing area.

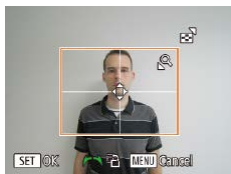

4 Print the image.

Printing Movie Scenes

▶ Still Images ▶ Movies

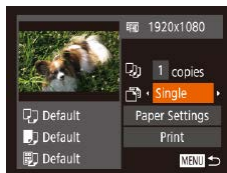

1 Access the printing screen.

- Follow steps 1 – 6 in “Easy Print” (📖 157) to choose a movie. The screen at left is displayed.

2 Choose a printing method.

- Press the [▲][▼] buttons or turn the [DISP] dial to choose [Single], and then press the [◀][▶] buttons to choose the printing method.

3 Print the image.

Movie Printing Options

Single	Prints the current scene as a still image.
Sequence	Prints a series of scenes, a certain interval apart, on a single sheet of paper. You can also print the folder number, file number, and elapsed time for the frame by setting [Caption] to [On].



- To cancel printing in progress, press the [DISP] button, choose [OK], and then press the [DISP] button again.
- After displaying a scene to print as described in steps 2 – 5 of “Viewing” (📖 87), you can also access the screen in step 1 here by pressing the [◀][▶] buttons to choose [Print] in the movie control panel and then pressing the [DISP] button.

Before Use
Basic Guide
Advanced Guide
Camera Basics
Auto Mode / Hybrid Auto Mode
Other Shooting Modes
P Mode
Tv, Av, and M Mode
Playback Mode
Wireless Features
Setting Menu
Accessories
Appendix
Index

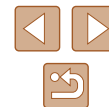

Adding Images to the Print List (DPOF)

▶ Still Images ▶ Movies

Batch printing (162) and ordering prints from a photo development service can be set up on the camera. Choose up to 998 images on a memory card and configure relevant settings, such as the number of copies, as follows. The printing information you prepare this way will conform to DPOF (Digital Print Order Format) standards.

Configuring Print Settings

▶ Still Images ▶ Movies

Specify the printing format, whether to add the date or file number, and other settings as follows. These settings apply to all images in the print list.

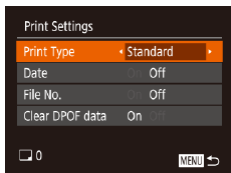

- Press the [MENU] button, and then choose [Print Settings] on the [D] tab. Choose and configure items as desired (29).

Print Type	Standard	One image is printed per sheet.
	Index	Smaller versions of multiple images are printed per sheet.
	Both	Both standard and index formats are printed.
Date	On	Images are printed with the shooting date.
	Off	–
File No.	On	Images are printed with the file number.
	Off	–
Clear DPOF data	On	All image print list settings are cleared after printing.
	Off	–



- Not all of your DPOF settings may be applied in printing by the printer or photo development service, in some cases.
- [!] may be displayed on the camera to warn you that the memory card has print settings that were configured on another camera. Changing the print settings using this camera may overwrite all previous settings.



- Specifying [Index] will prevent you from choosing [On] for both [Date] and [File No.] at the same time.
- Index printing is not available on some Canon-brand PictBridge-compatible printers (sold separately).
- The date is printed in a format matching setting details in [Date/Time] on the [T] tab (19).

Setting Up Printing for Individual Images

▶ Still Images ▶ Movies

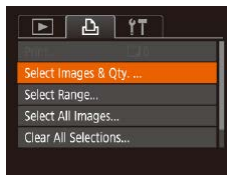

1 Choose [Select Images & Qty.].

- Press the [MENU] button, choose [Select Images & Qty.] on the [D] tab, and then press the [OK] button.

2 Choose an image.

- Press the [Left] [Right] buttons or turn the [Dial] to choose an image, and then press the [OK] button.
- You can now specify the number of copies.
- If you specify index printing for the image, it is labeled with a [✓] icon. To cancel index printing for the image, press the [OK] button again. [✓] is no longer displayed.

Before Use
Basic Guide
Advanced Guide
Camera Basics
Auto Mode / Hybrid Auto Mode
Other Shooting Modes
P Mode
Tv, Av, and M Mode
Playback Mode
Wireless Features
Setting Menu
Accessories
Appendix
Index





3 Specify the number of prints.

- Press the [▲][▼] buttons or turn the [DISP] dial to specify the number of prints (up to 99).
- To set up printing for other images and specify the number of prints, repeat steps 2 – 3.
- Printing quantity cannot be specified for index prints. You can only choose which images to print, by following step 2.
- When finished, press the [MENU] button to return to the menu screen.

Setting Up Printing for a Range of Images

▶ Still Images ▶ Movies



- Following step 1 in “Setting Up Printing for Individual Images” (161), choose [Select Range] and press the [DISP] button.
- Follow steps 2 – 3 in “Selecting a Range” (97) to specify images.
- Press the [▲][▼] buttons to choose [Order], and then press the [DISP] button.

Setting Up Printing for All Images

▶ Still Images ▶ Movies

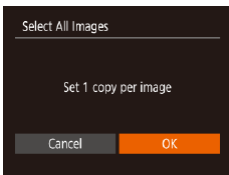

- Following step 1 in “Setting Up Printing for Individual Images” (161), choose [Select All Images] and press the [DISP] button.
- Press the [◀][▶] buttons or turn the [DISP] dial to choose [OK], and then press the [DISP] button.

Clearing All Images from the Print List

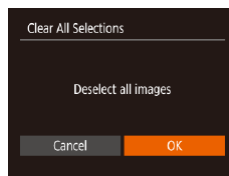

- Following step 1 in “Setting Up Printing for Individual Images” (161), choose [Clear All Selections] and press the [DISP] button.
- Press the [◀][▶] buttons or turn the [DISP] dial to choose [OK], and then press the [DISP] button.

Printing Images Added to the Print List (DPOF)

▶ Still Images ▶ Movies

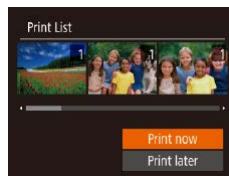

- When images have been added to the print list (161 – 162), this screen is displayed after you connect the camera to a PictBridge-compatible printer. Press the [▲][▼] buttons to choose [Print now], and then simply press the [DISP] button to print the images in the print list.
- Any DPOF print job that you temporarily stop will be resumed from the next image.

Before Use
Basic Guide
Advanced Guide
Camera Basics
Auto Mode / Hybrid Auto Mode
Other Shooting Modes
P Mode
Tv, Av, and M Mode
Playback Mode
Wireless Features
Setting Menu
Accessories
Appendix
Index

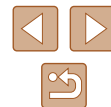

Adding Images to a Photobook

▶ Still Images ▶ Movies

Photobooks can be set up on the camera by choosing up to 998 images on a memory card and transferring them into the software on your computer, where they are stored in their own folder. This is convenient when ordering printed photobooks online or printing photobooks with your own printer.

Choosing a Selection Method

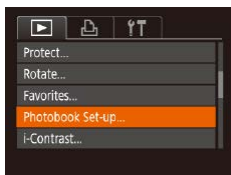

- Press the [MENU] button, choose [Photobook Set-up] on the [▶] tab, and then choose how you will select images.



- [!] may be displayed on the camera to warn you that the memory card has print settings that were configured on another camera. Changing the print settings using this camera may overwrite all previous settings.

Adding Images Individually

▶ Still Images ▶ Movies

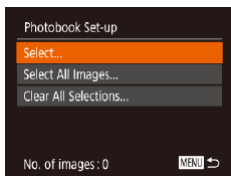

1 Choose [Select].

- Following the procedure in “Choosing a Selection Method” (163), choose [Select] and press the [OK] button.



2 Choose an image.

- Press the [◀][▶] buttons or turn the [DIAL] dial to choose an image, and then press the [OK] button.
- [✓] is displayed.
- To remove the image from the photobook, press the [OK] button again. [✓] is no longer displayed.
- Repeat this process to specify other images.
- When finished, press the [MENU] button to return to the menu screen.

Adding All Images to a Photobook

▶ Still Images ▶ Movies

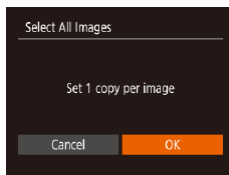

- Following the procedure in “Choosing a Selection Method” (163), choose [Select All Images] and press the [OK] button.
- Press the [◀][▶] buttons or turn the [DIAL] dial to choose [OK], and then press the [OK] button.

Removing All Images from a Photobook

▶ Still Images ▶ Movies

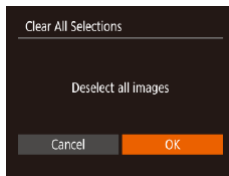

- Following the procedure in “Choosing a Selection Method” (163), choose [Clear All Selections] and press the [OK] button.
- Press the [◀][▶] buttons or turn the [DIAL] dial to choose [OK], and then press the [OK] button.

Before Use
Basic Guide
Advanced Guide
Camera Basics
Auto Mode / Hybrid Auto Mode
Other Shooting Modes
P Mode
Tv, Av, and M Mode
Playback Mode
Wireless Features
Setting Menu
Accessories
Appendix
Index

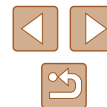

Appendix

Helpful information when using the camera

Troubleshooting

If you think there is a problem with the camera, first check the following. If the items below do not solve your problem, contact a Canon Customer Support Help Desk.

Power

Nothing happens when the power button is pressed.

- Confirm that the battery pack is charged (18).
- Confirm that the battery pack is inserted facing the correct way (18).
- Confirm that the memory card/battery cover is fully closed (18).
- Dirty battery terminals reduce battery performance. Try cleaning the terminals with a cotton swab and reinserting the battery pack a few times.

The battery pack runs out of power quickly.

- Battery performance decreases at low temperatures. Try warming the battery pack a little by putting it in your pocket, for example, ensuring that the terminals do not touch any metal objects.
- Dirty battery terminals reduce battery performance. Try cleaning the terminals with a cotton swab and reinserting the battery pack a few times.
- If these measures do not help and the battery pack still runs out of power soon after charging, it has reached the end of its life. Purchase a new battery pack.

The lens is not retracted.

- Do not open the memory card/battery cover while the camera is on. Close the cover, turn the camera on, and then turn it off again (18).

The battery pack is swollen.

- Battery swelling is normal and does not pose any safety concerns. However, if battery swelling prevents the battery pack from fitting in the camera, contact a Canon Customer Support Help Desk.

Display on a TV

Camera images look distorted or are not displayed on a TV (152).

Before Use

Basic Guide

Advanced Guide

Camera Basics

Auto Mode /
Hybrid Auto Mode

Other Shooting Modes

P Mode

Tv, Av, and M Mode

Playback Mode

Wireless Features

Setting Menu

Accessories

Appendix

Index

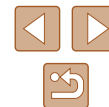

Shooting

Cannot shoot.

- In Playback mode (📖87), press the shutter button halfway (📖26).

Strange display on the screen under low light (📖27).

Strange display on the screen when shooting.

- Note that the following display problems are not recorded in still images but are recorded in movies.
 - The screen may flicker and horizontal banding may appear under fluorescent or LED lighting.

Full-screen display is not available while shooting (📖50).

No date stamp is added to images.

- Configure the [Date Stamp] (📖) setting (📖42). Note that date stamps are not added to images automatically, merely because you have configured the [Date/Time] setting (📖19).
- Date stamps are not added in shooting modes (📖178) in which [Date Stamp] (📖) cannot be configured (📖42).

⚡ flashes on the screen when the shutter button is pressed, and shooting is not possible (📖36).

📷 is displayed when the shutter button is pressed halfway (📖36).

- Set [IS Mode] to [Continuous] (📖83).
- Raise the flash and set the flash mode to ⚡ (📖81).
- Increase the ISO speed (📖72).
- Mount the camera on a tripod or take other measures to keep it still. Additionally, you should set [IS Mode] to [Off] when using a tripod or other means to secure the camera (📖83).

Shots are out of focus.

- Press the shutter button halfway to focus on subjects before pressing it all the way down to shoot (📖26).
- Make sure subjects are within focusing range (📖181).
- Set [AF-assist Beam] to [On] (📖54).
- Confirm that unneeded functions such as macro are deactivated.
- Try shooting with focus lock or AF lock (📖77, 📖80).

No AF frames are displayed and the camera does not focus when the shutter button is pressed halfway.

- To have AF frames displayed and the camera focus correctly, try composing the shot with higher-contrast subject areas centered before you press the shutter button halfway. Otherwise, try pressing the shutter button halfway repeatedly.

Subjects in shots look too dark.

- Raise the flash and set the flash mode to ⚡ (📖81).
- Adjust brightness by using exposure compensation (📖71).
- Adjust contrast by using i-Contrast (📖72, 📖104).
- Use AE lock or spot metering (📖71, 📖71).

Subjects look too bright, highlights are washed-out.

- Lower the flash and set the flash mode to ☀️ (📖33).
- Adjust brightness by using exposure compensation (📖71).
- Use AE lock or spot metering (📖71, 📖71).
- Reduce the lighting on subjects.

Shots look too dark despite the flash firing (📖36).

- Shoot within flash range (📖181).
- Adjust brightness by using flash exposure compensation or changing the flash output level (📖82, 📖86).
- Increase the ISO speed (📖72).

Subjects in flash shots look too bright, highlights are washed-out.

- Shoot within flash range (📖181).
- Lower the flash and set the flash mode to ☀️ (📖33).
- Adjust brightness by using flash exposure compensation or changing the flash output level (📖82, 📖86).

White spots appear in flash shots.

- This is caused by light from the flash reflecting off dust or airborne particles.

Shots look grainy.

- Lower the ISO speed (📖72).
- High ISO speeds in some shooting modes may cause grainy images (📖59).

Subjects are affected by red-eye.

- Set [Red-Eye Lamp] to [On] (📖54). The red-eye reduction lamp (📖4) will light up for flash shots. For best results, have subjects look at the red-eye reduction lamp. Also try increasing the lighting in indoor scenes and shooting at closer range.
- Edit images using red-eye correction (📖104).

Before Use

Basic Guide

Advanced Guide

Camera Basics

Auto Mode /
Hybrid Auto Mode

Other Shooting Modes

P Mode

Tv, Av, and M Mode

Playback Mode

Wireless Features

Setting Menu

Accessories

Appendix

Index



Recording to the memory card takes too long, or continuous shooting is slower.

- Use the camera to perform low-level formatting of the memory card (📖147).

Shooting settings or FUNC. menu settings are not available.

- Available setting items vary by shooting mode. Refer to “Functions Available in Each Shooting Mode”, “FUNC. Menu”, and “Shooting Tab” (📖172 – 📖175).

The Babies or Children icon is not displayed.

- The Babies and Children icons will not be displayed if the birthday is not set in face information (📖45). If the icons still are not displayed even when you set the birthday, re-register face information (📖46), or make sure that the date/time is set correctly (📖144).

Shooting Movies

The elapsed time shown is incorrect, or recording is interrupted.

- Use the camera to format the memory card, or switch to a card that supports high-speed recording. Note that even if the elapsed time display is incorrect, the length of movies on the memory card corresponds to the actual recording time (📖146, 📖182).

📢 is displayed and shooting stops automatically.

- The camera’s internal memory buffer filled up as the camera could not record to the memory card quickly enough. Try one of the following measures.
 - Use the camera to perform low-level formatting of the memory card (📖147).
 - Lower the image quality (📖51).
 - Switch to a memory card that supports high-speed recording (📖182).

Zooming is not possible.

- Zooming is not possible when shooting movies in [📷] (📖62), [📷] (📖69), and [📷]] (📖56) modes.

Subjects look distorted.

- Subjects that pass in front of the camera quickly may look distorted. This is not a malfunction.

Playback

Playback is not possible.

- Image or movie playback may not be possible if a computer is used to rename files or alter the folder structure.

Playback stops, or audio skips.

- Switch to a memory card that you have performed low-level formatting on with the camera (📖147).
- There may be brief interruptions when playing movies copied to memory cards that have slow read speeds.
- When movies are played on a computer, frames may be dropped and audio may skip if computer performance is inadequate.

Sound is not played during movies.

- Adjust the volume (📖143) if you have activated [Mute] (📖143) or the sound in the movie is faint.
- No sound is played for movies shot in [📷] (📖62), [📷] (📖69), or [📷]] (📖56) mode because audio is not recorded in these modes.

Cannot access the Story Highlights home screen by pressing the [▲] button.

- Home screen display is not possible when connected to a printer. Disconnect the camera from the printer.
- Home screen display is not possible during Wi-Fi connections. End the Wi-Fi connection.

A desired subject icon for an album is not displayed on the Story Highlights home screen.

- In simple information display mode (📖88), choose an image that shows the name of the person for the album before accessing the Story Highlights home screen (📖108).

Memory Card

The memory card is not recognized.

- Restart the camera, with the memory card in it (📖25).

Computer

Cannot transfer images to a computer.

- When attempting to transfer images to the computer via a cable, try reducing the transfer speed as follows.
 - Press the [▶] button to enter Playback mode. Hold the [MENU] button down as you press the [▲] and [📷] buttons at the same time. On the next screen, press the [◀] [▶] buttons to choose [B], and then press the [📷] button.

Before Use

Basic Guide

Advanced Guide

Camera Basics

Auto Mode / Hybrid Auto Mode

Other Shooting Modes

P Mode

Tv, Av, and M Mode

Playback Mode

Wireless Features

Setting Menu

Accessories

Appendix

Index



Wi-Fi

Cannot access the Wi-Fi menu by pressing the **[Wi-Fi]** button.

- The Wi-Fi menu cannot be accessed while the camera is connected to a printer or computer via a cable. Disconnect the cable.

Cannot add a device/destination.

- A total of 20 items of connection information can be added to the camera. Erase unneeded connection information from the camera first, and then add new devices/destinations (139).
- Use a computer or smartphone to register Web services (126).
- To add a smartphone, first install the dedicated application Camera Connect on your smartphone (117).
- To add a computer, first install the software CameraWindow on your computer. Also check your computer and Wi-Fi environment and settings (120, 122).
- Do not use the camera near sources of Wi-Fi signal interference such as microwave ovens or other equipment operating on the 2.4 GHz band.
- Bring the camera closer to the other device you are trying to connect to (such as the access point), and make sure there are no objects between the devices.

Cannot connect to the access point.

- Confirm that the access point channel is set to a channel supported by the camera (183). Note that instead of auto channel assignment, it is advisable to specify a supported channel manually.

Cannot send images.

- The destination device has insufficient storage space. Increase the storage space on the destination device and resend the images.
- The write-protect switch of the memory card in the destination camera is set to the locked position. Slide the write-protect switch to the unlocked position.
- Images are not sent to CANON iMAGE GATEWAY or other Web services if you move or rename image files or folders on the computer that received images sent using Image Sync via an access point (134). Before moving or renaming these image files or folders on the computer, make sure the images have already been sent to CANON iMAGE GATEWAY or other Web services.

Cannot resize images for sending.

- Images cannot be resized to be bigger than the recording pixel setting of their original size.
- Movies cannot be resized.

Images take a long time to send./The wireless connection is disrupted.

- Multiple images may take a long time to send. Try resizing the image to reduce sending time (134).
- Movies may take a long time to send.
- Do not use the camera near sources of Wi-Fi signal interference such as microwave ovens or other equipment operating on the 2.4 GHz band. Note that images may take a long time to send even when **[Wi-Fi]** is displayed.
- Bring the camera closer to the other device you are trying to connect to (such as the access point), and make sure there are no objects between the devices.

No notification message is received on a computer or smartphone after adding CANON iMAGE GATEWAY to the camera.

- Make sure the email address you entered is correct, and try adding the destination again.
- Check the email settings on the computer or smartphone. If they are configured to block email from certain domains, you may not be able to receive the notification message.

Want to erase Wi-Fi connection information before disposing of the camera or giving it to someone else.

- Reset the Wi-Fi settings (141).

Before Use

Basic Guide

Advanced Guide

Camera Basics

Auto Mode /
Hybrid Auto Mode

Other Shooting Modes

P Mode

Tv, Av, and M Mode

Playback Mode

Wireless Features

Setting Menu

Accessories

Appendix

Index

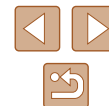

On-Screen Messages

If an error message is displayed, respond as follows.

Shooting or Playback

No memory card

- The memory card may be inserted facing the wrong way. Reinsert the memory card facing the correct way (118).

Memory card locked

- The write-protect switch of the memory card is set to the locked position. Switch the write-protect switch to the unlocked position (118).

Cannot record!

- Shooting was attempted without a memory card in the camera. To shoot, insert a memory card facing the correct way (118).

Memory card error (147)

- If the same error message is displayed even after you have formatted a supported memory card (12) and have inserted it facing the correct way (118), contact a Canon Customer Support Help Desk.

Insufficient space on card

- There is not enough free space on the memory card to shoot (133, 156, 170, 184) or edit images (102). Either erase unneeded images (198) or insert a memory card with enough free space (118).

Charge the battery (118)

No Image.

- The memory card does not contain any images that can be displayed.

Protected! (196)

Unidentified Image/Incompatible JPEG/Image too large./Cannot play back MOV/Cannot play back MP4

- Unsupported or corrupt images cannot be displayed.
- It may not be possible to display images that were edited or renamed on a computer, or images shot with another camera.

Cannot magnify!/Cannot play back this content in Smart Shuffle/Cannot rotate/Cannot modify image/Cannot modify/Unselectable image./No identification information

- The following functions may be unavailable for images that were renamed or already edited on a computer, or images shot with another camera. Note that starred (*) functions are not available for movies.
Edit ID Info* (193), Magnify* (194), Smart Shuffle* (195), Rotate* (100), Favorites (101), Edit* (102), Print List* (161), and Photobook Set-up* (163).

Invalid selection range

- When specifying a range for image selection (197, 199, 162), you attempted to choose an initial image that was after the final image, or vice-versa.

Exceeded selection limit

- More than 998 images were selected for Print List (161) or Photobook Set-up (163). Choose 998 images or less.
- Print List (161) or Photobook Set-up (163) settings could not be saved correctly. Reduce the number of selected images and try again.
- You attempted to choose more than 500 images in Protect (196), Erase (198), Favorites (101), Print List (161), or Photobook Set-up (163).

Naming error!

- The folder could not be created or images could not be recorded, because the highest supported folder number (999) for storing images on the card has been reached and the highest supported image number (9999) for images in folders has been reached. On the [Fn] tab, change [File Numbering] to [Auto Reset] (147), or format the memory card (146).

Lens Error

- This error may occur if the lens is held while it is moving, or when the camera is used in dusty or sandy locations.
- Frequent display of this error message may indicate damage. In this case, contact a Canon Customer Support Help Desk.

A camera error was detected (*error number*)

- If this error message is displayed immediately after a shot, the image may not have been saved. Switch to Playback mode to check for the image.
- Frequent display of this error message may indicate damage. In this case, write down the error number (*Exx*) and contact a Canon Customer Support Help Desk.

Before Use

Basic Guide

Advanced Guide

Camera Basics

Auto Mode /
Hybrid Auto Mode

Other Shooting Modes

P Mode

Tv, Av, and M Mode

Playback Mode

Wireless Features

Setting Menu

Accessories

Appendix

Index

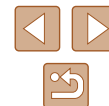

File Error

- Correct printing (📖 157) may not be possible for photos from other cameras or images that have been altered using computer software, even if the camera is connected to the printer.

Print error

- Check the paper size setting (📖 159). If this error message is displayed when the setting is correct, restart the printer and complete the setting on the camera again.

Ink absorber full

- Contact a Canon Customer Support Help Desk to request assistance with ink absorber replacement.

Wi-Fi

Connection failed

- No access points were recognized. Check the access point settings (📖 122).
- A device could not be found. Turn the camera off and on again, and retry the connection.
- Check the device you want to connect to and make sure it is ready for connection.

Cannot determine access point

- The WPS buttons on numerous access points were pressed simultaneously. Try reconnecting again.

No access points found

- Check to make sure that the access point is turned on.
- When connecting to an access point manually, make sure that you entered the correct SSID.

Incorrect password/Incorrect Wi-Fi security settings

- Check the access point security settings (📖 122).

IP address conflict

- Reset the IP address so that it does not conflict with another.

Disconnected/Receiving failed/Sending failed

- You may be in an environment where Wi-Fi signals are obstructed.
- Avoid using the camera's Wi-Fi function around microwave ovens and other devices that operate on the 2.4 GHz band.
- Bring the camera closer to the other device you are trying to connect to (such as the access point), and make sure there are no objects between the devices.
- Check the connected device to make sure it is not experiencing errors.

Sending failed

Memory card error

- If the same error message is displayed even when you have inserted a formatted memory card facing the correct way, contact a Canon Customer Support Help Desk.

Receiving failed

Insufficient space on card

- There is not enough free space on the memory card in the target camera to receive images. Erase images to create space on the memory card, or insert a memory card with sufficient space.

Receiving failed

Memory card locked

- The write-protect switch of the memory card in the camera to receive the images is set to the locked position. Slide the write-protect switch to the unlocked position.

Receiving failed

Naming error!

- When the highest folder number (999), and the highest image number (9999) have been reached on the receiving camera, images cannot be received.

Insufficient space on server

- Delete unnecessary images uploaded to CANON iMAGE GATEWAY to create space.
- Save the images sent via Image Sync (📖 134) to your computer.

Check network settings

- Check to make sure your computer can connect to the Internet with the current network settings.

Before Use

Basic Guide

Advanced Guide

Camera Basics

Auto Mode /
Hybrid Auto Mode

Other Shooting Modes

P Mode

Tv, Av, and M Mode

Playback Mode

Wireless Features

Setting Menu

Accessories

Appendix

Index



On-Screen Information

Shooting (Information Display)

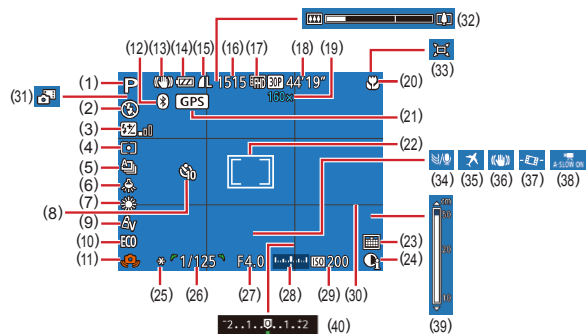

- | | |
|---|---|
| (1) Shooting mode (📖172), Scene icon (📖37) | (12) Bluetooth connection status (📖115) |
| (2) Flash mode (📖81) | (13) IS mode icon (📖38) |
| (3) Flash exposure compensation / Flash output level (📖82, 📖86) | (14) Battery level (📖170) |
| (4) Metering method (📖71) | (15) Still image compression (📖83), Recording pixel setting (📖50) |
| (5) Drive mode (📖80) | (16) Recordable shots (📖182)* |
| (6) Mercury lamp correction (📖51) | (17) Movie quality (📖51) |
| (7) White balance (📖73) | (18) Remaining time (📖182) |
| (8) Self-timer (📖43) | (19) Zoom magnification (📖39), Digital tele-converter (📖77) |
| (9) My Colors (📖74) | (20) Focus range (📖75, 📖75), AF lock (📖80) |
| (10) Eco mode (📖145) | (21) Connected via Bluetooth to a smartphone and acquiring GPS information (📖137) |
| (11) Camera shake warning (📖36) | |

- | | |
|--|--|
| (22) AF frame (📖77), Spot AE point frame (📖71) | (31) Hybrid Auto mode (📖35) |
| (23) Date stamp (📖42) | (32) Zoom bar (📖33) |
| (24) i-Contrast (📖72) | (33) 📺 Auto (📖40) |
| (25) AE lock (📖71), FE lock (📖82) | (34) Wind filter (📖68) |
| (26) Shutter speed (📖84, 📖85) | (35) Time zone (📖144) |
| (27) Aperture value (📖85, 📖85) | (36) Image stabilization (📖83) |
| (28) Exposure level (📖85) | (37) 📺 Auto level (📖52) |
| (29) ISO speed (📖72) | (38) 📺 Auto slow shutter (📖68) |
| (30) Grid lines (📖52) | (39) MF indicator (📖75) |
| | (40) Exposure compensation level (📖71) |

* In [📺] mode, indicates the number of shots available.

Battery Level

An on-screen icon or message indicates the battery charge level.

Display	Details
	Sufficient charge
	Slightly depleted, but sufficient
	Nearly depleted—charge the battery pack soon
[Charge the battery]	Depleted—charge the battery pack immediately

Before Use
Basic Guide
Advanced Guide
Camera Basics
Auto Mode / Hybrid Auto Mode
Other Shooting Modes
P Mode
Tv, Av, and M Mode
Playback Mode
Wireless Features
Setting Menu
Accessories
Appendix
Index



Playback (Detailed Information Display)

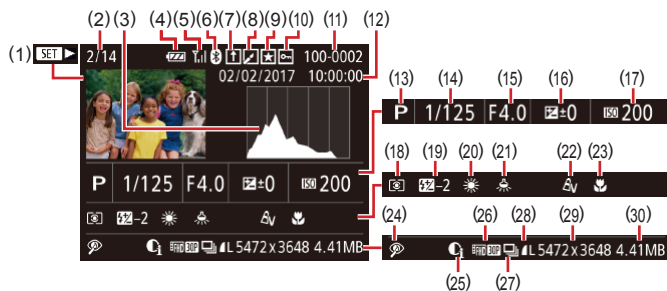

- | | |
|---|---|
| (1) Movie playback (83, 87), Digest movie playback (35) | (15) Aperture value (85, 85) |
| (2) Current image no. / Total no. of images | (16) Exposure compensation level (71) |
| (3) Histogram (89) | (17) ISO speed (72) |
| (4) Battery level (170) | (18) Metering method (71) |
| (5) Wi-Fi signal strength (133) | (19) Flash (81), Flash exposure compensation (82) |
| (6) Bluetooth connection status (115) | (20) White balance (73) |
| (7) Image Sync (134) | (21) Mercury lamp correction (51) |
| (8) Image editing (102), Movie compression (106) | (22) My Colors (74, 103), Creative Shot effect (57) |
| (9) Favorites (101) | (23) Focus range (75, 75) |
| (10) Protection (96) | (24) Red-eye correction (104), Short clip playback effect (69) |
| (11) Folder number - File number (147) | (25) i-Contrast (72) |
| (12) Shooting date/time (19) | (26) Image quality / Frame rate (movies) (50, 51), Albums (108) |
| (13) Shooting mode (172) | (27) Group playback (92) |
| (14) Shutter speed (84, 85) | |

- (28) Compression (image quality) (83) / Recording pixel setting (50, 51), MP4 (movies)
- (29) Still images: Recording pixel setting (182)
Movies: Playback time (182)
- (30) File size



- Some information may not be displayed when viewing images on a TV (152).

Summary of Movie Control Panel

The following operations are available on the movie control panel, accessed as described in "Viewing" (87).

	Play
	Slow Motion (To adjust the playback speed, press the [◀] [▶] buttons or turn the [DIAL] dial. No sound is played.)
	Skip Backward* or Previous Clip (107) (To continue skipping backward, keep holding down the [⏮] button.)
	Previous Frame (For fast-rewind, keep holding down the [⏪] button.)
	Next Frame (For fast-forward, keep holding down the [⏩] button.)
	Skip Forward* or Next Clip (107) (To continue skipping forward, keep holding down the [⏭] button.)
	Erase Clip (displayed when a digest movie, Creative Shot movie, or album movie is selected (107))
	Edit (105)
	Shown when the camera is connected to a PictBridge-compatible printer (157).

* Displays the frame approx. 4 sec. before or after the current frame.



- During movie playback, you can skip back or forward (or to the previous or next clip) by pressing the [◀] [▶] buttons.

Before Use
Basic Guide
Advanced Guide
Camera Basics
Auto Mode / Hybrid Auto Mode
Other Shooting Modes
P Mode
Tv, Av, and M Mode
Playback Mode
Wireless Features
Setting Menu
Accessories
Appendix
Index

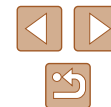

FUNC. Menu

	Shooting Mode											Function											
	M	Av	Tv	P		AUTO																	
Function																							
Light Metering (71)																							
	O	O	O	O	O	O	O	O	O	O	O	O	O	O	O	O	O	O	O	O	O	O	O
	O	O	O	O	-	-	-	-	-	-	-	-	-	-	-	-	-	-	-	-	-	-	-
My Colors (74)																							
OFF	O	O	O	O	O	O	O	O	O	O	O	O	O	O	O	O	O	O	O	O	O	O	O
Av / AvN / Ae*1 / Aw*1 / Ap / AL / AD / AB / AG / AR / Ac*2	O	O	O	O	-	-	-	-	-	-	O	O	O	-	-	-	-	-	-	-	-	-	O
White Balance (73)																							
AWB	O	O	O	O	O	O	O	O	O	O	O	O	O	O	O	O	O	O	O	O	O	O	O
	O	O	O	O	-	-	-	-	-	-	O	O	O	-	-	-	-	-	-	-	-	-	O
ISO Speed (72)																							
AUTO	-	O	O	O	O	O	O	O	O	O	O	O	O	O	O	O	O	O	O	O	O	O	O
80 / 100 / 200 / 400 / 800 / 1600 / 3200	O	O	O	O	-	-	-	-	-	-	-	-	-	-	-	-	-	-	-	-	-	-	-
Shooting Mode (59)																							
	-	-	-	-	-	-	-	-	O	O	O	O	O	O	O	O	O	O	O	O	O	O	O
Self-Timer (43)																							
	O	O	O	O	O	O	O	O	O	O	O	O	O	O	O	O	O	O	O	O	O	O	O
	O	O	O	O	O	O	O	O	O	O	-	-	-	O	O	O	O	O	O	O	O	O	O
Self-Timer Settings (44)																							
Delay*3	O	O	O	O	O	O	O	O	O	O	-	-	-	O	O	O	O	O	O	O	O	O	O
Shots*4	O	O	O	O	-	O	-	-	-	-	-	-	-	O	O	O	O	O	O	O	O	O	-
Flash Exposure Compensation (82)																							
	-	O	O	O	-	-	-	O	-	-	-	-	-	-	-	-	-	-	-	-	-	-	-
Flash Output Level (86)																							
	O	O	O	-	-	-	-	-	-	-	-	-	-	-	-	-	-	-	-	-	-	-	-

- *1 White balance is not available.
- *2 Set in a range of 1 – 5: contrast, sharpness, color saturation, red, green, blue, and skin tone.
- *3 Cannot be set to 0 seconds in modes without selection of the number of shots.
- *4 One shot (cannot be modified) in modes without selection of the number of shots.

O Available or set automatically. – Not available.

- Before Use
- Basic Guide
- Advanced Guide
 - Camera Basics
 - Auto Mode / Hybrid Auto Mode
 - Other Shooting Modes
 - P Mode
 - Tv, Av, and M Mode
 - Playback Mode
 - Wireless Features
 - Setting Menu
 - Accessories
 - Appendix
- Index



Function	Shooting Mode																Function Icons										
Drive Mode (80)	M	Av	Tv	P	MF	AUTO	AF-ON	AF-LOCK	AF-LOCK	AF-LOCK	AF-LOCK	AF-LOCK	AF-LOCK	AF-LOCK	AF-LOCK	AF-LOCK	AF-LOCK	AF-LOCK	AF-LOCK	AF-LOCK	AF-LOCK	AF-LOCK	AF-LOCK	AF-LOCK	AF-LOCK		
[]	O	O	O	O	O	O	O	O	O	O	O	O	O	O	O	O	O	O	O	O	O	O	O	O	O		
[A]	-	-	-	-	-	O	-	-	-	-	-	-	-	-	-	-	-	-	-	-	-	-	-	-	-		
[]	O	O	O	O	-	O	-	-	-	O	-	-	-	-	-	O	O	O	O	O	O	O	O	-	-		
[MF]*1	O	O	O	O	-	-	-	-	O	-	-	-	-	-	-	O	O	O	O	O	O	O	O	-	-		
Still Image Aspect Ratio (50)																											
16:9	O	O	O	O	-	O	-	-	O	O	O	O	O	O	-	-	O	-	-	-	O	O	O	O	*2	O	
3:2	O	O	O	O	-	O	-	-	O	O	O	O	O	O	-	-	O	-	-	-	-	O	O	O	-	-	
4:3	O	O	O	O	O	O	O	O	O	O	O	O	O	O	O	O	O	O	O	O	O	O	O	O	*2	-	
1:1	O	O	O	O	-	O	-	O	O	O	O	O	O	O	-	-	O	-	-	-	-	O	O	O	-	-	
Recording Pixels (50)																											
L	O	O	O	O	O	O	O	O	O	O	O	O	O	O	O	O	-	O	O	O	O	O	O	O	O	O	
M1/M2/S	O	O	O	O	-	O	-	-	O	O	-	O	O	O	-	-	-	-	-	-	-	-	-	-	O	O	
Compression (83)																											
S	O	O	O	O	-	-	-	-	-	-	-	-	-	-	-	-	-	-	-	-	-	-	-	-	-	-	
[]	O	O	O	O	O	O	O	O	O	O	O	O	O	O	O	O	O	O	O	O	O	O	O	O	O	O	
Movie Quality (51)																											
4K 60P	-	-	-	-	-	-	-	-	-	-	-	-	-	-	-	-	-	-	-	-	-	-	-	-	O	-	
4K 30P	O	O	O	O	O	O	-	O	O	O	O	O	O	O	O	O	O	O	O	O	O	O	O	-	O	O	
4K 30P	O	O	O	O	O	O	O	O	O	O	O	O	O	O	O	O	O	O	O	O	O	O	O	*3	O	O	
4K 30P	O	O	O	O	O	O	-	O	O	O	O	O	O	O	O	O	O	O	O	O	O	O	O	*3	O	O	

*1 [MF] is set with [MF], AF lock, or [AF-LOCK].

*2 Set automatically to suit the aspect ratio of the movie recording size.

*3 Synchronizes with the aspect ratio setting and is automatically set (62).

O Available or set automatically. - Not available.

- Before Use
- Basic Guide
- Advanced Guide
 - Camera Basics
 - Auto Mode / Hybrid Auto Mode
 - Other Shooting Modes
 - P Mode
 - Tv, Av, and M Mode
 - Playback Mode
 - Wireless Features
 - Setting Menu
 - Accessories
 - Appendix
- Index

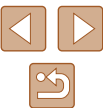

Shooting Tab

Function	Shooting Mode																				
	M	Av	Tv	P		AUTO															
AF Frame (77)																					
Face AiAF*1	O	O	O	O	O	O	O	O	-	O	O	O	O	O	O	O	O	O	-	O	O
Tracking AF	O	O	O	O	-	-	-	-	O	O	O	-	-	-	O	O	-	-	-	O	O
Center	O	O	O	O	-	-	-	-	O	O	O	-	-	-	O	O	O	O	O	O	O
AF Frame Size (77)*2																					
Normal	O	O	O	O	-	-	-	-	O	O	-	-	-	-	O	O	O	O	O	-	O
Small	O	O	O	O	-	-	-	-	O	O	-	-	-	-	O	O	O	-	O	-	O
Digital Zoom (39)																					
Standard	O	O	O	O	O	O	-	-	O	O	-	O	O	O	-	-	-	-	-	-	O
Off	O	O	O	O	O	O	O	O	O	O	O	O	O	O	-	O	O	O	O	O	O
1.6x/2.0x	O	O	O	O	-	-	-	-	-	-	-	-	-	-	-	-	-	-	-	-	-
Servo AF (79)																					
Enable	O	O	O	O	-	-	-	O	O	O	-	-	-	-	O	O	-	-	-	O	O
Disable	O	O	O	O	O	^{*3}	O	O	-	O	O	O	O	O	O	O	O	O	O	O	O
Continuous AF (79)																					
Enable	O	O	O	O	O	O	O	O	O	O	O	O	O	O	O	-	O	O	O	O	O
Disable	O	O	O	O	-	-	-	O	-	O	O	-	-	-	O	O	O	O	O	O	O

*1 Operation when no faces are detected varies by shooting mode.

*2 Available when the AF frame is set to [Center].

*3 [Enable] when subject movement is detected.

O Available or set automatically. - Not available.

- Before Use
- Basic Guide
- Advanced Guide
 - Camera Basics
 - Auto Mode / Hybrid Auto Mode
 - Other Shooting Modes
 - P Mode
 - Tv, Av, and M Mode
 - Playback Mode
 - Wireless Features
 - Setting Menu
 - Accessories
 - Appendix
- Index

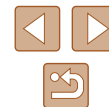

		Shooting Mode																				
Function		M	Av	Tv	P	📷	AUTO	📷	📷	📷	📷	📷	📷	📷	📷	📷	📷	📷	📷	📷	📷	📷
AF-assist Beam (📖54)																						
On		○	○	○	○	○	○	○	○	○	○	○	○	○	○	○	○	○	○	○	○	○
Off		○	○	○	○	○	○	○	○	○	○	○	○	○	○	○	○	○	○	○	○	○
MF-Point Zoom (📖75)																						
Off		○	○	○	○	○	○	○	○	○	○	○	○	○	○	○	○	○	○	○	○	○
2x/4x		○	○	○	○	-	-	-	-	○	-	-	-	-	○	○	-	-	-	-	○	○
Safety MF (📖75)																						
On		○	○	○	○	-	-	-	-	○	○	-	-	-	○	○	○	○	○	○	○	○
Off		○	○	○	○	○	○	○	○	○	○	○	○	○	○	○	○	○	○	○	○	○
MF Peaking Settings (📖76)																						
Peaking	On	○	○	○	○	-	-	-	-	○	○	-	-	-	○	○	○	○	○	○	○	○
	Off	○	○	○	○	○	○	○	○	○	○	○	○	○	○	○	○	○	○	○	○	○
Level	Low/High	○	○	○	○	-	-	-	-	○	○	-	-	-	○	○	○	○	○	○	○	○
Color	Red/Blue/Yellow	○	○	○	○	-	-	-	-	○	○	-	-	-	○	○	○	○	○	○	○	○
Flash settings (📖54, 📖82, 📖86)																						
Flash Mode	Auto	-	○	○	○	○	○	○	○	-	○	○	○	○	○	○	○	○	○	○	○	○
	Manual	○	○	○	-	-	-	-	-	-	-	-	-	-	-	-	-	-	-	-	-	-
Flash Exp. Comp	See "Flash Exposure Compensation" in "FUNC. Menu" (📖173).																					
Flash Output	See "Flash Output Level" in "FUNC. Menu" (📖173).																					
Red-Eye Lamp	On/Off	○	○	○	○	○	○	○	○	-	○	○	○	○	○	○	○	○	○	○	○	○
Safety FE	On	-	○	○	○	○	○	○	○	-	○	○	○	○	○	○	○	○	○	○	○	○
	Off	○	○	○	○	-	-	-	-	-	-	-	-	-	-	-	-	-	-	-	-	-
i-Contrast (📖72)																						
Auto		○	○	○	○	○	○	-	-	-	-	-	-	-	○	-	-	-	-	-	-	-
Off		○	○	○	○	-	-	○	-	○	○	-	○	○	○	○	○	○	○	○	○	○
Hg Lamp Corr. (📖51)																						
On		-	-	-	-	-	○	-	-	-	-	-	-	-	-	-	-	-	-	-	-	-
Off		○	○	○	○	○	○	○	○	○	○	○	○	○	○	○	○	○	○	○	○	○

○ Available or set automatically. - Not available.

- Before Use
- Basic Guide
- Advanced Guide
 - Camera Basics
 - Auto Mode / Hybrid Auto Mode
 - Other Shooting Modes
 - P Mode
 - Tv, Av, and M Mode
 - Playback Mode
 - Wireless Features
 - Setting Menu
 - Accessories
 - Appendix
- Index

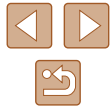

		Shooting Mode																									
		M	Av	Tv	P		AUTO																				
Function																											
Safety shift (85)																											
On		-	O	O	-	-	-	-	-	-	-	-	-	-	-	-	-	-	-	-	-	-	-	-			
Off		O	O	O	O	O	O	O	O	O	O	O	O	O	O	O	O	O	O	O	O	O	O	O			
Wind Filter (68)																											
Auto		O	O	O	O	O	-	O	O	O	O	O	O	O	O	O	O	O	O	-	O	O	O	-			
Off		O	O	O	O	-	-	O	-	-	-	-	-	-	-	-	-	-	-	O	-	-	-	O			
Attenuator (68)																											
Off/On		O	O	O	O	-	-	-	-	-	-	-	-	-	-	-	-	-	-	-	-	-	O	-			
Auto		O	O	O	O	O	O	O	O	O	O	O	O	O	O	O	O	O	O	O	O	O	O	O			
Auto slow shutter (68)																											
Disable		O	O	O	O	O	O	O	O	O	O	O	O	O	O	O	O	O	O	O	O	O	O	O			
Enable		-	-	-	-	-	-	-	-	-	-	-	-	-	-	-	-	-	-	-	-	-	O	-			
Review image after shooting (55)																											
Display Time	Off	O	O	O	O	O	-	O	O	O	O	O	O	O	O	O	O	O	O	O	O	O	O	O			
	Quick	O	O	O	O	O	-	O	O	O	O	O	O	O	O	O	O	O	O	O	O	O	O	O			
	2 sec./4 sec./8 sec./Hold	O	O	O	O	O	O	O	O	O	O	O	O	O	O	O	O	O	O	O	O	O	O	O			
Display Info	Off	O	O	O	O	O	O	O	O	O	O	O	O	O	O	O	O	O	O	O	O	O	O	O			
	Detailed	O	O	O	O	O	-	O	O	O	O	O	O	O	O	O	O	O	O	O	O	O	O	O			
Grid Lines (52)																											
On/Off		O	O	O	O	O	O	O	O	O	O	O	O	O	O	O	O	O	O	O	O	O	O	O			
Reverse Display (28)																											
On		O	O	O	O	O	O	O	O	O	O	O	O	O	O	O	O	O	O	O	O	O	O	O			
Off		O	O	O	O	O	O	-	O	O	O	O	O	O	O	O	O	O	O	O	O	O	O	O			
IS Settings (83)																											
IS Mode	Off	O	O	O	O	O	O	O	O	O	O	O	O	O	-	O	O	O	O	O	O	O	O	O			
	Continuous	O	O	O	O	O	O	O	O	O	O	O	O	O	O	O	O	O	O	O	O	O	O	O			
	Shoot Only	O	O	O	O	-	-	-	O	O	O	O	O	O	-	O	O	O	O	O	O	O	O	-			
Dynamic IS	Low	O	O	O	O	O	O	O	O	O	O	O	O	-	O	O	O	O	O	O	O	O	O	O			
	Standard	O	O	O	O	O	-	O	O	O	O	O	O	O	O	O	O	O	O	-	O	O	O	-			
	High	-	-	-	-	-	-	-	-	-	-	-	-	-	-	-	-	-	-	-	-	-	O	-			

O Available or set automatically. - Not available.

- Before Use
- Basic Guide
- Advanced Guide
 - Camera Basics
 - Auto Mode / Hybrid Auto Mode
 - Other Shooting Modes
 - P Mode
 - Tv, Av, and M Mode
 - Playback Mode
 - Wireless Features
 - Setting Menu
 - Accessories
 - Appendix
- Index

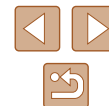

		Shooting Mode																								
		M	Av	Tv	P		AUTO																			
Function																										
Auto level (52)																										
Enable		O	O	O	O	O	O	-	O	O	O	O	O	O	O	O	O	O	O	O	O	O	O	O	O	O
Disable		O	O	O	O	O	O	O	O	O	O	O	O	O	O	O	O	O	O	O	O	O	O	O	O	O
Display Area (40)																										
Large/Medium/Small		O	O	O	O	O	O	O	O	O	O	O	O	O	O	O	O	O	O	O	O	O	O	O	O	O
Auto Settings (40, 42)																										
Seek Assist	On	-	O	O	O	O	O	O	O	O	O	O	O	O	O	O	O	O	O	O	O	-	O	-	O	-
	Off	O	O	O	O	O	O	O	O	O	O	O	O	O	O	O	O	O	O	O	O	O	O	O	O	O
Auto Zoom	Face/Upper Body/Whole	-	O	O	O	O	O	O	O	O	O	O	O	O	O	O	O	O	O	O	O	-	O	-	O	-
	Body/Manual/Auto																									
	Off	O	O	O	O	O	O	O	O	O	O	O	O	O	O	O	O	O	O	O	O	O	O	O	O	O
Date Stamp (42)																										
Off		O	O	O	O	O	O	O	O	O	O	O	O	O	O	O	O	O	O	O	O	O	O	O	O	O
Date / Date & Time		O	O	O	O	O	O	-	-	O	O	-	O	O	O	-	-	-	-	-	-	-	-	-	-	-
Digest Type (35)																										
Include Stills/No Stills		-	-	-	-	O	-	-	-	-	-	-	-	-	-	-	-	-	-	-	-	-	-	-	-	
Face ID Settings (46)																										
Face ID	On	O	O	O	O	O	O	-	O	O	O	O	O	O	O	O	O	O	O	O	O	O	O	O	O	O
	Off	O	O	O	O	O	O	O	O	O	O	O	O	O	O	O	O	O	O	O	O	O	O	O	O	O

- When using Face ID (45) in some modes or with some settings, names of people may be recorded in shots even when not displayed.

O Available or set automatically. - Not available.

- Before Use
- Basic Guide
- Advanced Guide
 - Camera Basics
 - Auto Mode / Hybrid Auto Mode
 - Other Shooting Modes
 - P Mode
 - Tv, Av, and M Mode
 - Playback Mode
 - Wireless Features
 - Setting Menu
 - Accessories
 - Appendix
- Index

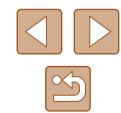

Set Up Tab

Item	Reference Page
Mute	143
Volume	143
Hints & Tips	144
Date/Time	144
Time Zone	144
Lens Retraction	145
Eco Mode	145
Power Saving	26, 145
Disp. Brightness	145
Start-up Image	146
Format	146
File Numbering	147
Create Folder	148
Units	148
Video System	152
Wi-Fi connect'n	112
Wireless settings	112
GPS settings	136
Certification Logo Display	148
Language	148
Reset camera	149

Playback Tab

Item	Reference Page
Play Creative Shot Movies	89
Short Clip Mix	111
Album Playback	108
List/Play Digest Movies	90
Slideshow	94
Erase	98
Protect	96
Rotate	100
Favorites	101
Photobook Set-up	163
i-Contrast	104
Red-Eye Correction	104
Cropping	102
Resize	102
My Colors	103
Face ID Info	90
Transition Effect	87
Index Effect	91
Scroll Display	87
Group Images	92
Auto Rotate	100
Resume	87

Before Use

Basic Guide

Advanced Guide

Camera Basics

Auto Mode /
Hybrid Auto Mode

Other Shooting Modes

P Mode

Tv, Av, and M Mode

Playback Mode

Wireless Features

Setting Menu

Accessories

Appendix

Index



Print Tab

Item	Reference Page
Print	–
Select Images & Qty.	161
Select Range	162
Select All Images	162
Clear All Selections	162
Print Settings	161

Playback Mode FUNC. Menu

Item	Reference Page
Rotate	100
Protect	96
Favorites	101
Print	157
Group Playback	92
Play Movie	87
Play Linked Digest Movie	90
Smart Shuffle	95
Image Search	91
Slideshow	94

Handling Precautions

- The camera is a high-precision electronic device. Avoid dropping it or subjecting it to strong impact.
- Never bring the camera near magnets, motors, or other devices that generate strong electromagnetic fields, which may cause malfunction or erase image data.
- If water droplets or dirt adheres to the camera or screen, wipe with a dry soft cloth, such as an eyeglass cloth. Do not rub hard or apply force.
- Never use cleaners containing organic solvents to clean the camera or screen.
- Use a blower brush to remove dust from the lens. If cleaning is difficult, contact a Canon Customer Support Help Desk.
- To prevent condensation from forming on the camera after sudden temperature changes (when the camera is transferred from cold to warm environments), put the camera in an airtight, resealable plastic bag and let it gradually adjust to the temperature before removing it from the bag.
- If condensation does form on the camera, stop using it immediately. Continuing to use the camera in this state may damage it. Remove the battery pack and memory card, and wait until the moisture has evaporated before resuming use.
- Store unused battery packs in a plastic bag or other container. To maintain battery performance if you will not use the battery pack for some time, about once a year charge it and then use the camera until it runs out of power before storing the battery pack.

Before Use

Basic Guide

Advanced Guide

Camera Basics

Auto Mode /
Hybrid Auto Mode

Other Shooting Modes

P Mode

Tv, Av, and M Mode

Playback Mode

Wireless Features

Setting Menu

Accessories

Appendix

Index



Specifications





Image Sensor

Image size 1/2.3 type
 Camera Effective Pixels
 (Image processing may cause a
 decrease in the number of pixels.).... Approx. 20.3 megapixels
 Total Pixels..... Approx. 21.1 megapixels

Lens

Focal Length
 (35mm film equivalent) 4.3 – 172.0 mm
 (24 – 960 mm)
 Zoom Magnification 40x

Shooting Range (measured from the tip of the lens)

Shooting Mode	Focus Range	Maximum Wide Angle ()	Maximum Telephoto ()
AUTO*	–	1.0 cm (0.4 in.) – infinity	2 m (6.6 ft.) – infinity
Other than the above		5.0 cm (2.0 in.) – infinity	2 m (6.6 ft.) – infinity
		1.0 – 50.0 cm (0.4 in. – 1.6 ft.)	–

* Manual Focus is the same.

Shutter

Shutter Speed

Auto Mode (automatic settings)

Max. Tv 1 sec.
 Min. Tv 1/3200 sec.

Range in all shooting modes

Max. Tv 15 sec.
 Min. Tv 1/3200 sec.

Available Tv values (sec.)

Shooting mode M mode / Tv mode
 15, 13, 10, 8, 6, 5, 4, 3.2, 2.5, 2,
 1.6, 1.3, 1, 0.8, 0.6, 0.5, 0.4, 0.3,
 1/4, 1/5, 1/6, 1/8, 1/10, 1/13, 1/15,
 1/20, 1/25, 1/30, 1/40, 1/50, 1/60,
 1/80, 1/100, 1/125, 1/160, 1/200,
 1/250, 1/320, 1/400, 1/500, 1/640,
 1/800, 1/1000, 1/1250, 1/1600,
 1/2000, 1/2500, 1/3200

Aperture

F number

Wide angle 3.3 – 8.0
 Telephoto 6.9 – 8.0

Flash

Built-in Flash

Flash Range (Max. wide angle)

closest point Approx. 50.0 cm (1.6 ft.)
 farthest point Approx. 4 m (13.1 ft.)

Flash Range (Telephoto end)

closest point Approx. 2 m (6.6 ft.)
 farthest point Approx. 2 m (6.6 ft.)

- Before Use
- Basic Guide
- Advanced Guide
 - Camera Basics
 - Auto Mode / Hybrid Auto Mode
 - Other Shooting Modes
 - P Mode
 - Tv, Av, and M Mode
 - Playback Mode
 - Wireless Features
 - Setting Menu
 - Accessories
 - Appendix
 - Index



Monitor

Type TFT color liquid crystal
 Screen size 3.0 type
 Effective pixels Approx. 0.92 million dots

Shooting

Digital zoom
 Magnification Approx. 4x
 Maximum with Optical Zoom Approx. 160x
 Focal Length (Telephoto end,
 35mm film equivalent) Approx. 3840 mm equivalent
 ZoomPlus
 (Number of recording pixels L) Approx. 80x

Continuous Shooting

Shooting speed*

Auto/P Normal Continuous

Continuous shooting speed Max approx. 5.9 shots/sec

P Continuous AF

Continuous shooting speed Max approx. 4.6 shots/sec

* Continuous shooting speed may become slower due to the following factors:
 Tv value/Av value/Subject conditions/Brightness/Shooting with flash/
 Zoom positions/ Battery level

Recording

File Format DCF-compliant DPOF compatible
 (Version1.1)

Data Type

Still Image

Recording Format Exif2.3 (DCF2.0)

Image JPEG only

Movie

Recording Format MP4









Video MPEG-4 AVC/H.264

Audio MPEG-4 AAC-LC (stereo)

Recorded Pixels, Number of shots per a memory card

Still Image

Using a 16 GB (UHS-I) memory card (Approx. shots)

L		1766
		2980
M		10798
M1		3546
		5925
M2		9344
		16755
S		53992
		80988

Before Use

Basic Guide

Advanced Guide

Camera Basics

Auto Mode /
Hybrid Auto Mode

Other Shooting Modes

P Mode

Tv, Av, and M Mode

Playback Mode

Wireless Features

Setting Menu

Accessories

Appendix

Index



Movie

Size	Recording file size (Approx.)	Single Clip Recording Time (Approx.)	Recording time per a memory card (Approx.)
(1920 x 1080)	4288 KB/sec	29 min. 59 sec.	59 min. 30 sec.
(1920 x 1080)	2945 KB/sec	29 min. 59 sec.	1 hr. 26 min. 5 sec.
(1280 x 720)	992 KB/sec	29 min. 59 sec.	4 hr. 5 min. 15 sec.
(640 x 480)	382 KB/sec	59 min. 59 sec.	10 hr. 22 min. 35 sec.

- Continuous shooting is possible until the memory card becomes full or the recording length for one movie reaches approx. 29 minutes 59 seconds.

Power

Battery PackNB-13L

Number of still image shots (CIPA compliant: room temperature 23 °C / 73 °F)	Approx. 250 shots
Number of still image shots (Eco Mode On)	Approx. 355 shots
Movie recording time (CIPA compliant: room temperature 23 °C / 73 °F)	Approx. 50 min.
Movie recording time (Continuous Shooting)	Approx. 85 min.
Playback Time*	Approx. 5 hr.

* Time when playing back a slideshow of still images

Interface

Wired

Digital terminal
(Hi-Speed USB compliant).....Micro USB
HDMI OUT terminal Type D

Wireless

NFC NFC Forum Type 3/4 Tag compliant (Dynamic)

Bluetooth

Compliance standards..... Bluetooth Ver. 4.1
(Bluetooth low energy technology)
Transmission method GFSK modulation

Wi-Fi

Compliance standards..... IEEE 802.11b/g/n
Transmission frequency
Frequency..... 2.4 GHz
Channels 1-11ch

Security

Infrastructure mode WPA2-PSK (AES/TKIP),
WPA-PSK (AES/TKIP), WEP
* Wi-Fi Protected Setup compliant

Camera access point mode..... WPA2-PSK (AES)
Ad hoc mode WPA2-PSK (AES)

Operating Environment

Temperature..... Min. 0 °C, Max. 40 °C
(Min. 32 °F, Max. 104 °F)

Dimensions (CIPA compliant)

W 110.1 mm (4.3 in.)
H 63.8 mm (2.5 in.)
D 39.9 mm (1.6 in.)

Before Use

Basic Guide

Advanced Guide

Camera Basics

Auto Mode /
Hybrid Auto Mode

Other Shooting Modes

P Mode

Tv, Av, and M Mode

Playback Mode

Wireless Features

Setting Menu

Accessories

Appendix

Index

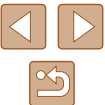

■ Weight (CIPA compliant)

Including Battery Pack,	
Memory Card	Approx. 300 g (approx. 10.6 oz.)
Camera Body Only	Approx. 276 g (approx. 9.7 oz.)

■ Battery Pack NB-13L

Type:	Rechargeable lithium-ion battery
Nominal Voltage:	3.6 V DC
Nominal Capacity:	1250 mAh
Charging Cycles:	Approx. 300 times
Operating Temperatures:	0 – 40 °C (32 – 104 °F)

■ Battery Charger CB-2LH/CB-2LHE

Rated Input:	100 – 240 V AC (50/60 Hz) 0.09 A (100 V) – 0.06 A (240 V)
Rated Output:	4.2 V DC, 0.7 A
Charging Time:	Approx. 2 hr. 10 min. (when using NB-13L)
Operating Temperatures:	5 – 40 °C (41 – 104 °F)

■ Compact Power Adapter CA-DC30/CA-DC30E

Rated Input:	100 – 240 V AC (50/60 Hz) 0.07 A (100 V) – 0.045 A (240 V)
Rated Output:	5.0 V DC, 0.55 A
Charging Time:	Approx. 5 hr.* (when charged with NB-13L in the camera) * Charging time varies considerably depending on the remaining battery level.
Operating Temperatures:	5 – 40 °C (41 – 104 °F)

- The number of shots that can be taken is based on measurement guidelines of the Camera & Imaging Products Association (CIPA).
- Under some shooting conditions, the number of shots and recording time may be less than mentioned above.
- Number of shots/time with a fully charged battery pack.

Before Use
Basic Guide
Advanced Guide
Camera Basics
Auto Mode / Hybrid Auto Mode
Other Shooting Modes
P Mode
Tv, Av, and M Mode
Playback Mode
Wireless Features
Setting Menu
Accessories
Appendix
Index



Index

A

Accessories 151
AE lock 71
AF frames 77
AF lock 80
Aspect ratio 50
AUTO mode (shooting mode) 21, 33
Av (shooting mode) 85

B

Batteries → Date/time (date/time battery)
Battery pack
 Charging 18
 Eco mode 145
 Level 170
 Power saving 26
Black and white imagers 74
Bluetooth 112

C

Camera access point mode 120
Camera Connect 113
CameraWindow 155
CANON IMAGE GATEWAY 126
Center (AF frame mode) 77
Clock 32
Color (white balance) 73
Compression ratio (image quality) 83
Continuous shooting 38, 44
Creative shot 56
Custom white balance 73

D

Date/time
 Changing 20
 Date/time battery 20
 Settings 19
 World clock 144
Defaults → Reset all
Digital tele-converter 77
Digital zoom 39
Display language 21
DPOF 161

E

Eco mode 145
Editing
 i-Contrast 104
 My Colors 103
 Red-eye correction 104
Editing or erasing connection information 139
Erasing 98
Error messages 168
Exposure

 AE lock 71
 Compensation 71
 FE lock 82

F

Face ID 45
Face self-timer (shooting mode) 66
Favorites 101
FE lock 82
File numbering 147

Fireworks (shooting mode) 60
Fish-eye effect (shooting mode) 61
Flash
 Deactivating flash 81
 Flash exposure compensation 82
 On 81
 Slow synchro 81

Focusing

AF frames 77
AF lock 80
MF peaking 76
Servo AF 79

Focus lock 77

Focus range

 Macro 75
 Manual focus 75

Framing assist 40

FUNC. menu

 Basic operations 28
 Table 173

G

Geotagging images 136
GPS information display 89
Grid lines 52

H

Handheld night scene (shooting mode) 59
HDMI cable 152

I

i-Contrast 72, 104
Image quality → Compression ratio (image quality)
Images
 Display period 55
 Erasing 98

Playback → Viewing
 Protecting 96
Image stabilization 83
Image Sync 134
Indicator 31, 54
ISO speed 72

L

Low light (shooting mode) 60

M

M (shooting mode) 85
Macro (focus range) 75
Magnified display 94
Manual focus (focus range) 75
Memory cards 2
 Recording time 182
Menu
 Basic operations 29
 Table 172

Mercury lamp correction 51

Metering method 71

Miniature effect (shooting mode) 62

Monochrome (shooting mode) 64

Movies

 Editing 105
 Recording time 182

Multi-area White Balance 51

My Colors 74, 103

P

P (shooting mode) 70
Package contents 2
Photobook set-up 163
Playback → Viewing
Portrait (shooting mode) 59
Poster effect (shooting mode) 60

Before Use

Basic Guide

Advanced Guide

Camera Basics

Auto Mode /
Hybrid Auto Mode

Other Shooting Modes

P Mode

Tv, Av, and M Mode

Playback Mode

Wireless Features

Setting Menu

Accessories

Appendix

Index



Power 151 → Battery charger,
→ Battery pack
Power saving 26
Printing 157 → Printing
Program AE 70
Protecting 96

R

Recording pixels (image size) 50
Red-eye correction 104
Remote live view shooting 138
Reset all 149
Reset camera 149
Resizing images 102
Rotating 100

S

Saving images to a computer 156
Screen
 Display language 21
 Icons 170, 171
 Menu → FUNC. menu, Menu
SD/SDHC/SDXC memory cards
→ Memory cards
Searching 91
Self portrait (shooting mode) 58
Self-timer 43
 2-second self-timer 44
 Wink self-timer (shooting mode)
 65
Sending images 131
Sending images to another camera
131
Sending images to a smartphone 113
Sending images to Web services 126
Sepia tone images 74
Servo AF 79

Shooting
 Shooting date/time → Date/time
 Shooting information 170
Short clips (movie mode) 69
Slideshow 94
Smart Shuffle 95
Smart Shutter (shooting mode) 64
Smile (shooting mode) 64
Smooth skin (shooting mode) 61
Soft focus (shooting mode) 63
Software
 Installation 120, 156
 Saving images to a computer
 156
Sounds 143
Standard (movie mode) 67
Story Highlights 108
Strap 2, 17
Super vivid (shooting mode) 60

T

Terminal 157
Toy camera effect (shooting mode)
63
Tracking AF 78
Traveling with the camera 144
Troubleshooting 164
TV display 152
Tv (shooting mode) 84

V

Viewing 23
 Image search 91
 Index display 91
 Magnified display 94
 Single-image display 23
 Slideshow 94
 Smart Shuffle 95

TV display 152

W

White balance (color) 73
Wi-Fi functions 112
Wi-Fi menu 117
Wind filter 68
World clock 144
Wrist strap → Strap

Z

Zoom 21, 34, 39

Before Use
Basic Guide
Advanced Guide
Camera Basics
Auto Mode / Hybrid Auto Mode
Other Shooting Modes
P Mode
Tv, Av, and M Mode
Playback Mode
Wireless Features
Setting Menu
Accessories
Appendix
Index



■ Precautions for Wireless Features (Wi-Fi, Bluetooth, or Others)

- Countries and Regions Permitting Wireless Function Use
 - Use of wireless functions is restricted in some countries and regions, and illegal use may be punishable under national or local regulations. To avoid violating wireless regulations, visit the Canon website to check where use is allowed.
Note that Canon cannot be held liable for any problems arising from wireless function use in other countries and regions.
- Doing any of the following may incur legal penalties:
 - Altering or modifying the product
 - Removing the certification labels from the product
- Before goods or technologies in the camera regulated by the Foreign Exchange and Foreign Trade Act are exported (which includes bringing them outside Japan or showing them to non-residents in Japan), export or service transaction permission may be required from the Japanese government.
- Because this product includes American encryption items, it falls under U.S. Export Administration Regulations, and cannot be exported to or brought into a country under U.S. trade embargo.
- Be sure to make notes of the Wi-Fi settings you use.
The wireless settings saved to this product may change or be erased due to incorrect operation of the product, the effects of radio waves or static electricity, or accident or malfunction. Please note that Canon accepts no responsibility for direct or indirect damages or loss of earnings resulting from a degradation or disappearance of content.
- When transferring ownership, disposing of the product, or sending it for repair, restore the default wireless settings by erasing any settings you have entered.
- Canon will not make compensation for damages resulting from loss or theft of the product.
Canon accepts no responsibility for damages or loss resulting from unauthorized access or use of target devices registered on this product due to loss or theft of the product.

- Be sure to use the product as directed in this guide.
Be sure to use the wireless function of this product within the guidelines noted in this guide. Canon accepts no responsibility for damages or loss if the function and product are used in ways other than as described in this guide.
- Do not use the wireless function of this product near medical equipment or other electronic equipment.
Use of the wireless function near medical equipment or other electronic equipment may affect operation of those devices.

■ Radio Wave Interference Precautions

- This product may receive interference from other devices that emit radio waves. To avoid interference, be sure to use this product as far away as possible from such devices, or avoid using the devices at the same time as this product.

■ Security Precautions

Because Wi-Fi uses radio waves to transmit signals, security precautions more stringent than when using a LAN cable are required. Keep the following points in mind when using Wi-Fi.

- Only use networks you are authorized to use.
This product searches for Wi-Fi networks in the vicinity and displays the results on the screen. Networks you are not authorized to use (unknown networks) may also be displayed. However, attempting to connect to or using such networks could be regarded as unauthorized access. Be sure to use only networks you are authorized to use, and do not attempt to connect to other unknown networks.

Before Use

Basic Guide

Advanced Guide

Camera Basics

Auto Mode /
Hybrid Auto Mode

Other Shooting Modes

P Mode

Tv, Av, and M Mode

Playback Mode

Wireless Features

Setting Menu

Accessories

Appendix

Index



If security settings have not been properly set, the following problems may occur.

- **Transmission monitoring**
Third parties with malicious intent may monitor Wi-Fi transmissions and attempt to acquire the data you are sending.
- **Unauthorized network access**
Third parties with malicious intent may gain unauthorized access to the network you are using to steal, modify, or destroy information. Additionally, you could fall victim to other types of unauthorized access such as impersonation (where someone assumes an identity to gain access to unauthorized information) or springboard attacks (where someone gains unauthorized access to your network as a springboard to cover their tracks when infiltrating other systems).

To prevent these types of problems from occurring, be sure to thoroughly secure your Wi-Fi network.

Only use this camera's Wi-Fi function with a proper understanding of Wi-Fi security, and balance risk and convenience when adjusting security settings.

Third-Party Software

- expat.h
Copyright (c) 1998, 1999, 2000 Thai Open Source Software Center Ltd

Permission is hereby granted, free of charge, to any person obtaining a copy of this software and associated documentation files (the "Software"), to deal in the Software without restriction, including without limitation the rights to use, copy, modify, merge, publish, distribute, sublicense, and/or sell copies of the Software, and to permit persons to whom the Software is furnished to do so, subject to the following conditions:

The above copyright notice and this permission notice shall be included in all copies or substantial portions of the Software.

THE SOFTWARE IS PROVIDED "AS IS", WITHOUT WARRANTY OF ANY KIND, EXPRESS OR IMPLIED, INCLUDING BUT NOT LIMITED TO THE WARRANTIES OF MERCHANTABILITY, FITNESS FOR A PARTICULAR PURPOSE AND NONINFRINGEMENT. IN NO EVENT SHALL THE AUTHORS OR COPYRIGHT HOLDERS BE LIABLE FOR ANY CLAIM, DAMAGES OR OTHER LIABILITY, WHETHER IN AN ACTION OF CONTRACT, TORT OR OTHERWISE, ARISING FROM, OUT OF OR IN CONNECTION WITH THE SOFTWARE OR THE USE OR OTHER DEALINGS IN THE SOFTWARE.

Before Use

Basic Guide

Advanced Guide

Camera Basics

Auto Mode /
Hybrid Auto Mode

Other Shooting Modes

P Mode

Tv, Av, and M Mode

Playback Mode

Wireless Features

Setting Menu

Accessories

Appendix

Index

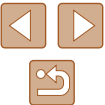

Personal Information and Security Precautions

If personal information and/or Wi-Fi security settings, such as passwords, etc., are saved on the camera, please be aware that such information and settings may still remain in the camera.

When transferring the camera to another person, disposing of it, or sending it for repair, be sure to take the following measures to prevent the leakage of such information and settings.

- Erase registered personal information by choosing [Erase Info] in the Face ID settings.
- Erase registered Wi-Fi security information by choosing [Reset Settings] in the Wi-Fi settings.

Trademarks and Licensing

- Microsoft and Windows are trademarks or registered trademarks of Microsoft Corporation in the United States and/or other countries.
- Macintosh and Mac OS are trademarks of Apple Inc., registered in the U.S. and other countries.
- App Store, iPhone, and iPad are trademarks of Apple Inc.
- The SDXC logo is a trademark of SD-3C, LLC.
- HDMI, the HDMI logo and High-Definition Multimedia Interface are trademarks or registered trademarks of HDMI Licensing, LLC.
- Wi-Fi®, Wi-Fi Alliance®, WPA™, WPA2™ and Wi-Fi Protected Setup™ are trademarks or registered trademarks of the Wi-Fi Alliance.
- The Bluetooth® word mark and logos are registered trademarks owned by Bluetooth SIG, Inc. and any use of such marks by Canon Inc. is under license. Other trademarks and trade names are those of their respective owners.
- The N-Mark is a trademark or registered trademark of NFC Forum, Inc. in the United States and in other countries.
- All other trademarks are the property of their respective owners.
- This device incorporates exFAT technology licensed from Microsoft.

- This product is licensed under AT&T patents for the MPEG-4 standard and may be used for encoding MPEG-4 compliant video and/or decoding MPEG-4 compliant video that was encoded only (1) for a personal and non-commercial purpose or (2) by a video provider licensed under the AT&T patents to provide MPEG-4 compliant video. No license is granted or implied for any other use for MPEG-4 standard.

Disclaimer

- Unauthorized reproduction of this guide is prohibited.
- All measurements based on Canon testing standards.
- Information subject to change without notice, as are product specifications and appearance.
- Illustrations and screenshots in this guide may differ slightly from the actual equipment.
- The above items notwithstanding, Canon cannot be held liable for any loss arising from the use of this product.

Before Use
Basic Guide
Advanced Guide
Camera Basics
Auto Mode / Hybrid Auto Mode
Other Shooting Modes
P Mode
Tv, Av, and M Mode
Playback Mode
Wireless Features
Setting Menu
Accessories
Appendix
Index



Free Manuals Download Website

<http://myh66.com>

<http://usermanuals.us>

<http://www.somanuals.com>

<http://www.4manuals.cc>

<http://www.manual-lib.com>

<http://www.404manual.com>

<http://www.luxmanual.com>

<http://aubethermostatmanual.com>

Golf course search by state

<http://golfingnear.com>

Email search by domain

<http://emailbydomain.com>

Auto manuals search

<http://auto.somanuals.com>

TV manuals search

<http://tv.somanuals.com>