

Network Camera Recording and Monitoring System

***Network Video Recorder
VK-64/VK-16***

Administrator's Manual

Ver. 1.3

Introduction

Thank you for purchasing **Network Video Recorder VK-64 v1.3** (hereafter referred to as “**VK-64**”), a network video recording and monitoring system. **VK-64** is a network video recording and monitoring system and consists of the **Storage Server** and **Viewer**. Please read this manual prior to operation to ensure you will be able to use the Viewer and Storage Server effectively. This manual also explains how to use the Network Video Recorder **VK-16 v1.3** and Viewer-Only use. See P. 18 for the difference between the VK-64 and VK-16. See P. 153 for the functions not available in the Viewer Only mode.

*VK-16 has the same functionality as VK-64 outlined in this manual, unless explicitly indicated otherwise.

Request to Customers

- (1) Canon owns the copyright of this manual. The unauthorized transfer of all or any part of the contents of this Manual is forbidden.
- (2) The content of this manual is subject to change without notice.
- (3) All possible measures have been taken to ensure that the content of this manual is accurate. If you happen to notice errors, omissions or other faults, please contact your vendor.
- (4) Irrespective of items (2) and (3) above, Canon cannot bear responsibility for any effects that result from operation.
- (5) When description of this manual uses the Control Panel, it conforms to operations with Window XP Classic style.

Request to Customers (Indemnity)

Software defect may cause an error in recording and damage or loss of recorded data. Canon cannot bear responsibility for any effects that result from operation. You should agree with it before using the product.

Support Information

For various types of information relating to support, including updated product software (patch installer), User's Manual, operating environment, etc., please refer to our WebView Product web page: canon.com/webview

Copyright Information

Please note that copyright laws prohibit the customer from using recorded videos and still pictures for any purpose other than personal requirements, without permission from the copyright holder.

Trademarks

- Canon and the Canon logo are registered trademarks of Canon Inc.
- Microsoft Windows is a trademark of Microsoft Corporation in the United States and other countries.
- Windows is legally recognized as Microsoft Windows Operating System.
- QuickTime is a trademark of Apple Computer Inc.
- Apache is a trademark of the Apache Software Foundation.
- Pentium is a trademark of Intel Corporation.
- All other company or product names used in this manual are trademarks or registered trademarks of their respective holders.

Icons Used in this Manual



Note

Indicates important information that must be observed or actions that are prohibited during an operation. These notes must be read to prevent possible faults or errors during operation. These notes must be read to prevent possible faults or errors during operation.



Tip

Indicates supplementary information or a reference to an operation. Users are advised to read these memos.

Storage Server includes software developed by the Apache Software Foundation (www.apache.org). Apache software is protected by the copyright law (Copyright(c) 2000-2003 Apache Software Foundation). For the license terms associated with this software, please refer to the file APACHE_LICENSE in the folder LICENSE, within the installation directory.

Purpose of This Manual

This manual is written for the System Administrator deploying the VK-64/VK-16 system.

It explains the functions of VK-64/VK-16 and introduces more appropriate system deployment methods. Use this manual as a reference when making a backup of data or troubleshooting a problem.

Contents

Introduction

Purpose of This Manual	3
About Documents	10
Before Starting Operations with VK-64/VK-16 <Important> ..	11

Chapter 1 System Overview

Chapter Overview	14
Preparation Flow	16
System Operation Overview	18
Communication Mechanism of VK-64/VK-16	20
Typical System Configuration	20
Operating Environment	22
Supported Camera Servers	22
Firmware Upgrade	22
System Environment	23
Viewer	23
Storage Server	23
Notes on Operating Environment	24
Note on Windows XP SP2	24
Note on Windows Server 2003	25
System Design Concept	26
System Configuration	26
About the Master Storage Server	28
When using multiple Storage Servers	28
When using Viewer alone	28
Server Sizing Concept	29
Approximate Video Data Quantity for 1 Second	29
Required Hard Disk Capacity	29
Sensor Event Recording and Motion Detection Recording Concept	32
Storage Server Performance	33
Notes on Viewer Sizing	34
Network Bandwidth Concept	35

Chapter 2 Installation

Chapter Overview	38
Installation Procedures	39
Starting up the installer	39
Upgrading from Version 1.0, 1.1, and 1.2	41
Preparation and Precaution	41

Chapter 3 Storage Server Configuration Reference

Chapter Overview	44
Storage Server Configuration Dialog	45
Start-Up Method	45
Screen Configuration	45

Setting the Settings Tab	50
Displaying Setting Tab	50
How to configure the Settings Tab	50
Message	56
Logon As Service Privilege	57
Disk Space Management <Important>	58
Disk Space Management Level	58
Counteraction at Each Level	58
Low Disk Space Warning Level Calculation Method	60
Threshold Level Calculation Method	60
Limit Level Calculation Method	61
Calculation Example for Each Level	61
Setting the Events Tab	62
How to Display the Events Tab	62
How to Set the Events Tab	63
Setting the Event Notification Tab	64
How to Display the Event Notification Tab	64
How to Set the Event Notification Tab	64
Setting the User Management Tab	66
How to Display the User Management Tab	66
Administrator and Operator Status User	66
How to Set the User Management Tab	67
Changing User to Administrator	67
Delete a User	68
Request User Authentication at Tool Startup	68

Chapter 4 Registering Camera Server and Setting Recording Schedule

Chapter Overview	70
Launching the VK Viewer and Displaying the Configuration and Preferences Screen	71
Launching Procedure	71
Launching by Connecting to the Localhost	72
Specify the IP address of Storage Server to connect Viewer	73
Accessing the Configuration and Preferences screen	75
Storage and Camera Server Summary windows	76
Displaying the Storage and Camera Server Summary Windows	76
Storage Servers and Locations/Zones options	77
Other Functions in Both Tabs	77
Location and Zone	78
Adding a Location or Zone	80
Editing a Location or Zone	81
Deleting a Location or Zone	81
Adding the Storage Server	82
Displaying the Storage and Camera Server Summary Windows	82
Adding the Storage Server	82
Editing the Storage Server	83

Deleting the Storage Server84

Registering Camera Server85

 Storing the Camera Server (by Search)85

 Editing the Camera Server94

 Deleting the Camera Server96

Overview of Setting Recording Schedules98

Recording Schedule99

Configuring a Normal Schedule103

 Creating a Normal Schedule104

Changing the Camera Server Settings113

Batch-Setting Schedules116

Setting Continuous Recording117

Setting Motion Detection Recording118

 Configuring Motion Detection Recording Settings118

 Editing Motion Detection Recording Settings118

Setting Sensor Event Recording125

 Configuring Sensor Event Recording Settings125

 Editing Sensor Event Recording Settings126

Setting the Preset Tour132

 Setting Presets132

Setting a Special Day Schedule136

 About Special Day Recording136

 Adding, Editing and Deleting a Schedule Type137

 Adding and Deleting a Day139

Displaying the Recording Setting Summary142

Chapter 5 Viewer Reference

Chapter Overview146

Viewer Operation Flow148

Starting the Viewer150

 Launching Procedure150

 Connect to the localhost151

 Specify the IP address of Storage Server to connect Viewer152

 Use Viewer only without connecting to Storage Server
 (Viewer Only Mode)153

 Functions not Available during Viewer Only Mode
 (Not Use Storage Server)153

 Viewer Start-up Window154

 Viewer Start-up Option155

Setting the Viewer156

 About the Viewer Settings window156

 Viewer Settings window - Use large captions for Video Windows158

 Viewer Settings window - Identify the Master Storage Server158

 Viewer Settings window - Configure the proxy server158

 Viewer Settings window - Configure layout in the Viewing Screen158

Viewer Settings window - Audio Transmission Settings	159
Viewer Settings window - Configure Focus Settings	159
Viewer Settings window - Edit Event Notifications	160
Saving Viewer Settings	161
Arranging and Saving Layouts	162
Managing Video Layouts	162
About the Layout menu	162
Organizing Layouts and Layout Sequences	164
Saving a Layout or Layout Sequence	166
Arranging Layout Sequences	167
Working with Layout Grids	169
Working with the Alignment Grid	170
Working with the Custom Grid	174
Hiding and Showing Task Areas	175
Basic Video Window Functions	176
Selecting Cameras for Viewing	176
About the Camera Selection Area	176
About Camera Thumbnails	176
Selecting Locations and their Zones	177
Basic Video Window Functions	178
Creating, scaling and moving Video Windows	178
Arranging Video Windows	181
Selecting Multiple Video Windows	181
Video Window States	182
Video Window Properties include:	182
About Video Window states	182
Adjust Pan, Tilt and Zoom	184
Other Video Window Functions	188
Change the size of a Video Window	188
Change the size of a Received Video (VB-C50i/VB-C50iR, VB-C50FSi, VB-C50Fi only)	188
Enabling Backlight Compensation	189
Other Menu Options	190
About Shade Correction	191
About Audio Panel	191
Using the Timeline and Viewing Events	192
Timeline Overview	192
Monitoring Live Video in relation to the Timeline	193
Using the Timeline to examine, play and extract video	194
Initiating a manual recording with duration of one minute	196
Shooting a Snapshot	196
Daylight Savings Indicator	197
Extracting video to save to another location	198
Viewing and Searching Events	199
About Live Events Log list	199
Re-sizing the window to a custom size	199

Displaying the Live Events Log List	200
Overview of Alert Parameters	200
Searching Events	201
Selecting Criteria for Searching	202
Viewing found events	203
Chapter 6 Operation and Management	
Chapter Overview	206
Health Check for Storage Server	207
VK Events (Timeline for VK Viewer)	207
Operation Guideline for Recording and Viewing	208
Live-View Frame Rate Adjustment	208
Recording Frame Rate Adjustment	209
Operation Guideline for Sensor Event Recording	210
Proper Operation of Sensor Event Recording (Optimization of Sensor Arrangement and Sensitivity)	210
Optimization of Motion Detection Recording (Index)	211
Chapter 7 Backup Scheme	
Chapter Overview	214
Purpose of Backup	215
Preparation for Backup	216
About Backup Device	216
About Backup Tool	216
About Restore Server for Archiving	216
Files to Make a Backup	217
Storing Location of Recorded Data and Event data	217
Backup for Data Protection	219
About Backup	219
Backup for Archiving (Long-Term Storage of Data)	220
Backup Procedure for Video Data and Event Data	221
Restore Procedure	222
Restoring Data from Backup for Data Protection	222
Restoring Data from Backup for Data Archiving	223
Examples	225
Configuration 1: Backup for Data Protection 1	225
Configuration 2: Backup for Data Protection 2	225
Configuration 3: Backup for Data Archiving	226
Configuration 4: Backup from Multiple Storage Servers (Backup for Data Protection)	227
Chapter 8 System Maintenance	
Overview of This Chapter	230
Upgrading VK-64/VK-16	231
Reinstalling VK-64/VK-16	232

When You Have the Released Version	232
When You Do Not Have the Released Version 1.3	232
Procedure for Restoring Previous Version	233
Required Media and Data	233
Updating Camera Firmware	234
Procedure for Updating Camera Firmware (VB-C50 series)	234
Chapter 9 Troubleshooting	
Overview of This Chapter	236
Troubleshooting for Recording	237
VK Troubleshooting	238
Viewing Screen and Video Windows	238
Timeline	241
Extracting Video	241
Scheduling and Recording	241
Connection Issues	242
Configuration Issues	243
List of Messages	244
Operation Messages and Error Messages	244
VK-64/VK-16 Recording Engine Logs	258
Access Engine Log	262
VK-64/VK-16 Viewer Logs	262
Log Storage Destination	263
A List of Error Codes in Log File	263
VK Event Information	268
Appendix	
Control of the Camera Server	272
About Hard Disk	273
Lifetime of Hard Disk	273
RAID Reconfiguration	273
Backup of VB Settings	275
Overview	275
Operating Environment	275
Installation	275
Index	277

About Documents

VK-64/VK-16 comes with three manuals including this document.

- **Setting Manual**
Read this manual when setting the Storage Server.
- **Viewer Manual**
Read this manual when using the VK Viewer functions.
- **Administrator's Manual (this document - pdf file)**
This manual is intended for the System Administrator for deploying and operating this software.
Be sure to read this manual to ensure proper system deployment.

Before Starting Operations with VK-64/VK-16 <Important>

It is recommended that you perform tests under actual conditions before starting operations.



Note

- Recording and display of live videos may not be provided as configured because many factors (such as network environment and PC performance) affect the actual performance of VK-64, VK-16.
- When the load on your computer CPU and hard disk is high, the specified frame rate may not be available, or the video recording may be interrupted or the Viewer operation may take longer. Also, when available disk space is low, the disk load may increase and the video recording may be interrupted due to deletion of the recorded video file.
- Using anti-virus and firewall software may affect Storage Server and Viewer operations.
- When using a proxy server (→P. 51, P. 73)
If you use a proxy server, recording frame rate may not be achieved as specified or live video monitoring may be interrupted. Also, communication between the Storage Server and Viewer may occasionally be disconnected.
- If you are using Windows XP SP2 or Windows Server 2003, you need to change Windows settings. Make sure to change the settings. Refer to “Notes on Operating Environment” (→P. 24).
- When recording to a NAS server, it is recommended to separate the communication networks for the camera and NAS.
- Audio function of the VB-C300/VB-C50i/VB-C50iR/VB-C50FSi can also be used.
 - The VK Viewer supports audio transmission and reception.
 - Audio recording is not available.
 - The audio and video may be out of sync.
 - The audio stream may be interrupted according to the performance of your PC and the network environment.
 - The audio feature is not available via a proxy server.
 - If you use a PC on which anti-virus software is installed, the audio stream may be delayed or the audio stream may be temporarily interrupted.

Chapter 1

System Overview

Chapter Overview

This chapter provides preliminary information you should know before using the VK-64/VK-16 and explains the operating environment and basic concept you need to understand to design your system.

● **Preparation Flow**

The following explains the flow from setting up the VK-64/VK-16 to starting the operation.

● **System Operation Overview**

Explains the system operating environment including the number of Camera Servers available for the Storage Server, product types, and the number of licenses for each product.

● **Communication Mechanism of VK-64/VK-16**

Explains the communication mechanism of the VK-64/VK-16, using a typical system configuration.

● **Operating Environment**

Explains the operating environment of the VK-64/VK-16 and points to notice concerning the OS environment.

● **System Design Concept**

Explains the concept and points to notice when designing the system.

Preparation Flow

The following explains the flow from setting up the VK-64/VK-16 to starting the operation.

1 Set up the Camera Servers

The first step is to set up your Camera Servers. Refer to your Camera Server manuals for connection details.

Camera Servers (→ P. 22)



VB-C50FSi



VB-C50i



VB-C300



VC-C50i

VB150

2 Install the Storage Server and Viewer

The Storage Server and Viewer can be installed on one PC. Alternatively, the Viewer can be installed on other computers on the network that will access recorded video from the Storage Server.

Configure the Storage Server via the **Storage Server Configuration** utility to set server settings, event notification and configure user privileges.

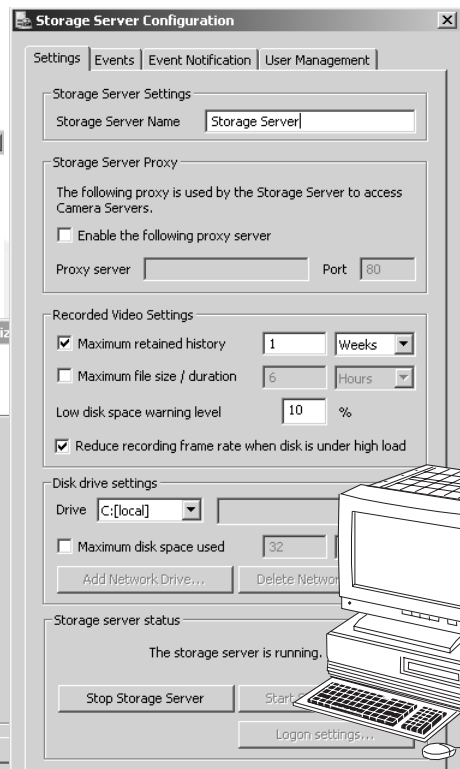
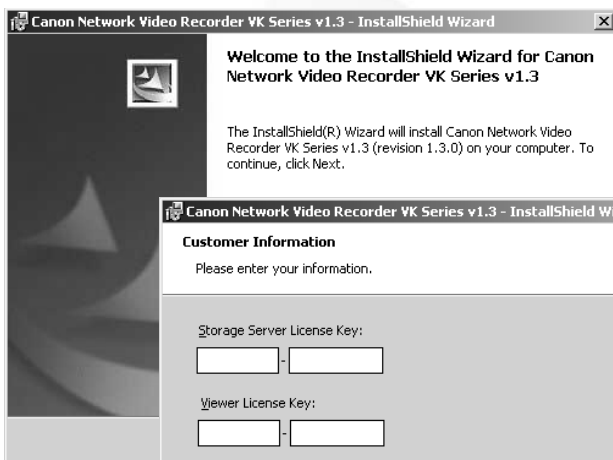

4 Create and save Viewer Layouts

Monitor live video and play back recorded events in the **Viewer** application. From the Viewer you can customize the Viewing Area and save Layouts.

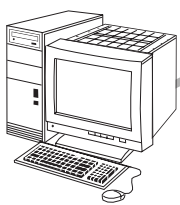

Recorded video from Storage Server



Live video from Camera Servers



3 Configure Recording Settings

Register Camera Servers and Storage Servers and set up recording schedules.

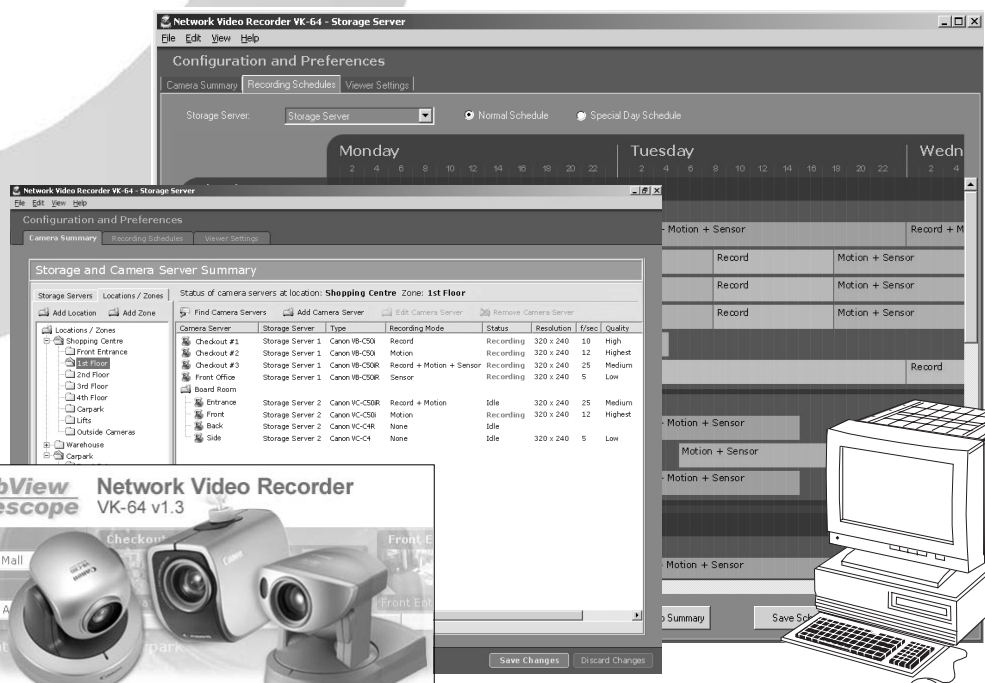

System Operation Overview

VK-64/VK-16 is a software to view and record video images distributed from the VB150/VB101 or a network camera VB-C300/VB-C300/VB-C50FSi/VB-C50Fi/VB-C10/VB-C10R (hereafter referred to as “**camera server**”). VK-64/VK-16 supports up to 64 camera servers via an IP network (e.g., LAN). Although VK-16 has the same basic functionalities as VK-64, it can support up to 16 camera servers.

	Storage Server	Viewer
VK-64	Up to 64 cameras can be registered	Common
VK-16	Up to 16 cameras can be registered Functionality is the same as for VK-64 except for the above camera limitation.	

VK-64 is a software program which consists of the Storage Server and Viewer. The Storage Server can record videos and events (sensor input and motion detection) data from multiple camera servers. The Viewer can display videos from multiple camera servers in real time and play back videos recorded on the Storage Server.

The Viewer can be used by itself without connecting to the Storage Server (Some functions such as video recording, sensor events, and motion detection, Capture Still Frame are not available).

Video resolution can be as high as 640 x 480 pixels, 30 fps for NTSC and 25 fps for PAL (depending on Camera Servers installed).

The following table shows each product and license number:

Product Name	Storage Server	Viewer
Network Video Recorder VK-64 v1.3	1 licenses	1 licenses
Network Video Recorder VK-16 v1.3	1 licenses	1 licenses
Network Video Recorder VK-64 v1.3 Viewer	-	1 licenses
Network Video Recorder VK-64 v1.3 5 Viewers	-	5 licenses

* The Storage Server for VK-16 can register up to 16 camera servers. VK-16 and VK-64 uses the same Viewers.

* Licenses to the VK-64 v1.2/VK-16 v1.2 can be used for v1.3.





Communication Mechanism of VK-64/VK-16

The following explains the communication mechanism of the VK-64/VK-16, using a typical system configuration.

Typical System Configuration

VK-64/VK-16 provides video viewing and recording from Camera Servers via an IP network such as a LAN. Since VK-64/VK-16 makes use of IP networks, installations of cameras can be performed easily. In addition, it is possible to flexibly install new cameras and change installation locations of cameras.

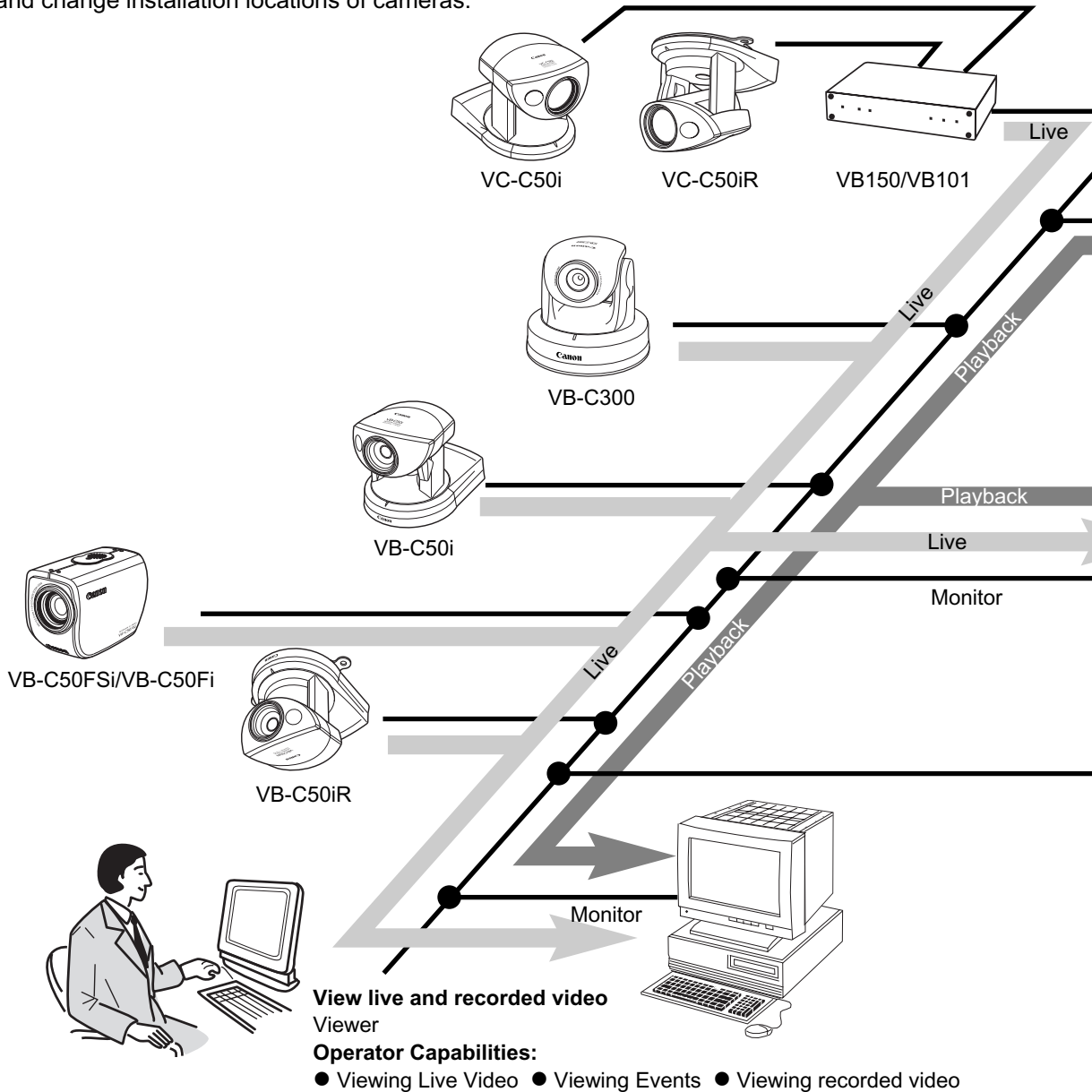

Application Types and Functions

Application	Function
Storage Server	Stores recorded information for later retrieval.
Viewer	Lets users view recorded information, monitor live video and acknowledge/search events. Lets Administrators configure recording and viewing settings.

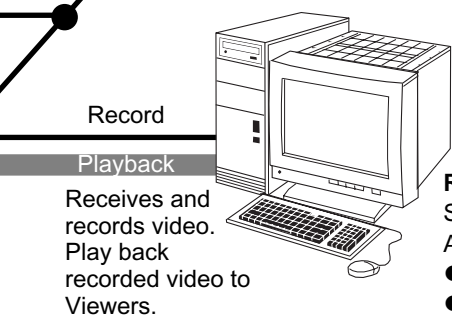
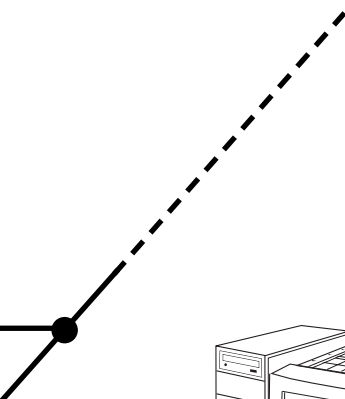

Record video to the Storage Server #1

Storage Server

Administrator Capabilities:

- Configuring Storage Server
- Configuring Event Notification
- Configuring Users

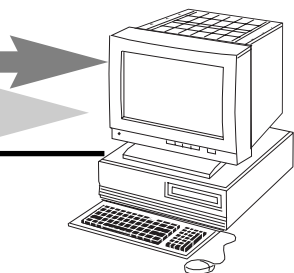

View live and recorded video

Viewer

Administrator Capabilities:

- Configure recording settings
- Configure event alerts
- Viewing Live Video
- Viewing Events
- Viewing recorded video
- Configuring Camera Servers
- Configuring Storage Server

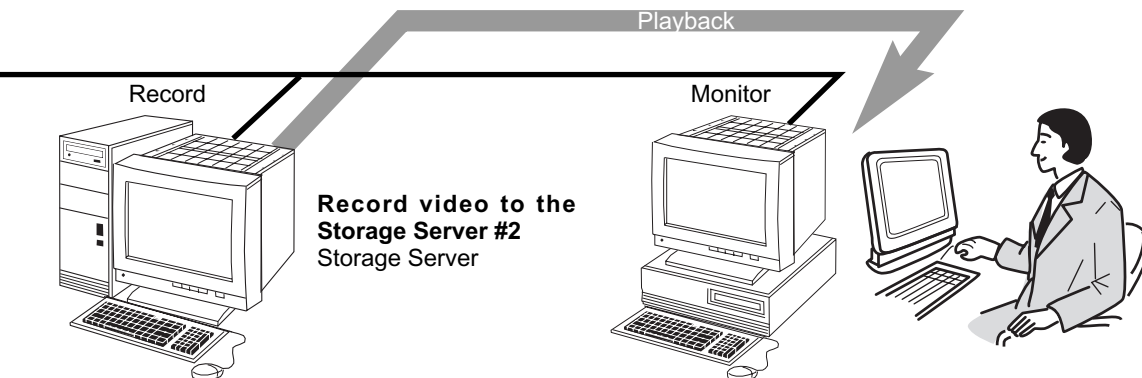







Operating Environment

Supported Camera Servers

The table below lists the Camera Servers that are supported by VK-64/VK-16.

This information is correct as of January 2007. For the latest information, please refer to our WebView Product web page: canon.com/webview

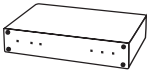
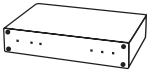
Camera Server	Firmware Versions
VB-C300 	Ver. 1.0
VB-C50i  VB-C50iR 	Ver. 1.1 Rev. 33 or later Ver. 1.2 Rev. 76 or later
VB-C50FSi 	Ver. 1.0 Rev. 68 or later
VB-C50FSi 	Ver. 1.0 Rev. 68 or later
VB-C10  VB-C10R 	Ver. 1.0 Rev. 26 or later
VB150 	Ver. 1.1 Rev. 39 or later
VB101 	Ver. 3.0 Rev. 69 or later



Note

- If using a VB101, you can make use of a single camera connected with VK-64/VK-16 at a time.
- If using a VB150 with multiple cameras, there are restrictions on frame rate.
- If using the Simultaneous mode with the VB150, upgrade the firmware to Version 1.1 Rev.39 or later.

Firmware Upgrade

The latest information concerning firmware can be found on the following Canon Web site: canon.com/webview

System Environment

This information is correct as of January 2007. For the latest information, please refer to our **WebView Product web page: canon.com/webview**

Viewer

	Minimum
CPU	Pentium 4 2.2GHz or greater
Operating System	Windows 2000 Server (with SP4) Windows 2000 Professional (with SP4) Windows XP Professional (with SP2) Windows Server 2003 Standard Edition (with SP1) Windows Server 2003 R2 Standard Edition
Memory	1GB or wider
Hard Disk	2GB or wider
Display	1024 x 768 or higher resolution Color display of 16 bits or more A high performance video card is desirable. With PCI video cards, display performance may be reduced.
Sound	Audio playback support is necessary for event notification alert sounds (→ P. 160).

If using Windows XP Professional SP2 or Windows Server 2003, follow the procedures as described in "Note on Operating Environment" for changing your Windows settings (→ P. 24).

Storage Server

	Minimum
CPU	Pentium 4 2.2GHz or greater
Operating System	Windows 2000 Server (with SP4) Windows 2000 Professional (with SP4) Windows XP Professional (with SP2) Windows Server 2003 Standard Edition (with SP1) Windows Server 2003 R2 Standard Edition
Memory	1GB RAM or greater For more than 48 Camera Servers, 1.5GB or greater required.
Hard Disk	20GB HDD or greater, SCSI or IDE, NTFS formatted

The requirements for Storage Server will vary according to the environment you will use (number of Camera Servers, setting of recording frame rate etc.). It is also dependent on pre-event recording settings. Please contact dealers that handle Canon products for further information. If using Windows XP Professional SP2 or Windows Server 2003, follow the procedures as described in "Notes on Operating Environment" (→ P. 24).

Notes on Operating Environment

Note on Windows XP SP2

If your Storage Server is not installed on the same PC as your Viewer, you will need to change your **Windows firewall** settings for the Storage Server on the PC with Windows XP SP2.

* The following setting is not required if you are installing the Storage Server and Viewer on one PC.

After installation of the Storage Server:

1. From the Windows **Start** menu, launch the **Control Panel**.
2. In **Control Panel**, select **Windows Firewall**. If **Windows Firewall** is not shown, select **Security Center** and then select **Windows Firewall**.
3. In the **Windows Firewall** dialog, select the **Exception** tab and then click **Add Port...**
4. In the **Add a Port** dialog, enter a name for the Storage Server, e.g., "VK-64/VK-16 Storage Server". Enter the Port number as "80". Make sure the TCP protocol is selected and click **OK**.
5. In the **Windows Firewall** dialog, your Storage Server is now listed. Make sure it is enabled (checked). Click **OK** to close the dialog.

Settings are now complete.

If more than ten Camera Servers out of all registered ones cannot be connected to Storage Servers, recording operations may take longer.

Note on Windows Server 2003

The default security level of Windows Server 2003 Standard Edition (SP1) and Windows Server 2003 R2 Standard Edition for the Internet or intranet sites in Internet Explorer is “High”.

As a result, windows such as the settings window do not function normally unless you first register the site in the contents block dialog box that appears when you access the camera’s top page. Register the site to ensure normal functioning.

1. When you access the Camera Server top page etc. in Internet Explorer, the dialog box shown at right appears.

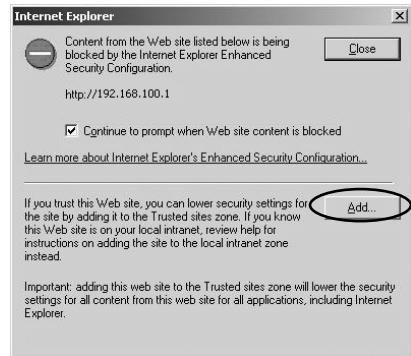

2. Click **Add**. The dialog box for adding Trusted sites then appears.

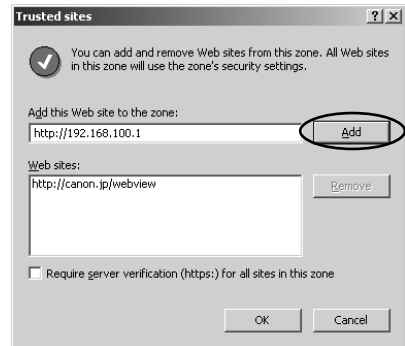

3. Check the IP address of your camera server displayed in the **Add this Web site to the zone** box and then click **Add** to register the camera as a trusted site.

For more information on registering trusted sites, click **Learn more about Internet Explorer’s Enhanced Security Configuration...** in the dialog box in step 1 and refer to the summary provided.

Settings are now complete.

System Design Concept

System Configuration

When Viewing and Recording with one PC

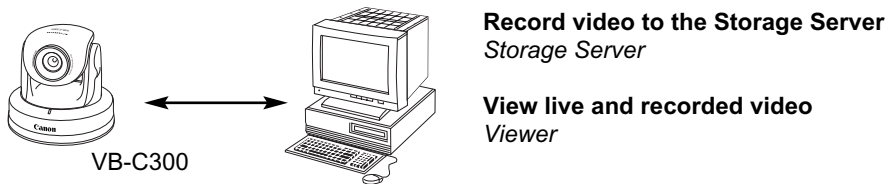

Load on PC may increase depending on the number of camera servers and recording schedule. Consider your system configuration according to “Server Sizing Concept” (→ P. 29).

When Viewing and Recording with one Storage Server and Multiple Viewers

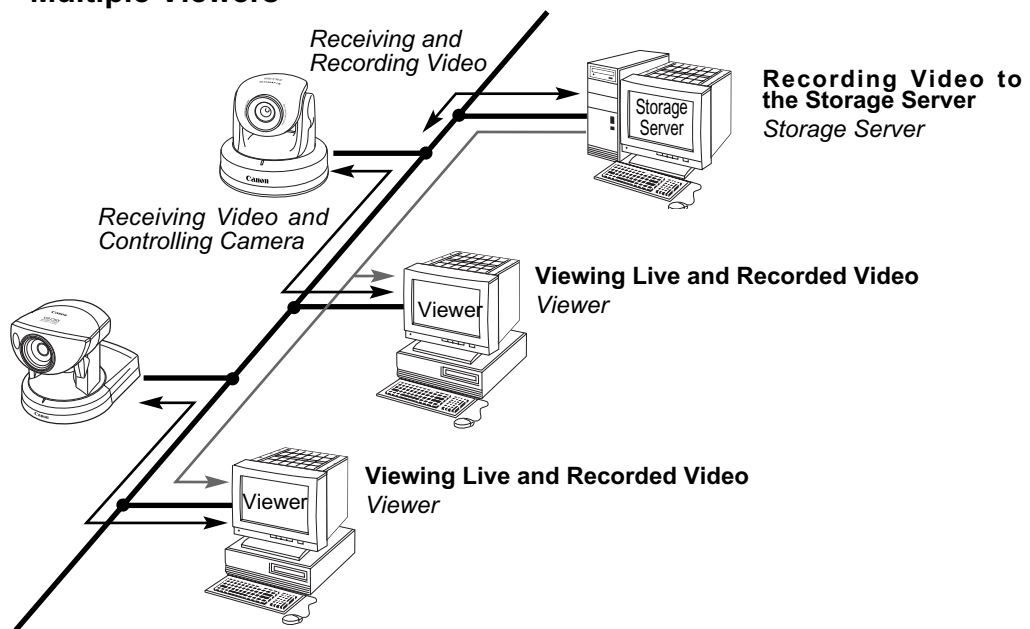

Note

- Having many Viewers accessing the same Camera Servers and Storage Servers will affect system performance.
- Installation of both Storage Server and Viewer on a single PC may cause a heavy load on your PC depending on the number of camera servers or recording schedule. If you use VK-64/VK-16 with many Camera Servers, install each application on separate PCs. Viewing with a low capacity PC may take longer, the specified frame rate may not be achieved, recording frame rate may be lower, or recording may be interrupted.

When using multiple Storage Servers and Viewers

One or more Storage Servers can be used on a network and Viewer applications can be configured to play video from more than one Storage Server. For each Viewer, a Master Storage Server (→ P. 28) needs to be defined for saving information such as zones and locations of cameras, as well as saving Viewer layouts created by the user.

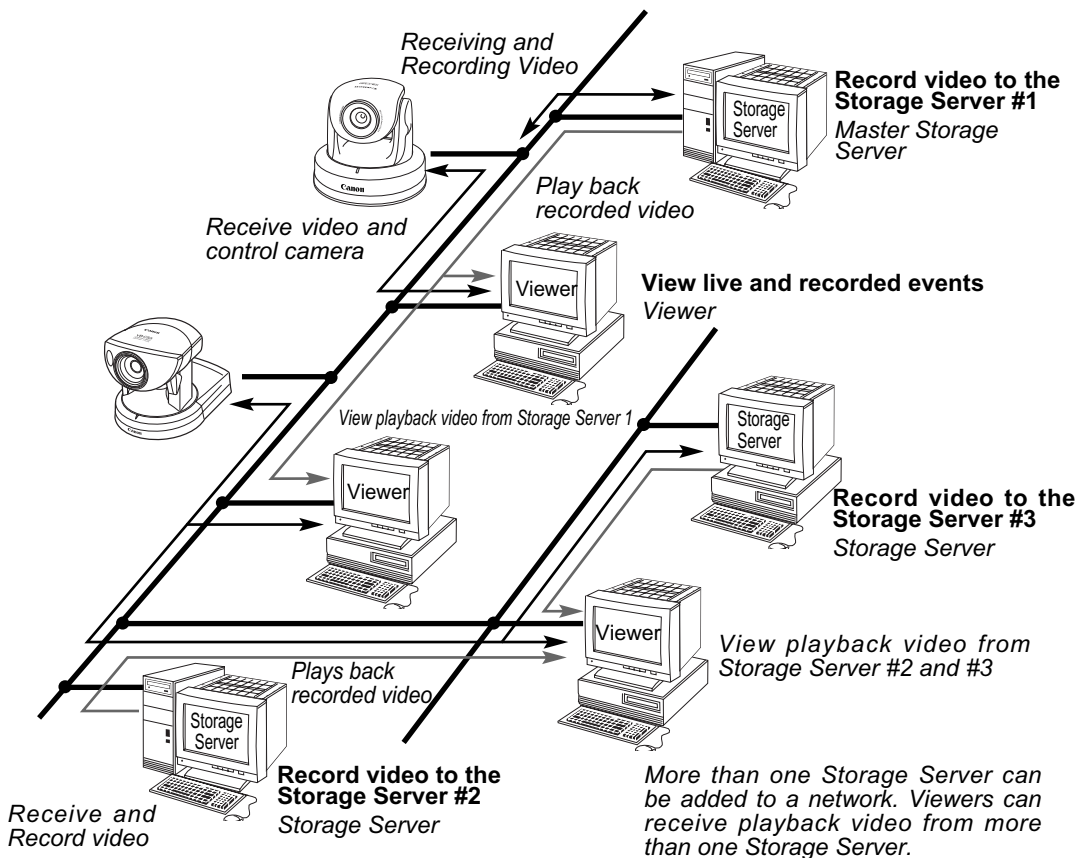

Note

- You can operate VK-64/VK-16 with up to ten Storage Servers using any combination of VK-64 Storage Server and VK-16 Storage Server. Up to 192 Camera Servers can be operated.
- Up to ten Viewers can connect to the Storage Servers at the same time.
- If the Storage Server and/or Viewer are installed on multiple PCs, you'll need to purchase the necessary licenses separately (→P. 18).

About the Master Storage Server

A Master Storage Server is the Storage Server which a Viewer will connect to in the first place. Information about Camera Servers, Locations and Zones and Viewer Layouts are stored on the Master Storage Server. The Viewer extracts the information from the Master Storage Server.



Note

- It is recommended that all Viewers within a system use the same Storage Server as a Master Storage Server. This ensures that all Viewers use the same Zones, Locations and Viewer Layouts.
- For correct operation, the time setting of all PCs within a system (including Storage Servers and Viewers) must be correct. We recommend that you use NTP function to set the time for Storage Server automatically.
- Adjusting the time of Storage Server during recording may cause problems to the recording video.

When using multiple Storage Servers

If multiple Storage Servers are being used, you should decide which one is the Master Storage Server. A typical multiple Storage Server arrangement could be.

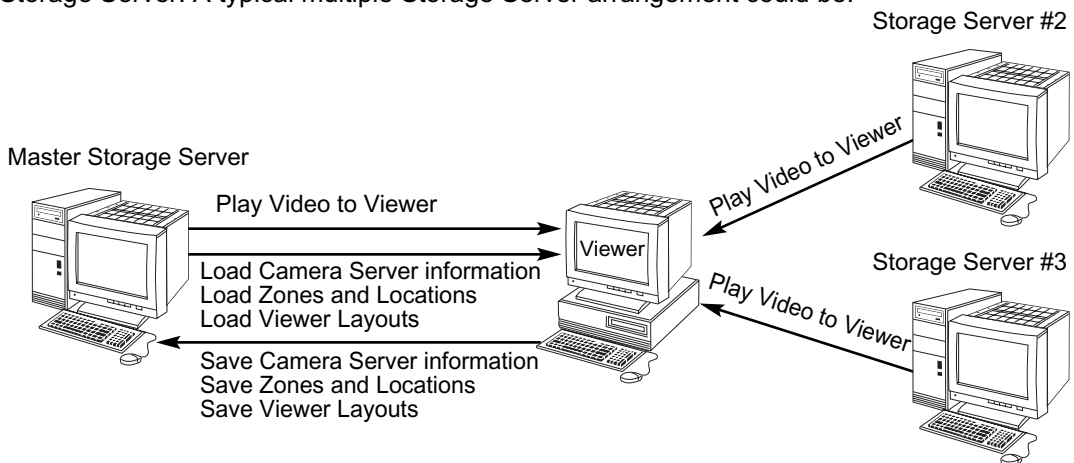

Note

When multiple Storage Servers are operated, if the Storage Servers other than the Master Storage Server are stopped, it takes time to display the Configuration and Preferences screen (approximately up to 30 seconds).

When using Viewer alone

The Viewer can be used by itself without connecting to the Storage Server. Although there are some restrictions on functions such as recording and Event Search, Viewer-Only mode allows to view live videos (→ P. 151).

Server Sizing Concept

Determine your server configuration (components and the number of units) depending on 1) required hard disk capacity and 2) video data quantity per second.

- 1) Required hard disk capacity: Consider the required hard disk capacity depending with regard to continuous recording with fixed frame rate, resolution, and quantity. For reference, you should use multiple servers if the required hard disk capacity is 1.5 TB to 2 TB per server.
- 2) Video data quantity per second: If the video data quantity per second per server exceeds values shown below, you should use multiple servers or review the recording conditions.



Note

Every installation of VK-64/VK-16 is different (due to different usage requirements and different hardware specifications) and the figures provided in this section are an indication only.

Approximate Video Data Quantity for 1 Second

The recording performance of the VK-64/VK-16 v1.3 is as follows.

- For dedicated Storage Server: Maximum amount of recorded data per server = 5.5 MB/sec or less
(VGA: 110 fps, QVGA: 360 fps)
- For Storage and Playback Server: Maximum amount of recorded data per server = 3 MB/sec or less
(VGA: 60 fps, QVGA: 200 fps)



Note

The write performance may be lower than mentioned above depending on the RAID card used.

Required Hard Disk Capacity

The VK-64/VK-16 receives each image from a Camera Server as a JPEG image. The size of the images varies depending on the configuration of the Camera Server (the settings for Quality and Resolution) and the complexity of the actual image.

Determining Hard Disk Capacity

Determine the hard disk capacity as follows.

- 1 Determine the required number of Camera Servers and video resolution.
- 2 Determine the quality of each Camera Server.
Higher quality causes larger data per frame.
- 3 Determine the frame rate for recording video (i.e., the number of frames per second).
For general security purposes, 1 to 2 fps is common. Higher frame rate requires more hard disk space.
- 4 Determine the recording period per day and duration to retain data.
- 5 After determining the conditions above, calculate the required hard disk capacity according to the video data size per screen (in KB). Refer to “Example of Frame Sizes with VB-C300” and “Example of Frame Sizes with VB-C50i” (→ P. 31).

Example:

- Recording continuously at 2 fps,
- Using 16 Camera Servers (VB-C50i) for recording,
- With each camera set to Medium Size for video capture and Quality set to 50, and
- Frame size* per single frame is approximately 15 KB.
Although actual data size depends on objects shot by each Camera Server, this calculation assumes the typical size shown above.

For the above configuration, if the 16 Camera Servers are being recorded continuously at 2 frames per second all day, every day, the disk requirements would be approximately 40GB per day (15KB x 2fps x 16 cameras x 60 seconds x 60 minutes x 24 hours = 41472000KB per day).

However, when determining hard disk sizes it is important to take into account that there needs to be some room (10 to 20%).

* For the above figures please note that the bandwidth is calculated as 1000Kbps = 1Mbps, and the disk size as 1024KB = 1MB.

The following tables give some typical frame sizes (in kilobytes) for various quality and resolution values from a VB-C300 and VB-C50i. However it is important to note that, depending on the complexity of the image, the frame sizes may vary substantially from those listed in the tables. For example, images of an empty corridor would typically be smaller than these values and images of a very intricate pattern such as a crowded shopping mall would typically be larger than these.

Example of frame sizes with VB-C300*

Quality	Resolution		
	Small (160x120)	Medium (320x240)	High (640x480)
1	4.0	12.5	36.0
2	4.6	14.8	42.4
3	5.2	16.8	47.5
4	6.8	22.3	62.9
5	18.9	65.5	206.0

(values are in KB)

Example of frame sizes with VB-C50i*

This is true for the VB-C50i and VB-C50FSi.

Quality	Resolution		
	Small (160x120)	Medium (320x240)	High (640x480)
30	3.8	11.1	36.4
40	4.4	13.3	43.4
50	5.0	15.1	49.2
70	6.6	20.3	67.0
80	8.1	25.4	85.5
90	11.8	37.3	128.0

(values are in KB)

* The data size mentioned above is an indication only, which will vary in accordance with the subject being captured. Please be sure to confirm under the actual installation conditions before starting operations. Select **Video Information** from the **View** menu of the Viewer (supplied with the Camera Server) to check the data quantity per frame.



Note

Please note that data size may increase enormously when video quality is set to 100 with the VB-C50i.

Sensor Event Recording and Motion Detection Recording Concept

● Notes on Sensor Event Recording and Motion Detection Recording

- When an event such as sensor input or motion detection occurs, it will be stored in the Storage Server as an operation record.
- As the number of stored operation records increased, the operation and search speed at event detection may be affected.

● Notes on Motion Detection Recording

- The Motion Detection function detects motion which occurs where no motion is usually occurring.

Do not use this function where the motion detection operates too frequently, e.g., where many people pass.



Tip

Refer to “Operation Guideline for Sensor Event Recording” (→ P. 210) and “Optimization of Motion Detection Recording (Index)” (→ P. 211) for details.

Storage Server Performance

For the latest information on performance, please refer to our
WebView Product web page: canon.com/webview

<Case 1>

Camera Servers: 24 VB-C50i
Resolution: High (640 x 480)
Quality: 50
Frame Rate: 10 fps

[Recording]

Example of Storage Server PC specifications
CPU: Pentium 4 3GHz
Memory: 1GB
HDD: Please refer to “Disk Space Management <Important>” (→ P. 58)
(Sample specifications for 3-day storage: about 1.1 TB for each Storage Server)

Three Storage Servers with the above PC specifications
(one master device, two slave devices)

[Live View, Recorded Video Playback]

Example of Viewer PC specifications
CPU: Pentium 4 3.8GHz
Memory: 1GB
Video graphics board: NVIDIA Quadro FX 1400

<Case 2>

Camera Servers: 48 VB-C50i
Resolution: Medium (320 x 240)
Quality: 50
Frame Rate: 1 fps

[Recording]

Example of Storage Server PC specifications
CPU: Pentium 4 3GHz
Memory: 1GB
HDD: Please refer to “Disk Space Management <Important>” (→ P. 58)
(Sample specifications for 14-day storage: about 900 GB)

One Storage Server with the above PC specifications

[Live View, Recorded Video Playback]

Example of Viewer PC specifications
CPU: Pentium 4 3.0GHz
Memory: 1GB
Video Graphics Board: On-chip board



Note

- **These are samples from a specific configuration. As many factors can influence the actual performance possible (including networking equipment, disk write speed, complexity of camera image, etc), the actual performance of VK-64/VK-16 recording in a specific installation will vary. Please be sure to confirm under the actual installation conditions before starting operations.**
- **If there are many Camera Servers registered, it is recommended that you use two or more PCs or configure to use the Layout Sequences feature.**

Notes on Storage Server Deployment

It is recommended to use the Storage Server exclusively for the VK-64/VK-16.

Be sure to avoid the following forms of deployment.

- Using the Storage Server with a Web Server

You cannot use the Storage Server on a PC where Web server software such as Windows standard IIS (Internet Information Server) or Apache is already installed.

Since the Storage Server uses the HTTP protocol to communicate with the Camera Server, it will not operate if other Web applications exist on the same platform.

The HTTP port number used by the VK-64/VK-16 is fixed to “80”.

- Using the Storage Server with a Database Server (e.g., SQL Server, Oracle)

If the hard disk is heavily loaded (e.g., executing a distributed database application which transfers several-hundred GB of data between databases), recording may be interrupted. Conversely, the database server may be affected by the VK-64/VK-16 when it tries to a demanding task.

- Using the Storage Server with a File Server

Accesses to the hard disk may be too frequent and recording may be interrupted. Also, the disk capacity for the VK-64/VK-16 may run short.

Notes on Viewer Sizing

Consider the following when selecting the PC where the Viewer should be installed.

- Live viewing and recording performance of the VK-64/VK-16 largely depends on the CPU and graphics board performance of the PC. The CPU performance affects image capturing and video data generation, while the graphics board performance affects image drawing.

Use the following example for reference when selecting the PC where the Viewer should be installed.

Use the Windows XP Professional SP2 for the operating system.

- 1) CPU: Pentium4 3.0GHz, memory: 1GB, graphics board: Quadro FX540
When using the VB-C50i with Resolution=340 x 240 and Quality=50:
Total frame rate: Max. 220 fps
- 2) CPU: Pentium4 3.6GHz, memory: 1GB, graphics board: Quadro FX1400
When using the VB-C50i with Resolution=340 x 240 and Quality=50:
Total frame rate: Max. 260 fps
- 3) CPU: Pentium4 3.8GHz, memory: 1GB, graphics board: Quadro FX1400
When using the VB-C50i with Resolution=340 x 240 and Quality=50:
Total frame rate: Max. 280 fps



Tip

- **The total frame rate is calculated as: Number of Camera Servers in the Viewer window x Frame rate. That is, with 10 Camera Servers and 10 fps frame rate, the total frame rate is 100 fps.**
- **Note that the total frame rate varies depending on the combination of the PC and graphics board. It is also affected by other applications (e.g., anti-virus application) running on the same PC.**

Network Bandwidth Concept

You must consider the network bandwidth when recording video or viewing live video from the network camera.

The network bandwidths must be calculated separately for recording and live viewing.

Example:

With one recording server (QVGA, 1 fps) and two live viewing servers (QVGA, 5 fps):

- Bandwidth for recording
 $15 \text{ (KB/frame)} \times 1 \text{ (frame/sec)} \times 8 \text{ (bits)} = 120 \text{ Kbps}$
- Bandwidth for live viewing (per server)
 $15 \text{ (KB/frame)} \times 5 \text{ (frame/sec)} \times 8 \text{ (bits)} = 600 \text{ Kbps}$

Therefore, required network bandwidth is calculated as follows:

$$120 \text{ Kbps} \times 1 + 600 \text{ Kbps} \times 2 = 1320 \text{ Kbps} = \text{Approx. } 1.3 \text{ Mbps}$$

Note that the line speed unit is bps (bits per second).

Chapter 2

Installation

Chapter Overview

This chapter explains how to install VK-64/VK-16.

1 Setting up the Camera Servers

2 Install the Storage Server and Viewer



Note

Before beginning installation, read Chapter 1 and “Preparation and Precautions” (→ P. 41) carefully.

When you install VK-64/VK-16, icons for two applications composing VK-64/VK-16 will be created on the desktop.



Storage
Server
Configuration



VK Viewer



Tip

- Refer to Chapter 3 for how to use the Storage Server.
- Refer to Chapter 4 for how to use the VK Viewer.

Installation Procedures



Note

- Types and number of licenses you can install vary according to the product you have purchased. If additional Storage Server and Viewer installations are required, you will need to purchase the necessary software (→ P. 18).
- The hard disk where the software will be installed must be formatted in the NTFS (→ P. 41).

Starting up the Installer



- 1 Insert the Network Video Recorder installation disc into your CD drive. The **Welcome** screen appears. Click **Next** to continue.

If the installer does not automatically load, open the CD directory in Explorer and browse to locate **Setup.exe**. Double-click to begin installation.

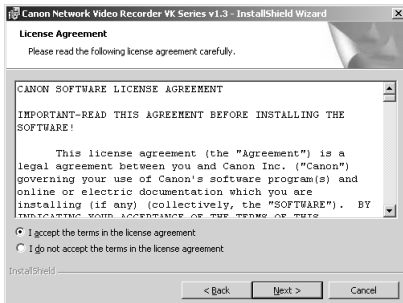

- 2 The **Software License Agreement** screen appears. Read the agreement carefully. Click the radio button, **I accept the terms in the license agreement** and then click **Next** to continue.

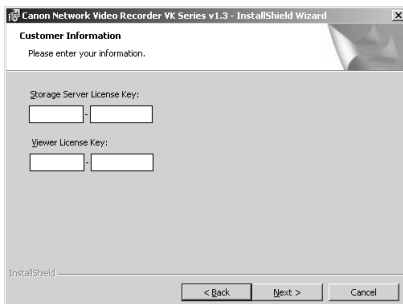

- 3 Enter your License Key(s) and click **Next**. Your License Key is indicated on the “About License Key” included in the package.



Tip

If you are installing the Storage Server alone, enter the License Key for the Storage Server only. If you are installing the Viewer alone, enter the License Key for the Viewer only.

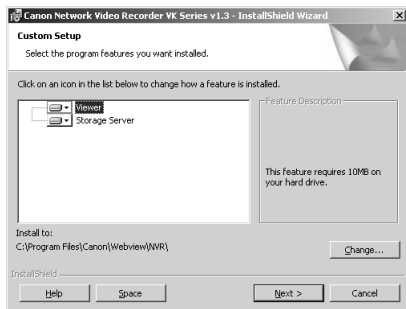

4

Depending on your License Key, you will be presented with one or both of the following applications shown below:

- **Viewer**
- **Storage Server**

It is recommended to keep the install to: path as is. Click **Change...** to choose another installation path if necessary.

Click **Next** to continue. See “Tip” below for the **Help** and **Space** buttons.



Tip

- **Click Help to obtain details on the type of installation. The type is indicated by the icon next to the application to be installed.**
 - **Click Space to view the amount of disk space required in order to install VK-64/VK-16. A list of drives is shown.**
- In either dialog, click OK to return to the installation steps.**

When you click **Next**, installation will proceed and a progress bar will be displayed.

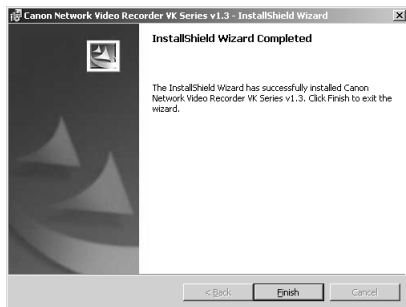

5

When the **InstallShield Wizard Completed** screen displays, click **Finish**.

Installation is now finished.



Note

- **In future, if you need to check your product type, refer to the About box of the Storage Server or Viewer (→ P. 46).**
- **If the Storage Server is installed, it will be automatically started after installation.**

Upgrading from Version 1.0, 1.1, and 1.2

If you upgrade the Viewer from an older version, all the settings are taken over to the new version and video data recorded with older version can be played back with Version 1.3. It is important to verify your settings after installation.

For the details, see “Upgrading VK-64/VK-16” (→ P. 231).



Note

- The Viewer v1.3 can connect to the Storage Server v1.2. However, you cannot use the recording functions added in v1.3 (e.g., preset tour).
- If the Storage Servers v1.2 and v1.3 coexist, either Storage Server can be specified as the Master Storage Server.
- The Viewer v1.3 cannot connect to the Storage Server v1.0 or v1.1.
- The Viewer v1.0, v1.1, or v1.2 cannot connect to the Storage Server v1.3.
- The VB-C300 cannot be registered on an v1.0, v1.1, or v1.2 Storage Server.
- When upgrading from any versions before 1.1.2.27, you need to set motion detection (→ P. 119) again. You can check your version information from the About box (→ P. 46) of the Storage Server and the Viewer.
- The VB-C300 cannot be registered on the Storage Server v1.0, v1.1, or v1.2.

Preparation and Precaution

● Use NTFS-formatted hard disk

The hard disk where the software will be installed and video data will be stored must be formatted in the NTFS.

You can convert the hard disk into the NTFS format using the following command at the command prompt.

“convert (Name of the drive):/fs:ntfs”

Example: To convert Drive C into the NTFS format:
 convert c:/fs:ntfs



Tip

Select All Programs, Accessories, and Command Prompt from the Start menu to display the command prompt. If you press the Enter key following the command shown above, a series of questions appears, then conversion starts. Reboot the PC after the process completes conversion. You will not lose any data on the hard disk by conversion.

 **Stop other applications**

You must stop other applications including anti-virus program before starting installation.

Chapter 3

Storage Server Configuration Reference

Chapter Overview

The Storage Server can record videos and events (sensor input and motion detection) data from multiple camera servers.

This chapter explains how to set the installed Storage Server.

Use the **Storage Server Configuration** dialog to set the Storage Server.

In the **Storage Server Configuration** dialog, you can configure settings for disk management, event management, event notification, and user management.

● **Settings Tab**

In the **Settings** tab, specify the Storage Server name, Proxy Server, and recording options.

● **Event Tab**

You can set the Storage Server to send an e-mail to the user when an event has occurred.

In the **Event** tab, specify the priority for each event type.

● **Event Notification Tab**

In the **Event Notification** tab, configure the settings for sending an e-mail when an event has occurred.

● **User Management Tab**

In the **User Management** tab, add users and assign privileges to them.

Storage Server Configuration Dialog

Start-Up Method



Double-click the **Storage Server Configuration** desktop icon.

Alternatively, from the Windows **Start** menu select: **All Programs > WebView Livescope > Network Video Recorder VK Series v1.3 > Storage Server Configuration**.

If the **Authentication is required when starting this tool** is checked (→ P. 49), the **Login** dialog opens.



Enter your user name and password, and click **Login**.



Note

To configure the Storage Server, you must log into Windows with the Windows Administrator privilege.

Screen Configuration

The **Storage Server Configuration** dialog has the following four tabs.

- **Settings Tab**
- **Events Tab**
- **Event Notification Tab**
- **User Management Tab**

Settings Tab

The **Storage Server Configuration** dialog, **Settings** tab allows you to configure.

- Storage Server Name
- Proxy Server
- Recording options

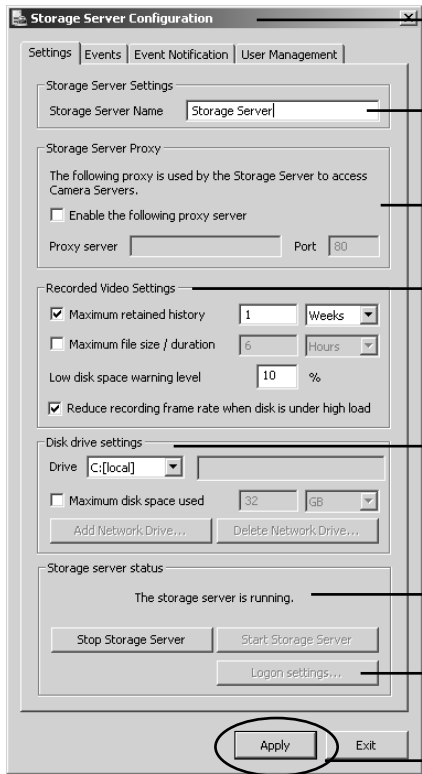

The screenshot shows the 'Storage Server Configuration' dialog box with the 'Settings' tab selected. The dialog is divided into several sections: 'Storage Server Settings', 'Storage Server Proxy', 'Recorded Video Settings', 'Disk drive settings', and 'Storage server status'. The 'Storage Server Name' field contains 'Storage Server'. The 'Storage Server Proxy' section has an unchecked checkbox for 'Enable the following proxy server' and a 'Proxy server' field with 'Port' set to '80'. The 'Recorded Video Settings' section has checkboxes for 'Maximum retained history' (checked, set to 1 Week), 'Maximum file size / duration' (unchecked, set to 6 Hours), 'Low disk space warning level' (set to 10%), and 'Reduce recording frame rate when disk is under high load' (checked). The 'Disk drive settings' section shows 'Drive' set to 'C:[local]' and 'Maximum disk space used' set to 32 GB. The 'Storage server status' section shows 'The storage server is running.' and buttons for 'Stop Storage Server', 'Start Storage Server', and 'Logon settings...'. The 'Apply' button at the bottom is circled.

Click the title bar icon and select **About Storage Server Configuration** or right-click the title bar to display the **About Storage Server Configuration** box.

Enter a name for your Storage Server.

Enter a proxy address for connecting to Camera Servers.

Set Maximum retained history, Maximum file size/duration and Low Disk Space Warning Level.

Set maximum disk space used for each device. Also, add or remove network drives.

Storage Server status indicator. **Start Storage Server** and **Stop Storage Server** start and stop the Storage Server.

Use an account other than the **Local System account** to log onto the Storage Server to enable connection to the network drive (you cannot use the network drive on Windows 2000).

Click **Apply** to save changes when you modify settings from each tab.



Tip

The VK-64/VK-16 can save video data on the network drive. However, you cannot use the network drive on Windows 2000.

Events Tab

You can set the Storage Server to send an e-mail to the user when an event has occurred.

The **Storage Server Configuration** dialog, **Events** tab allows you to configure:

E-mails are sent according to the priorities set in the **Events** tab.

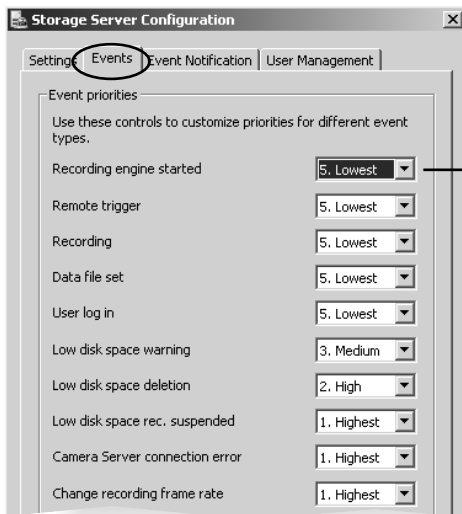

Select a suitable event priority from the drop-down menu for each event type listed.



Tip

- Events associated with “Storage Server started/stopped”, “User log in”, and “Network drive assignment error” do not appear in a Viewer’s Timeline (→ P. 192), Live Events Log (→ P. 199), or Event Search Dialog (→ P. 201).
- The priority of an event created by a manual recording using Record Now (→ P. 196) will always be Priority 1. It cannot be changed from this dialog.

Event Notification Tab

The **Storage Server Configuration** dialog, **Event Notification** tab allows you to configure.

E-mails are sent according to the priorities set in the **Events** tab.

Example event notification e-mail

An event of priority 3 occurred on 12/05/2006 at 15:15:17 +1000.

Parking Lot 1: Sensor on

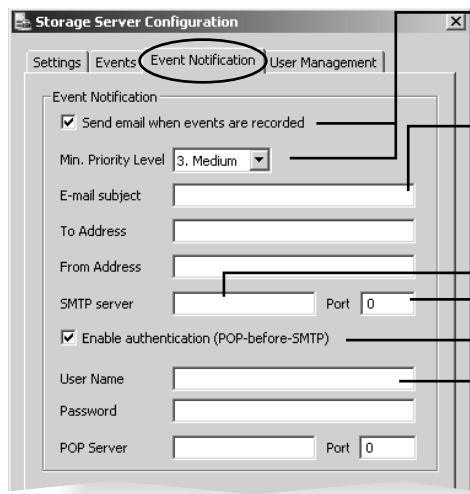

Enable e-mail notification and select a priority. Events of that priority and above will lead to notification e-mails.

Enter the e-mail subject line, for example, "Immediate Action Required". Enter the address of the recipient and enter your from address.

Enter a Host Name or IP address and Port Number of mail server for outgoing mail.

Enable authentication (POP-before-SMTP) for connection and enter **User Name**, **Password** and **POP Server** details. If this is enabled, the Storage Server will attempt to perform a POP login before sending e-mail that may be required for some SMTP servers.



Tip

You can only register one e-mail address in the To Address field. If you want to send the e-mail to multiple addresses, use a group address.

User Management Tab

The **Storage Server Configuration** dialog, **User Management** tab allows you to set up users and their privileges.

User Management tab allows you to configure the following privileges:

- Administrator
- Not Administrator (Operator)

Administrators have access to the Viewer including Camera Server setup, recording schedules and Viewer setup.

Storage Server Configuration

Settings | Events | Event Notification | User Management

Users: Administrator

admin

Agd... Edit Remove

Authentication is required when starting this tool.

Apply Exit

Check to enable user to have Administrator privileges (full access to configuration functions).

Use **Add** to add users to this field. There is no limit to the number of users you can add.

If the **Authentication is required when starting this tool.** box is checked, the Login dialog opens.

Click **Apply** to save changes.

Users who have Operator Status cannot configure, register and change Camera Servers, or configure and change recording schedules.

By default, a user called “admin” is created. The password is “NVR”. It is strongly recommended that this is changed after installation.

It is necessary to set up users on all Storage Servers. A particular user should be set up to have the same password on each Storage Server.

Setting the Settings Tab

The **Storage Server Configuration** dialog, **Settings** tab allows you to configure.

- Storage Server name
- Proxy Server
- Settings for storing recorded video
- Start and stop of Storage Server
- Logon Account for Storage Server

Displaying Settings Tab

Double-click the **Storage Server Configuration** desktop icon.

The **Storage Server Configuration** dialog opens and the **Settings** tab is displayed.

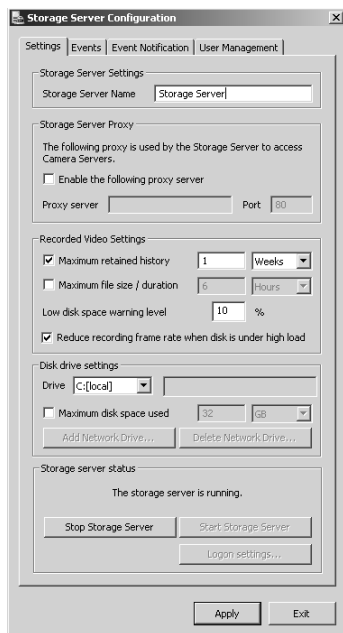

How to configure the Settings Tab

● Changing the Storage Server name



Enter a new name in **Storage Server Name** to change the Storage Server name (You can use up to 20 characters).



Tip

It is recommended to use an easy-to-understand name if you are using multiple Storage Servers.

Enter the Storage Server Proxy Address

If the Storage Server needs to access Camera Servers outside the LAN, you may need to configure proxy settings.

* See “When using a proxy server” (→ P. 11).

- 1 In the **Storage Server Proxy** field, tick the **Enable the following proxy server** box.
- 2 Enter the **Proxy server** address and **Port**.

For more information on proxy server usage, see your Camera Server administrator.

Enter Recorded Video Settings

- 1 **Maximum retained history** - Check the **Maximum retained history** option and enter a value from 1 to 999 and then select **Days** or **Weeks** from the drop-down menu.

- 2 **Maximum file size/duration** - Check the **Maximum file size/duration** option, enter a value (e.g., “100” or “24”), and select **MB** or **Hours**. You can enter 32 - 1024 for **MB** and 1 - 24 for **Hours**. This will establish the maximum size used for each file of recorded video. If you do not enter a value, 1024 MB or 24 hours is used for the Maximum file size/duration value.
- 3 **Low disk space warning level** - Enter a percent value. When the remaining space falls below the specified value, the event will be displayed and a notification will be e-mailed (→ P. 62, 64).
- 4 **Reduce recording frame rate when disk is under high load** - When disk is highly loaded, recording frame rate is temporarily reduced to prevent the recording from stopped. Refer to Chapter 6 for details.



Tip

When Reduce recording frame rate when disk is under high load is checked, you will receive an event notification such as Effective “Recording rate (<recording rate before change> → <recording rate after change> %)”.
Ex. “Recording rate (100.0 → 90.0 %)”



Note

When the free disk space has fallen below the value specified in the Low Disk Space Warning Level field, an event occurs and an event notification mail is sent. Also, if the used disk space exceeds the value specified in the Maximum disk space used field, recorded video will not be saved until the required free disk space is secured. Refer to P. 58 for the disk space management.

Select Disk Drive Settings



1

Drive - Select the disk drive to configure, from the drop-down menu.

2

Maximum disk space used - Check the box and enter a value in Megabytes (MB) or Gigabytes (GB), for example, "50".

This establishes the maximum disk space used for all video files on the specified drive.

3

Add network Drive - Add a disk drive on the network used as the network drive. The added network drive is shown on the **Drive** drop-down menu.

4

Delete network Drive - Delete an added network drive.

Adding Removing a Network Drive

By adding a network drive, you can save recorded video data on a network drive such as NAS (Network Attached Storage) in addition to the internal HDD.

If you add a network drive in the Storage Server Configuration window, the drive will be added to the list of the pull-down menu of the **Add/Edit Camera Server** dialog (→ P. 87, 94).



Tip

When using the Storage Server with the local system account, the Add Network Drive and Delete Network Drive buttons are disabled.

To add a network drive...



1 Click **Add Network Drive**.

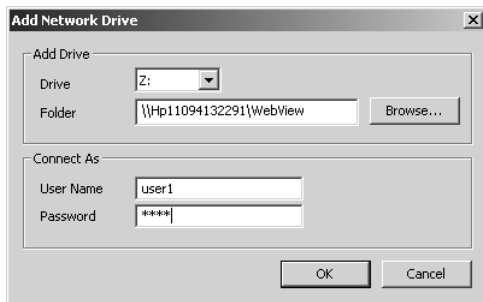

2 The **Add Network Drive** dialog appears. Select a drive to add as a network drive and enter a path assigned to the drive. You can also enter a path automatically by selecting a folder.

When selecting a folder with Browse...



Click **Browse...**, select a folder where you want to save recorded video data in the **Browse for Folder** dialog. Click **OK** to enter the path of the selected folder in the path field.

3 Enter the user name and password to access the network drive in the respective fields, and click **OK**.

Be sure to use different user name and password from the logon user name and password for the local system account.

If addition is successful, the added drive appears on the drive selection pull-down menu.

To remove a network drive...



Select a network drive and click **OK** to delete the selected drive from the Storage Server.



Note

● About Network Drive

VK-64/VK-16 can record videos on a drive on the network. The drive type is shown at the head of the Drive drop-down menu as “Internal disk: local, Network drive: network”.

● About Video Recording

If disk space is not enough to cover the specified value configured with Maximum disk space used, the retained duration of recorded video may be shorter than the specified period or the recording may be temporarily stopped. Please be sure to perform sufficient tests before starting operations.

● For details about disk space on the Storage Server, refer to “Disk Space Management” (→ P. 58).

● Windows does not allow a user who has logged in with a local system account (used for normal service management) to add a network drive. The Add network drive and Delete network drive items are disabled while you are logging into Windows with a local system account. To set the network drive, click Stop Storage Server to stop the Storage Server, and click the Logon Settings and switch to an account which is allowed to use the network drive (i.e., account with Windows' Administrator and Logon As Service privileges). Refer to P. 57 for the Logon As Service privilege.

● You cannot use a UNC path or removable disk when adding a network drive.

● If you add or delete a network drive, the Storage Server program will reboot.

● Multiple Storage Servers cannot use the same network drive simultaneously.

● Single network drive cannot allocate to multiple drivers.

● Internal information (thumbnails, location, zone, and recording schedules) related to a network drive will not be lost even if the network drive is deleted. Therefore, if you add the same network drive later, you can restore the status before deletion.

● If the selected network drive cannot be accessed because the network is disconnected, the selected drive is powered off, or you entered a wrong path, the following error message will appear.

“Network path cannot be found.”

● While the network drive is not operating (e.g., due to network disconnection), video will not be recorded until the drive recovers.

Start or Stop the Storage Server Program

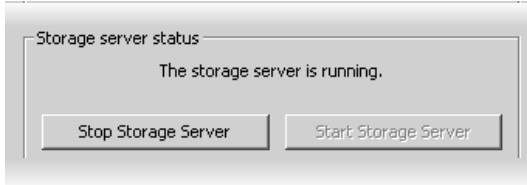

Click **Stop Storage Server** to stop the Storage Server.

Click **Start Storage Server** to start the Storage Server.



Note

If you need to stop the Storage Server Program, first inform all users connected to the storage server.

Change the Logon Settings



1

If you need to log onto the Storage Server with another account when using a network drive, click **Stop Storage Server**. After the Storage Server stops, click **Logon Settings**. The **Log on as** dialog appears.

2

If you are logging onto the Storage Server with a **Local System account**, select **Local System Account**. If you are logging onto the Storage Server with another account, enter the account in **Account** and password in **Password**.

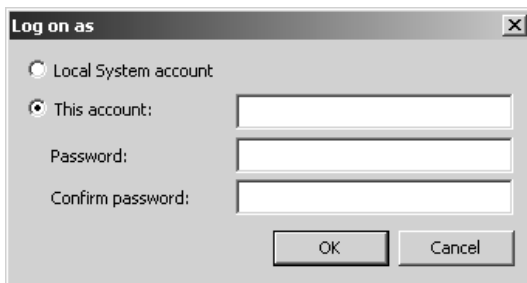

3

Click **OK**.

4

Click **Start Storage Server** to start the Storage Server with the specified account.

Message

When you have changed items affecting recording settings:

When you click **Apply** or **End**, the following message will appear.

“Item affecting recording setting has been changed.

To see how setting is affected, use Recording Setting Summary Display in the Recording Schedules window of the Viewer.”

When you have changed the Maximum retained history setting:

When you click **Apply** or **End**, the following message will appear.

“Changing the maximum retained history may delete recorded video. Are you sure to continue?”

When you have added or deleted a network drive:

When you click **Apply** or **End**, the following message will appear.

“Drive configuration has been changed and Storage Server must be restarted. Are you sure to restart Storage Server?”

Logon As Service Privilege

When you want to add the Logon As Service privilege to an existing Windows account so that you may be able to configure network drive settings, perform the following steps before **configuring the logon settings**.

- 1 Select **Control Panel, Performance and Maintenance, Administration Tool, and Local Security Policy** from the Windows' **Start** menu.

The **Local Security Settings** dialog appears.

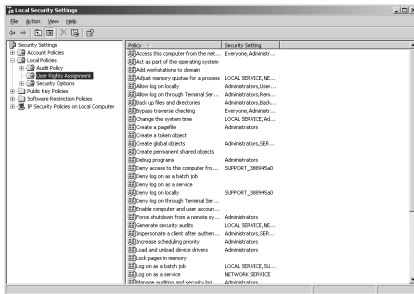

- 2 Select **Local Policy** and **User Privilege Assignment** from the tree to the left.

- 3 Double-click **Logon as Service** from the list to the right.

The **Logon as Service Properties** dialog opens.



- 4 Click **Add User or Group**. The **Select User or Group** dialog opens.

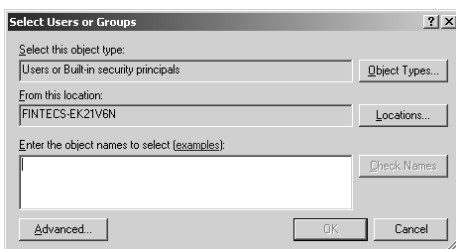

- 5 Enter the Windows account in the **Enter object name to select** field.

Enter or change the object name, location, and details as required.

- 6 Click **OK**. The **Logon as Service Properties** dialog reappears.

- 7 Click **OK**. The **Local Security Settings** dialog reappears.

- 8 Close the **Local Security Settings** dialog.

Disk Space Management <Important>

Disk Space Management Level

The Storage Server monitors the remaining disk space and takes a measure according to the current level.

- 1) Low Disk Space Warning Level
- 2) Threshold Level
- 3) Limit Level

Administrator can set the **Low disk space warning level** 1) using the Low Disk Space Warning Level field in the **Settings** tab.

The Storage Server calculates the values for Threshold Level 2) and Limit Level 3) according to various conditions and settings.

Counteraction at Each Level

The Storage Server performs the following when the disk space reaches each level.

In case of Low Disk Space Warning Level

The Storage Server generates an event when the disk space available for recording (i.e., free space from the Maximum disk space used value) has fallen down to a certain level.

If the **Maximum disk space used** field is blank, the entire drive capacity of the drive specified in the **Drive** field is considered to be the maximum disk space used.

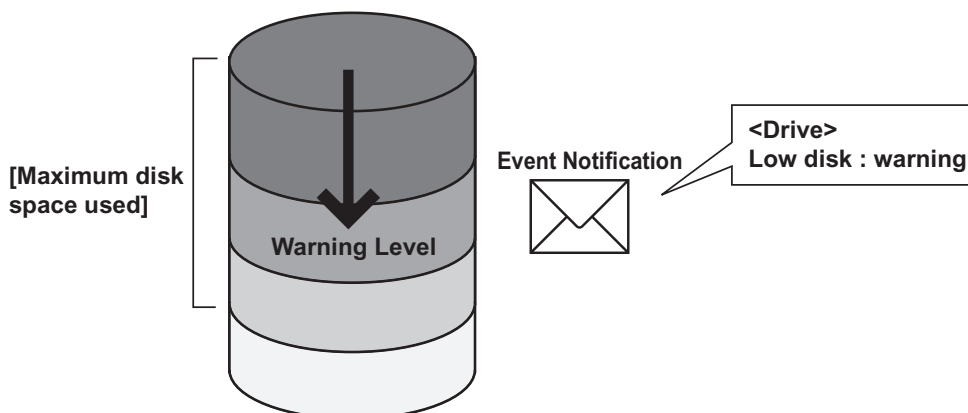

Note

The event notification e-mail is transmitted when the priority specified for the Low Disk Space Warning Level option in the Event tab of the Storage Server Configuration dialog is equal to or higher than the priority specified in the Event Notification tab. Refer to P. 62 and P. 64 for how to set the Events and Event Notification tabs.



Tip

This allows early intervention by an administrator to avoid problems due to running out of disk space (for example, removing unnecessary recording schedules).

In case of Threshold Level calculation level

The Storage Server continues recording video; however, it starts deleting the video files from the oldest ones, and generates an event.

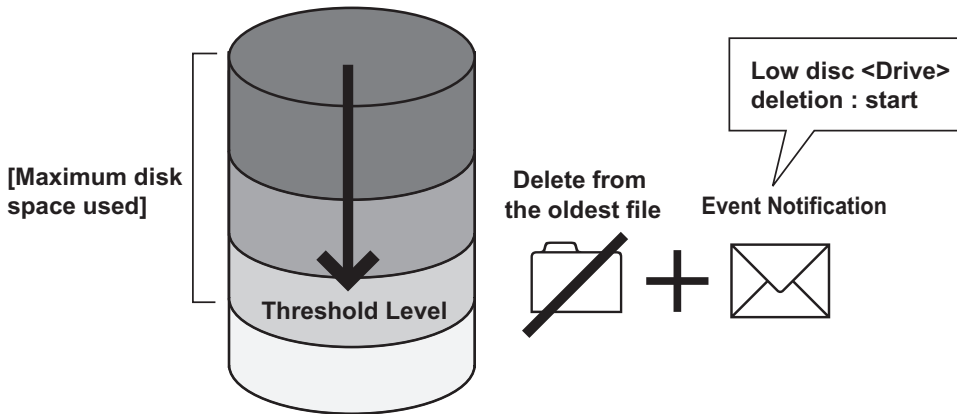

 **Tip** Old video files may be deleted even if these are within the “Maximum retained history” value. However if the oldest file is currently used in the Viewer (for example for playback of recorded video), it would not be deleted and the next oldest file will be deleted instead. Deletion will continue until the free space rises above this threshold again. Refer to Chapter 7 for saving files.

In case of Limit Level

The Storage Server stops recording video when the free disk space goes down to this level, and generates an event.

When the free disk space increases above this level by deleting old video files, the Storage Server resume recording video and generates an event.

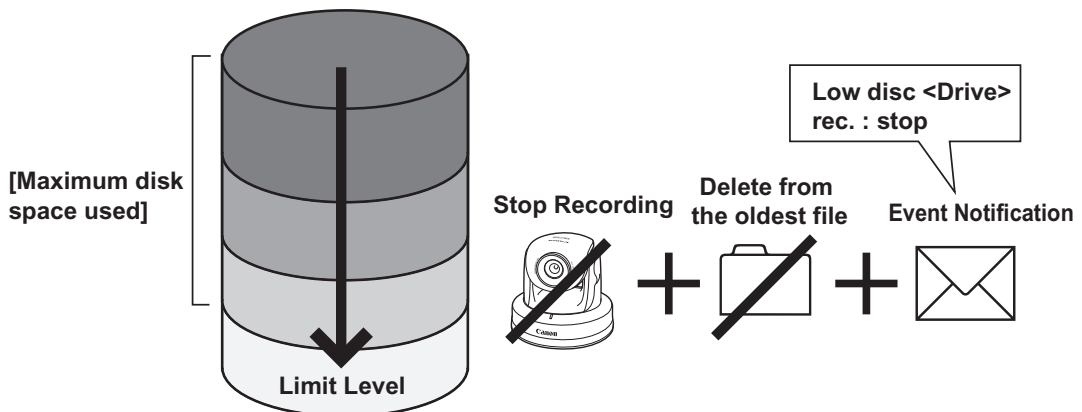

Low Disk Space Warning Level Calculation Method

The Low Disk Space Warning Level occurs when the Storage Server satisfies the condition 1) or 2) below.

1) **When the Storage Server disk space used exceeds the following value:**

$$M \times (100 - A) / 100$$

M: Value for **Maximum disk space used**

A: Value for **Low disk space warning level**

Example: When the value for **Maximum disk space used** is 100 GB and the value for **Low disk space warning level** is 10%, the Storage Server reaches the **Low disk space warning level** when the remaining free disk space becomes 10 GB or less.

2) **When free disk space falls below the following value:**

$$\text{Disk capacity} \times A / 100$$

A: Value for **Low disk space warning level**

Example: When the value for disk capacity is 80 GB and the value for **Low disk space warning level** is 10%, the Storage Server reaches the Low Disk Space Warning Level when the remaining free disk space becomes 8 GB or less.



Tip

If other applications are also using the same hard disk, you need to review the condition 2). Even if the Storage Server uses a small quantity of disk space, it may reach the Low Disk Space Warning Level because other applications has consumed disk space.

Threshold Level Calculation Method

The Low Disk Space Warning Level occurs when the Storage Server satisfies the condition 1) or 2) below.

1) **When the Storage Server disk space used exceeds the following value:**

a. **Maximum disk space used** is 384 MB or more,

$$\text{Maximum disk space used} - 96\text{MB}$$

b. **Maximum disk space used** is 384 MB or less,

$$\text{Maximum disk space used} \times 3/4$$

2) **When free disk space falls below the following value:**

$$(\text{Number of Camera Servers} + 1) \times 32\text{MB} + 96\text{MB}$$

Limit Level Calculation Method

The Limit Level occurs when the Storage Server satisfies the condition 1) or 2) below.

1) **When the Storage Server disk space used exceeds the following value:**

Maximum disk space used

2) **A When free disk space falls below the following value:**

(Number of Camera Servers + 1) x 32MB

Calculation Example for Each Level

Disk Drive	Disk Capacity	Free Disk Space	Max. Disk Space Used	Camera Server No.
C Drive	100GB	50GB	40GB	19 units
D Drive	200GB	200GB	200GB	19 units

The following is a table of values for each level calculated based on the above examples.

Disk Drive	Low Disk Warning Level	Threshold Level	Limit Level
C Drive	1) $40\text{GB} \times (100-10) / 100 = \mathbf{36\text{GB}}$ 2) $100\text{GB} \times 10 / 100 = \mathbf{10\text{GB}}$	1) $40\text{GB} - 96\text{MB} = \mathbf{39.904\text{GB}}$ 2) $(19+1) \times 32\text{MB} + 96\text{MB} = \mathbf{736\text{MB}}$	1) 40GB 2) $(19+1) \times 32\text{MB} = \mathbf{640\text{MB}}$
D Drive	1) $200\text{GB} \times (100-10) / 100 = \mathbf{180\text{GB}}$ 2) $200\text{GB} \times 10 / 100 = \mathbf{20\text{GB}}$	1) $200\text{GB} - 96\text{MB} = \mathbf{199.904\text{GB}}$ 2) $(19+1) \times 32\text{MB} + 96\text{MB} = \mathbf{736\text{MB}}$	1) 200GB 2) $(19+1) \times 32\text{MB} = \mathbf{640\text{MB}}$



Note

- “Threshold Level” can be used as a protective level so that the “Limit Level” is not achieved. It is recommended that you take measures when “Low Disk Space Warning Level” event notification is generated, such as deleting unnecessary video files.
- Storing video data above the Threshold Level increases load over the Storage Server and may cause recording interruption. It is strongly recommended to use the Storage Server below the Threshold Level.
- Refer to “Operation Guideline for Recording and Viewing” (→ P. 208) for details of operation.
- For each of the levels, the system can be configured to provide e-mail notifications when one of these levels is reached (→ P. 64).
- The requirements of “Threshold Level” may be achieved before the requirements of “Low Disk Space Warning Level” are satisfied, depending on circumstances. For example, large numbers of cameras with limited disk capacity may bring a larger value for “(Numbers of camera +1) x 32 MB + 96 MB”, compared with the value of “Disk capacity x Low disk space warning level/100”.

Setting the Events Tab

The **Storage Server Configuration** dialog, **Events** tab allows you to specify event priorities.

If you have configured the event notification e-mail settings, e-mails are sent according to the priorities set in the **Events** tab.

How to Display the Events Tab

Double-click the **Storage Server Configuration** desktop icon.

The **Storage Server Configuration** dialog opens and the **Settings** tab is displayed.

Click the **Events** tab to open it.

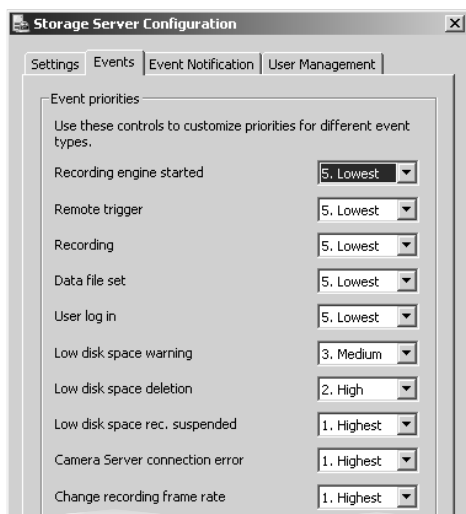

How to Set the Events Tab

● Set the Event Priority

Select the priority for the event from the Priority drop-down menu.

Item	Setting
Recording engine started	1. Highest, 2. High, 3. Medium, 4. Low, 5. Lowest
Remote trigger	1. Highest, 2. High, 3. Medium, 4. Low, 5. Lowest
Recording	1. Highest, 2. High, 3. Medium, 4. Low, 5. Lowest
Data file set	1. Highest, 2. High, 3. Medium, 4. Low, 5. Lowest
User log in	1. Highest, 2. High, 3. Medium, 4. Low, 5. Lowest
Low disk space warning	1. Highest, 2. High, 3. Medium , 4. Low, 5. Lowest
Low disk space deletion	1. Highest, 2. High , 3. Medium, 4. Low, 5. Lowest
Low disk space rec. suspended	1. Highest , 2. High, 3. Medium, 4. Low, 5. Lowest
Camera Server Connection error	1. Highest , 2. High, 3. Medium, 4. Low, 5. Lowest
Change recording frame rate	1. Highest , 2. High, 3. Medium, 4. Low, 5. Lowest
Filed to map a network drive	1. Highest , 2. High, 3. Medium, 4. Low, 5. Lowest

Values shown in bold are the defaults.



Note

- Events associated with “Recording”, “User log in”, and “Filed to map a network drive” do not appear in a Viewer’s Timeline (→ P. 192), Live Events Log (→ P. 199), or Event Search Dialog (→ P. 201).
- To detect such a event, set the e-mail notification using the Event Notification tab (→ P. 64).



Tip

- Remote Trigger function starts recording by passing a certain command from an external program to the VK-64/VK-16. Ask our sales person for the details.
- If the priority is not specified for manual recording and custom recording using the Remote Trigger function, the priority specified here will be used.

Setting the Event Notification Tab

The **Storage Server Configuration** dialog, **Event Notification** tab allows you to configure.

Configure the e-mail notification settings according to the priorities set in the **Events** tab.

How to Display the Event Notification Tab

Double-click the **Storage Server Configuration** desktop icon.

The **Storage Server Configuration** dialog opens and the **Settings** tab is displayed.

Click the **Event Notification** tab to open it.

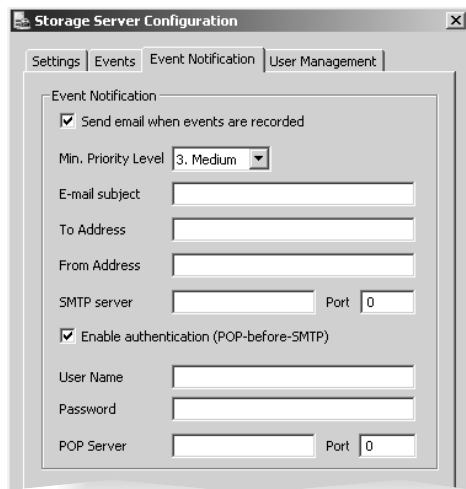

How to Set the Event Notification Tab

● Set the Event Notification Priority

- 1 Check the **Send E-mail when event occurs option** and select the **priority level** for sending e-mails from the Priority drop-down menu. Events of that priority and above will lead to notification e-mails.

A close-up view of the 'Event Notification' form fields. It shows three input fields: 'E-mail subject', 'To Address', and 'From Address'. Each field is a simple rectangular text box.

- 2 Enter a subject in the **E-mail subject** line (e.g., "Immediate Action Required"), recipient's address in the **To Address:** line, and sender's address in the **From Address:** line.

 **You can enter each of the subject, recipient’s address, and sender’s address in up to 100 characters.**
 Note

 **You can only register one e-mail address in the To Address field. If you want to send the e-mail to multiple addresses, use a group address.**
 Tip

SMTP server Port

3 Enter the host name or IP address of the SMTP server in **SMTP Server** and port number in **Port**.

 **Enter the host name in up to 255 characters.**
 Note

User Name
 Password
 POP Server Port

4 If you want to use “POP-before-SMTP” for user authentication, check the **Use POP-before-SMTP** option, and enter the user name used for authentication in **User Name** and password in **Password**. Also, enter the host name or IP address of the **POP server** in **POP Server** and port number in **Port**.

 **• Enter the user name in up to 100 characters.**
• Enter the password in up to 20 characters.
• Enter the host name in up to 255 characters.
 Note

 **If this is enabled, the Storage Server will attempt to perform a POP login before sending e-mail that may be required for some SMTP servers.**
 Tip

Example event notification e-mail

An event of priority 3 occurred on 12/05/2006 at 15:15:17 +1000.
 Parking Lot 1: Sensor on

Setting the User Management Tab

The **Storage Server Configuration** dialog, **User Management** tab allows you to set up users and their privileges.

How to Display the User Management Tab

Double-click the **Storage Server Configuration** desktop icon.

The **Storage Server Configuration** dialog opens and the **Settings** tab is displayed.

Click the **User Management** tab to open it.

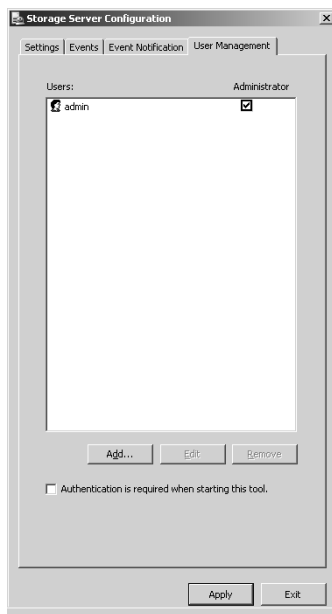

Administrator and Operator Status User

Administrators have access to the Viewer including Camera Server setup, recording schedules and Viewer setup.

Operator Status Users can only access the Viewer windows (→ P. 162) created by Administrator. Also, they only have access to live video and recorded video on Storage Servers they have permission to access.



Note

- **Users who have Operator Status cannot configure, register and change Camera Servers, or configure and change recording schedules.**
- **By default, a user called “admin” is created. The password is “NVR”. It is strongly recommended to change the user name and password after installation.**
- **It is necessary to set up users on all Storage Servers. A particular user should be set up to have the same password on each Storage Server.**

How to Set the User Management Tab

Add a User

- 1 Click **Add** on the **User Management** tab.
The **Add User** dialog appears.
- 2 Enter the user's **User Name** (up to 20 characters, including alphanumeric letters and underscore "_").
- 3 Enter the user's **User Name** (up to 20 characters, including alphanumeric letters and underscore "_"). The **Confirm Password** field will become active. Re-enter the new password.
- 4 Click **OK**.
The dialog closes and the new user is displayed in the User List.

Changing User to Administrator

- 1 Check the **Administrator** option of a user in the User List to enable the user to have the Administrator privileges. Do not check the option if you do not want to enable the user to have the Administrator privileges.
- 2 Click **Apply** to save changes.



Note

The VK-64/VK-16 Administrator status is independent of the Windows Administrator status.

Change User Password

- 1 Click to select a user to change the password in the User List.
- 2 Click **Edit** below the user list to bring up the **Edit User** dialog.
- 3 Enter the user's **User Name** (up to 20 characters, including alphanumeric letters and underscore "_"). The **Confirm Password** field will become active. Re-enter the new password.
- 4 Click **OK**.
The new password is saved.

Delete a User

- 1 Click to select a user to delete in the User List.
- 2 Click **Remove**.
The user is deleted.

Request User Authentication at Tool Startup

Authentication is required when starting this tool.

Check the **Authentication is required when starting this tool** if user authentication is required when launching the tool. If this option is checked, the **Login** dialog appears before the **Storage Server Configuration** dialog opens.

Chapter 4

Registering Camera Server and Setting Recording Schedule

Chapter Overview

This chapter explains how to store Camera Servers necessary for creating recording schedules on the Storage Server, as well as the procedure to create recording schedules.

To store the Camera Servers and create recording schedules, launch the VK Viewer and use the **Camera Summary** window and **Recording Schedules** window under the Configuration and Preferences screen.

Launching the VK Viewer and Displaying the Configuration and Preferences Screen

Launching Procedure



Double-click the **VK Viewer** desktop icon.

Alternatively, from the Windows **Start** menu select: **All Programs > WebView Livescope > Network Video Recorder VK Series v1.3 > VK Viewer.**

The connect option menu (Start-up Screen) for Storage Server is displayed. Select **Master Storage Server** option and click **Connect**.

Start-up Screen



localhost

Connects to Storage Server and starts the Viewer. Select this option to use the local PC where Viewer is installed as the Master Storage Server.

Use IP address

Connects to Storage Server and starts the Viewer by specifying its IP address. Select this option when the Storage Server and the Viewer are installed on separate PCs.

Not use Storage Server

Select this option to use the Viewer only without connecting to a Storage Server.



Note

If you want to add a Storage Server to the connect option menu, login the desired Storage Server by specifying its IP address and click Add Storage Server in the Viewer Settings window (→ P. 157).



Tip

- If multiple Storage Servers are being used, you should decide which one is the Master Storage Server.
- If the Storage Servers v1.2 and v1.3 coexist, either Storage Server can be specified as the Master Storage Server.
- The Viewer v1.0, v1.1, or v1.2 cannot connect to the Storage Server v1.3.
- If you want to connect to the Storage Server directly without displaying Start-up Screen, uncheck When starting Master Storage Server is selected in the Viewer Settings window (→ P. 157).

Launching by Connecting to the Localhost

If you want to use the local PC where Viewer is installed as the Master Storage Server, select **localhost** to start the Viewer.



1 Select **localhost** from the drop-down menu.

2 Click **Connect**.

3 Enter your **User Name** and **Password**, and click **Login**.



Tip

- The default user name and password are as follows:

User name: admin

Password: NVR

It is strongly recommended to change the user name and password after installation.

- The Viewer can be launched directly without displaying Start-up Screen and Login dialog (→ P. 157).

Specify the IP address of Storage Server to connect Viewer

If you installed the Viewer and Storage Server on separate PC, specify an IP address of Storage Server and connect Viewer to the Storage Server.



1 Select **Use IP address** from the drop-down menu.

2 Click **Connect**.



3 Enter the IP address or host name of the Master Storage Server in **Host Name or IP**, and the port number in **Port**.

4 Click **Connect**.



5 Enter your **User Name** and **Password**, and click **Login**.



Note

- If you need to use a proxy server, you need to change the Internet option settings in the following procedure:
 1. Select Start > Control Panel > Internet Option.
 2. Select the Connection tab.
 3. Click LAN settings
Change the proxy server settings.
- If using a proxy server between a Viewer and a Storage Server, it should be one which does not perform response buffering. Proxies which are configured to perform response buffering may lead to delays in sending small amounts of data (such as events) from the Storage Server to the Viewer. You cannot use the Apache proxy server since it perform response buffering.
- You cannot transmit or receive audio when using a proxy server.



Tip

The dialog for entering the IP address will also be shown even when connection to the Storage Server failed.

Launching the VK Viewer and Displaying the Configuration and Preferences Screen

When the Viewer accesses a Master Storage Server which has not been set up with camera information, the entire Viewing Screen is initially blank as shown below. You will need to configure the Viewer using the **Configuration and Preferences** screen.

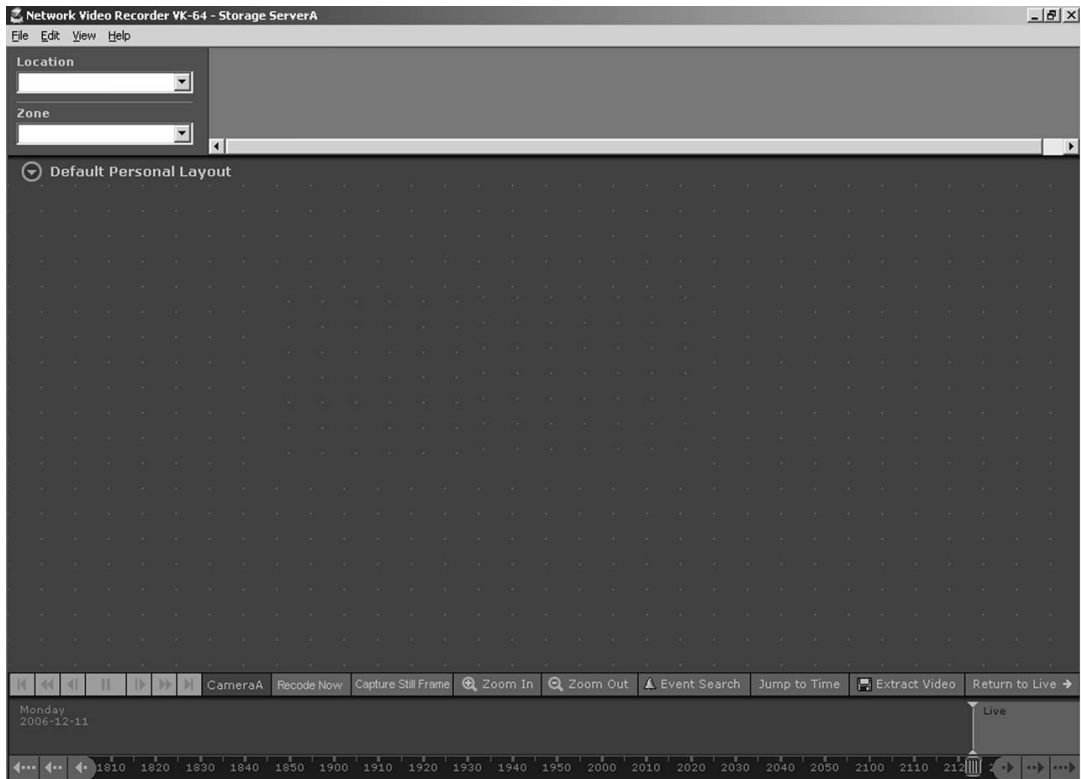

Note

It is strongly recommended that only one Administrator perform configuration on each network.

Accessing the Configuration and Preferences screen

To open the **Configuration and Preferences** screen.

● **In the Menu Bar, select View → Configuration**

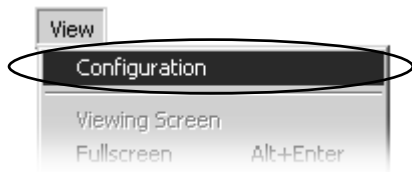

The menu bar is located at the top left of the Viewing Screen.

In the Menu Bar, select **View → Configuration**.

The **Configuration and Preferences** screen appears.

Storage and Camera Server Summary windows

Use the **Storage and Camera Server Summary** screen to create a location and zone, add the Storage Server, and add the Camera Server.

Displaying the Storage and Camera Server Summary Windows

- 1 Launch the VK Viewer and display the **Configuration and Preferences** screen.

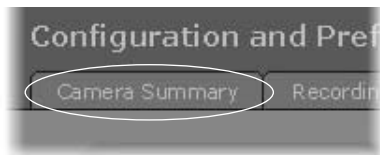

- 2 Click the **Camera Summary** tab. The **Storage and Camera Server Summary** windows appear.

The window consists of two sub-windows which are opened by their respective tabs, **Storage Servers** and **Locations/Zones**.

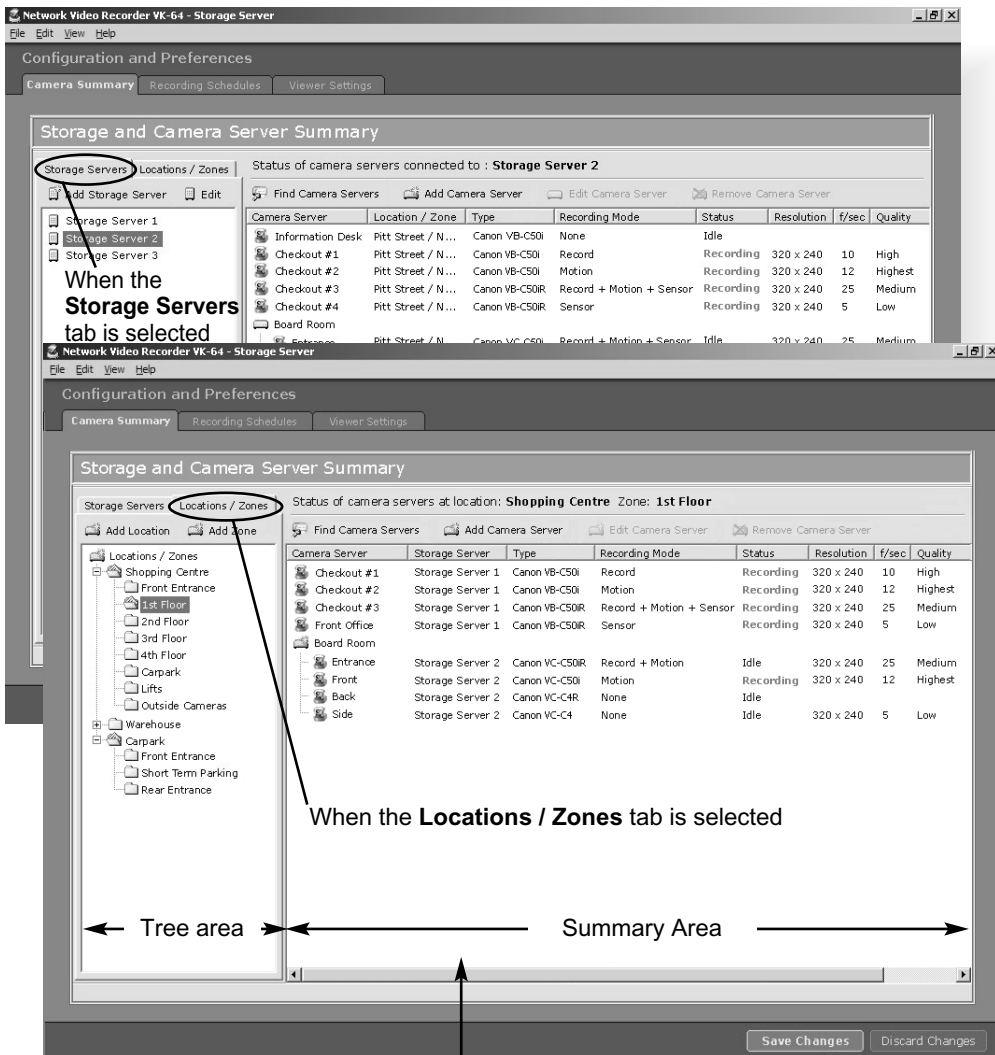

Click and drag scrollbar(s) to view any portions of the Summary Area that are not visible.



If you are using the Viewer only, the Camera Server, Location/Zone, and Camera Type are only shown in the Camera Server List.

Click and drag divider line to the right to reveal full values.

Camera Server	Storage Server	Type	Recording Mode	Status	Resolution	f/sec	Quality
Checkout #1	Storage Server 1	Canon VB-C50i	Record	Recording	320 x 240	10	High
Checkout #2	Storage Server 1	Canon VB-C50i	Motion	Recording	320 x 240	12	High

Storage Servers and Locations/Zones options

The following options are available via the **Storage Servers** tab.



Add Storage Server - Allows you to register a Storage Server with the system (up to ten Servers are recommended).

Edit - Allows you to change the address of the selected Storage Server.

Select a Storage Server from the tree in the left panel. The right panel will update with a list of Camera Servers recorded by the Storage Server you selected.

The following options are available via the **Locations/Zones** tab.



Add Location - Allows you to add a new location to the system.

Add Zone - Allows you to add zones to locations.

When you select a zone within a location in the left panel, a list of cameras in that zone is displayed in the right panel.

Other Functions in Both Tabs



Camera server functions are located on the right-hand panel regardless of which tab is selected.

- **Find Camera Servers** - Allows you to initiate a network search for unlisted Camera Servers on the LAN.
- **Add Camera Server** - Allows you to add a Camera Server to the system.
- **Edit Camera Server** - Allows you to edit an existing Camera Server's settings.
- **Remove Camera Server** - Allows you to remove a Camera Server from the system.

Location and Zone

Create a location and zone before registering the Camera Server.

Cameras are grouped into Locations and Zones. Locations are for example, an office building, shop or school. Zones are a part of Locations, that is, a zone could be assigned to each floor in the office building and specific areas in a shop such as a cash register area.

The diagram below illustrates an example of physical Locations and Zones on a VK-64/VK-16 network. Viewer access is via the **Location** and **Zone** drop-down menus.

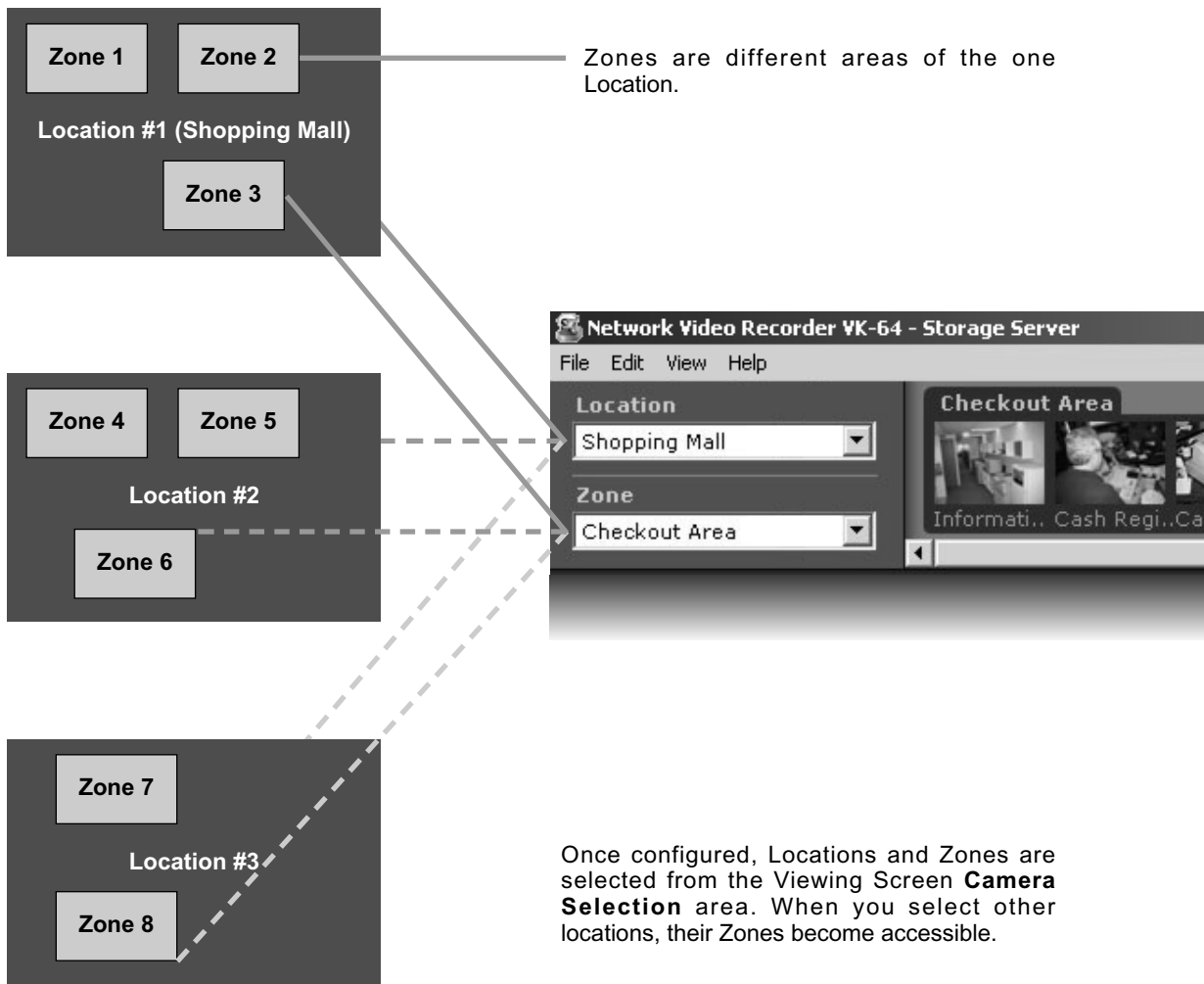

When a Location is selected from the drop-down menu at left, all of the Zones associated with the Location will appear to the right as camera thumbnail images.

This tab containing four thumbnail images indicates that there are four cameras in the Zone.



This tab containing six thumbnail images indicates that there are six cameras in the Zone.



Note

- The Location/Zone hierarchy is independent of the grouping of cameras into Storage Servers. For example, a single Storage Server may record video from multiple Locations, and cameras from a single Location can be recorded to multiple Storage Servers.
- When more than one Storage Servers are used and a Storage Server which already has registered Camera Servers is changed to the Master Storage Server, thumbnails of registered Camera Servers may not be displayed. In this case, update the thumbnails by clicking Connect on the Edit Camera Server dialog for each Camera Server on the Master Storage Server.

Adding a Location or Zone

Step 1: Click Add Location on the Locations/Zones tab



- 1 In the **Camera Summary** window, select the **Locations/Zones** tab if it is not already selected.
- 2 Click **Add Location** to bring up the **Add Location** dialog.

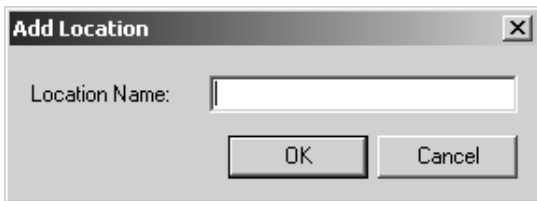

- 3 Enter the name of the new location (up to 20 characters), then click **OK**.

Step 2: Click Add Location on the Locations/Zones tab



- 1 In the **Camera Summary** window, select the **Locations/Zones** tab if it is not already selected.
- 2 Click **Add Zone** to bring up the **Add Zone** dialog.

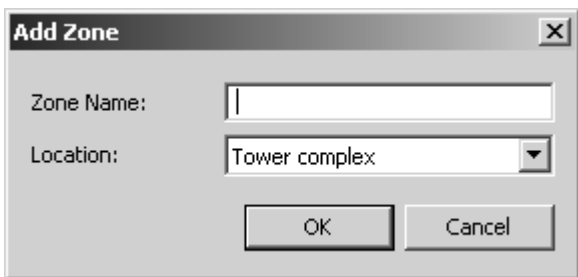

- 3 Enter the name of the new zone (up to 20 characters).
- 4 Select a location from the drop-down menu in the **Location** field, then click **OK**.

The selected zone will now appear in the specified Location folder.



Note

- If you want to add a Zone to another location not listed, you must first create the Location before you add the Zone.
- Each Location name must be unique and each Zone name within a Location must be unique.
- There is no fixed limit on the number of Zones and Locations that can be added.

Editing a Location or Zone

- 1 Double-click a location or zone.
The **Edit Location** or **Edit Zone** dialog opens.
- 2 Enter connection settings and click **OK**.

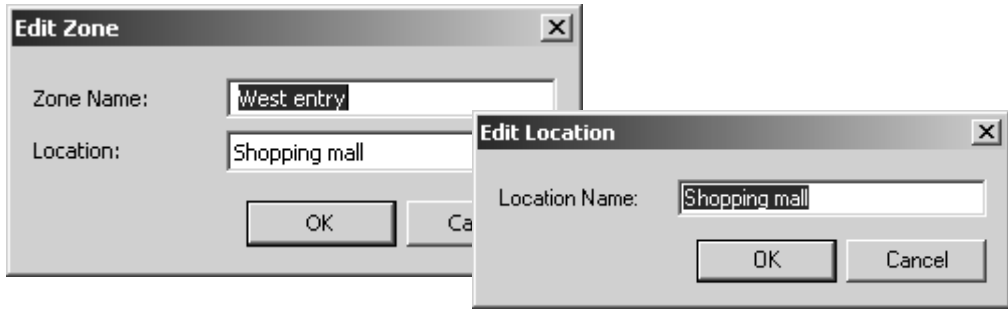

Deleting a Location or Zone

- 1 Click a location or zone in the list to highlight it and select **Delete** from the **Edit** menu.
Alternatively, click a location or zone to select it, then press the **Delete** key on your keyboard.
- 2 A confirmation dialog will appear. Click **Yes**.
Click **No** to cancel deletion.

Adding the Storage Server

If you are using multiple Storage Servers, add each Storage Server as directed below. You need not perform these steps if you are using only one Storage Server and that Storage Server has already been added.

By adding the Storage Server, you can select the Camera Servers managed by the Storage Server from the Viewer screen.



Note

If you are using the Viewer only, the Storage Servers tab is not shown and you cannot add the Storage Server.



Tip

You can operate VK-64 with up to ten Storage Servers using any Up to 192 Camera Servers can be operated.

Displaying the Storage and Camera Server Summary Windows

Launch the VK Viewer and display the **Storage and Camera Server Summary** window.

Adding the Storage Server



1

In the **Storage and Camera Server Summary**, select the **Storage Servers** tab.

2

Click **Add Storage Server** to bring up the **Add Storage Server** dialog.

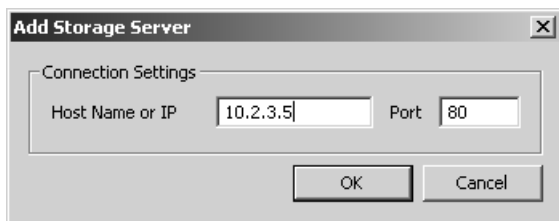

3

Enter connection settings and click **OK**.



Note

- Do not add the same Storage Server more than once.
- If you add a Storage Server with a different configuration (such as one managed by another Master Storage Server), your original Locations and Zones will be lost.
- If you are using Windows XP SP2 or Windows Server 2003, you need to change Windows settings. Refer to “Notes on Operating Environment” (→ P. 24).
- Do not change the port number.

Editing the Storage Server

- 1 In the **Storage and Camera Server Summary**, select the **Storage Servers** tab.
A list of Storage Servers already added are displayed.



- 2 Double-click the Storage Server in the list.

Alternatively, select the Storage Server and click **Edit**.

This will bring up the **Edit Storage Server** dialog.

- 3 Enter connection settings and click **OK**.



Note

- This function lets you change the network address used to access a particular Storage Server in case the IP address has changed.
- The Master Storage Server cannot be edited.

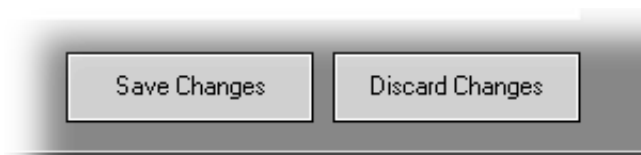

- 4 To save changes, click **Save Changes** at the bottom right-hand corner of the **Camera Summary** window.

Click **Discard Changes** to cancel any changes you have made.

Deleting the Storage Server

- 1 In the **Storage and Camera Server Summary**, select the **Storage Servers** tab.
A list of Storage Servers already added is displayed.
- 2 Click a Storage Server in the list to highlight it and select **Delete** from the **Edit** menu.
Alternatively, click a Storage Server to select it, then press the **Delete** key on your keyboard.
- 3 A confirmation dialog will appear. Click **Yes**.
Click **No** to cancel deletion.



- 4 To save changes, click **Save Changes** at the bottom right-hand corner of the **Camera Summary** window.

Click **Discard Changes** to cancel any changes you have made.



Note

- If a Storage Server is deleted, all Location, Zone, thumbnail and Layout information for cameras associated with this Storage Server will be lost.
- The Master Storage Server cannot be edited.

Registering Camera Server

After preparing for Camera Server registration (i.e., creating a location and zone, and adding the Storage Server), you can register the Camera Server.

You must register the desired Camera Server on the Storage Server if it has not been registered.

Storing the Camera Server (by Search)

After registering the Camera Server, you can select the Camera Server from the Viewer screen.



Tip

- Up to 192 Camera Servers can be operated.
- To connect to the Camera Server managed by another Storage Server, you must first add that Storage Server (→ P. 82).

● Displaying the Storage and Camera Server Summary Windows

Launch the VK Viewer and display the **Storage and Camera Server Summary** window.

● Finding the Camera Server



In the **Camera Summary** window, click **Find Camera Servers** which is located above the right-hand panel.

The **Search Results** dialog opens and a list of detected Camera Servers will appear.

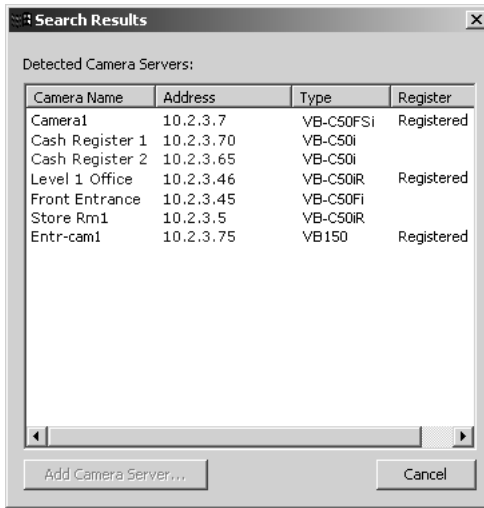

Note

- When you initiate the Find Camera Servers function, your computer searches the Viewer's local subnet for all Camera Servers connected to it. Camera Servers on another subnet cannot be searched and must be added using Add Camera Servers (→P. 87).
- The camera names listed are those specified by the Camera Server. Refer to the Camera Server's User's Manual for more information on setting the name ("Camera Name" for VB-C50i/ VB-C50iR, VB-C50FSi, VB-C50Fi, VB-C10/VB-C10R, "Device Name" for VB150 and VB101, and "VB-C300NA" or "VB-C300PA" for VB-C300).



Tip

- If you cannot find the Camera Server, click Add Camera Server to add it.
- For the Camera Servers which are already registered, "Registered" is displayed in the "Register" column. The "Register" columns for unregistered Camera Servers are blank.

Adding the Camera Server

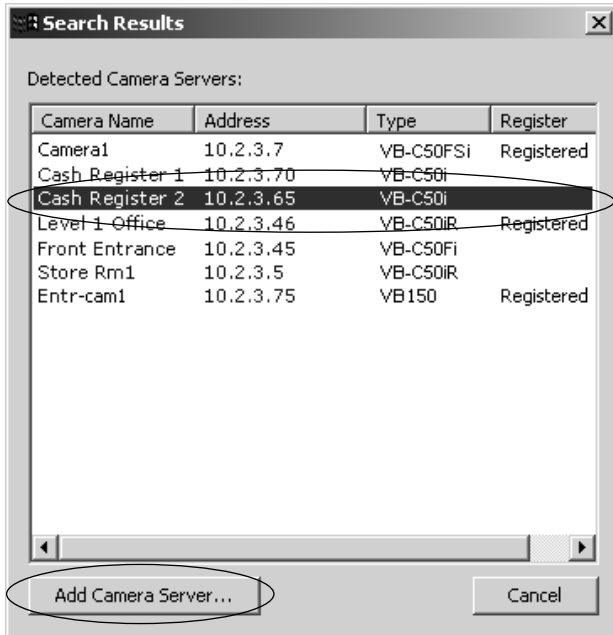

1 In the **Search Results** dialog, click a Camera Server in the search results list to select it.

2 Click **Add Camera Server...** The **Add Camera Server** dialog appears.

Alternatively, double-click an item to bring up the **Add Camera Server** dialog.

Continue settings on the **Add Camera Server** dialog.

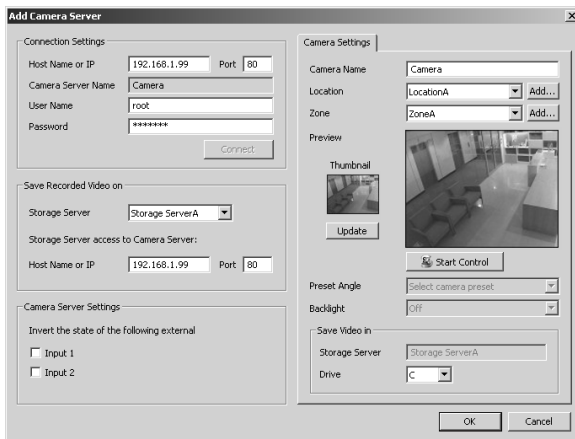

Recording schedules must be set in order to record video. Clicking OK does not immediately start recording video.



The Add Camera Server dialog's appearance will depend on the type of Camera Server connected.

Connecting to Camera

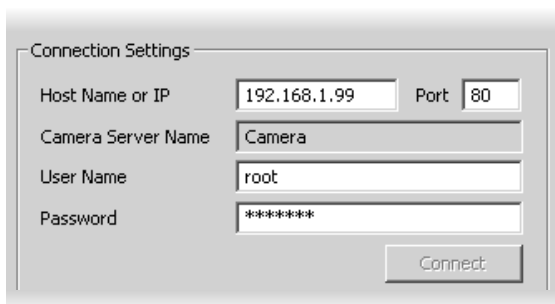

Connection Settings

Host Name or IP: 192.168.1.99 Port: 80

Camera Server Name: Camera

User Name: root

Password: *****

Connect

1

Enter the Host Name or IP address in **Host Name or IP**, then enter the port number for the Camera Server in **Port**.

The **Host Name or IP** must be 255 characters or less (each label, separated by a period, must be 63 characters or less), the IP address must be 15 characters or less (each label, separated by a period, must be 3 characters or less), and the **Port** must be a figure within the range from 1 to 65535.

2

Enter the user name and password to connect to the Camera Server. Enter the user name in **User Name** and password in **Password**.

The settings are then saved to the Storage Server.



Note

Use the user name and password configured on the Camera Server. If the user name and password are not sure, ask for the System Administrator of the Camera Server.

3

Click **Connect**.

Once the Viewer has connected with the Camera Server, a tab is shown next to the **Add Camera Server** dialog.



Note

- You must click **Connect** before clicking **OK** to close the dialog (the **OK** button is disabled until you do so).
- When two or more cameras are used with VB150 (when “Video Input” is set to “Single”), two through four tabs are added. The number of tabs shown for a VB150 does not indicate the physical number of cameras connected, but indicates the number of cameras which have been enabled using the VB150 Camera and Video Settings Page. Please refer to Chapter 3, P. 36 of the VB150 User’s Manual for more details.
- For VB101 (or VB150 when “Video Input” is set to “Single”), the camera name displayed as the Camera Server Name is the first camera name in the server’s camera name list. Therefore, it is recommended that the Administrator should set the first camera name to be a general name, applicable to the entire Camera Server.
- If you are using a VB101 or VB150 with the “Settings Web page URL” other than the default setting “admin”, a connection error occurs when you click **Connect**. Restore the default setting and try again.



Tip

If you have a Multi-Terminal Module VB-EX50 unit plugged into a VB-C50i/VB-C50iR, VB-C50FSi, VB-C50Fi and have configured the “Use External Video Input”, video seen in the Viewer may be taken from cameras connected to the Multi-Terminal Module. Switch the video at the Admin Viewer as required.

Selecting the Storage Server

1

Select a **Storage Server** from the drop-down menu which lists pre-configured Storage Servers and enter the Host Name or IP address in **Host Name or IP** and Port number in **Port**.

The **Host Name or IP** must be 255 characters or less (each label, separated by a period, must be 63 characters or less) and the **Port** number must be a figure within the range from 1 to 65535.

2

If you do not want the Camera Server to record video, select **Do not record** from the drop-down menu of **Storage Server**.



Note

- Recording schedules must be set in order to record video.
- There is a maximum number of 64 Camera Servers that can be registered on one Storage Server with VK-64 (or 16 cameras with Network Video Recorder VK-16).
- If you are using the Viewer only, the Storage Server cannot be configured.
- If you have changed the Camera Server’s IP address, you also need to change the host names in the Connection Settings and Storage Server Settings dialogs.

Configure External Device Input

To switch On or Off the external device input, check the **Invert the state of the following external** option.

One or more inputs may show depending on the type of the Camera Server. It is not necessary to change this setting if it is not required.

Assign a location and zone

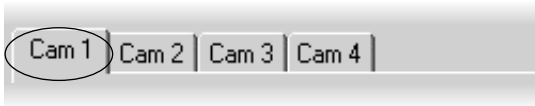

1 If multiple **Cam** tabs are shown to the right of the screen, select a tab for the Camera Server to edit settings.

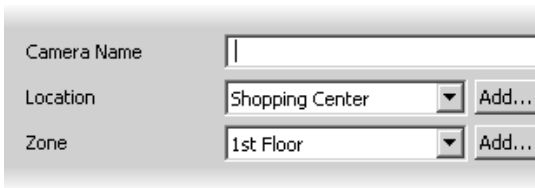

2 Change the name of the Camera Server in the **Camera Name** field as required.



Note

- Enter the Camera Name in up to 15 characters.
- Changing the Camera Name setting here does not change the camera name of the Camera Server.

3 In the **Location** field, select a location for the Camera Server from the drop-down menu.

4 In the **Zone** field, select a zone for the Camera Server from the drop-down menu.

If necessary, click Add... to add another Location or Zone.

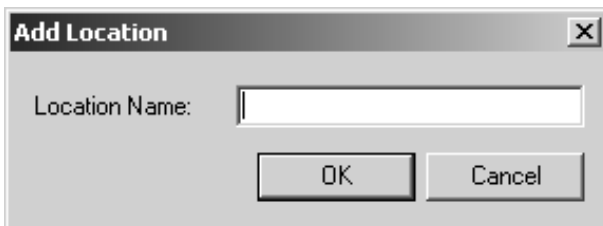

The **Add Location** or **Add Zone** dialog opens.

Enter the **Location Name** or **Zone Name** and click **OK**.

When you add a Zone in the **Add Zone** dialog, you must also add it to a Location in the same dialog.

Select a location from the drop-down menu.

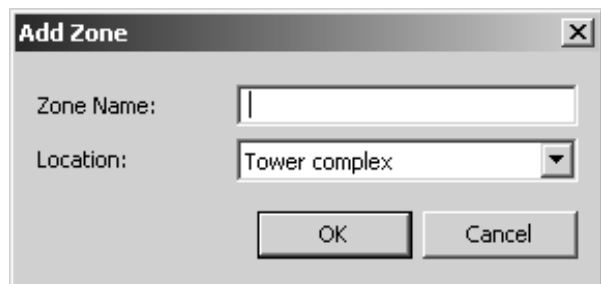

Refer to P. 80 for how to add locations and zones.

Update or Set the Viewer Thumbnails



1 In the **Preview** area, click **Update** to capture an image used for the thumbnail of the Viewer screen.

2 To change the camera angle or zoom magnification using the mouse, click **Start Control**.



Move the mouse cursor around the image. Arrows will appear and you can click and drag the cursor in that direction. The preview will change accordingly. When you move the mouse cursor to the center of the image, a zoom in or zoom out control will appear.

Hold down the mouse on “+” to zoom in.

Hold down the mouse on “-” to zoom out.



Note

- For a VB-C50FSi and VB-C50Fi, only zoom is available.
- If a fixed camera or an external camera such as VC-C50i is connected to VB-C50i, you cannot use pan, tilt, and zoom operations.



Tip

If you want to change the thumbnail and the preview area is blank (and the Update and Start Control buttons are disabled), click **Connect** (located in the Connection Settings field).

3

Choose a pre-defined camera position (if already configured) from the **Preset Angle** drop-down menu.



Tip

- Presets need to be configured in advance. Please refer to the Camera Server User’s Manual for details on making camera presets.
- If predefined presets are not shown in the Preset Angle drop-down menu even if they have been defined on the Camera Server, click Camera Control to display the Camera Control Panel, obtain camera control, then configure the settings again.

Select the drive to save video data.



Save video in

Storage Server: Storage Server

Drive: D

In the **Drive** menu, select a hard disk drive on the Storage Server.



Note

- Network drives registered via Storage Server Configuration are also shown on the Drive drop-down menu. Refer to “Selecting Disk Drive Settings” (→ P. 52) for the details.
- If you are using the Viewer only, the drive cannot be configured.

Closing the Add Camera Server Dialog

Click **OK** to close the **Add Camera Server** dialog.

If you invoked the **Add Camera Server** dialog from the **Search Results** screen, you will return to the **Search Results** screen.

Click **Cancel** to return to the **Camera Summary** window.

If you clicked **Add Camera Server** to invoke the **Add Camera Server** dialog, you will return to the **Camera Summary** window.

Save Settings

To save Camera Server settings, click **Save Changes** at the bottom right-hand corner of the **Camera Summary** window.

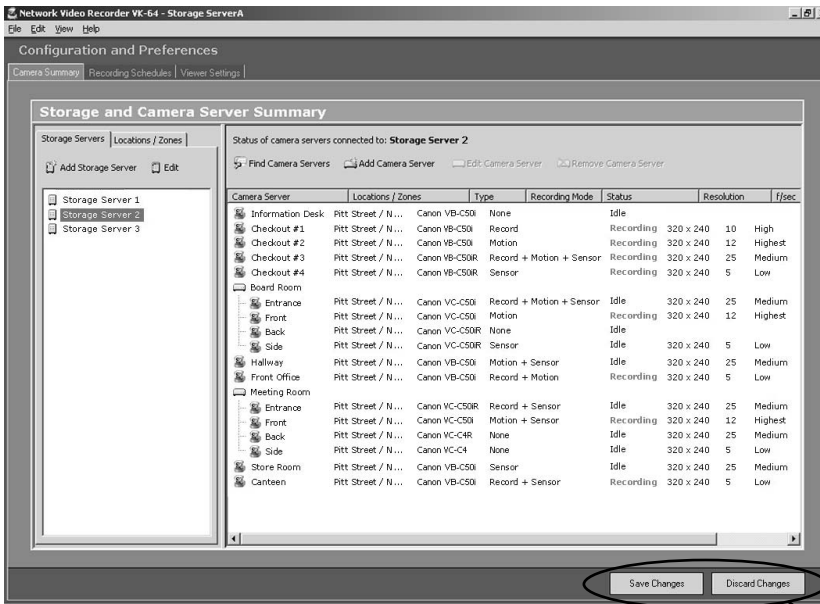

The bottom right-hand corner of the **Camera Summary** window consists of two buttons, **Save Changes** and **Discard Changes**.

Click **Discard Changes** to cancel any changes you have made.

Returning to the Viewer Screen

If you wish to return to the Viewer Screen, select **Viewer Screen** from the **View** menu bar.

Editing the Camera Server

The right-hand portion of the **Camera Summary** window features **Edit Camera Server** for Editing the Camera Server(s) on your system, regardless of which tab you have selected (**Storage Servers** or **Locations/Zones**). The same dialog as **Add Camera Server** (→ P. 87) opens.

Start Editing Camera Server

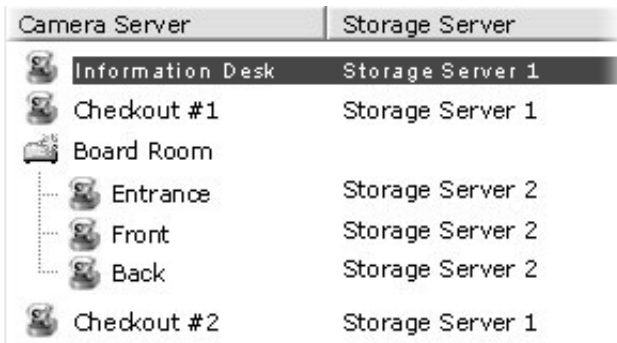

1 In the **Camera Server** list, click a Camera Server to highlight it.



2 Click **Edit Camera Server**. The **Edit Camera Server** dialog appears. This dialog is identical to the **Add Camera Server** dialog (you can also double-click an entry to bring up the dialog).

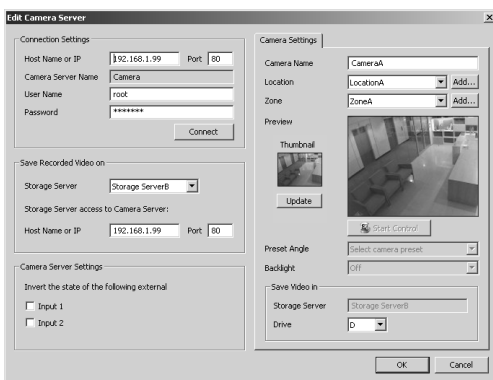

Change the Camera Server's Settings

Change the Camera Server settings as directed in P. 88 through P. 93.

● **Finish Editing**

Click **OK** when finished.

The **Camera Summary** window reappears.

● **Save Edit Contents**

To save edited Camera Server settings, click **Save Changes** at the bottom right-hand corner of the **Camera Summary** window.

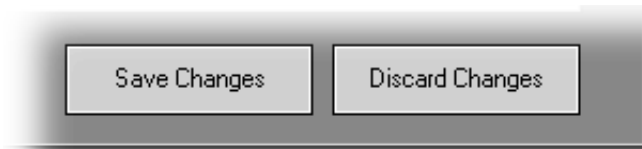

Click **Discard Changes** to cancel any modifications you have made.

Deleting the Camera Server

The right-hand portion of the **Camera Summary** window features **Remove Camera Server** for removing the Camera Server(s) from your system, regardless of which tab you have selected (**Storage Servers** or **Locations/Zones**).

Deleting the Camera Server

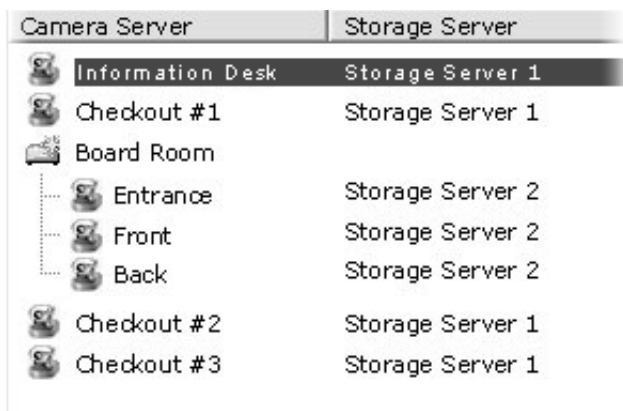

1 In the **Camera Server** list, click a Camera Server to highlight it.



2 Click **Remove Camera Server** (you can also press the **Delete** key on your keyboard).

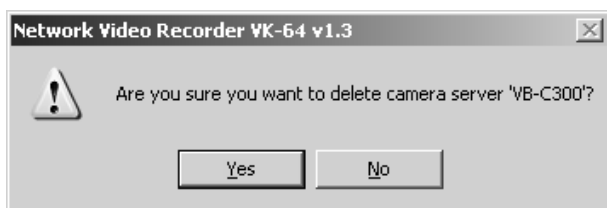

3 A confirmation dialog will appear. Click **Yes**.
Click **No** to cancel deletion.



Note

If a Camera Server is deleted, all the settings for VK-64/VK-16 associated with this Camera Server will be lost.

● Reflect Deletion

To reflect Camera Server deletion, click **Save Changes** at the bottom right-hand corner of the **Camera Summary** window.

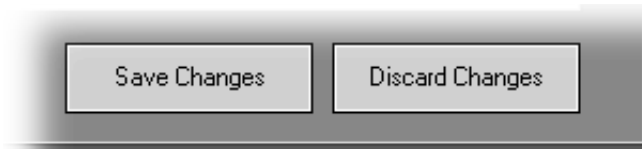

Click **Discard Changes** to cancel any modifications you have made.

Overview of Setting Recording Schedules

After you have registered the Camera Server, you can set the recording schedules.



Note

If you are using the Viewer only, you cannot set recording schedules.

You can start recording using a recording schedule by specifying “when” and “what” to record.

“When” - Select from the following:

- Specified day of the week (Normal Schedule)
- Specific day (Special Day Schedule)



Tip

- **Use a Normal Schedule for normal recording operation.**
- **Refer to P. 103 for how to use the Normal Schedule dialog.**
Example of Normal Schedule: Record video from 7:00 A.M. through 8:30 A.M. on every Wednesday and Friday.
- **Refer to P. 133 for how to use the Special Day Schedule dialog.**
Example of Special Day Schedule: Record video during the winter holidays from December 28 through January 3.

“What” - Select one or more from the following:

- Record video throughout the specified period of time (Continuous recording)
- Record video by Motion Detection during the specified time period (Motion Detection recording)
- Record video by sensor during the specified time period (Sensor Event recording)

The Motion Detection recording starts recording video when a motion has been detected. Refer to “Setting Motion Detection Recording” (→ P. 118) for details.

The Sensor Event recording starts recording video when a sensor input has occurred. Refer to “Setting Sensor Event Recording” (→ P. 125) for details.



Tip

One recording schedule can have Continuous, Motion Detection, and Sensor Event recording settings. You can record a Camera Server continuously at 1 frame per second and, for example, set recording to increase to 5 frames per second when motion occurs.

Recording Schedule

Two types of recording schedules are available: Normal Schedule and Special Day Schedule.

For both types of schedules, you must set the recording schedule for each Camera Server in the **Recording Schedules** screen.

● Display the Recording Schedules screen

- 1 Launch the VK Viewer and in the Menu Bar, select **View** → **Configuration**.
The **Configuration and Preferences** screen appears.
- 2 Click the **Recording Schedules** tab to display the **Recording Schedules** screen.
- 3 Click the **Normal Schedule** tab to display the **Normal Schedules** screen.



Recording Schedule

Day of the week

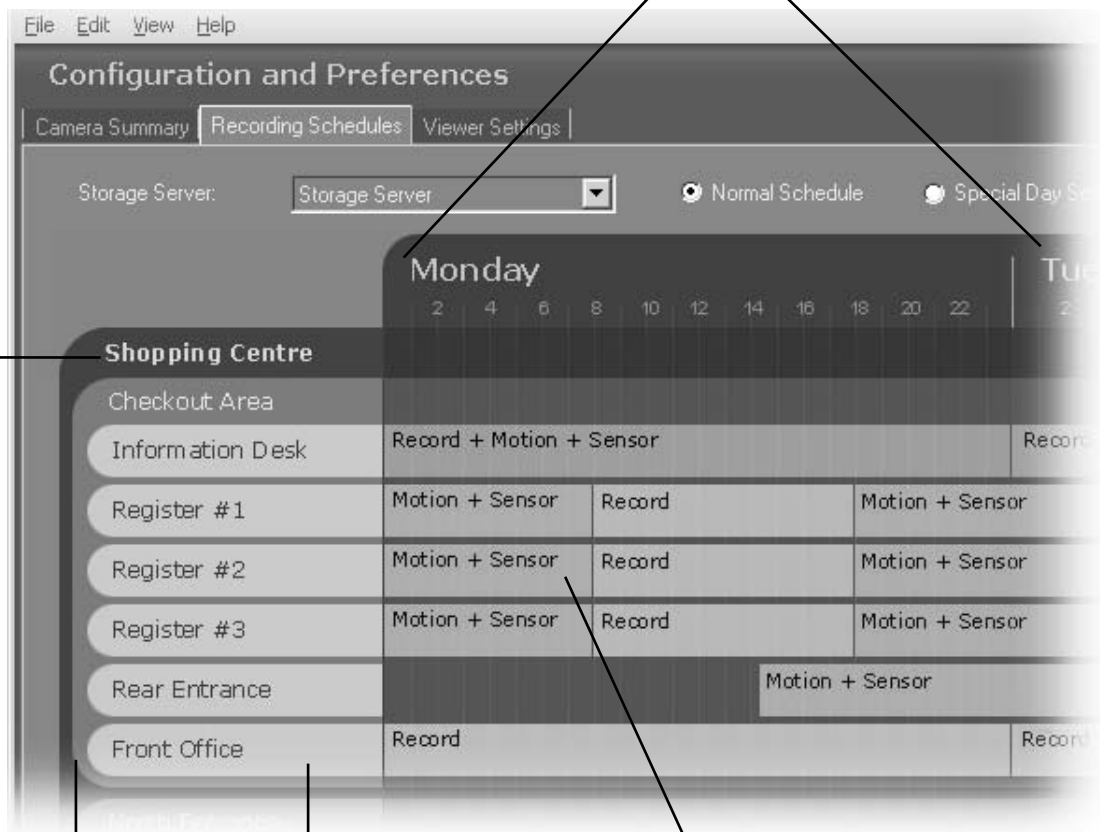

Shopping Centre

Checkout Area

Information Desk	Record + Motion + Sensor		Record
Register #1	Motion + Sensor	Record	Motion + Sensor
Register #2	Motion + Sensor	Record	Motion + Sensor
Register #3	Motion + Sensor	Record	Motion + Sensor
Rear Entrance			Motion + Sensor
Front Office	Record		Record

Location

Zone representing camera areas in the Location

Camera schedule time bars

Click and drag the horizontal scroll-bar to the right to view other schedule days.



Click and drag the vertical scroll-bar downward to view any other zones.



- 4 Click the Special Day Schedule tab to display the Special Day Schedule screen.

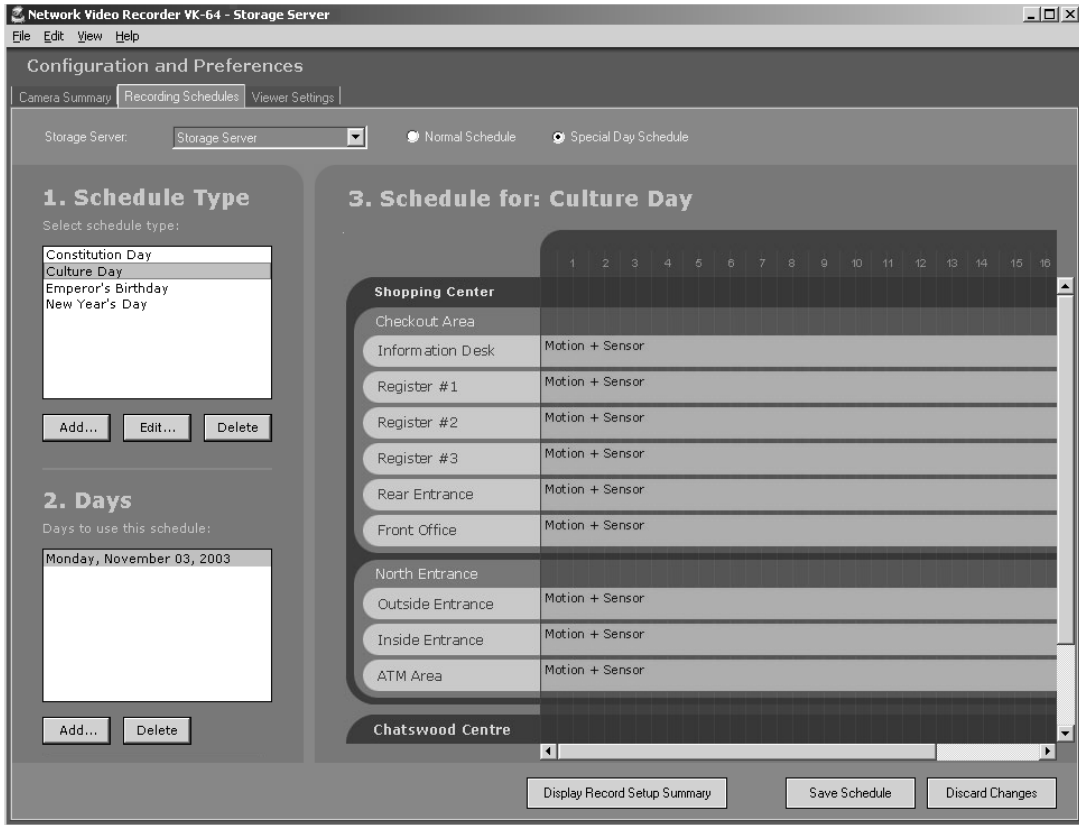

4

Registering Camera Server and Setting Recording Schedule

Recording Schedule

Storage Server selector

Single day schedule area (24 hours)

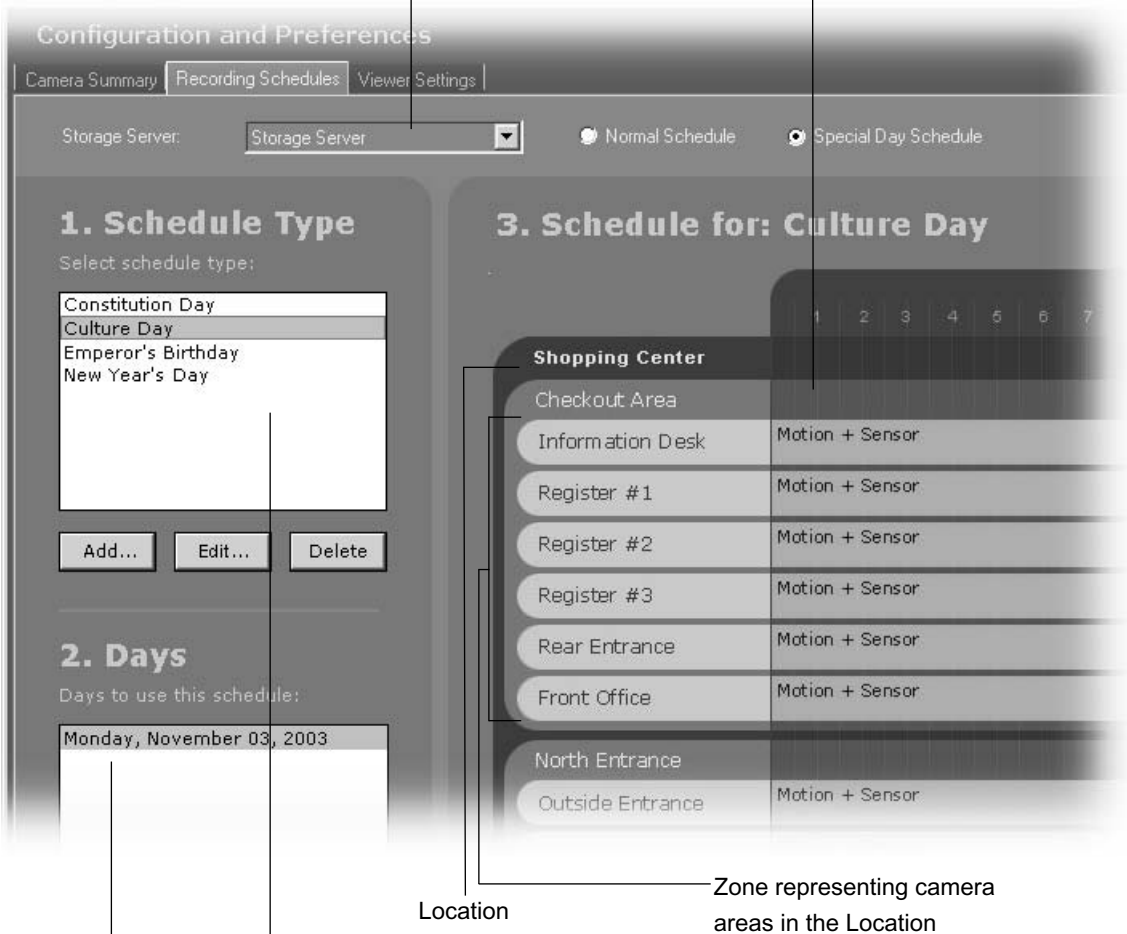

Day selector

Schedule Type selector

Location

Zone representing camera areas in the Location

Click and drag the scroll-bar(s) to view more schedules if necessary.

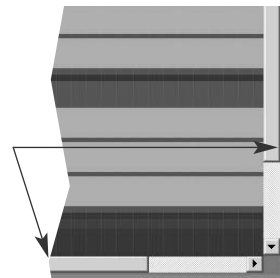

Note

- The scheduling area functions the same as the Normal Recording Schedule but only covers a single day (from 00:00 hrs. to 24:00 hrs). To have a special day schedule run over a long weekend (Fri, Sat & Sun), all dates of three days must be added to the list of days to use the schedule.
- When Special Day Schedules are running, Normal Schedules are disabled. If an invalid schedule exists, the following warning message will be displayed. "There is a camera with no recording schedule. Are you sure to save the settings?"

Configuring a Normal Schedule

The **Normal Schedule** consists of:

- **Storage Server list** - Select the Storage Server to edit the recording schedule.

When the **Recording Schedules** window is first opened, the first Storage Server in the list is shown with its associated schedule to the right.

- **Schedule Area** - Used to set up standard day-to-day recording settings of the system.

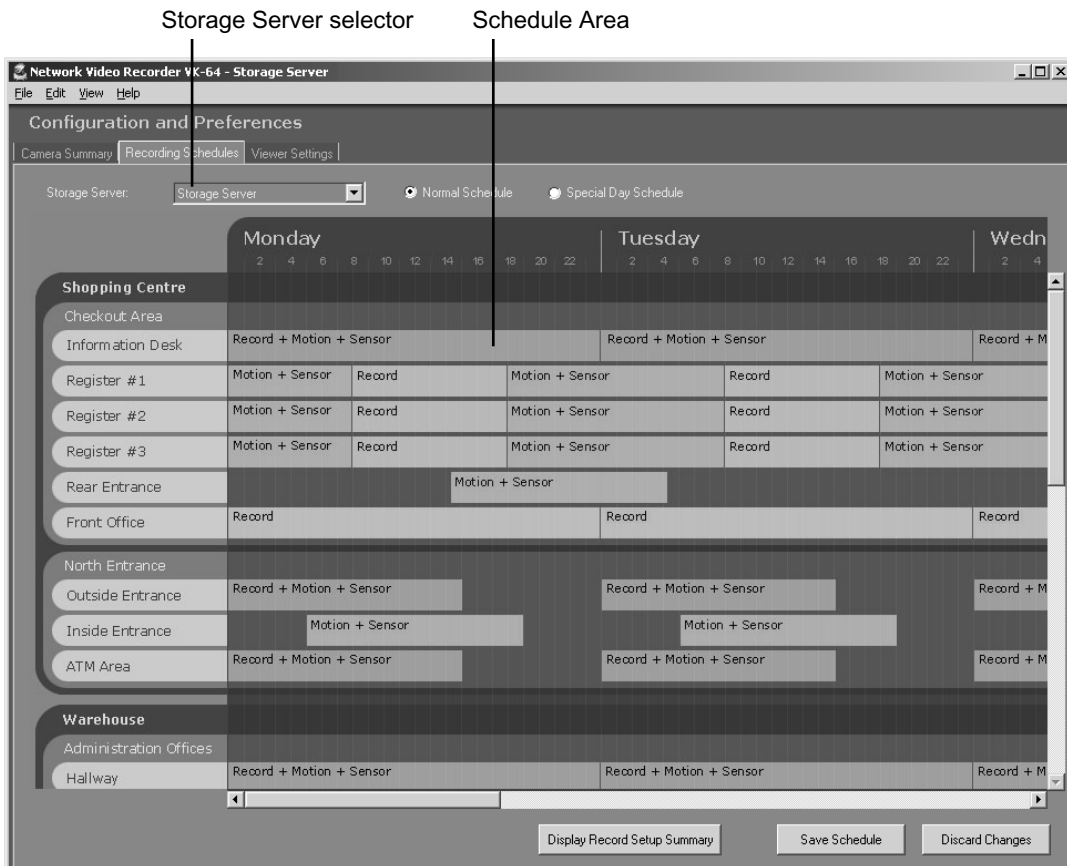

4

Creating a Normal Schedule

● Display the Recording Schedule screen

- 1 In the Menu Bar, select **View** → **Configuration**.
The **Configuration and Preferences** screen appears.
- 2 Click the **Recording Schedules** tab to display the **Recording Schedules** screen.
- 3 Click the **Normal Schedule** tab to display the **Normal Schedule** screen.

● Changing the Storage Server



If you wish to display another Storage Server's schedule, click the **Storage Server** menu, otherwise proceed to the next step.

The menu may list more assigned Storage Servers. If you select another Storage Server, the Schedule Area will refresh and associated schedule zones will be shown.

● Creating a Normal Schedule



Click and drag a time period for a camera name and release the mouse button. The **Add Schedule Item Camera** dialog is displayed.



Alternatively, right-click anywhere in the Schedule Area alongside a camera name and click **Add Schedule...** from the context menu.



You can also click and drag an area covering several cameras to bring up the **Add Schedule Item - multiple cameras** dialog. This allows you to easily set schedules for multiple cameras. Once created, settings for each camera can be customized.

Note

- The shortest recording time for a schedule is 15 minutes.
- You cannot create overlapping schedule items within a single Camera Sever.

Add Schedule Item - CameraA

Schedule

Start: 07:00 to End (Next Day): 01:50 All Day

Repeat on: M T W Th F S S

Recording Settings

Record: Continuously at Max. 5 fps

On motion detection Settings...

On sensor event Settings...

Preset: Custom Settings...

Preset Tour

Backlight: Not specified

Preview:

Control...
Setup...

Night Mode: Not specified

Resolution: Not specified

Option: Expose White Balance Focus

External Outputs

External Outputs Setting Setup...

OK Cancel

Set start and end times and the day of the week (→ P. 106).

Set frame rate, enable Motion Detection and sensor event recording (→ P. 107).

Set the preset camera angle and backlight compensation (→ P. 108).

Move the mouse cursor in the Preview area to change the camera angle (→ P. 91).

Control the camera via the **Camera Control Panel** (→ P. 185).

The Top page of the Camera Server is displayed after Internet Explorer launches.

Set the Night Mode, Resolution and Options (→ P. 109).

Set the external device output (→ P. 111).

* The number of external devices available for setting depends on the type of the Camera Server.

Configuration is discussed on the following pages.

Set the recording period

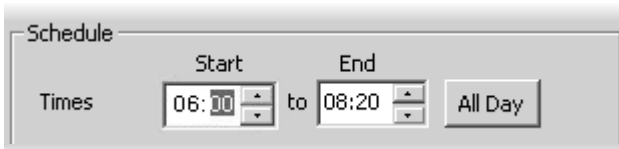

Schedule

Times Start End All Day

06:00 to 08:20

Click the hours or minutes fields to select, then click the up/down arrows or directly enter a value to change time.



Tip

- An example time period could be for overnight recording such as 'Start 22:00 to End 08:00'.
- Click All Day if you want 24 hour recording. The Start and End times will be set at 00:00 respectively.

Select a day of the week to record video



Repeat on M T W Th F S S

In the **Repeat on** area, check the days you wish to repeat the recording period you set in the **Times** area above.



Note

- If you have defined any special day schedules, such as public holidays, such schedules will override normal schedule times for the whole day.
- Times are given in 24 hours, for example 18:00 is 6:00 pm.
- If a Camera Server has been configured with Restrict Service Time, VK-64/VK-16 will not be able to record from the Camera Server during restricted times.
- The time zone used for the recording schedule will be the time of PC where the Storage Server is running.
- The Storage Server will adjust for Daylight Savings if configured in the operating system.

Set Continuous Recording



1 Click the **Continuously at Max.** box if you want to set continuous recording for the duration of the time period.

2 Select a frame rate for recorded video from the drop-down menu, or input a value from the keyboard.

You can set the frame rate from 0.1 frames per second to 30 frames per second. The default is 5 seconds.

Refer to P. 117 for details of Continuous Recording.

Configuring Motion Detection Recording Settings

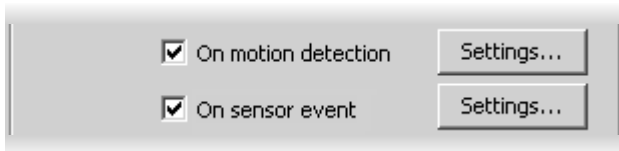

1 Click the **On motion detection** box if you want recording activated when motion is detected during this time period.

2 Click the **On sensor event** box if you want recording activated from a sensor during this time period.

3 Click **Settings...** to change the details.

Refer to P. 118 and P. 125 for details of Motion Detection and Sensor Event recordings.

Set the Preset Camera Angle and Backlight Compensation

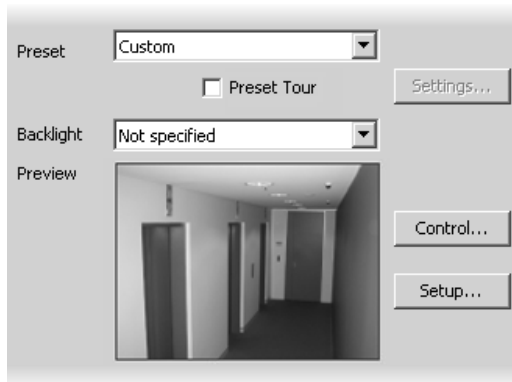

1 In the Preview field a live preview is given of the selected camera view when connected.

Select a Preset camera position from the drop-down menu of available camera angles, to retain a live preview from that angle.

Alternatively, move your mouse pointer in the Preview area to display controls and clicking to pan, tilt and zoom (→ P. 91).

2 Check **Preset Tour** to move among multiple preset positions sequentially (VB-C300, VB-C50i/VB-C50iR, VB-C50FSi, VB-C50Fi only). Click **Settings ...** to specify the order to switch among presets.

Refer to P. 132 for how to set the Preset Tour.

3 Select **On** or **Off** from the **Backlight** drop-down menu (You can set the backlight compensation to **High**, **Medium**, **Low** or **Off** for VB-C300, VB-C50i/VB-C50iR, VB-C50FSi and VB-C50Fi).

Selecting **Not Specified** accepts whatever backlighting the Camera Server offers.



Note

- **Preview area.** Camera angle can be changed by moving your mouse pointer in the Preview area to display controls. Click the controls to pan, tilt and zoom (→ P. 91).
- **After the camera has been controlled,** the preset will be set to **Custom**. The value this is set to will be the value used for recording and the position set will be the position recorded. If you set a preset position using the digital zoom of the VB-C300, the viewing angle may be misaligned.
- **If you select Not Specified** the Storage Server does not attempt to change the setting, rather it accepts whatever resolution/mode the Camera Server offers. If the camera angle is changed from the Viewer, the changed setting is used for recording.
- **In the following cases the Storage Server records whatever the Camera Server currently displays;**
 - Multiple number of cameras are connected to VB150 with the Video Input set to Single.
 - VB-C50i/VB-C50iR, VB-C50FSi, VB-C50Fi with an external camera connected and have configured the “Use External Video Input”.



Note

- During initializing the camera head position of VB-C50i/VB-C50iR, the camera head moves to face front, and then moves back to the current position. Please note that video will be recorded during this time.
- The On Motion Detection, Backlight compensation, and additional options are not available, if you use the Preset Tour function.
- If you change the Backlight Compensation setting and use the Camera Control Panel to do the pan, tilt, or zoom operation, the value in the Preset drop-down menu will changed to Record Current Position.
- Preset used for the Preset Tour are created on the Camera Server. Please refer to the Camera Server User's Manual for details on making camera presets.
- Although the VB-C300 does not allow Preset Tour on the Camera Server, the Preset Tour is available via this setting.
- If you are using a preset on the Camera Server, the Camera Server's preset takes precedence and the current position is changed to the preset position.
- If Continuous is set, the pre-event recording is not available.
- If Exposure is set, the Backlight compensation option is set to Not Specified.

Set the Night Mode and Resolution (VB-C300, VB-C50i/VB-C50iR, VB-C50FSi, VB-C50Fi and VB150)

1

Select the **Night Mode** from the drop-down menu. You can select from **Not Specified**, **Disabled**, **Enable**, and **Auto**.



Note

- If you select Enabled, the Night Mode status will be changed to Disabled after the configured recording schedule finishes.
- A higher resolution results in larger disk usage. Make sure you have enough disk space.
- If you set Night Mode to "Auto", please make sure that Exposure mode is set to "Auto" on the Camera Control Panel.
- You can select from Not Specified, Disable, Enable, and Auto (for VB-C300 only) for VB-C300, VB-C50i series, and VB150.
- Video turns to monochrome in the Night Mode.
- If you specify Auto, you cannot control the Night Mode using the Camera Control Panel.
- You cannot use the built-in infrared lamp if you are using the optional dome housing.



Tip

- In the Night Mode, the IR cut filter is disabled and the camera acts as an IR camera. After the schedule expires, the Night Mode will be disabled.
- Day Mode activates the Camera Server's IR cut filter to reflect the infrared ray and pass the visible rays.

2

Select a **resolution** for recording from the drop-down list. You can select from **Low**, **Medium**, **High** or **Not specified**.

If you select **Not specified**, the Storage Server does not attempt to change the setting, rather it accepts whatever Night Mode setting and resolution the Camera Server offers.



Tip

Correspondence between the specified resolution and actual resolution is shown below.

Small Size	160 x 120 (NTSC) 192 x 144 (PAL_ VB-C50i series)
Medium Size	320 x 240 (NTSC) 192 x 144 (PAL_ VB-C50i series)
Large Size	640 x 240 (NTSC_ VB101/VB150) 640 x 480 (NTSC_ VB-C10/VB-C50i series/VB-C300) 768 x 576 (PAL_ VB-C50i series)

Set Additional Options



To use the exposure, white balance, and/or focus settings on the **Camera Control Panel**, check the corresponding check box.



Note

- The additional option is only allows to use with VB-C300. Other models cannot use these options.
- If the Exposure box is checked, the Backlight compensation option will be disabled.
- If the Preset Tour is enabled, you cannot use additional options.
- The additional option settings will be return to the original settings if the Camera Server settings are changed during schedule execution.

● Set External Device Output

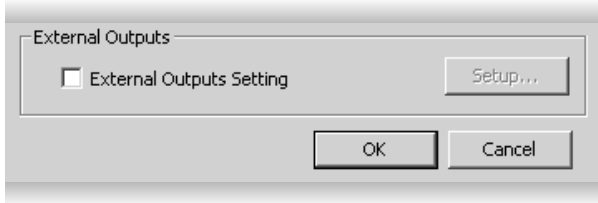

1 Click **External Outputs Setting** to control any external devices that may be connected to your Camera Server.

2 Click **Setup...** to change the details of external outputs. If you do not change the settings, the defaults will be used.

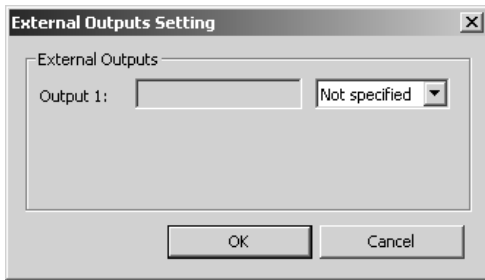

3 If **Setup...** is clicked, click the drop-down menu for the target external device and set **External Outputs** to **On** or **Not specified** on the External Outputs Setting dialog.



Note

For the VB-C300, only one external device can be configured on the External Outputs Settings dialog.

● Finish Setting

Click **OK** to save the new settings and close the dialog.

Click **Cancel** to discard the new settings.

When you click **OK**, the Preset and Backlight settings are effective on Video Windows in the Viewer. Control the camera as required by clicking **Camera Control**.

● Save Schedules

- 1 To save the Normal Schedule, click **Save Schedule** at the bottom right-hand corner of the **Normal Schedule** window.

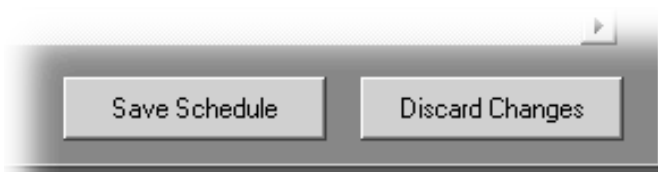

Click **Discard Changes** to cancel any modifications you have made.

- 2 If you wish to return to the Viewer, select **Viewer Screen** from the **View** menu bar.



Note

Camera Servers have certain features to allow image capture operations based on sensor input or schedule. If settings are enabled on the Camera Server, they take precedence over any settings made in VK-64/VK-16. This may cause some confusion if your VK-64/VK-16 recording schedules fail to record with the correct camera preset. You should disable such Camera Server features if you wish VK-64/VK-16 settings to take precedence.

Changing the Camera Server Settings

The Top page of the Camera Server is displayed after Internet Explorer launches (VB-C50i).



Click **Setting Page** to display the Settings Page to change the Camera Server settings.

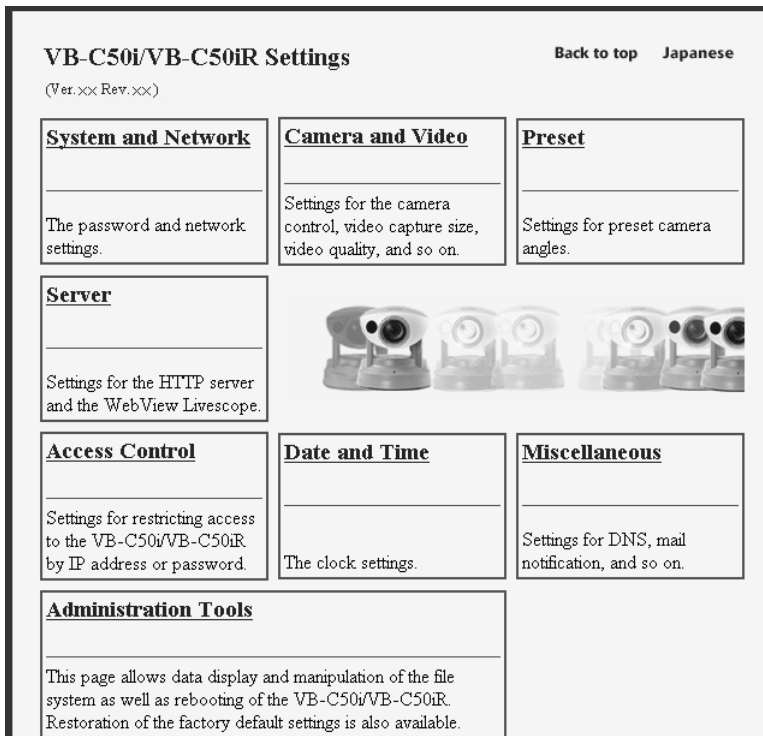

Items related to recording schedule setting are as follows. Refer to the Camera Server manual for details.

User Name and Password

- Set the user name and password for the Camera Server. You cannot set them with the VK-64/VK-16.

Motion detection recording

- If the Camera Server is the VB-C50i/VB-C50iR, VB-C50FSi, VB-C50Fi, or VB150, you can configure the Motion Detection settings on the Camera Server.
- To configure the Motion Detection settings on the VB-C50i/VB-C50iR, VB-C50FSi, VB-C50Fi, or VB150, you must install the VB Administration Tools supplied with the Camera Server in advance. You can set up to four Motion Detection areas. Be sure to set a recording schedule to execute the specified Motion Detection recording using the Schedule Setting Tool.
- For a VB150 (“Video Input” must be set to “Single”), the Motion Detection settings are configured using the normal VK-64/VK-16 Motion Detection Settings dialog (→ P. 119).
- If the Motion Detection settings are configured on the Storage Server, the load on the CPU may go high depending on the detection settings and the number of Camera Servers, and affect the recording. We recommend that you configure the Motion Detection setting at the Camera Server.

Quality

- You can set the video quality. The Motion Detection settings are affected by the video quality setting of the Camera Server. After configuring the Motion Detection settings, do not change the video quality on the Camera Server.

Camera Name

- Set the name of the camera displayed in the Camera Server list. You cannot set them with the VK-64/VK-16.

Preset

- Presets must be set on the Camera Server in advance. You cannot set them with the VK-64/VK-16.
- If the recording settings using a preset are used on the Camera Server, the preset position will override camera positions set by VK-64/VK-16, including those in recording schedules and Camera Server position. If VK-64/VK-16 has camera control, this will be lost when the Camera Server is setting a new preset position.
- If predefined presets are not shown in the **Preset** drop-down menu even if they have been defined on the Camera Server, click **Camera Control** to display the Camera Control Panel, obtain camera control, then configure the settings again.

Restrict Service Time

- If a Camera Server has been configured with **Restrict Service Time**, VK-64/VK-16 will not be able to record from the Camera Server during restricted times.

External Device

- Specify the name of the external device, such as sensor name. You cannot set it with the VK-64/VK-16.
- If the external device is not set on the Camera Server, the VK-64/VK-16 cannot set it.

Sensor Input, Recording to Camera Memory

- Camera Servers have certain features to capture image into its memory based on sensor input or schedule. If settings are enabled on the Camera Server, they take precedence over any settings made in VK-64/VK-16. This may cause some confusion if your VK-64/VK-16 recording schedules fail to record with the correct camera preset. You should disable such Camera Server features if you wish VK-64/VK-16 settings to take precedence.

Batch-Setting Schedules

You can set multiple schedules at once.

● Create Multiple Camera Schedules

You can also click and drag an area covering several cameras to bring up the **Add Schedule Item - multiple cameras** dialog. This allows you to easily set recording schedules for multiple cameras. Once created, settings for each camera can be customized.



Example : Drag over the Schedule area covering three Camera Servers to set the same schedule for the three Camera Servers.

● Change or Move Multiple Camera Server Schedules

While holding down the **Ctrl** key, click on individual schedule items to select them, and drag the mouse to change or move multiple recording schedules.



Setting Continuous Recording

You can set Continuous recording with the frame rate of 0.1 frames per second to 30 frames per second when creating a Normal Schedule or Special Day Schedule.

Specify the number of still images to record every second.

Higher fps value generates smooth video, however, the load on the Storage Server or network goes higher. Video data quantity also increases to consume hard disk space.

To configure the Camera Server for recording:

Set Recording Mode

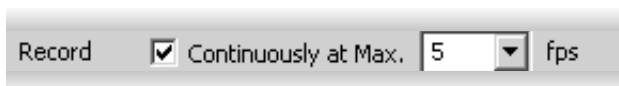

1 Click the **Continuously at Max.** box if you want to set continuous recording for the duration of the time period.

2 Select a frame rate for recorded video from the drop-down menu, or input a value from the keyboard.

You can set the frame rate from 0.1 frames per second to 30 frames per second. The default is 5 seconds.



Note

- When the load on Storage Server CPU and hard disk is high, recording at the specified frame rate may not be available, or the video recording may be interrupted.
- Higher frame rates for result in larger disk usage. Make sure you have enough disk space.
- The frame rate specified is the frame rate that the Storage Server will attempt to record, and may not be the actual frame rate used for recording video. Factors such as the number of Viewers, load on the Camera Server and the Storage Server, and network traffic may reduce the actual frame rate recorded. Also, the maximum frame rate for a VB-C10 configured with a resolution of 640 x 480 is 10 frames per second, and for a VB150 with 4 cameras is 2-3 frames per second.

Setting Motion Detection Recording

Configuring Motion Detection Recording Settings

The Motion Detection recording starts recording video when a motion has been detected.

Configure the Motion Detection recording settings in the **Motion Detection Settings** window which appears when you click **Settings**.

Some items in the **Motion Detection Settings** window overlap with the items in the **Add/Edit Schedule Item** dialog. In Motion Detection recording, the settings in the **Motion Detection Settings** window take precedence. **Preset** and **Backlight** settings in the **Add/Edit Schedule** dialog are applied to the Motion Detection recording.



Note

- The Motion Detection settings are affected by the video quality setting of the Camera Server. After configuring the Motion Detection settings, do not change the video quality on the Camera Server.
- Motion detection is done by the Storage Server or Camera Server (whichever selected in the Motion Detection Settings window). If the Camera Server executes motion detection, motion detection is not available while the Camera Server is performing the pan, tilt, or zoom operation (motion detection by the Storage Server is available during these operations).
- If the recording schedule expires during Motion Detection recording, the Motion Detection recording also terminates.

Editing Motion Detection Recording Settings

You can specify the detection area and the amount of sensitivity for Motion Detection Recording. The area for detection can also be modified which is ideal, for example, if the field of view has two entrances and you wish to monitor motion for one entrance.

Step 1: Next to On Motion Detection, click Settings...

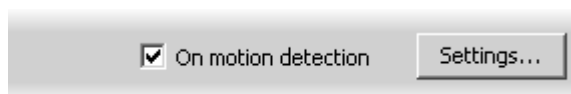

The **Motion Detection Settings** dialog opens (The dialog for VB-C300 is shown below).

Click to activate Motion Detection on the Camera Server for VB-C50i/VB-C50iR, VB-C50FSi and VB-C50Fi.

Set a priority for events triggered by motion.

Select sensitivity options.

Click and drag a control point to re-size the active region.

Motion detection level indicator will increase during activity.

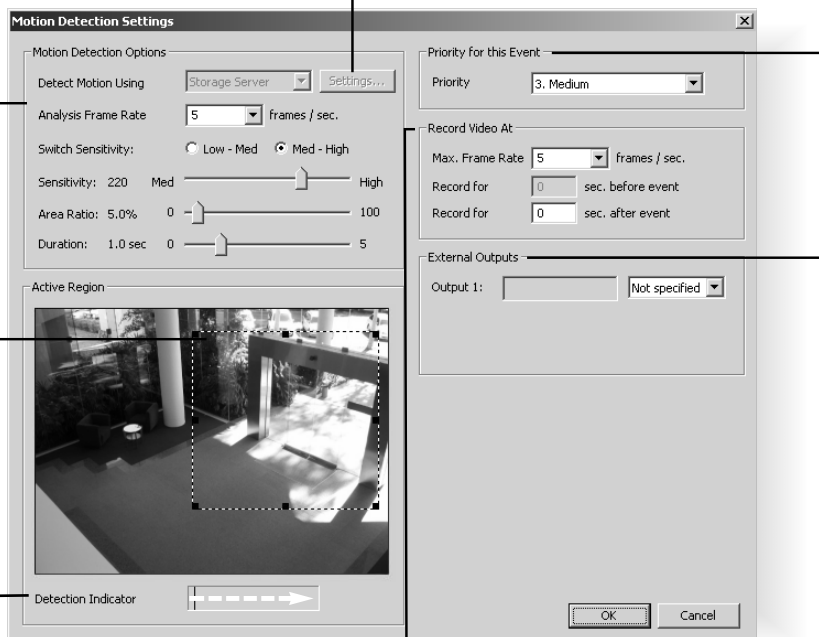

Select frame rate and pre/post event duration for recording triggered by motion.

Activate external device output.



Note

- If the Sensor Event recording is also enabled and motion detection and sensor input occur simultaneously, the Sensor Event recording takes precedence. Refer to “Priorities of Motion Detection and Sensor Event Recording” (→P. 131) for details.
- You cannot use the Preset Tour and the Motion Detection recording together.
- Certain Camera Servers have certain features to allow image capture operations based on sensor input or schedule. If settings are enabled on the Camera Server, they take precedence over any settings made in VK-64/VK-16, and your VK-64/VK-16 recording schedules fail to record with the correct camera preset. You should disable such Camera Server features when using VK-64/VK-16 to record images.

Step 2: Set the active region for recording



In the **Active Region** field, adjust the region where motion detection is triggered. By default, the **Active Region** is the full area. You cannot use pan, tilt, and zoom operations in this window.

- 1 Click one of the corner or edge handles and hold down the mouse button.
- 2 Drag the handle to change the motion-trigger boundary (dotted frame); click the corners to adjust the area or click the edge handles to bring each side in or out respectively.

Step 3: Set Motion Detection Options

Set the following options on the **Motion Detection Settings** dialog.

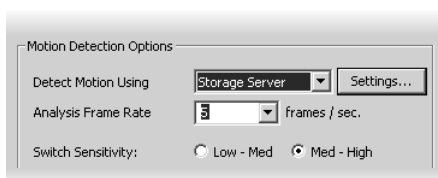

- 1 In the **Detect Motion Using** menu, select one of the following:

Storage Server

Obtains video from the Camera Server and detects motion with the Storage Server.

Camera Server

Uses the Motion Detection function of the Camera Server to detect motion (This menu is only active for VB150 servers with the Video Input set to Single or VB-C50i/VB-C50iR, VB-C50FSi, VB-C50Fi).

- 2 In the Analysis **Frame Rate** menu, select from 0.1 to 30 frames per second.

If you select the **Camera Server** to detect motion, **Settings...** becomes available. **Settings...** is now enabled. Click to launch your VB Admin Motion Detection Setting Tool. You must have VB Admin Tools installed in advance. Refer to the Camera Server's User's Manual for how to configure the motion detection settings.



Note

- To use the Motion Detection function of the VB-C50i/VB-C50iR, VB-C50FSi and VB-C50Fi, it is necessary to configure schedules from the "VB Admin Schedule Setting Tool".
- Setting motion detection at the Storage Server causes high CPU load. It is strongly recommended to set motion detection at the Camera Server whenever it has the motion detection function.

The **Motion Detection Options** field also allows you to set the sensitivity for Motion Detection within the **Active Region**.

Motion detection status is shown by the **Detection Indicator** during operation.

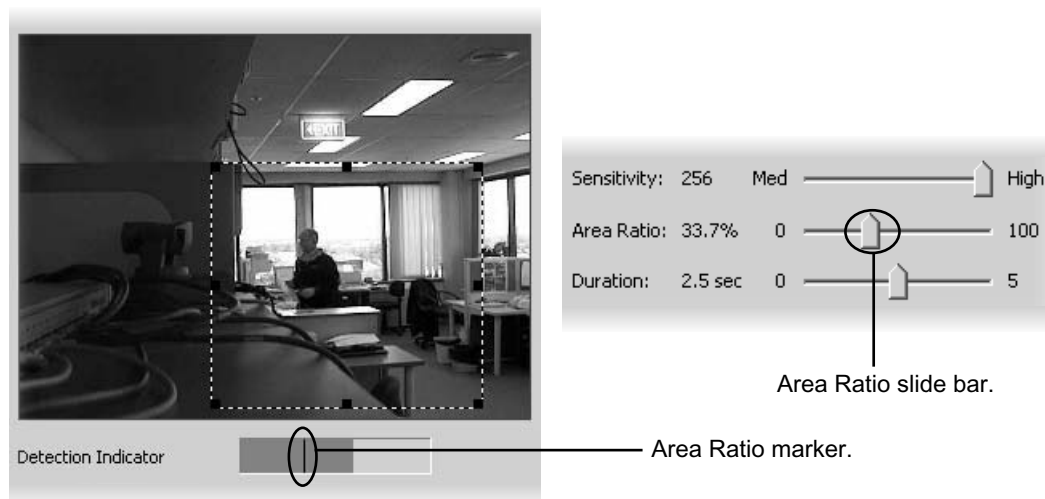

Detection Indicator Colors

Motion is displayed in the **Detection Indicator** as a green color bar and will remain green if the level of motion is below the set Sensitivity and within a defined Area Ratio. If motion reaches the set **Sensitivity** and **Area Ratio**, the color bar changes to yellow and if the detected motion remains at the yellow level for the defined duration, a red color bar is displayed and an event is triggered. The behavior of the **Detection Indicator** is described as follows.

- 

Area Ratio marker.

● Green color bar - The area of change that is less than the specified **Area Ratio**, i.e., activity remains at the left of the Area Ratio marker.
- 

Area Ratio marker.

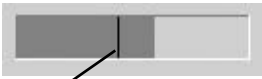
● Yellow color bar - The area of change that is equal to or greater than the specified **Area Ratio** (activity peaks on or to the right of the Area Ratio Marker) but the required amount of motion has not met the specified duration in order to trigger an event.
- 

Area Ratio marker.

● Red color bar - The amount of change that meets the defined detection conditions and motion is detected, triggering an event, i.e., the required amount of motion has been detected for the specified duration.

● Set the Sensitivity

Sensitivity is the degree of change detected as motion.



1 Select **Low-Med** or **Med-High**. The available sensitivity settings range from 1 to 256.

You can specify 1 through 128 as Sensitivity by clicking **Low-Med** and 129 through 256 by clicking **Med-High**.

2 Drag the slide bar to adjust **Sensitivity** to the desired value (depending on the range setting).



Note

The Motion Detection settings are affected by the video quality setting of the Camera Server. After configuring the Motion Detection settings, do not change the video quality on the Camera Server.

● Set the Area Ratio

Area Ratio is the degree of change of area (ratio against the defined detection area) detected as motion.

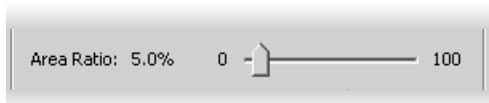

Click and drag the **Area Ratio** slide bar to any position from 0% to 100%. This establishes the proportion of image inside the Active Region (dotted frame) allowed before motion is detected.

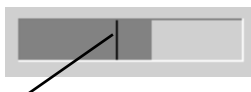

Area Ratio marker.

When you drag the slide bar, the black vertical line in the Detection Indicator will move to reflect the change in specified **Area Ratio**.

Set the Duration

Duration is the length of time necessary for the change to be recognized as motion.



Click and drag the **Duration** slide bar to any position between 0.0 and 5.0 seconds. This establishes the duration of motion allowed before an event is triggered. It also establishes the period where there is no motion in order for the event to be completed.

Step 4: Set the event priority status

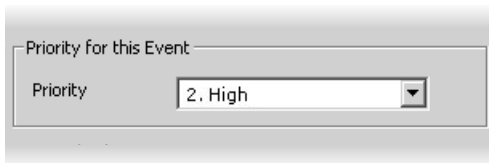

In the **Priority** field, select the priority for the event to be generated for this motion from a menu of five options, ranging from **1. Highest** to **5. Lowest**. Priorities are color-coded in the Timeline in the Viewing Screen.

Step 5: Set frame rate and pre and post event recording duration

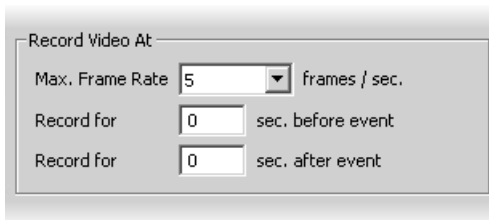

1 Max. Frame Rate - select a maximum frame rate for recorded video from the drop-down menu. Choose from 0.1 frames per second to 30 frames per second (5 is the default).

2 Record for before event - enter a number of seconds for the amount of recording time before the event occurs (up to 30 seconds).

 **Note**

- If **Continuous** is also set, **Record for before event** is not available.
- If **Record for before event** is set to one second or longer, it will take approximately 10 seconds after event occurrence until its display.

3 Record for after event - enter a number of seconds for the amount of recording time after the event occurs (up to 999 seconds).

Step 6: Set the External Outputs

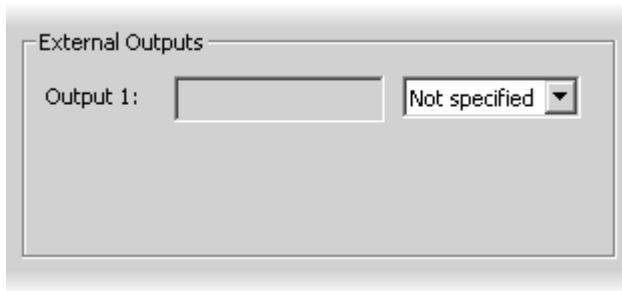

Click the drop-down menu for the target external device and set **On** or **Not specified**.



Note

- Available external outputs depend on the Camera Server.
- If the Picture Recording feature of a Camera Server is used and its configuration includes a preset position then this preset position will override camera positions set by VK-64/VK-16, including those in recording schedules and the Viewing Screen. If VK-64/VK-16 has camera control, this will be lost when the Camera Server is setting a new preset position.

Click **OK** to save the new settings and close the dialog.

Click **Cancel** to discard the new settings.



Note

If the before event and after event fields are set to 0 seconds, video will still be recorded while motion is detected.



Tip

Refer to the Chapter 6 for optimizing the Motion Detection operation.

Setting Sensor Event Recording

Configuring Sensor Event Recording Settings

The Sensor Event recording starts recording video when a sensor input has occurred.

Configure the Sensor Event recording settings in the **Sensor Event Settings** window which appears when you click **Settings**.

Some items in the **Sensor Event Settings** window overlap with the items in the **Add/Edit Schedule Item** dialog. When the Sensor Event recording is executed, the settings in the **Sensor Event Settings** window take precedence.



Note

If the recording schedule expires during Sensor Event recording, the Sensor Event recording also terminates.



Tip

If using a VB150 with multiple cameras and “Video Input” is also specified, you can configure different Sensor Event recording settings for each camera (or you can specify “Do not record”).

Editing Sensor Event Recording Settings

You can specify recording settings based on the occurrence of a sensor event. A number of tabs in the **Sensor Event Settings** dialog are shown to reflect the number of sensors on each camera. You can modify the recording settings for each sensor.

Step 1: Next to On sensor event, click Settings...

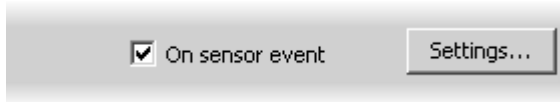

The **Sensor Event Settings** dialog opens.

Click a tab to modify that sensor's settings. The sensor name displayed is the name set by the Camera Server.

Night Mode is available for VB-C300, VB-C50i/VB-C50iR, VB-C50FSi and VB-C50Fi Camera Servers or VC-C50i/VC-C50iR cameras connected to Camera Server VB150s. Click Night mode and select **Disabled**, **Enabled**, IR light off or Enabled, **IR light on** from the sub-menu.

You can set **External Outputs** to **On** or **Not specified** when a sensor event occurs.

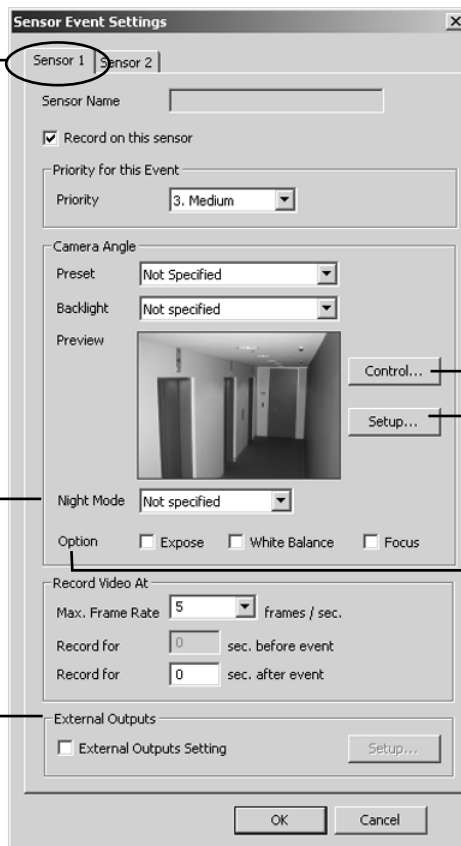

Control the camera via the **Camera Control Panel**. Refer to the Viewer Manual for the information about the Camera Control Panel.

The Top page of the Camera Server is displayed after Internet Explorer launches.

Set whether or not to use additional options (exposure, white balance, and focus).



Note

- Frequent sensor events result in high CPU load on the Storage Server. If you have 10 or more sensor events per minute continuously, we recommend continuous recording.
- Setting Night Mode to Enabled will activate the IR cut filter. It will not turn on the built-in IR light. To turn on the IR light, perform the operation from the Video Window menu.

Step 2: Enable recording and set an event priority

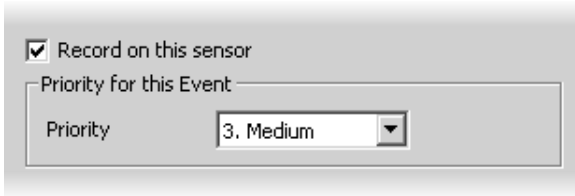

- 1 Check **Record on this sensor** to enable recording when a sensor is triggered.
- 2 In the **Priority** field, select the priority for the event to be generated for this motion from a menu of five options, ranging from **1. Highest** to **5. Lowest**. Priorities are color-coded as events in the Timeline in the Viewing Screen.

Step 3: Specify a camera angle when the sensor is triggered

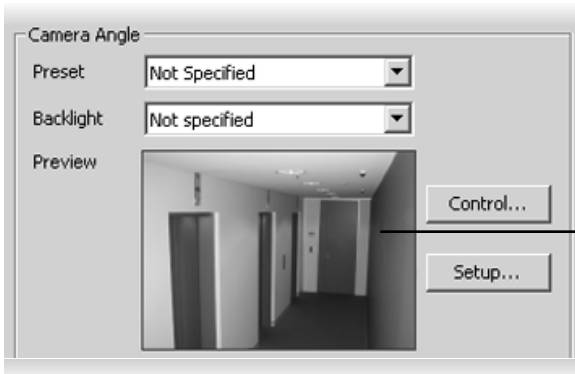

In **Camera Angle**, select a preset camera angle from the **Preset** drop-down menu. When the sensor is triggered, the camera will be changed to this position. If you select **Not Specified**, the camera will not be moved.

The camera angle can also be changed by moving your mouse pointer in the **Preview** area to display controls and clicking to pan, tilt and zoom (→ P. 91). After the camera has been controlled, the **Preset** will be set to **Custom**.



Note

If you set a preset position using the digital zoom of the VB-C300, the viewing angle may be misaligned.



Tip

- Click the **Backlight** drop-down menu and select **On** to compensate for camera views with strong backlighting. The setting will be used when the sensor is triggered. This is useful, for example, if a camera angle would change from an indoor view to an outdoor view when the sensor is triggered.
- If you set the **Preset** option in the Sensor Event Settings window, the pre-event recording position may be different from the specified position because the Camera Server moves when a sensor input occurs. Also, if you specify the post-event recording time to “0”, and the sensor input occurs for a short period of time, recording may terminate before the Camera Server reaches the preset position (If the sensor input is momentary, the Camera Server may not even move).
- If you are using a normal close type sensor, you need to set the presets with the Camera Server recording screen. Refer to “Configure External Device Input” (→ P. 89) for the details.

Step 4: Set the Night Mode (VB-C300, VB-C50i/VB-C50iR, VB-C50FSi, and VB-C50Fi)

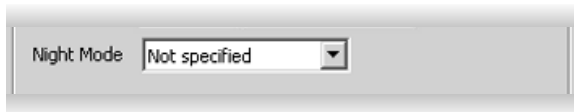

Select the **Night Mode** from the drop-down menu. You can select from **Disabled**, **Enabled**, or **Not specified**.

Step 5: Set Additional Options (VB-C300)



To use the exposure, white balance, and/or focus settings on the **Camera Control Panel**, check the corresponding check box.



Note

- **VB-C300 only allows these options to be used.**
- **If Exposure is set, the Backlight compensation option is set to Not Specified.**

Step 6: Set frame rate and pre and post event recording duration

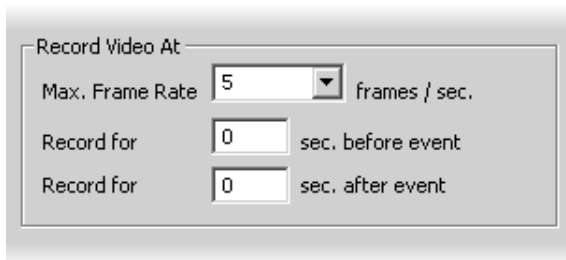

In the **Record Video At** field:

1

Max. Frame Rate - select a maximum frame rate for recorded video from the drop-down menu, or enter a value from the keyboard. Choose from 0.1 to 30 frames per second (5 is the default).



Note

The frame rate specified is the frame rate that the **Storage Server** will attempt to record, and may not be the actual frame rate used for recording video. Factors such as the number of **Viewers**, the number of **Camera Servers** used, network traffic and load on the **Camera Server** and the **Storage Server** may reduce the actual frame rate recorded.

2 **Record for before event** - enter a number of seconds for the amount of recording time before the event occurs (up to a maximum of 30 seconds).



Note

- If **Continuous Recording** is also set, **Record for before event** is not available.
- If **Record for before event** is set to one second or longer, it may take approximately 10 seconds after event occurrence until its display.

3 **Record for after event** - enter a number of seconds for the amount of recording time after the event has transpired (up to a maximum of 999 seconds).

Click **OK** to save the new settings and close the dialog.

Click **Cancel** to discard the new settings.



Note

- If the **before** and **after event** fields are set to 0 seconds, video will still be recorded while the sensor is activated.
- Longer pre-event recording will increase memory usage. Longer pre-event recording with insufficient memory may greatly reduce performance when the disk-based virtual memory runs short.
- Even when **Record for after event** is enabled, the frame rate, frame size and network delays may have an effect on when the last frame is recorded and thus the full requested duration of post event recording may not be available.

Step 7: Set the External Outputs

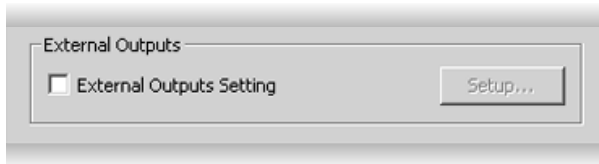

1 Click **External Outputs Setting** to control any external devices that may be connected to your Camera Server.

2 Click **Setup...** to change the details of external outputs. Otherwise the default settings will be used.

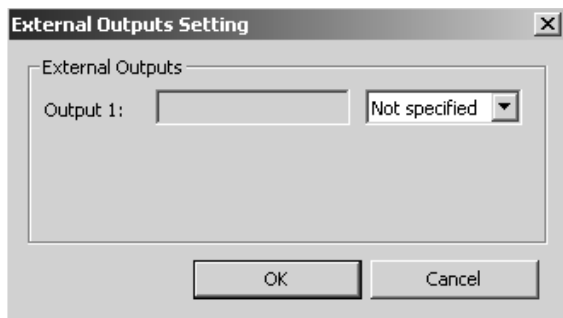

3 If **Setup...** is clicked, click the drop-down menu for the target external device and set **External Outputs** to **On** or **Not specified** on the **Control External Devices** dialog.



Note

- Available external outputs depend on the Camera Server.
- Higher frame rates for Record Video At result in larger disk usage. Make sure you have enough disk space.
- Camera Servers have certain features to allow image capture operations based on sensor input or schedule. If settings are enabled on the Camera Server, they take precedence over any settings made in VK-64/VK-16. This may cause some confusion if your VK-64/VK-16 recording schedules fail to record with the correct camera preset. You should disable such Camera Server features if you wish VK-64/VK-16 settings to take precedence.

Priorities of Motion Detection and Sensor Event Recordings

You can specify events priorities for the Motion Detection and Sensor Event recordings, and if the events occur simultaneously, the recording with the higher priority is performed first.

When using the Motion Detection and Sensor Event recordings together and motion detection and sensor input occur simultaneously, the Sensor Event recording takes precedence.

If two events with the same priority occur, the later event takes precedence. When the later event terminates and the former event still remains, the former event will be handled.

Example: When Event A occurs with Sensor #1 and Event B occurs with Sensor #2

1. If the former event terminates before the later event:

(Assuming that the time for both events is two units)

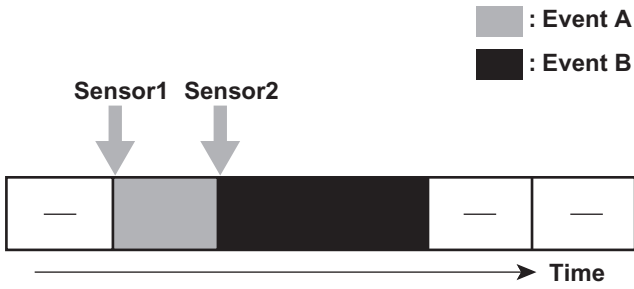

2. If the former event terminates after the later event:

(Assuming that the time for Event A is four units and the time for Event B is two units)

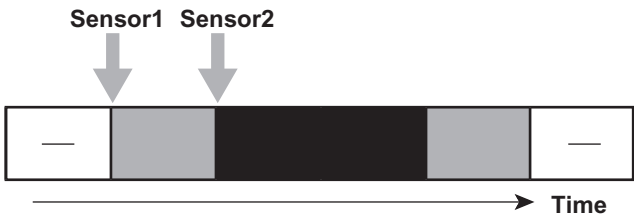

Setting the Preset Tour

Use the Preset Tour function to move among multiple preset positions sequentially.

In the **Add/Edit Schedule Item** dialog, there are two options available for setting the Preset Tour function. To set the Preset Tour function.



Note

- The durability of camera Pan/Tilt mechanism may be affected depending on the Preset Tour setting (→ P. 135).
- In the Preset Tour, the camera position returns to the first preset after the last preset.
- When the Preset Tour is used, the Motion Detection recording, backlight compensation, and additional options are not available.
- Presets used for Preset Tour are created on the Camera Server.
Please refer to the Camera Server's User's Manual for details on creating camera presets.
- Preset Tour can be used with VB-C300, VB-C50, and VB-C50iR only.

Setting Presets

Add a Preset

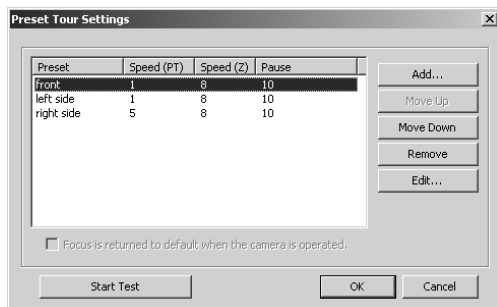

1

Check the **Preset Tour** box and click **Settings....**

The **Preset Tour Settings** dialog is displayed.

2

Click **Add**.

The **Preset Tour (Add)** dialog appears.

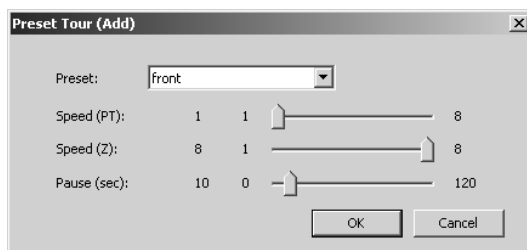

3

Select a preset to add from the **Preset** drop-down menu.

4

For the selected preset, configure the **Speed (PT)**, **Speed (Z)**, and **Pause (sec)** settings.

Drag the slide bar for each item to set the value.

- 5 Check the settings and click **OK**.
This returns to the **Preset Tour Settings** dialog.

Test the Preset Tour

- 1 Check the **Preset Tour** box and click **Settings....**
The **Preset Tour Settings** dialog is displayed.
- 2 Click **Start Test**.
Clicking **Start Test** executes the Preset Tour once and you can check the operation.

Change the Preset Settings

- 1 Check the **Preset Tour** box and click **Settings....**
The **Preset Tour Settings** dialog is displayed.

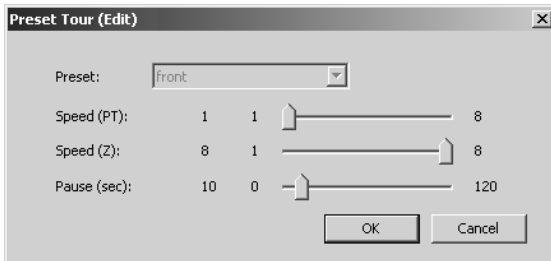

- 2 Select a preset to change from the list and click **Edit**.

The **Preset Tour (Edit)** dialog appears.

- 3 For the selected preset, change the **Speed (PT)**, **Speed (Z)**, or **Pause (sec)** settings.

Drag the slide bar for each item to set the value.

- 4 Check the settings and click **OK**.
This returns to the **Preset Tour Settings** dialog.



Tip

For VB-C300, you can return the focus to the default setting by checking the Focus is returned to default when the camera is operated. option.

Change the Preset Order

- 1 Check the **Preset Tour** box and click **Settings...**
The **Preset Tour Settings** dialog is displayed.
- 2 Select a preset to change the order from the list, and click **Move Up** or **Move Down**.

Delete a Preset

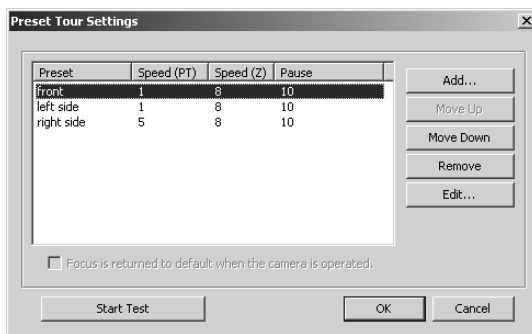

- 1 Check the **Preset Tour** box and click **Settings...**
The **Preset Tour Settings** dialog is displayed.

- 2 Select a preset to delete from the list and click **Remove**.
- 3 Click **OK**.
This returns to the **Preset Tour Settings** dialog.



Note

If the following warning appears, change the settings according to the tables below.

Warning example

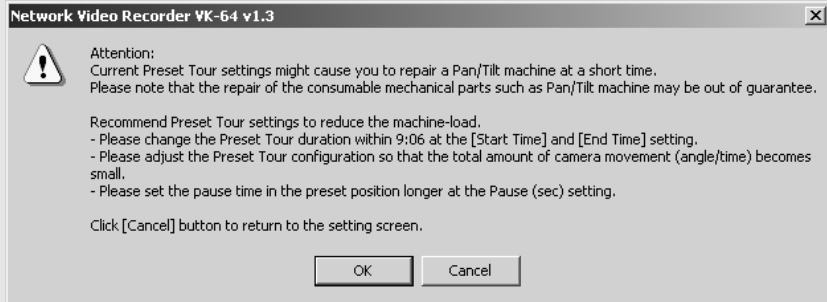

* The tour time shown depends on the settings.

Click Cancel to return to the setting screen.

Click OK to save the current settings.

(If you are using the Preset Setting Tool, click Save on the setting page of the tool)

Endurance of the pan/tilt mechanism is approximately 100,000 round trips at the full range. The total tour time depends on the combination of the movement rate, movement range, and still time. Refer to the following tables.

Total tour time for 100,000 round trips in the pan direction (estimated).

Movement rate (PT) is 1.

Still time (sec.)	Movement range in the pan direction (angle)		
	± 50	± 100	± 150
0	3872	3825	3809
10	5666	4722	4407
20	7555	5666	5037
30	9444	6611	5666

(Unit: Time)

Movement rate (PT) is 2.

Still time (sec.)	Movement range in the pan direction (angle)		
	± 50	± 100	± 150
0	1983	1936	1920
10	3777	2833	2518
20	5666	3777	3148
30	7555	4722	3777

(Unit: Time)

Example: If the movement rate (PT) is 1, still time is 30 seconds, and movement range (angle) in the pan direction is 50 degrees, it takes approximately 9,444 hours for 100,000 round trips in the pan direction.

Setting a Special Day Schedule

About Special Day Recording

The **Special Day Schedule** window is used for configuring particular days such as public holidays. When **Special Day Schedules** are set, **Normal Schedules** that conflict with the **Special Day Schedules** are disabled.



In the **Configuration and Preferences** Screen, click the **Recording Schedules** tab and ensure the **Special Day Schedule** is selected. The **Special Day Schedule** consists of:

- **Storage Server** - Select a Storage Server from the list to add/edit schedules for that server. Associated Locations and Zones are displayed in the Schedule Area.
- Schedule Type selector - Allows you to select a schedule type. These are user-defined schedules such as Public Holidays and Long Weekends.
- Days selector - Allows you to choose a day to use this schedule.
- Schedule Area - Covers a single day, 24 hours. Overrides a Normal day schedule.

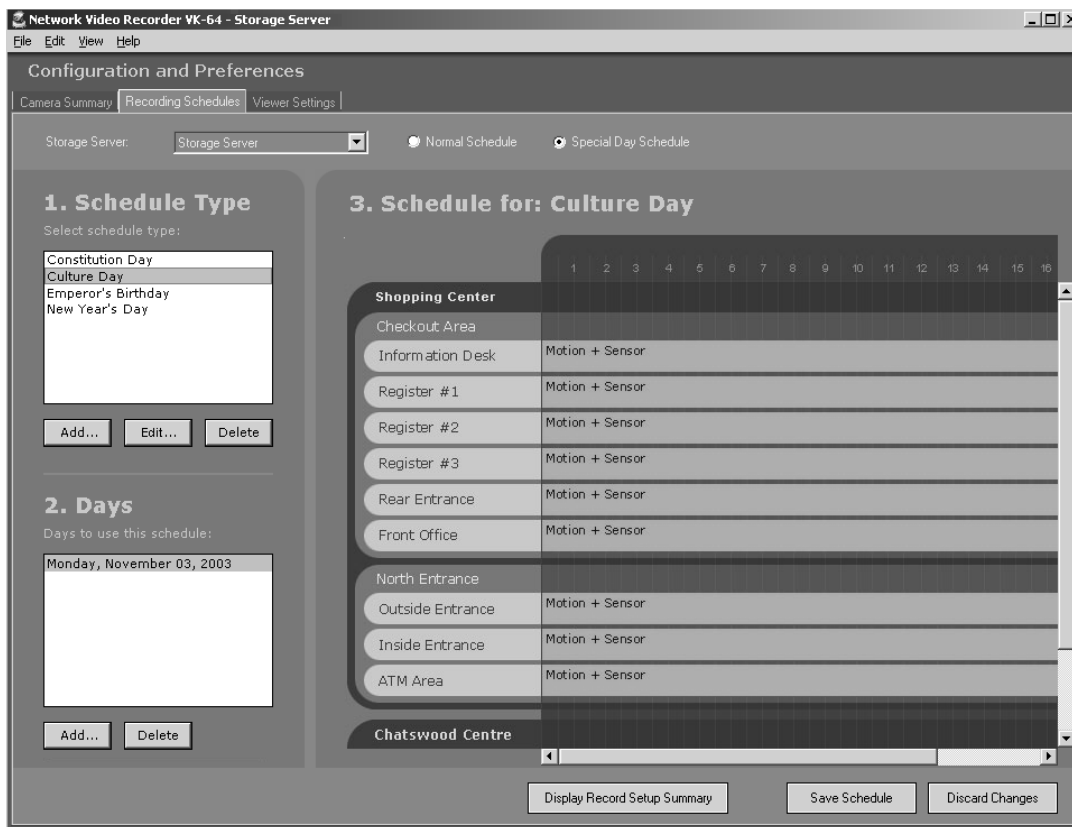

Adding, Editing and Deleting a Schedule Type

The **Add Schedule Type** dialog allows you to create a name for a new schedule type, for example, a public holiday. You must create a schedule type first before you can associate days with it. There is no limit to the number of schedule type that can be added.

To launch the dialog and add a Special Day Schedule.

● Add a Schedule Type



- 1 Click **Add...**
The **Add Schedule Type** dialog is displayed.

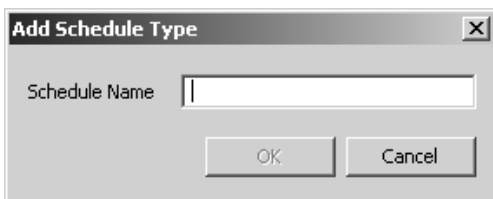

- 2 Enter a name in the **Schedule Name** area, for example "Company Holidays".
- 3 Click **OK**.
The schedule type is added and the dialog closes.

The new name will appear in the **Schedule Type** list.



Note

- The scheduling area functions the same as the Normal Recording Schedule but only covers a single day (from 00:00 hrs. to 24:00 hrs). To have a special day schedule run over a long weekend (Fri, Sat & Sun), all dates of three days must be added to the list of days to use the schedule.
- When Special Day Schedules are running, Normal Schedules are disabled. If an invalid schedule exists, the following warning message will be displayed. "There is a camera with no recording schedule. Are you sure to save the settings?"

Edit a Schedule Type



1 In the **Special Day Schedule** window, click a schedule type in the **Schedule Type** list to select it.

2 Click **Edit**.
This will bring up the **Edit Schedule Type** dialog.



Overwrite the existing name. For example, you may wish to change the name “Company Holidays” to “Company Special Days”.

3 Click **OK**.
The new settings are saved and the dialog closes.

Delete a Schedule Type



1 In the **Special Day Schedule** window, click a schedule type in the **Schedule Type** list to select it.

2 Click **Delete**.
The schedule type is deleted.



Note

If you delete a schedule type where there are dates associated with that schedule, a warning will appear. Delete the associated dates before deleting the schedule type.

Adding and Deleting a Day

The **Select Date** calendar allows you to select a day that can be used for the schedule type.

To add a day:

1. Add a Day

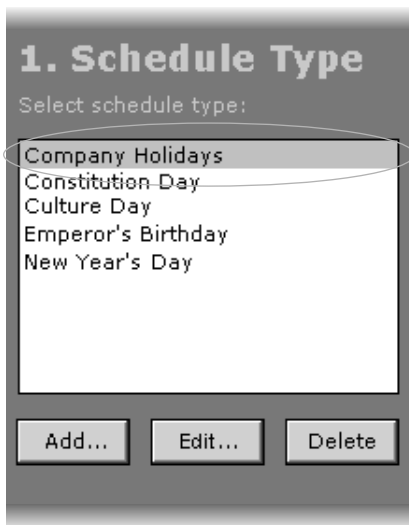

- 1 In the **Special Day Schedule** window, click a schedule type in the Schedule Type list, for example, "Company Holidays" (created on P. 137) and then in the **Days** list click **Add...**

This will bring up the **Select Date** calendar (see below).

- 2 Click to select a day in the calendar, then click **OK**.

Click **Add...** again to add another day to the same schedule type if you wish.

Added days are shown in the **Days** list (see example on next page).

Other calendar selection methods are shown on the next page.

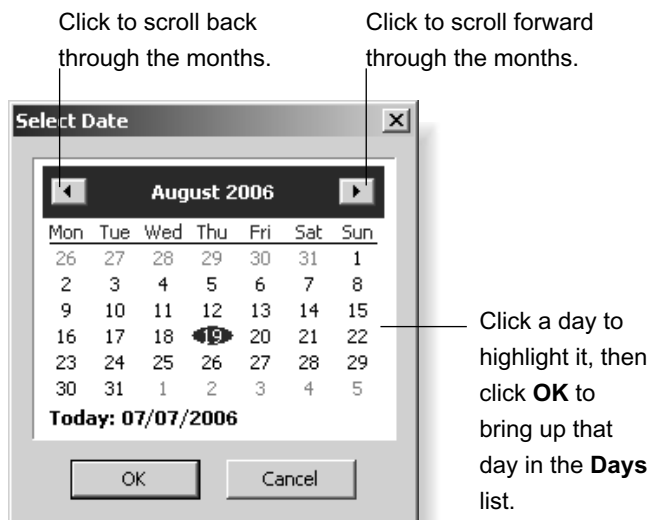
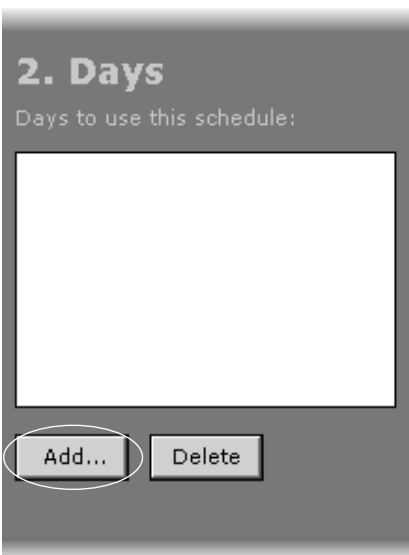

Setting a Special Day Schedule

Alternatively, click the current month and a month selector will appear.



To select another year, click the current year and scroll down or back up, using the up/down arrows.

Delete a Day

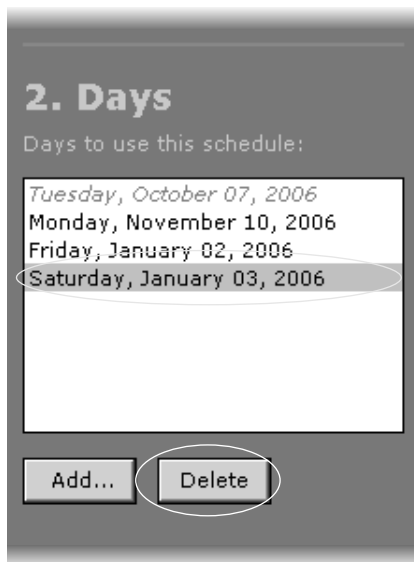

1 In the **Special Day Schedule** window, click a schedule type in the **Schedule Type** list, for example, “Company Holidays” and then in the **Days** list click one of the days associated with the schedule type.

2 Click **Delete** below the **Days** list. The day is deleted from the schedule type.



Note

- If you attempt to associate the same day with different special day schedules, you will be given a warning and asked to delete the other entry before creating a new one.
- Expired days are listed in italics.

Save Changes

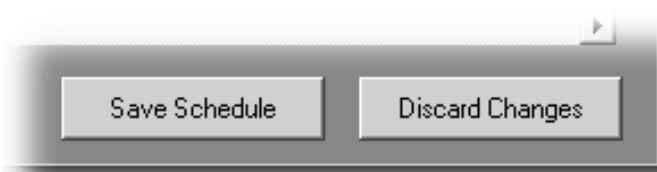
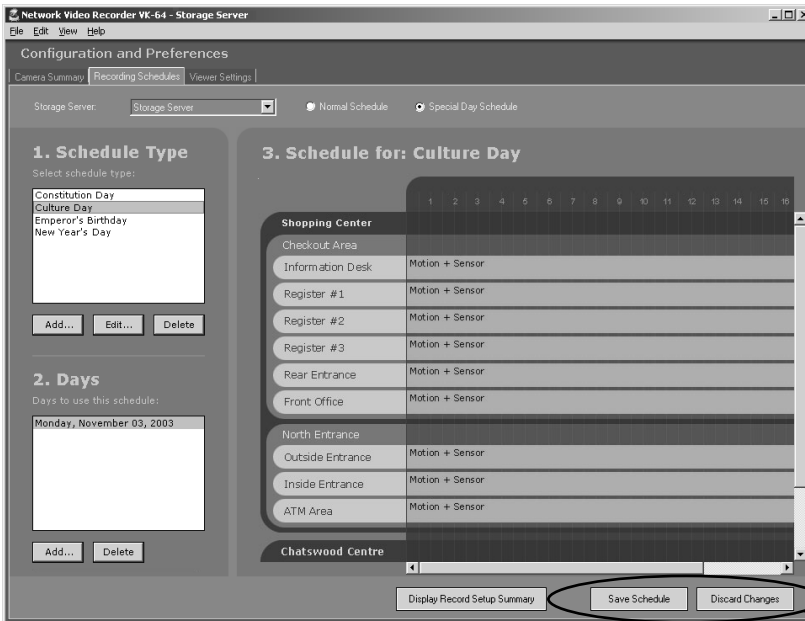

The bottom right-hand corner of the **Recording Schedule** window consists of two buttons, **Save Schedule** and **Discard Changes**.

- 1 Click **Save Schedule** to keep all your settings.
The settings are then saved to the Storage Server.
Click **Discard Changes** to cancel any changes you have made.
- 2 If you wish to return to the **Viewer**, select View > **Viewing Screen** from the menu bar.

4

Displaying the Recording Setting Summary

Display the summary information of the set recording schedule.

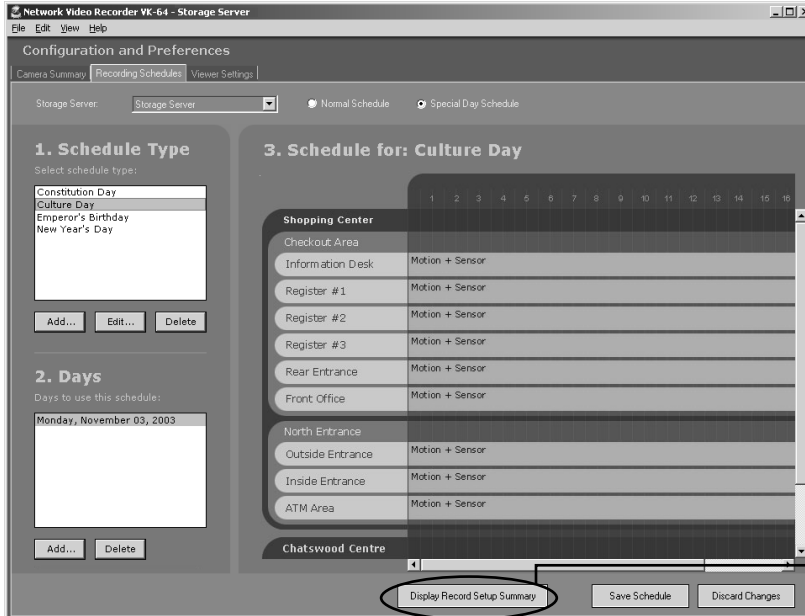

Display Record Setup Summary is located at the center-bottom of the **Special Day Schedule** window.

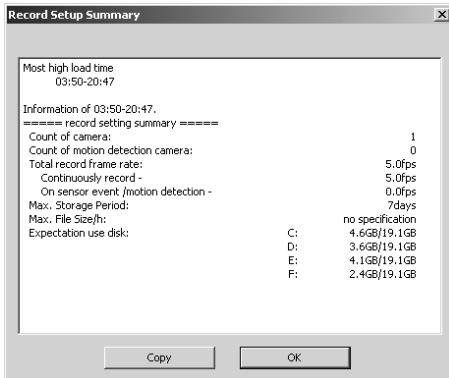

Click **Display Record Setup Summary** to display the **Record Setup Summary** dialog.

The **Record Setup Summary** dialog shows the following information for the time period where the highest load is expected when the schedule is performed.

- Number of Camera Servers
- Number of Camera Servers with Motion Detection
- Total Recording Frame Rate
 - Total Recording Frame Rate (Continuous Recording)
 - Total Recording Frame Rate (Sensor/Motion Detection Recording)
- Maximum Retained History
- Maximum File Size/Duration
- Disk Space Used

Click OK to close the **Record Setup Summary** dialog.



Note

If the load is too high, adjust the recording schedule again.



Tip

Click **Copy** to copy the contents of the Recording Setting Summary dialog to the Clipboard.



Chapter 5

Viewer Reference

Chapter Overview

This chapter outlines how to use and configure the Viewer.

● **Setting the Viewer**

Explains how to configure settings that are specific to the Viewer.

● **Arranging and Saving Layouts**

Explains how to arrange layouts and set layout sequences.

● **Video Window Operation**

Explains how to create a video window and display it in the Viewing Area and control the Camera Server.

● **Using the Timeline and Viewing Events**

Explains how to use the Timeline for live and recorded viewing as well as view and search events.

Viewer Operation Flow

Location selector (→ P. 177)

Drop-down menu indicating locations available in the system.

Menu bar

Access common menus from here.

Zone selector (→ P. 177)

Drop-down menu indicating zones within a location.

Camera Control Panel (→ P. 185)

The Camera Control Panel enables you to control a camera and quickly determine a camera position.

Event indicator (→ P. 183)

A color bar is displayed at the top of live Video Windows when an event occurs (if enabled).

Viewing Area for Video Windows (→ P. 154)

The Video Windows are arranged here. Video Windows can be re-sized. They can also be arranged into a uniform grid.

Video Window (→ P. 178)

Recorded videos and live videos are displayed in these windows.

Camera Server (→ P. 192)

Name of the Camera Server currently selected.

Playback controls (→ P. 194)

Click the VCR-like controls to play, rewind, fast forward or jump to previous and next events.

Timeline control (→ P. 192)

Scroll forwards through the current day or jump forward incrementally by day or week.

Timeline (→ P. 194)

Paste date and time as well as events which occurred are displayed here. Events are displayed as bars colored according to the priority. Click and drag the Time bar to go back or forwards in time.

Record Now button (→ P. 196)

A manual recording with duration of one minute is initiated.

Capture Still Frame button (→ P. 196)

Click to keep the current image on a Video Window.



Camera Selection Area (→ P. 176)

Thumbnails of Camera Servers added to each zone are displayed here. Thumbnail representations of cameras can be dragged onto the Viewing Area for viewing.

Video window menu icon (→ P. 188)

Select preset camera angles, custom pan, tilt and zoom, and select a Video Window size.

Live Events Log list (→ P. 199)

Indicates events that have been logged on Storage Servers after the Viewer was launched.

Zoom In/Zoom Out buttons (→ P. 197)

Click to zoom in or out of the Timeline.

Event Search button (→ P. 201)

Click to bring up a dialog and enter search details based on time range, Location/Zone and priority.

Jump to Time button (→ P. 195)

Click to enter a specific date and time to jump to, to start playing recorded video. The Timeline moves to the time selected.

Extract Video button (→ P. 198)

Click to extract a segment of video to save as another file.

Return to Live button (→ P. 198)

Click to return the Timeline Playhead to the current time. If you click this button while playing recorded video, the selected Video Window will return to live video.

Timeline Play Head (→ P. 194)

Drag the play head to a position on the Timeline to start playing back recorded video from that time.

Timeline control (→ P. 193)

Scroll forwards through the current day or jump forward incrementally by day or week.



Starting the Viewer



Note

You need the user name and password set for the VK-64/VK-16 Storage Server to start the Viewer.

Launching Procedure

Before you launch the Viewer, make sure your monitor resolution is set to a minimum of 1024 x 768 pixels.

Start the Viewer



VK Viewer

Double-click the **VK Viewer** desktop icon.

Alternatively, from the Windows **Start** menu select: **Programs > WebView Livescope > Network Video Recorder VK Series v1.3 > VK Viewer**.

The connect option menu for Storage Server is displayed. Select the **Master Storage Server** option and click **Connect**.

Start-up Screen



localhost

Connects to Storage Server and starts the Viewer. Select this option to use the local PC where Viewer is installed as the Master Storage Server.

Use IP address

Connects to Storage Server and starts the Viewer by specifying its IP address. Select this option when the Storage Server and the Viewer are installed on separate PCs.

Not use Storage Server

Select this option to use the Viewer only without connecting to a Storage Server.



Tip

If a connection error occurs, you may not have a **Master Storage Server** connected.

Connect to the localhost

If you want to use the local PC where Viewer is installed as the Master Storage Server, select localhost to start the Viewer.



1 Select **localhost** from the drop-down menu.

2 Click **Connect**.

3 Enter your **User Name** and **Password**, and click **Login**.



Note

The user name and password for the VK-64/VK-16 entered in this step are defined by your System Administrator on the he Storage Server Configuration dialog. They can be different from the user name and password used to log into Windows.

Specify the IP address of Storage Server to connect Viewer

If you installed the Viewer and Storage Server on separate PCs, specify an IP address of Storage Server and connect Viewer to the Storage Server.



1 Select **Use IP address** from the drop-down menu.

2 Click **Connect**.



3 Enter the IP address or host name of the Master Storage Server in **Host Name or IP**, and the port number in **Port**.

4 Click **Connect**.



5 Enter your **User Name** and **Password**, and click **Login**.



Note

- If you need to use a proxy server, you need to change the Internet option settings in the following procedure:

1. Select Start > Control Panel > Internet Option.
2. Select the Connection tab.
3. Click LAN settings

Change the proxy server settings.

- If using a proxy server between a Viewer and a Storage Server, it should be one which does not perform response buffering. Proxies which are configured to perform response buffering may lead to delays in sending small amounts of data (such as events) from the Storage Server to the Viewer. The Apache proxy server does perform response buffering so is not recommended.
- You cannot transmit or receive audio when using a proxy server.



Tip

The dialog for entering the IP address will also be shown even when connection to the Storage Server failed.

Use Viewer only without connecting to Storage Server (Viewer Only Mode)

You can use the Viewer only without connecting to a Storage Server. When Storage Server is not used, some functions are not available.

● Use Viewer only



1 Select **Not use Storage Server** from the drop-down menu.

2 Click **Connect**.

Functions not Available during Viewer Only Mode (Not Use Storage Server)

When you launch the Viewer with Viewer Only Mode, the following functions are not available.

● Viewing Screen

- Timeline is not displayed. **Timeline** under the **View** menu cannot be used.
- **Capture Still Frame** feature cannot be used.
- **Search Events** under the **Edit** menu cannot be used.
- **Live Events** under the **View** menu cannot be used.
- **Shared Layouts** are not displayed.
- In the **Add Layout Sequence** dialog, a **type** of layout is fixed to **Personal Layout Sequence**.

● Configuration and Preference Screen

- **Recording Schedules** tab is not displayed (→ P. 99). Some functions such as video recording, sensor events, and motion detection are not available.
- In the **Storage and Camera Server Summary**, **Storage Servers** tab is not displayed (→ P. 76).
- In the **Storage and Camera Server Summary**, the Camera Server list shows only Camera Server, Locations / Zones and Type (→ P. 77).
- In the **Add Camera Server** and **Edit Camera Server** dialog, the following items are gray (disabled):
 - **Save Recorded Video on**
 - **Camera Server Settings**
 - **Camera Settings > Save video in**
- In the **Viewer Settings** window (→ P. 156), items in the **Event Notification Settings** area are gray (disabled).

Viewer Start-up Window

When you start the VK-64/VK-16 for the first time when no Layouts have been configured, you will notice that the Viewing Area is blank as shown below. Previously-configured cameras on the network will appear as thumbnail images in the Camera Selection Area on the top of the screen. These can be dragged onto the Viewing Area for monitoring. If your Administrator has already created a Layout for you, then **the Viewing Area will display the first Personal Layout (or first Shared Layout if there are no Personal Layouts)** as shown in the example on the previous pages.

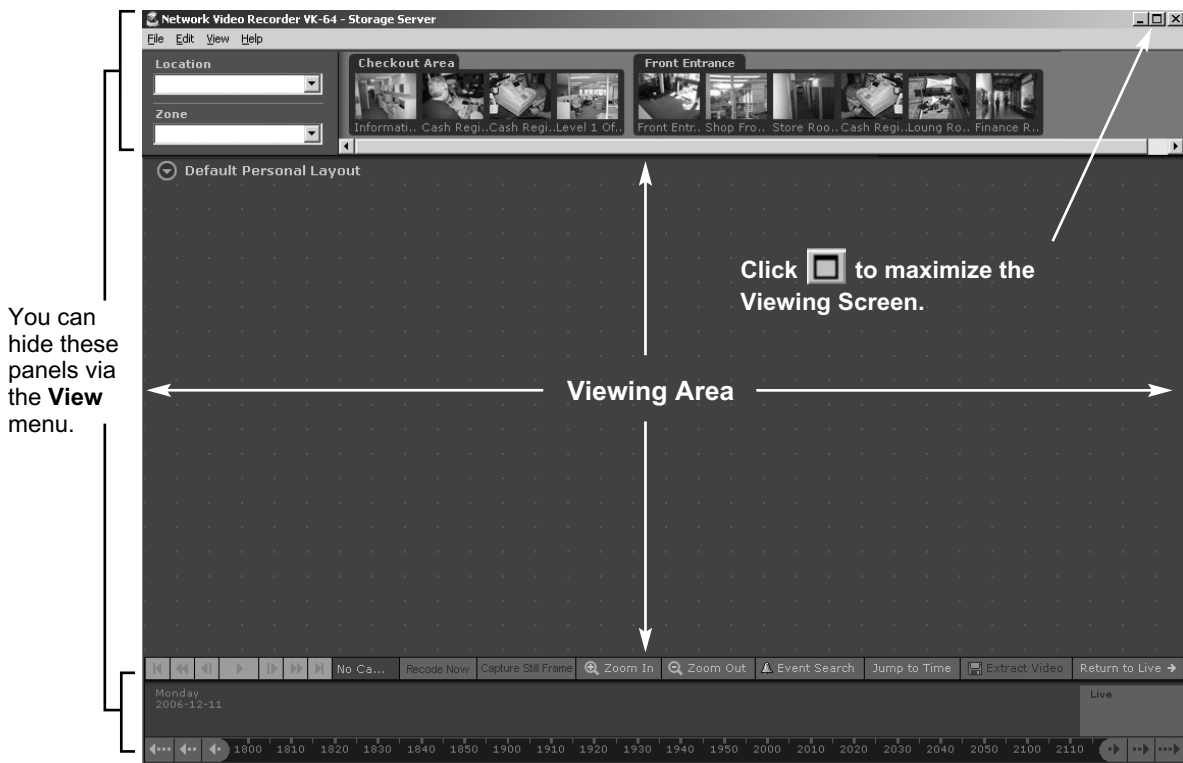

Refer to P. 165 for details on editing layouts.

Viewer Start-up Option

You can set the start-up option of the Viewer to omit the display of Start-up screen (→P. 71, P. 150) and login screen to enter a user name and password (→P. 72, P. 151).

You can place a shortcut icon on the Desktop for your convenience by following the method described below.

For this setting, you cannot use the shortcut icon that was automatically created on the Desktop after installing this software, which is used for starting the Viewer.



Note

Password can be referred through the Properties of the shortcut icon. You need to make sure that the Password is secure.

1

Right-click on the icon for **NVR_Viewer.exe** located in the installation directory and select **Create Shortcut** from the menu. The shortcut icon will be created. Move it to the Desktop.



The default destination directory is shown below.

<System Drive>:\Program Files\Canon\Webview\NVR



Tip

System Drive is a drive that contains a directory (folder) in which the Operating System files are stored. For example, if the Operating System is installed on Drive C, your system drive is Drive C.

2

Right-click on the shortcut icon that was moved onto the Desktop and select **Properties** from the menu.

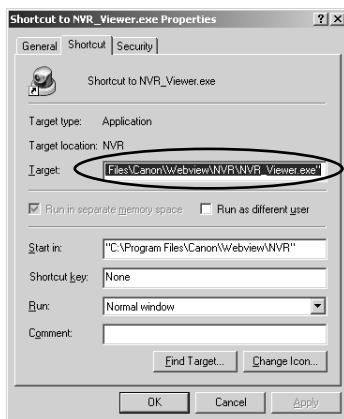

Specify **Target** as follows (using alphanumeric characters)

-h=<IP address of the Storage Server>

This specification is mandatory (→P. 73, P. 152).

-p=<port number> It can be omitted. When omitted, 80 is specified (→P. 73, P. 152).

-u=<user name> Specify the user name (→P. 72, P. 151).

-pw=<password> Specify the password (→P. 72, P. 151).

-u and -pw can be omitted. When omitted, the start-up screen will not be displayed (→P. 71, P. 150). Instead, the login screen for entering a username and password is displayed. When you use the Viewer alone, you also need to specify "nohost" for -h.

Example

"C:\Program Files\Canon\Webview\NVR\NVR_Viewer.exe" -h=192.168.100.1 -p=80 -u=admin -pw=NVR

Make sure to enter a space after

"C:\Program Files\Canon\Webview\NVR\NVR_Viewer.exe".

Setting the Viewer

About the Viewer Settings window

The **Viewer Settings** window is used for settings such as notification priorities and the live viewing frame rate. Settings are stored on the Viewer PC, not on the Master Storage Server.



This window consists of:

- **Video Viewing Settings** - Select the maximum viewing frame rate for live videos.
- **Master Storage Server** - The current Storage Server is indicated. You can switch to display or not to display the Master Storage Server option window (connect menu) on start-up, and also add/delete Master Storage Server into/from the connect menu.
- **Proxy Setting** - Use this option to make an access to Storage Server via proxy server.
- **Layout setting** - Confirm if the layout was preserved when quitting or when the screen changes.
- **Event Notification Settings** - Set operator notification and adjust duration in seconds, set operator acknowledgement (recognition) of an event, set an audio alert, and suppress event display.
- **Audio Setting** - Set automatic termination of audio transmission after a specified period of time.
- **Focus Operation Setting** - Set the focus position to return to the default setting of the camera when operating the camera.

Maximum frame rate for live viewing

Event Notification Settings area

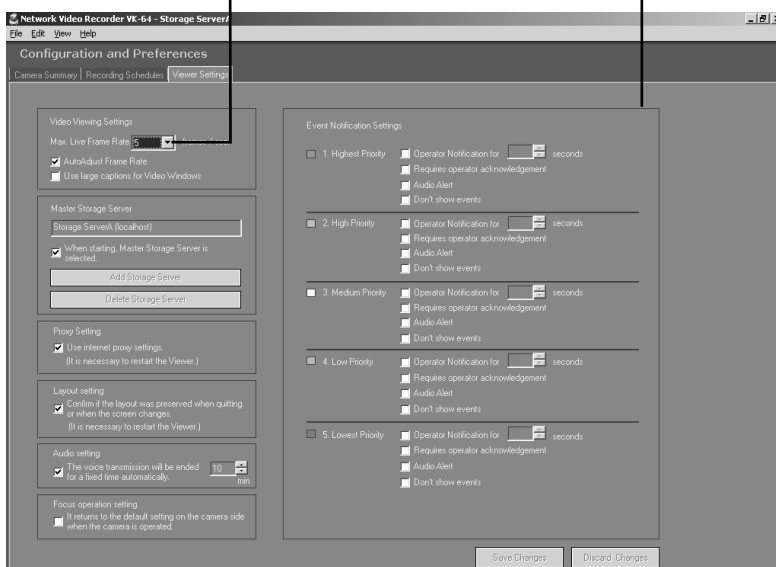

Video Viewing Settings

- Max. Live Frame Rate: 5 frames / sec. (Maximum frame rate for live viewing. Select a frame rate from the drop-down list.)
- AutoAdjust Frame Rate (Adjust frame rates automatically.)
- Use large captions for Video Windows (Enable larger Video Window captions in the Viewer.)

Master Storage Server

- Storage ServerA (localhost) (The current Master Storage Server is indicated.)
- When starting, Master Storage Server is selected. (You can select the Master Storage Server when launching the Viewer (→P. 71, P. 150).)
- Add Storage Server (Add the current Storage Server into connect menu.)
- Delete Storage Server (Delete the current Storage Server form connect menu.)

Note If a high maximum frame rate is specified, the load on the computer CPU will be high and Viewer operations may take longer. When Auto Adjust Frame Rate is ticked, frame rate is automatically reduced when CPU load becomes high.

Set up notifications by priority from 1 (highest) to 5 (lowest). Priorities are color-coded as follows.

Color	Priority
Red	Highest
Orange	High
Yellow	Medium
Light Green	Low
Dark Green	Lowest

Lower priority items can have less notification settings associated with them.

When ticked even if an event occurs, it is not displayed in the Live Events Log in the Viewing Screen.

Event Notification Settings

- 1. Highest Priority (Operator Notification for 30 seconds)
 - Requires operator acknowledgement
 - Audio Alert
 - Don't show events
- 2. High Priority (Operator Notification for 30 seconds)
 - Requires operator acknowledgement
 - Audio Alert
 - Don't show events
- 3. Medium Priority (Operator Notification for 30 seconds)
 - Requires operator acknowledgement
 - Audio Alert
 - Don't show events
- 4. Low Priority (Operator Notification for 30 seconds)
 - Requires operator acknowledgement
 - Audio Alert
 - Don't show events
- 5. Lowest Priority (Operator Notification for 30 seconds)
 - Requires operator acknowledgement
 - Audio Alert
 - Don't show events

Set duration of alert.

Viewer Settings window - Use large captions for Video Windows

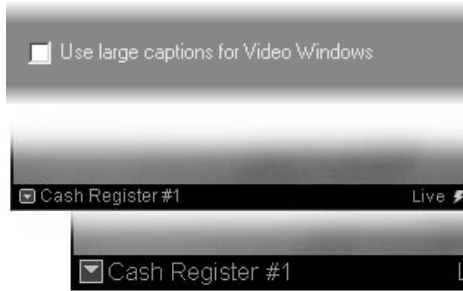

Tick **Use large captions for Video Windows** to enable easier-to-read Video Window captions in the Viewer.

Standard caption in Video Window.

Large caption in Video Window.

Viewer Settings window - Identify the Master Storage Server

A Master Storage Server maintains settings for Camera Servers and Layouts.

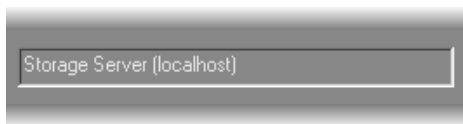

The selected Master Storage Server is indicated in the **Viewer Settings** window.

Viewer Settings window - Configure the proxy server



When you wish to access the Storage Server **Using the proxy server set in the Internet Option**, tick Use internet proxy settings and restart the Viewer.

Viewer Settings window - Configure layout in the Viewing Screen

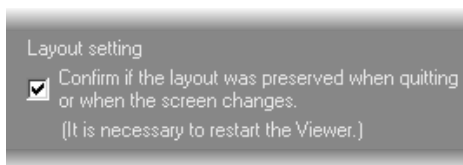

If you wish to confirm whether the layout information has already been saved when finishing the Viewer or when switching to the Viewing Screen, tick the **Confirm if the layout was preserved when quitting or when the screen changes** check box and restart the Viewer. If not ticked, the layout information will not be saved.

Viewer Settings window - Audio Transmission Settings

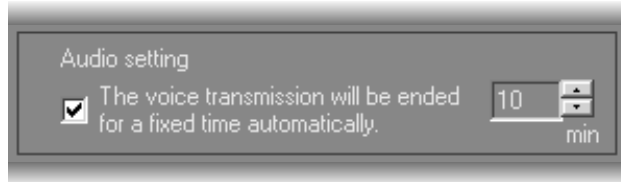

The camera which is sending or receiving audio to a Viewer cannot interact with other Admin or NC Viewers. Audio transmission and reception can be terminated automatically even if you forget to disconnect the audio connection.

When using this option, tick **The voice transmission will be ended for fixed time automatically** check box, and specify the period within the range from 1 to 60 minutes (default is 10 minutes). When the specified period of time passes during audio transmission, it will be terminated automatically.



Tip

Automatic termination works even if the servers are communicating with each other. Switching to another Video Window resets the time.

Viewer Settings window - Configure Focus Settings

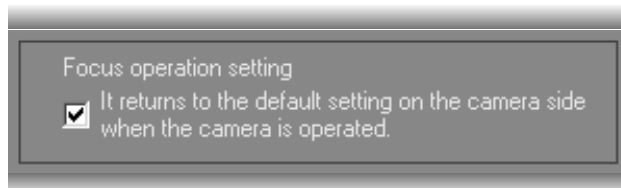

You can set the camera to return its focus mode to the default setting when the camera orientation is changed. The focus mode returns to default if it has been changed to Manual after any focus operation using a preset with focus setting defined or via Camera Control Panel.

Use this option by ticking the **It returns to the default setting on the camera side when the camera is operated** check box.

Viewer Settings window - Edit Event Notifications

When an event occurs, it is indicated in the **Live Events Log** in the Viewer. In the **Viewer Settings** window, **Event Notification Settings** area, you can set up actions based on events according to the priority of the event. To set the event notifications.

Set priority alerts from Highest to Lowest

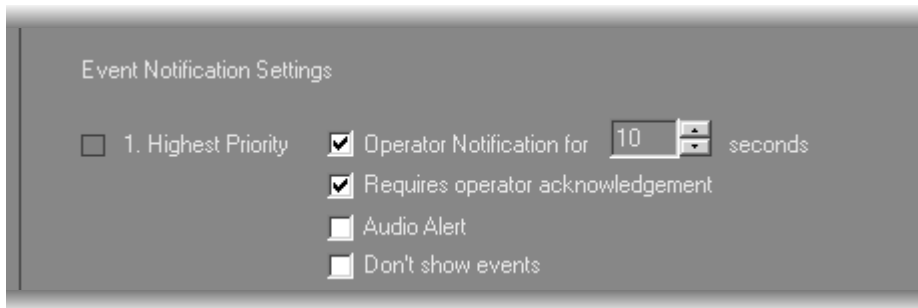

In the Priority area, you configure the following settings:

1 Tick the **Operator Notification** for box to enable a notification period when an event occurs. Select a notification period in seconds from the **Seconds** drop-down menu or enter it from the keyboard (0 - 99). When a event occurs, the event flashes in the **Live Event Log** window for the period of time specified using this option, and a color bar indicating the event's priority light on the top of a live Video Window for one minute.

If you specify 0 second, an event which has occurred will not flash and a color bar will light for one minute.

2 Tick the **Requires operator acknowledgement** box for the event. When an event occurs it will flash in the **Live Events Log** and the audio alert will sound (if specified) until the operator double-clicks on the event (that is, the notification time will not apply to the event in the event log). (That is, the notification time will not apply to the event in the event log.)

3 Tick the **Audio Alert** box to have an audio alert play during the event notification period.

The Windows system sound "Exclamation" is used for audio alerts (For a PC with no sound board installed, a beep sound is used). This sound repeats for the duration of the **Operator Notification**. If **Operator Notification** is not set, the audio alert is played once.

4 Tick the **Don't show events** to have the event not displayed on the Timeline of the Viewing screen or on the **Live Events Log** window even if the event occurs.



Tip

Even if Don't show event is ticked, events are shown in the Search Results in the Event Search dialog.

Saving Viewer Settings

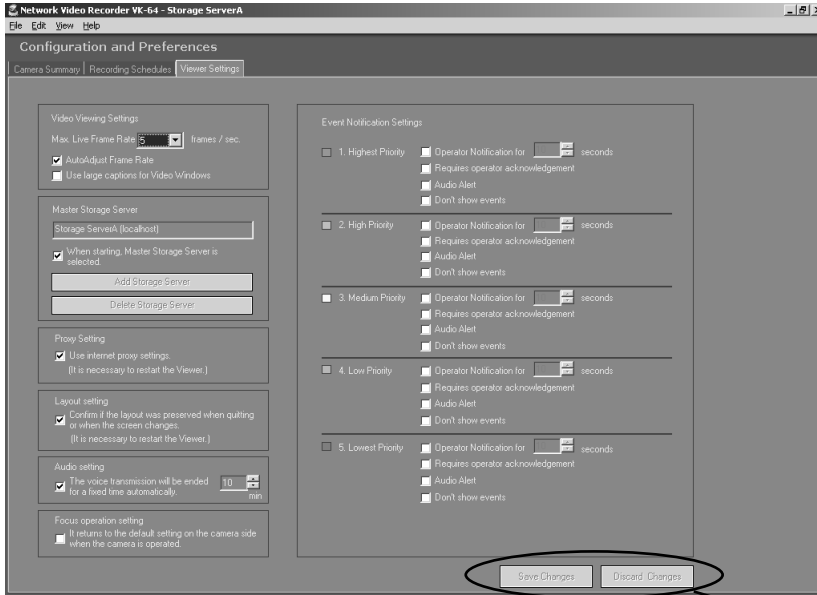

The bottom right-hand corner of the **Viewer Settings** window consists of two buttons, **Save Changes** and **Discard Changes**.

- Click **Save Changes** to keep all your settings. The Viewer settings are then saved to the local disk.



Click **Discard Changes** to cancel any modifications you have made.

- If you wish to return to the Viewer, select **View > Viewing Screen** from the menu bar.

Arranging and Saving Layouts

This chapter details how to create and save Video Window Layouts and Layout Sequences.

■ Managing Video Layouts

About the Layout menu

The **Layout** menu allows you to save particular Video Window layouts for easy monitoring.



The name of the currently-displayed layout can be found in the top-left corner of the Viewing Area, next to the Layout button. You can create a new layout, save a layout or open and rename a previously-saved layout.

Click the Layout button to open the Layout menu. You can also right-click anywhere in the Viewing Area to display the Layout menu.

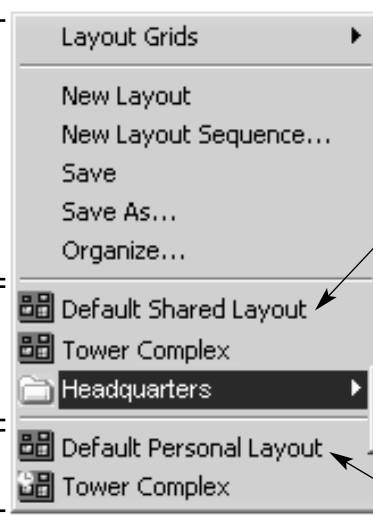

Optional Layout Menu

- Layout Grids
- New Layout
- New Layout Sequence...
- Save
- Save As...
- Organize...

Shared Layout List

- Default Shared Layout
- Tower Complex
- Headquarters

Personal Layout List

- Default Personal Layout
- Tower Complex

Shared Layouts:

- Spy Center
- Rocket Base Complex

Personal Layouts:

Below the Layout menu options, existing Layouts are displayed and divided into two sections.

All the users can available these layouts. You need Administrator privilege to create a layout (→ P. 66). Normal users cannot modify these layouts.

Lists layouts created by the current user. These are shown under the Shared Layouts list to distinguish the different types of layouts. Other users cannot use them.



Tip

The layout displayed when launching the Viewer is the first layout listed in the Personal Layouts (or in the Shared Layouts if there is no Personal Layouts).

● **To create a new layout (a previously-saved layout is displayed):**



Click the Layout button to open the menu, and then select **New Layout**.

The Viewing Area will become blank and the default layout name “Untitled” will be displayed.

The process of creating folders and saving a layout could be done in the following order:

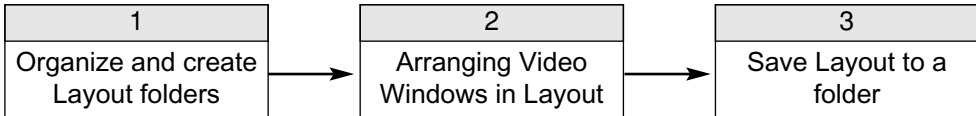

Drag the Camera Server’s thumbnails onto the Viewing Area to create the layout.

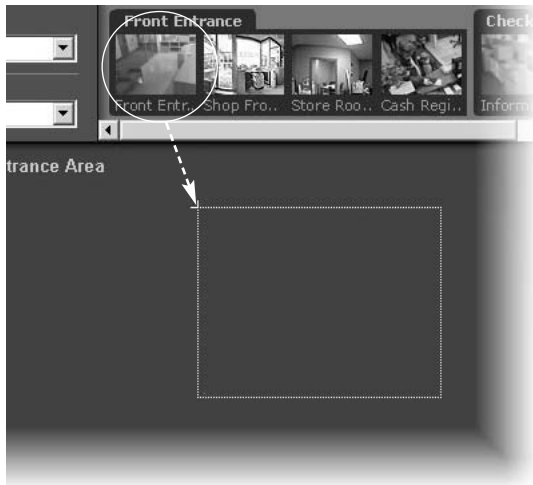

Organizing Layouts and Layout Sequences

The **Organize Layouts & Layout Sequences** dialog allows you to create folders and sub-folders in which to save item (layouts and layout sequences) (→ P. 166). To display the dialog:

● Open the Layout menu and select **Organize...**

The **Organize Layouts & Layout Sequences** dialog opens (Administrator version shown). The **Shared Layouts** folder will not display if you have logged in as an Operator.

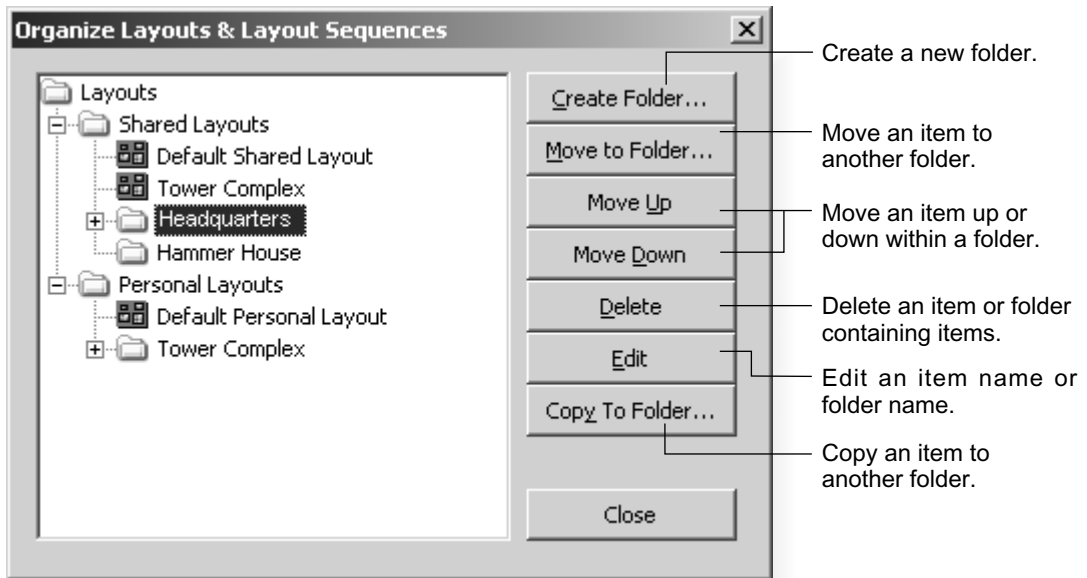

● Create a new folder...

1 In the **Organize Layouts & Layout Sequences** dialog, click on a shared or personal folder and then click **Create Folder....** The Folder Name dialog appears.

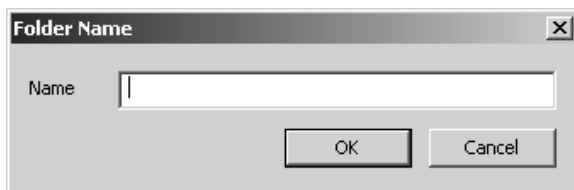

2 Enter a name up to 50 characters and click **OK**.

The new folder will appear in the **Organize Layouts & Layout Sequences** dialog.

● Move or Copy a layout or layout Sequence to another folder...

1 In the **Organize Layouts & Layout Sequences** dialog, click an item to highlight it, then click **Move to Folder...**

The Select destination folder dialog opens showing a list of created folders.

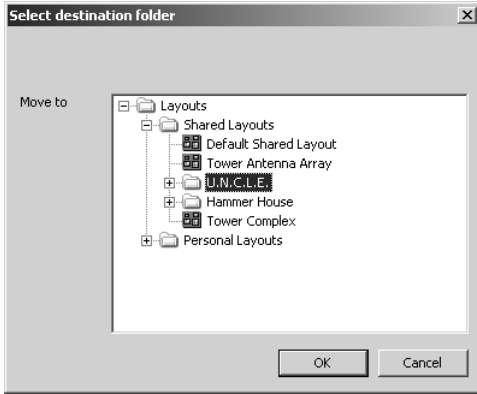

2 Click to select the target folder in the list and click **OK**.

The item will be moved into that folder.

If you selected **Copy to Folder...**, you can copy items in the same manner.

● Move an entry up or down...

Click an item or folder to highlight it, then click **Move Up** or **Move Down**. The item will move up or down within a folder.

● Edit or delete a layout or folder...

Click an item or folder to highlight it, then click **Edit**. The respective **Layout Name** or **Folder Name** dialog will appear for you to overwrite a new name.

Click an item or folder to highlight it, then click **Delete**. If you have Operator status, you will not be able to delete a shared layout or layout sequence.



Note

- You cannot change the parent folder names, Shared Layouts or Personal Layouts.
- You need Administrator privilege to manage shared folders (→P. 66).

Saving a Layout or Layout Sequence

Administrators and Operators can save layouts and layout sequences to an existing folder or a new folder via the **Save Layout** dialog.

Step 1: Open the Layout menu and select **Save** or **Save As...**

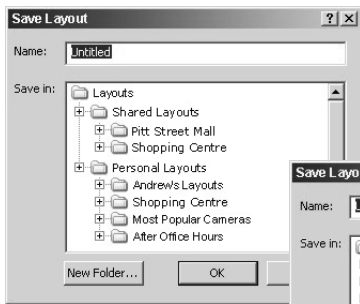

Operator's **Save Layout** dialog

The **Save Layout** dialog opens. A **New Folder** button and **Name** field is also available for you to create a new name and location for the copied layout or layout sequence.

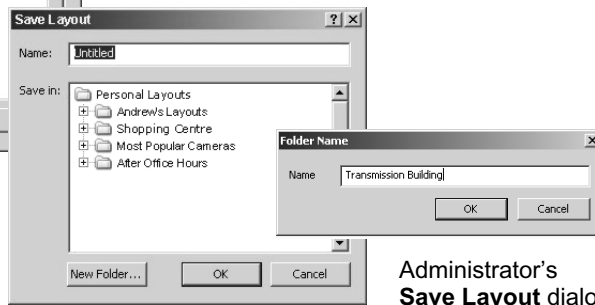

Administrator's **Save Layout** dialog

Step 2: Create a name for the layout or layout sequence

- 1 Change **“Untitled”** or an existing layout name to save the item with a new name.
- 2 Click a location in the list. Click to select the folder to save the layout and click **OK**. The item is saved to that folder.

Alternatively, click **Create Folder...** to create a new folder (→ P. 164) and save the item in there. For example, if you wish to save an Administrator-shared layout to a personal folder.

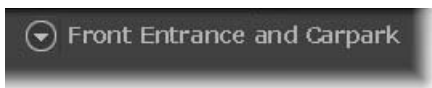

Once you have saved an item, the name will appear next to the **Layout** button in the **Viewing Area**.

● Opening a previously-saved layout...

Click the Layout button to open the menu and then click a layout or layout sequence in the list. The item will be loaded onto the Viewing Area.

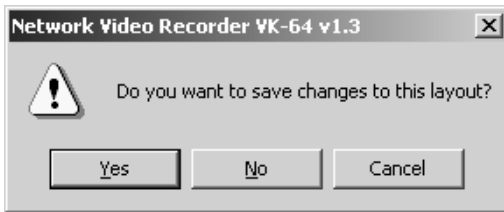

If you select another item without saving the current item, a dialog will appear prompting you to save the current layout or layout sequence (if the **Layout setting** (→ P. 158) in the **Viewer Settings** window is ticked).

Arranging Layout Sequences

You can set up an automated sequence of shared and personal layouts to display in the Viewing Area at set intervals.

- 1 From the Layout menu, select **New Layout Sequence....** The **Add Layout Sequence** dialog displays.
- 2 Enter a sequence name for the new layout sequence and choose a **Type** of layout sequence from the menu, **Personal Layout Sequence** or **Shared Layout Sequence** (you can switch between the two as you add layouts).
- 3 Use the **Add Layout >** button to add layouts to the new sequence. Click **Up** and **Down** to change the display sequence of layouts. Click **Delete** to delete the layout.
- 4 In the **Duration** menu, select a set duration of display time for each layout or enter a custom time, overwriting the existing time.

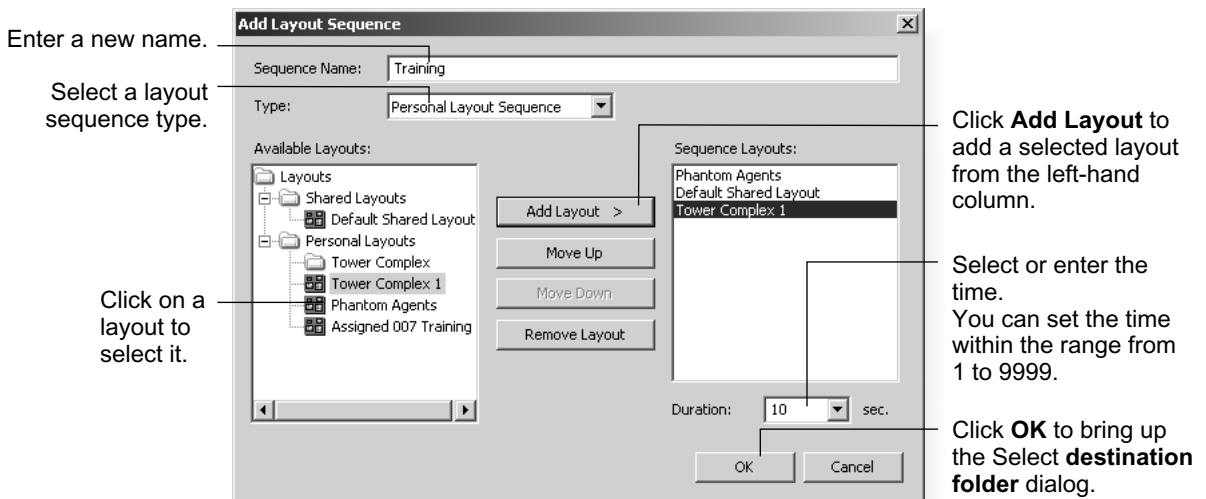

Layout Sequence:

All the users can share these layouts. You need Administrator privilege to create a layout sequence. Normal users cannot modify these layouts.

User Layout Sequence:

Lists layouts created by the current user. Other users cannot use them.



Note

- You can only save layouts as a layout sequence.
- VB101 cannot be used for layout sequence.

Opening and running a layout sequence...

To start the layout sequence, select it from the Layout menu.

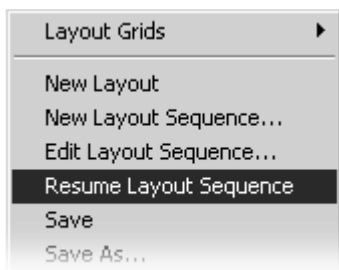

When a layout sequence is running, further options are available in the Layout menu.

- Click **Edit Layout Sequence** to change settings in the currently-running layout sequence. The current sequence will be indicated as **Paused**.
- Click **Resume Layout Sequence** to play the current layout sequence.

■ Working with Layout Grids

You can customize your layouts by applying one of the following grids:

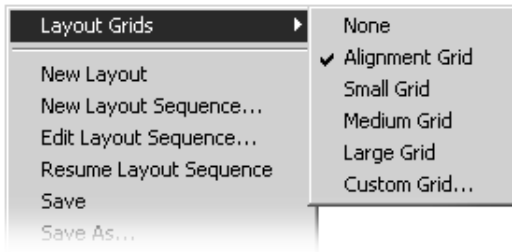

- **None** - You can arrange Video Windows freely.
- **Alignment Grid** - creates a grid of dots in the Viewing Area. You can re-size Video Windows using the grid.

- **Small Grid, Medium Grid and Large Grid** - creates a small (160x120), medium (320x240) or large (640x480) grid where you can place Video Windows in a tile-like manner.
- **Custom Grid** - You can set the grid size (→ P. 174).

Working with the Alignment Grid

Select the **Alignment Grid** from the **Layout Grids** sub-menu. The Viewing Area displays a grid of dots. When you place a Video Window, it “snaps” to the grid boundaries.

● Drag, drop and re-size a Video Window

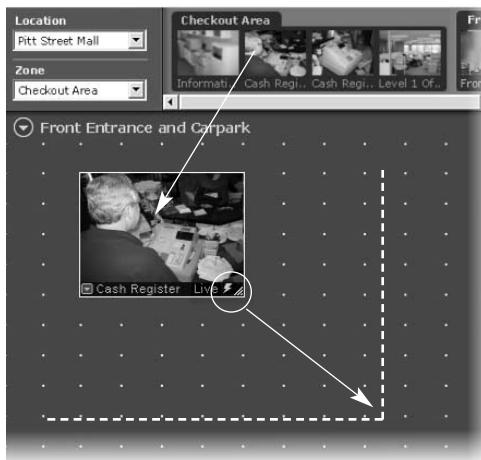

- 1 In the Camera Selection Area, click a thumbnail image and drag its selection boundary onto the Viewing Area grid. The boundary will re-size.
- 2 Release the mouse button. The selection will become a Video Window, and “snap” into alignment along the grid closest to it.

To re-size the Video Window, click any corner and drag the image outwards to snap to a larger grid area. Release the mouse button. The selection boundary will become a Video Window and “snap” into alignment along the grid closest to it.



● Create and align more Video Windows

Click and drag other camera thumbnails onto the Viewing Area to create Video Windows for monitoring, and resize the window. A layout example is shown to the right.



Working with Small, Medium and Large Grids

When you select **Small Grid**, **Medium Grid** or **Large Grid** from the **Layout Grids** sub-menu, the Viewing Area displays “cells” for Video Windows. These are boundaries indicating a uniform size which is used to display Video Windows in a tile-like manner.

Drag a camera thumbnail image into a blank tile

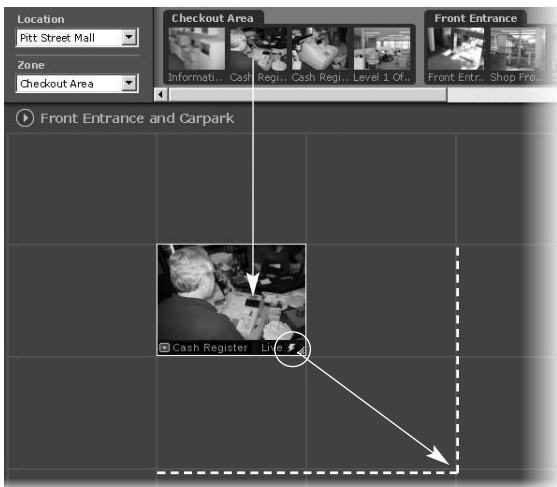

- 1 In the Camera Selection Area, click a thumbnail image and drag its selection boundary onto the Viewing Area grid. The boundary will re-size.
- 2 Release the mouse button. The selection boundary will become a Video Window and “snap” into alignment along the grid closest to it.

To re-size the Video Window, click any corner and drag the image outwards to ‘snap’ to a larger grid area. Release the mouse button. The selection boundary will become a Video Window and “snap” into alignment along the grid closest to it.



Tip

- The Layout menu is also available by right-clicking anywhere in the Viewing Area.
- A Video Window can be increased in size to take up a number of tiles, (for example 4 tiles, 9 tiles etc) so that Video Windows of different sizes/priorities can be viewed.

Arranging and Saving Layouts

The Viewing Area with a **Small Grid** could look like this:



The Viewing Area with a **Medium Grid** could look like this:



Note

Although you can add more, the number of Video Windows you can display simultaneously will depend on your video card, the speed of your computer, the maximum frame rate (→P. 157) configured with Viewer setting, the video size and video quality coming from the Camera Server and the size of each Video Window displayed. A maximum of 16 cameras is recommended in the Layout Area.

The Viewing Area with a **Large Grid** could look like this:



In this example, the Camera Selection Area and Timeline are hidden (→ P. 173).

Working with the Custom Grid

The Custom Grid feature allows you to set a custom-size for displaying Video Windows.

● Set a custom grid

- 1 Select **Custom Grid** from the **Layout Grids** sub-menu. The **Custom Grid** dialog appears. Values are given in pixels.

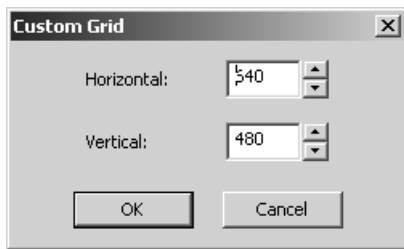

- 2 In the **Horizontal** or **Vertical** field, overwrite the existing value with a custom value, or use the up/down arrows to select a value. When you adjust the value in one field, you'll notice the value change in the other field. This is because the proportions of the re-sized Video Window are constrained and the dimensions are scaled accordingly.

- 3 Click **OK** to close the dialog. The grid will re-size to your new settings.



Note

Using Custom Grid may cause high CPU load.

■ Hiding and Showing Task Areas

The **View** menu allows you to show/hide task areas and other display elements in the Viewer. When you unselect **Camera Selector** and **Timeline** and then select **Fullscreen**, the result is a large area in the Viewer for displaying more Video Windows as shown below in the Large Grid example. Pressing the Esc key returns the menu bar. You can also select to hide Video Window **Captions**, the **Camera Control** and **Live Events**.

The number of Video Windows in the display achieved is dependent on the display resolution. A higher resolution will result in more Video Windows displayed.

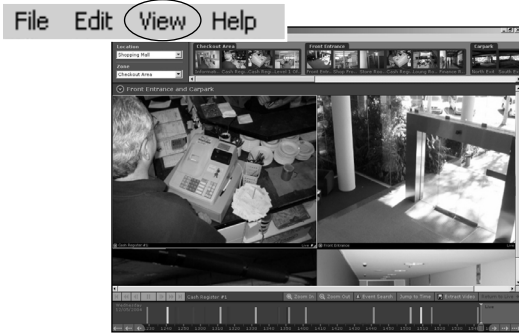

View → Camera Selector

View → Timeline

View → Full-Screen (Large grid, 1280x1024). The Windows task bar is also hidden. Pressing the **ESC** key displays the task bar.



Basic Video Window Functions

This section shows you how to create Video Windows for viewing in the Viewing Area and how to adjust camera angles.

■ Selecting Cameras for Viewing

About the Camera Selection Area

The Camera Selection Area is used to display thumbnails of all the cameras. You can select another set of thumbnails of currently-available cameras via the **Location** and **Zone** drop-down menus and then place them into the Viewing Area as Video Windows.

- The **Location** drop-down menu lists the physical locations of cameras on the system.
- The **Zone** drop-down menu lists the groups of areas within each location.



When you select a location, its associated zones will be listed below.

About Camera Thumbnails

When a Location is selected, the thumbnail images of the Camera Servers registered in that Location will appear. Depending on the number of cameras in the selected Location, a scrollbar at the base of the Camera Selection Area can be used to scroll the display of thumbnails.



Each Zone is grouped into camera thumbnail images and these can be dragged onto the Viewing Area to create Video Windows.



Note

Locations, zones and thumbnails are configured and managed by users with Administrator privileges.



Tip

You can hide the Camera Selection Area to allow more display space for Video Windows. From the View menu, select Camera Selector to hide/show the Camera Selection Area.

Selecting Locations and their Zones

Selection is performed in the following order:

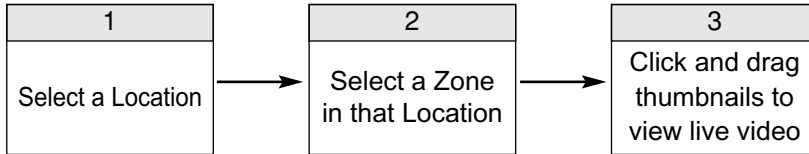

Step 1: Select a Location from the drop-down menu



Click the **Location** drop-down menu or on the down arrow.

A list of pre-configured locations appears.

Click a location in the list. Zones for that list will appear in the thumbnail section to the right.

Step 2: Select a Zone from the menu or thumbnail folder region



Click the **Zone** drop-down menu or on the down arrow.

A list of pre-configured zones appears.

Click a zone in the list.

Once a Zone is selected from the drop-down menu, the Camera Selection Area for the selected Zone moves to the left.

Alternatively, click the scrollbar located under the Camera Selection Area. Drag it to the right until the desired Zone is displayed.



■ Basic Video Window Functions

Creating, scaling and moving Video Windows

Once you have chosen a location and chosen a zone, you are ready to view one or more cameras in that zone. Camera thumbnail images are used to create Video Windows in the Viewing Area. The Viewing Area can support multiple Video Windows for live monitoring and viewing recorded video simultaneously.

● Click and drag a camera thumbnail onto the Viewing Area

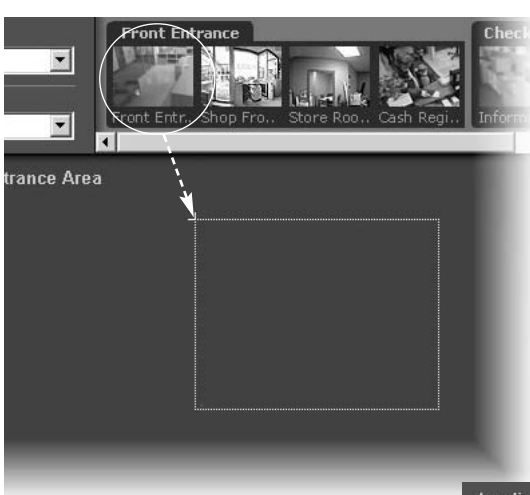

- 1 Click the thumbnail image and, while holding down the mouse button, drag its boundary anywhere onto the Viewing Area.
- 2 Release the mouse button. The re-sized outline becomes a live Video Window.

When placed, the Video Window is re-sized and re-positioned according to the **Layout Grid**.

A selected Video Window is highlighted.



Note

Could not connect to camera

Cash Register #1 Live

An error message will appear in the Video Window if there is a connection problem.

Re-size a Video Window

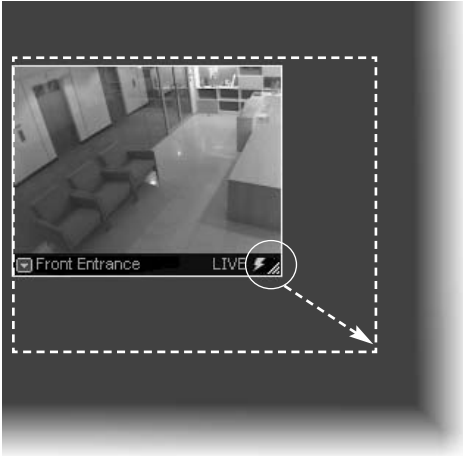

1 Click a Video Window to highlight it. An arrow icon will appear in the lower right corner. Click the arrow icon and drag outwards. You can also click on the other corners and drag to re-size the window.

Release the mouse button when you have reached the desired size.

2 Alternatively, click the Video Window menu button and select Video Display Size. Select **Video Receive Size** from the menu, and then select **Small, Medium, Large, or Default** from the sub-menu.

A right-click action on the Video Window will also bring up the same menu.

Move a Video Window



Click anywhere on a Video Window and drag it to any position in the Viewing Area.



Note

- For best performance on the Viewer, such as to view as many Video Windows as possible, re-size (160x120, 320x240, 640x480) the Video Windows so they are a standard resolution.
- When Video Windows that are other than a standard resolution are displayed, the load on the computer CPU will be high and Viewer operations may take longer.

● Add more Video Windows

Click and drag other camera thumbnails onto the Viewing Area to create Video Windows for monitoring. Your Viewing Screen could look like this.



Arranging Video Windows

There are various ways you can manage the layout of Video Windows in the Viewing Area (→ P. 170).



Note

- In the Viewer, the number of Video Windows you can display simultaneously will depend on your video card, the resolution and quality settings of the camera and the Live Video Viewing Settings (frame rate) set in the Viewer Settings window of the Configuration and Preferences screen.
- If the load on the computer CPU is high, Viewer operations may take longer.

Selecting Multiple Video Windows

You can select multiple video windows easily. You can also move, cut, or copy selected multiple windows simultaneously.

Selecting Multiple Video Windows



There are three ways to select multiple windows:

- On your keyboard, hold down the **Ctrl** key and click each Video Window to select them, or,



- Click outside the Video Windows and drag a selection box around the Video Windows you want selected, as shown below. Only windows contained within the area of selection are selected. Dragging around part of an image will not select it.
- If you wish to select all Video Windows, click **Select All** from the **Edit** menu (or on your keyboard press **Ctrl + A**).



Tip

- Video Windows from different zones and locations can be displayed in the same Layout.
- You can copy and paste a multiple selection of Video Windows t one time which can be pasted into and saved as a new Layout.

Video Window States

Video Window Properties include:

- **Title bar** - indicates name of camera, live or recorded viewing.
- **Video display** - displays live or recorded information.
- **Recorded video indicator** - displays a time/date stamp in the title bar for recorded footage.
- **Event indicator** - displays a colored bar across the top of the Video Window.
- **Pan, tilt and zoom controls** - when the Video Window is double-clicked or the Video Window menu item, **Get Camera Control** is selected, controls appear to enable pan, tilt and zoom.

About Video Window states

Video Windows can be displayed in the Viewing Area according to their conditions:

- **Live** - when viewing live video from a Camera Server.
- **Recorded** - Displays recorded video from a Storage Server.

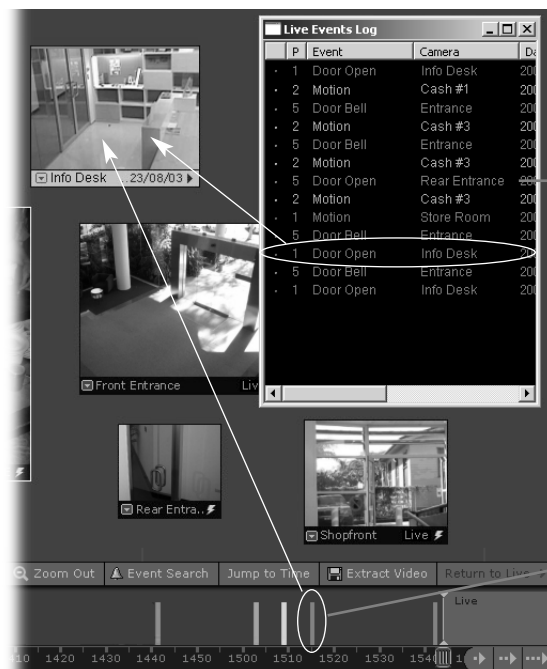

Live Events Log list

Double-click an event to view it in the corresponding Video Window. The **Live Events Log** opens automatically when you launch the Viewer, if left open in a previous session.

Recorded

Click to view recorded footage in the corresponding Video Window.



Note

The full camera name/event may not display if you reduce the size of the window.



Each Video Window displays video from an individual camera. Video Windows can be re-sized, repositioned or closed.

● **Title bar**

The title bar consists of menu, camera name and live or recorded status.

● **Video display conditions**

Live video



Recorded video, Playback



The lightning symbol  in the lower right-hand corner indicates live video.

● **Recorded Video Indicator**

When recorded video is shown, the title bar on a Video Window will change from black to gray.



For recorded video, the time/date indicator may not fully display if the Video Window size has been reduced.

● **Event Indicator**

If the option for **Operator Notification** has been set, a color bar will flash on top of a live Video Window when an event occurs. The color indicates the event priority. The bar will flash for a pre-defined time and then remain steady for one minute until disappearing. An audio alert may also sound if pre-defined.



Color	Priority
Red	Highest
Orange	High
Yellow	Medium
Light Green	Low
Dark Green	Lowest

■ Adjust Pan, Tilt and Zoom

This is done in one of three ways:

- Directly from within the Video Window
- Using the Camera Control Panel
- Selecting a Preset



Note

- For a VB-C50FSi and VB-C50Fi, only zoom is available.
- If a fixed camera or an external camera such as VC-C50i is connected to VB-C50i, you cannot use pan, tilt, and zoom operations.

● Using the Camera Directly from within the Video Window

Enable the controls by double-clicking on a live Video Window.



Front Entrance

Alternatively, click the down-arrow at the base of the Video Window (or right-click on the window). A drop-down menu will appear. Select **Get Camera Control**.

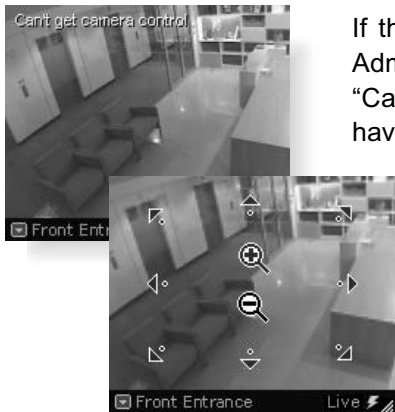

If the camera is being used by the Viewers or another VB Administration Tools associated with the Camera Server, a “Can’t get camera control” message will appear. You may have to wait a few moments and attempt to get control later.

Arrows will appear in the cursor position when you have gained control of the camera. When you move the mouse cursor over a Video Window, the mouse cursor changes its shape. Click and drag the cursor in the direction of the arrow for pan and tilt. When you move the mouse cursor to the center of the image, a zoom in or zoom out control will appear.

Hold down the mouse on “+” to zoom in.

Hold down the mouse on “-” to zoom out.

When you have finished, select **Release Camera Control** from the Video Window menu.



Tip

- If you have camera control, you can only drag the window by clicking and holding the title bar.
- When you have control, the camera can be controlled either by clicking or moving the mouse while holding the left button down. The latter method provides finer control.
- If a control warning “Control will be lost in 10 seconds.” appears, it means you have stopped making changes for 30 seconds and a 10 second countdown commences. To continue control, click in the Video Window, i.e. use the controls.
- You can still manipulate a camera that is currently recording. If the recording position has been set, the Camera Server will return to that position after the Viewer release camera control.

Using the Camera Control Panel

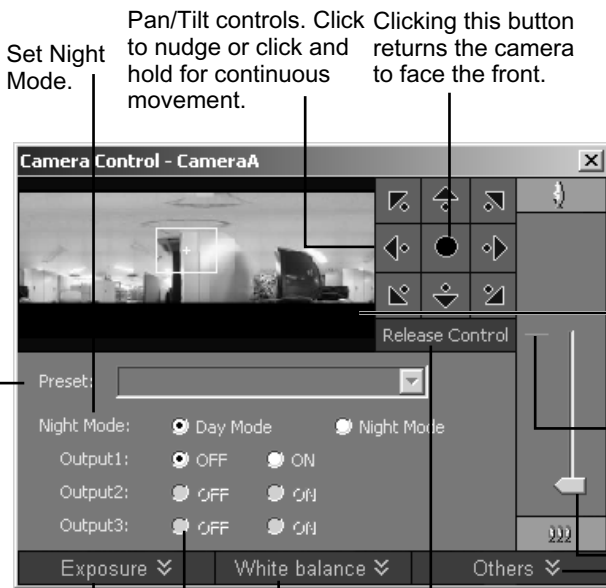

Set Night Mode.

Pan/Tilt controls. Click to nudge or click and hold for continuous movement.

Clicking this button returns the camera to face the front.

To display, select **View > Camera Control** from the menu bar, or click the Video window menu icon (or right-click in the Video Window) to bring up a context menu and select **Camera Control**.

If a Video Window is not selected, the preview window will be blank. Click on a Video Window to control the camera.

You can control the pan, tilt, and zoom operation using a panorama image. Click inside the Panorama window to adjust the pan and tile angles so that the clicked position becomes the center of the image. Alternatively, you can move or zoom in/out the yellow scope to perform the pan, tilt, and zoom operation.

If the digital zoom is enabled by the Camera Server, a boundary between the optical and digital zoom is displayed.

Click and drag the Zoom slider to perform the zoom operation.

Click this button to display extended camera control panel (→ P. 187).

Click this button to display exposure control (→ P. 186).

Click this button to display white balance control (→ P. 186).

When the Video Window is selected, click **Get Control**. Click **Release Control** when finished.

Switch On and Off of external device output of the camera.

If preset camera angles have been set up by your Administrator, they will be available from a drop-down menu.



Note

When using the VB-C300, you cannot use Night Mode in the following cases:

- When Day/Night is set to Auto on the Camera and Video Settings page
- When the Night Mode is set to Auto with a recording schedule

Exposure Control Items (when the Exposure Mode is Auto)

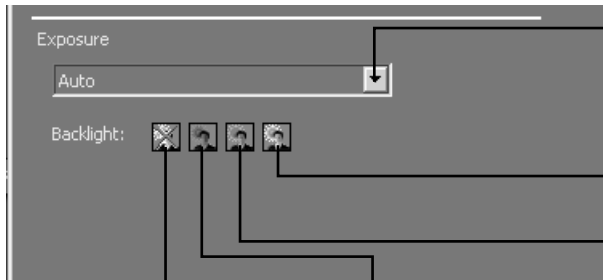

Set the Exposure Mode to **Manual** (VB-C300 only).

Auto: Automatically adjusts the exposure.

Clicking this button enables high-level backlight compensation.

Clicking this button enables mid-level backlight compensation.

Clicking this button disables backlight compensation.

Clicking this button enables low-level backlight compensation.

Exposure Control Items (when the Exposure Mode is Manual)

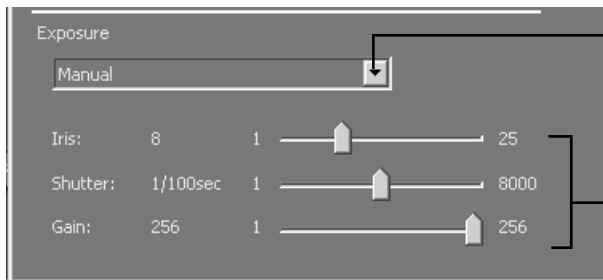

Set the Exposure Mode to **Auto** (VB-C300 only).

Manual: Dragging slide bars adjust the aperture value, shutter speed, and gain value.

Drag each slide bar to adjust the aperture value, shutter speed, or gain value.

White Balance Control Items

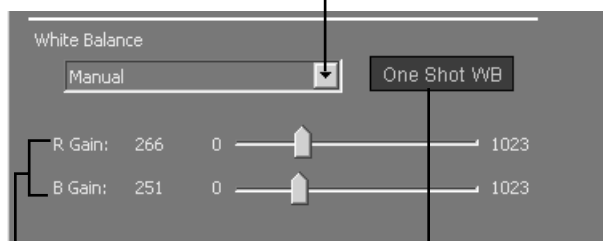

Select the White Balance mode from the drop-down menu. The following modes are available (VB-C300 only).

Auto: Automatically adjusts the white balance.

fluorescent:

Select this option when using the camera under a day-light or white fluorescent lamp.

fluorescent H:

Select this option when using the camera under a day-light fluorescent lamp.

Mercury lamp:

Select this option when using the camera under a mercury lamp.

Sodium lamp:

Select this option when using the camera under orange light of a sodium-vapor lamp.

Halogen lamp:

Select this option when using the camera under a halogen or incandescent lamp.

Manual: Drag each slide bar to adjust each gain value (R or B gain).

Drag each slide bar to adjust each gain value.

To forcibly adjust the white balance, capture a white object (e.g., a piece of white paper) and click **One-Shot WB**.

Other items

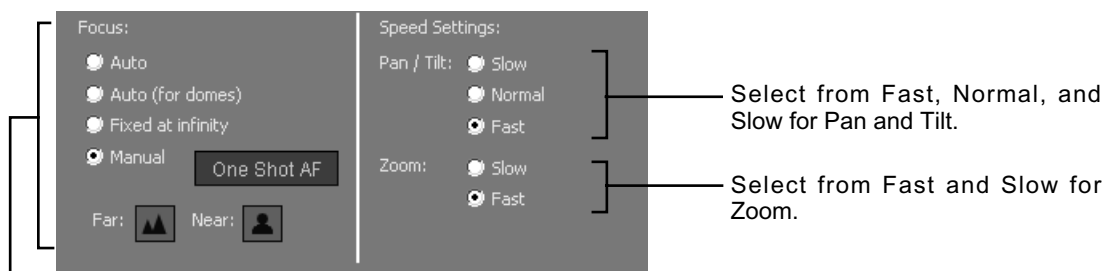

Switch between Auto Focus and Manual Focus.

Auto: Adjust the focus automatically.

Auto (for dome housing):

When the optional dome housing is used, select this option to automatically adjust the focus without focusing on the wall surface.

Infinity: Focus is fixed at a point of infinity.

Manual: Press and hold **Far** or **Near** button to adjust the focus. Clicking **One Shot AF** adjusts the focus just once automatically (VB-C300 only).



Note

- When you have finished, select **Release Camera Control** from the active **Video Window** menu.
- **Panorama** picture needs to be set on the **Camera Server** in advance. VB-C50FSi/VB-C50Fi cannot display **panorama** picture.
- **Exposure** can be adjusted for VB-C300 only.
- **White balance** can be adjusted for VB-C300 only.

Selecting a Preset Camera Angle

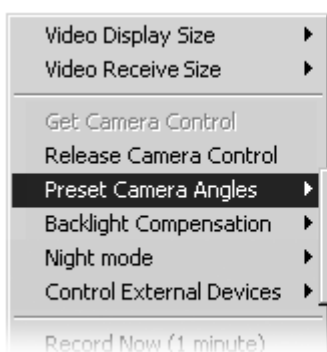

If preset camera angles have been set up and stored as presets, they will be available from the **Preset** drop-down menu of the **Camera Control** panel or a sub-menu. The following explains how to select a preset from a sub-menu.

- 1 Double-click a **Video Window** or select **Get Camera Control** from the **Video Window** menu.
- 2 From the **Video Window** menu, click **Preset Camera Angles**.
- 3 Select a preset position from the sub-menu.

■ Other Video Window Functions

Change the size of a Video Window

Apart from manually clicking on the corner and dragging out the Video Window to a new size, you can also select a set size from the Video Window menu.

To change the display size of a Video Window via the menu:

- **Open the Video Window menu and select Video Display Size.**



- 1 Click the Video window menu icon, or right-click in the Video Window to bring up a context menu.
- 2 Select **Video Display Size** from the menu, and then select **Small**, **Medium**, **Large**, or **Raw** from the sub-menu. A Raw selection displays the Video Window selected at the **Video Receive Size**.

Change the size of a Received Video (VB-C50i/VB-C50iR, VB-C50FSi, VB-C50Fi only)

You can select a video size received by the Viewer. To change the size of received video via the menu.

- **Open the Video Window menu and select Video Receive Size.**

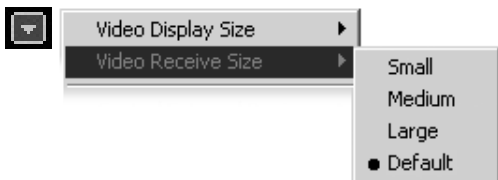

- 1 Click the Video window menu icon, or right-click in the Video Window to bring up a context menu.
- 2 Select **Video Receive Size** from the menu, and then select **Small**, **Medium**, **Large**, or **Default** from the sub-menu. Selecting **Default** displays the Video Window in the size received from the Camera Server.



Note

- When multiple Video Windows from a single Camera Server are displayed and the Video Receive Size is changed from one of them, the change will apply to all Video Windows.
- Selected video receive sizes are saved when the layout is saved.
- The Video Receive Size used for Default is determined when connection with Camera Server starts. Even if you change the size from the Camera Server after the connection is made, it will not apply.

Enabling Backlight Compensation

Backlight compensation is a camera feature used to compensate for camera views with strong backlighting, i.e., viewing a dark image against a strong backlight. It can be enabled from the Video Window menu. It is not to be confused with Shade Correction.

To enable backlight compensation:

- While Camera Control is active, select Backlight Compensation.



1 Click menu bar of the Video window, or right-click in the Video Window to bring up a context menu.

2 Select **Backlight Compensation** from the menu and select **Off**, or **On** from the sub-menu.

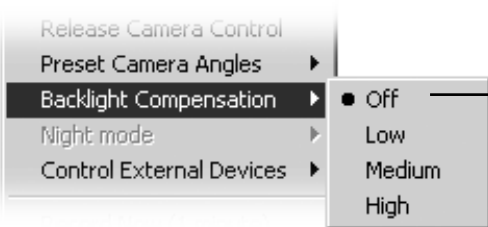

You can set the backlight compensation to **Off**, **Low**, **Medium** or **High** for VB-C300, VB-C50i / VB-C50iR, VB-C50FSi and VB-C50Fi.



Note

If High, Medium, or Low is selected, the tick (black dot) is not displayed.

Other Menu Options

Other functions available from the Video Window menu include:

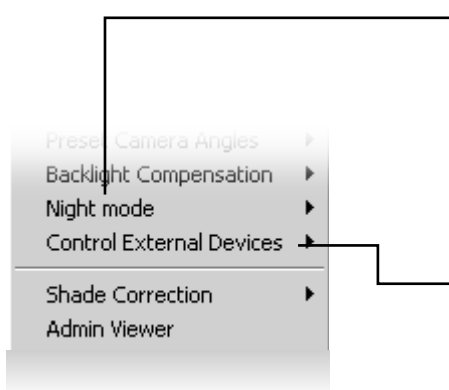

Click **Night mode** and select **Disabled**, **Enabled**, **IR light** off, or **Enabled**, **IR light on** from the sub-menu. Selecting **Enabled**, **IR light on** will remove the IR cut filter and turn the built-in IR light on. The IR light cannot be used with the VB-C300, VB-C50FSi, or VB-C50Fi.

Click **Control External Devices** to control any external devices that may be connected to your **Camera Server**. This is only enabled when you have camera control.

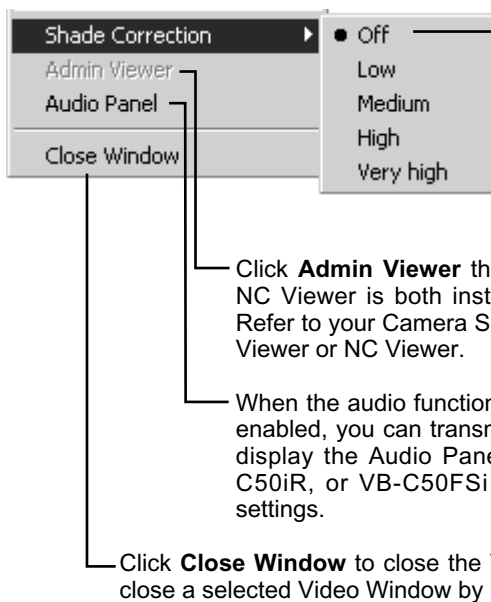

Click **Shade Correction** to correct shaded areas in the Video Window. This affects the individual Video Window on display, i.e., any duplicate (unselected) windows are not affected. This is discussed on the following page.

Click **Admin Viewer** the WebView Livescope Viewer if the Admin Viewer or NC Viewer is both installed. For the VB-C300, the NC Viewer is activated. Refer to your Camera Server User's Manual for more information on the Admin Viewer or NC Viewer.

When the audio function of the VB-C300, VB-C50i/VB-C50iR, or VB-C50FSi is enabled, you can transmit and receive audio. To use audio, click this menu to display the Audio Panel (→ P. 191). Refer to your VB-C300, VB-C50i/VB-C50iR, or VB-C50FSi User's Manual for more information on the audio settings.

Click **Close Window** to close the Video Window that is currently selected. You can also close a selected Video Window by pressing the Delete key.

 **Note**

- It is recommended to install the Viewer and/or NC Viewer in advance.
- The camera server which is sending or receiving audio cannot interact with other Viewer or Admin Viewers.
- Shade Correction cannot be applied to multiple Video Windows.
- Shade correction is performed by using image processing within the Viewer and not on the Camera Server. It can be used on live or recorded video (see below).

About Shade Correction

Shade Correction compensates darker regions of images and makes them lighter.



Shade Correction Off

Shade Correction High

Correction only applies to the displayed Video Window in the Viewer.

Darker regions are most affected by Shade Correction.

About Audio Panel

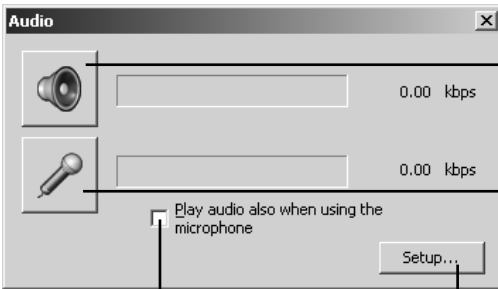

When ticked, audio is played back even when a microphone is used.

Click this button to display silent detection control.

Clicking this button after selecting a Video Window, or selecting a Video Window after clicking this button starts audio playback.

Clicking this button after selecting a Video Window, or selecting a Video Window after clicking this button starts audio transmission.

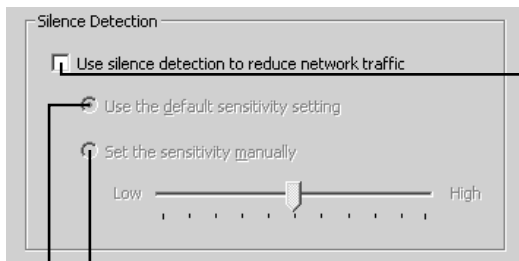

Tick this option to detect silent intervals with predefined sensitivity.

Tick this option to manually specify the detection sensitivity. Drag the slide bar to adjust the detection sensitivity.

When ticked, silent interval is detected while transmitting audio. For a silent interval, network load can be mitigated by reducing data to transmit.



Note

You cannot transmit and receive audio when using a proxy server.

Using the Timeline and Viewing Events

This chapter shows you how to use the Timeline for live and recorded viewing as well as view and search events.

Timeline Overview

On the Viewing Screen, a timeline of past events associated with displayed cameras is shown in the Timeline Area (→ P. 148) at the bottom of the Viewer as colored bars. Selecting a colored bar moves the playhead to the event and the associated Video Window is switched to playback mode.

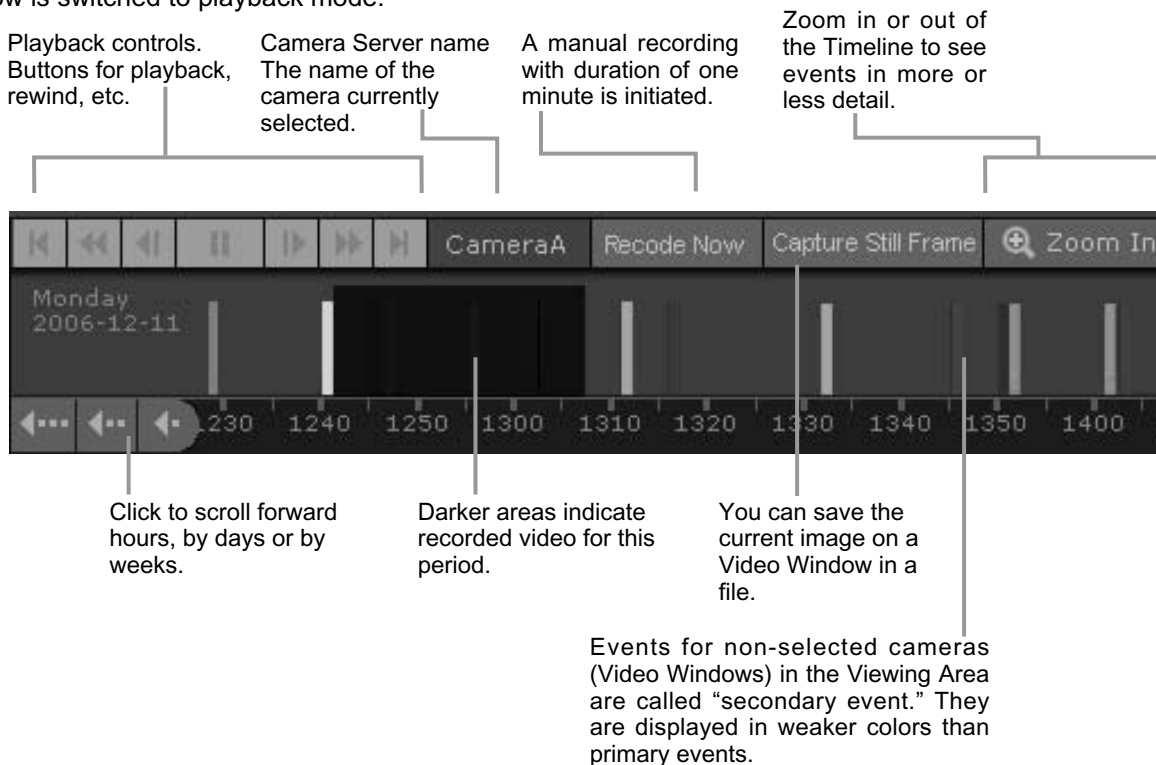

Playback controls



- Previous Event.
- Rewind.
- Nudge Back.
- Play/Pause.
- Nudge Forward.
- Fast Forward.
- Next Event.

Playhead region



Click in this area of the Playhead shaft and drag to positions on the Timeline.

Monitoring Live Video in relation to the Timeline

When a Video Window is created from a camera thumbnail, video is seen live. The Playhead (shown below) will be in a “live” position. The “live” position represents the present time. The playhead remain fixed as time scrolls to the left underneath, representing the passage of real time.

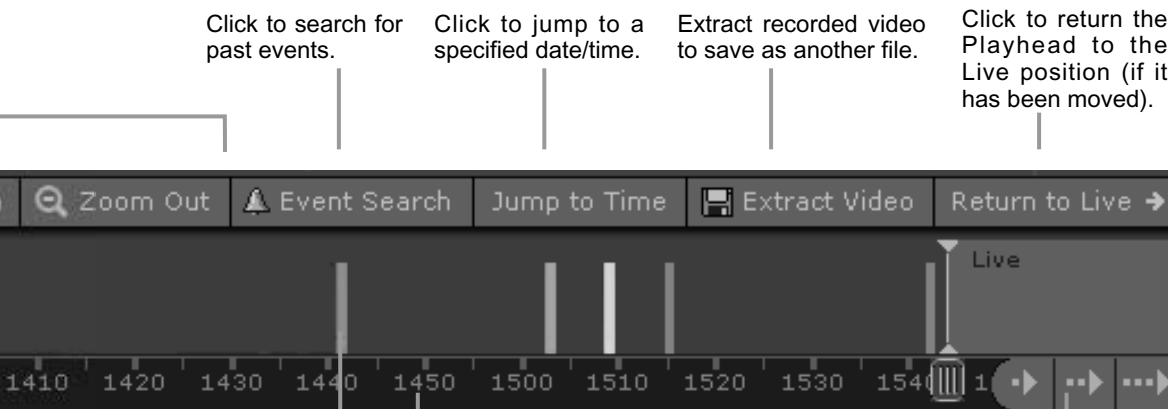

Click the time bar and drag to scroll through the Timeline.

Click to scroll forward hours, by days or by weeks.

Events associated with selected cameras (Video Windows) in the Viewing Area are indicated in stronger colors as primary events.

Event display area.

Day indicator.

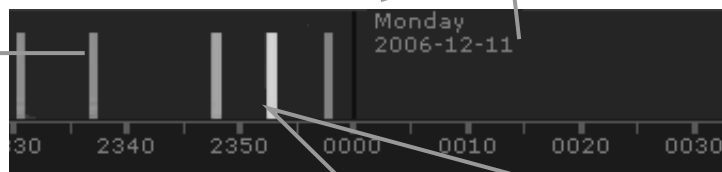

Priorities are color-coded as follows.

Color	Priority
Red	Highest
Orange	High
Yellow	Medium
Light Green	Low
Dark Green	Lowest



Note

If no cameras are selected, all events are shown as primary events.



Tip

You can hide the timeline by de-selecting Timeline from the View menu.

Using the Timeline to examine, play and extract video

You can view recorded video by moving the playhead control in the Timeline or entering a timecode and jumping to it. Methods include:

● Use the Playback Controls



You can control to play, rewind, fast forward or jump to previous and next events (→ P. 192).

The fast forward and rewind speeds change by 1x, 2x, 5x and 10x each time you click the buttons.



Tip

Videos recorded at different times can be played back simultaneously. First select a Video Window and move the Playhead to start playback. Next select another Video Window and move the Playhead to another time. This is ideal for comparing the same or different cameras at different times.

● Drag the Playhead to a new time

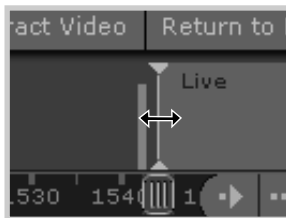

Click and drag the Playhead shaft to another location. When you move the Playhead, you are effectively controlling all Video Windows that have been selected.

● Click in the Event Display Area of the Timeline



Click in the Event Display Area of the Timeline. The Playhead will move to that location and playback of recorded video commences from that time.



Note

- **When you choose to play back video, the video is played over a network. Therefore the response and smoothness of the playback will depend on network traffic and other properties of the network.**
- **The time displayed on the Timeline is the time of PC where the Viewer is running.**

● Click and drag the time bar to move through the Timeline...



Move your mouse pointer over the time bar and it becomes a hand. Click and drag to the left or right to move back or forward in time. You can only scroll right to the current time, or “live” time.

● Jump to time entered

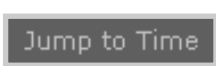

1 Select a Video Window and click **Jump to Time**.



2 The **Jump to Time** dialog opens. Select a day and/or time.

3 Click **OK**.
The Playhead and Timeline will move to the time selected. If no Video Windows are selected, only the timeline is moved.

Using the calendar is shown below.

Click to scroll back through the months.

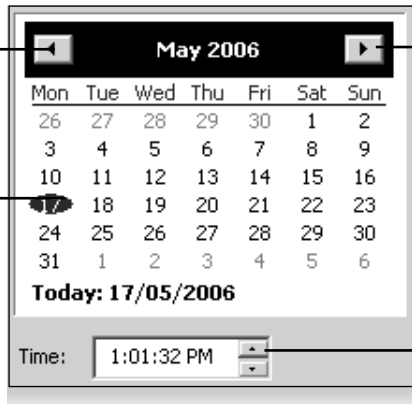

Click to scroll forward through the months.

Click a day to highlight it, then click **OK** to bring up that day in the Timeline.

Alternatively, click the current month and a month selector will appear.



Click up/down arrows to select a time or click each time segment and overwrite existing value.

To select another year, click the current year and scroll down or back up, using the up/down arrows.

Initiating a manual recording with duration of one minute

A manual recording with duration of one minute can be initiated at the maximum frame rate. The manual recording is displayed on the Timeline and **Live Events Log** as **Manual Rec.** *username*). This is handy for capturing random events not associated with sensor recording or outside preset recording times.

To initiate manual recording:



1 Select a Video Window for manual recording.

2 Click **Record Now**.



Note

- The Record Now function records at the maximum frame rate. Extended recording time will use additional disk space on the Storage Server.
- The Record Now function is only enabled if a Storage Server is configured for the camera.
- Recording will be for approximately one minute. The actual duration of recorded video may vary depending on settings and network delays.
- The priority of an event created by a manual recording using Record Now will always be Priority 1. It cannot be changed from Event Tab.

Shooting a Snapshot

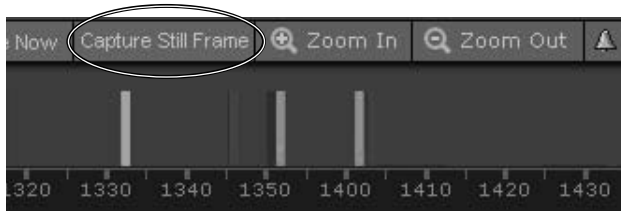

Click **Capture Still Frame** to keep the current image on a Video Window.

1 Select a Video Window to capture a still image.

2 Click **Capture Still Frame**.

Zooming In and Out of the Timeline



Click **Zoom In** to zoom into a time period in the Event Display Area.

Click **Zoom Out** to zoom out a time period in the Event Display Area.

Click event to select it

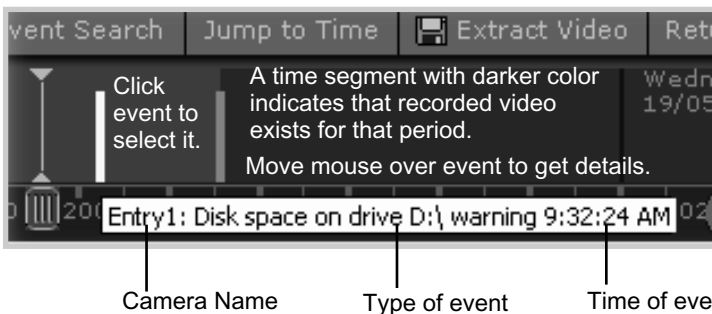

When you click an event to select it, the associated Video Window will display the event(s).

Daylight Savings Indicator

The Storage Server will adjust for Daylight Savings if configured in **Date and Time** property of the control panel as follows:

- When normal time has changed to Daylight Savings time, time that is skipped is displayed in the Timeline as missing.
- When gaining time (rewinding the clock back from 02:00 to 01:00), the extra time is duplicated.



Where Daylight Saving changes have occurred, the Timeline display is still continuous. Only the labels are affected.
Note

Extracting video to save to another location

A portion of video can be saved to another location if required. Files are automatically saved as QuickTime .mov format and can be viewed in a QuickTime player or any other player that supports .mov files. A maximum of one hour of video can be extracted at a time. If you do not have a QuickTime player installed, visit <http://www.quicktime.com> for a free download.

Select a Video Window and time period then click Extract Video.

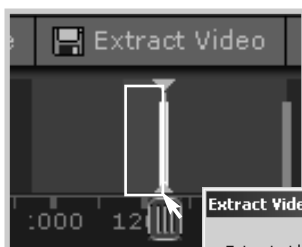

1 Click a Video Window to highlight it, then click and drag a time period for it in the Timeline.

2 Click **Extract Video**. The **Extract Video** dialog opens.



3 In the **Date:** field, click each segment and overwrite with desired date. Alternatively click the down arrow to use the calendar.

4 Click up/down arrows to select a time or click each time segment and overwrite existing value.

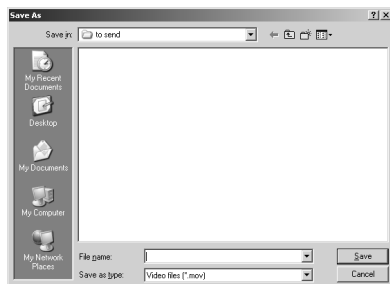

5 Click **OK** to display the **Save As...** dialog. The **Save As** dialog opens. Browse to a suitable folder in which to save the extracted video, and click **Save**.



Note

- You must select only one Video Window to extract video.
- QuickTime player version 6.5.1 or later is recommended.

Returning to Live Video

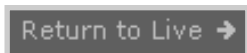

To return to the live video, click **Return to Live** →. The Playhead returns to the live position in the Timeline.

■ Viewing and Searching Events

About Live Events Log list

The **Live Events Log** displays events that have occurred with one or more cameras after the Viewer has been launched. Events are color coded according to priority. The **Live Events Log** opens automatically when you launch the Viewer, if left open in a previous session of VK-64/VK-16.

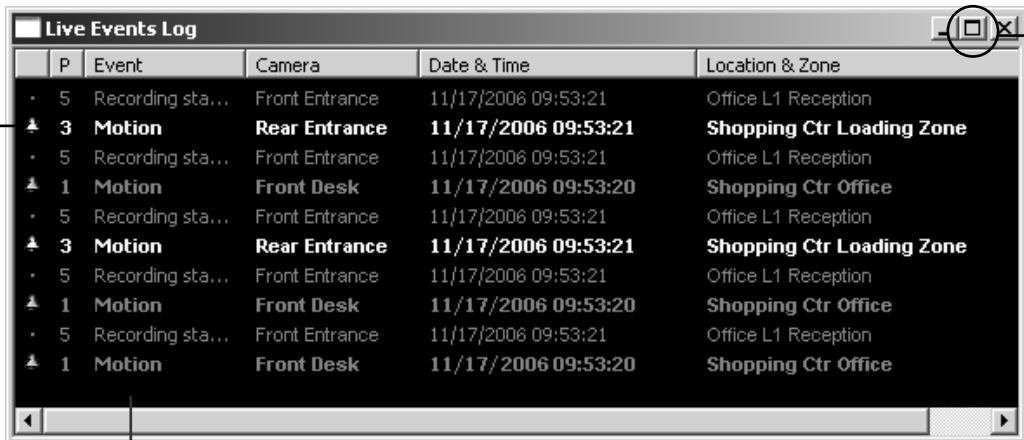

P	Event	Camera	Date & Time	Location & Zone
5	Recording sta...	Front Entrance	11/17/2006 09:53:21	Office L1 Reception
3	Motion	Rear Entrance	11/17/2006 09:53:21	Shopping Ctr Loading Zone
5	Recording sta...	Front Entrance	11/17/2006 09:53:21	Office L1 Reception
1	Motion	Front Desk	11/17/2006 09:53:20	Shopping Ctr Office
5	Recording sta...	Front Entrance	11/17/2006 09:53:21	Office L1 Reception
3	Motion	Rear Entrance	11/17/2006 09:53:21	Shopping Ctr Loading Zone
5	Recording sta...	Front Entrance	11/17/2006 09:53:21	Office L1 Reception
1	Motion	Front Desk	11/17/2006 09:53:20	Shopping Ctr Office
5	Recording sta...	Front Entrance	11/17/2006 09:53:21	Office L1 Reception
1	Motion	Front Desk	11/17/2006 09:53:20	Shopping Ctr Office

Click and drag scroll bar to view events.

To maximize, double-click title bar or click the maximize icon.

The bell icon is displayed when the event is acknowledged by double-clicking. Double-clicking the event to acknowledge it changes the icon to a dot.

Re-sizing the window to a custom size

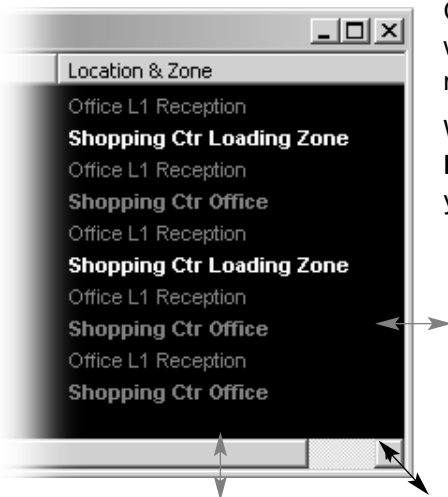

Click the corners or edges and drag the window out to a new size. Release the mouse button.

When you launch the Viewer again, the **Live Events Log** will retain the size you selected.



Note

Only the most recent 200 events are shown in the Live Events Log.

Displaying the Live Events Log List

To display the **Live Events Log** List:

Selecting Live Events from View Menu

From the VK-64/VK-16 menu bar, select **View** and **Live Events**.

Live Events Log list opens.

Once selected, the menu item will be ticked next time you display it.

Overview of Alert Parameters

P	Event	Camera	Date & Time	Location & Zone
5	Recording sta...	Front Entrance	11/17/2006 09:53:21	Office L1 Reception
3	Motion	Rear Entrance	11/17/2006 09:53:21	Shopping Ctr Loading Zone
5	Recording sta...	Front Entrance	11/17/2006 09:53:21	Office L1 Reception

Acknowledging and Viewing Events

A new event entry will appear at the top of the **Live Events Log** list and will flash for a defined period if configured. If Operator Acknowledgement is required, the event will flash indefinitely if not acknowledged.

- 1 In the **Live Events Log**, double-click on the event to acknowledge it and a recorded video at that time is displayed in its associated Video Window.
- 2 In the bottom right corner of the Viewer, click **Return to Live** → when you have finished viewing the event. The Video Window will return to live viewing.

Searching Events

If you have multiple events, you can initiate a search for a particular event via the **Event Search** dialog.

To launch the **Event Search** Dialog:

Click Event Search



On the Timeline, click **Event Search**.

The **Event Search** dialog opens.

Enter a search start date and time. Enter a search end date and time. Enter a keyword for particular events.

Select a Location and Zone.

Select a Priority.

Select a state of event.

Select a type of event.

Search Result Display Area

View Event in Camera Cancel

P	Event	Camera	Date & Time	Location & Zone
1	Door Open	Info Desk	8/23/06 12:55:35	Pitt Street Mall Checkout Area
3	Motion	Cash # 1	8/23/06 12:50:04	Pitt Street Mall 1st Floor
2	Door Bell	Entrance	8/23/06 12:40:46	Pitt Street Mall 1st Floor
3	Motion	Cash # 3	8/23/06 12:36:24	Pitt Street Mall Checkout Area
4	Motion	Cash # 3	8/23/06 12:20:09	Pitt Street Mall Food Court
3	Motion	Cash # 3	8/23/06 11:55:37	Pitt Street Mall G/F Lift Area
4	Door Bell	Entrance	8/23/06 11:52:23	Pitt Street Mall Food Court
5	Door Open	Entrance	8/23/06 11:52:15	Pitt Street Mall Checkout Area
1	Motion	Store Room	8/23/06 11:42:24	Pitt Street Mall Checkout Area
3	Motion	Cash # 3	8/23/06 11:38:30	Pitt Street Mall 1st Floor
5	Door Bell	Entrance	8/23/06 11:35:15	Pitt Street Mall Floor Court
2	Motion	Cash # 3	8/23/06 11:25:37	Pitt Street Mall Checkout Area

Double-click an event to view it in the Video Window, or click an event to highlight it and then click **View Event in Camera** to view it.

Selecting Criteria for Searching

When you initiate a search, certain criteria can be specified such as Priority, Location and Zone on the network, a date range when the event may have occurred and a time period.

To initiate a search:

Step 1: Select a date and time range to search

Click in the **From:** and **To:** date panels and overwrite the existing entries for month/day/year and time.

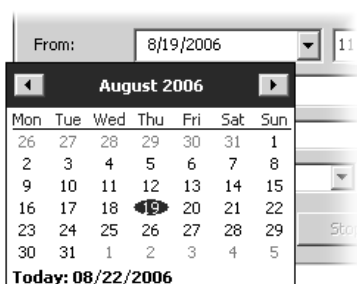

Alternatively, click the down arrow next to each date panel to bring up the calendar. Click off the calendar to close it again.

In the **Event Search** dialog, you can also scroll through time using the up/down arrows. Click an hours, minutes or seconds segment to highlight it and then click the up or down arrow.

Step 2: Select an event keyword



In the **Description:** field, enter a keyword such as, “deleting”, “recording”, “frames”, etc. Found events will be based on your text entry.

Step 3: Select a Location and Zone to search



From the **Where:** fields, select a Location and Zone from the drop-down lists.

Step 4: Select a type of Event

Event: All Events

Select a type of Event from the drop-down list.

Step 5: Select a State

State: All States

Select a State for the event, whether it was **On** or **Off** during the period. Alternatively, select **All States**.

Step 6: Select a Priority

Priority: All Priorities

Select a Priority from the drop-down list.

Step 7: Click Search

When you have entered the day and time range, click **Search** to initiate the event search. Events that are found will be listed in the window below. If necessary, stop a search at any time by clicking **Stop Search**.

Viewing found events

12:09	Pitt Street Mall	Food Court
12:55:37	Pitt Street Mall	G/F Lift Area
12:52:23	Pitt Street Mall	Food Court
12:52:15	Pitt Street Mall	Checkout Area
12:24	Pitt Street Mall	Checkout Area
12:38:30	Pitt Street Mall	1st Floor
12:35:15	Pitt Street Mall	Food Court
12:25:37	Pitt Street Mall	Checkout Area

View Event in Camera Cancel

To view an event in a Video Window, click the event to highlight it and click **View Event in Camera** to view it in a Video Window.

You can also double-click an event to view it in a Video Window.

Clicking **Cancel** stops any searching and closes the dialog.



Note

When you have finished viewing an event in a Video Window, click Return to Live → in the Timeline to return the Video Window to live viewing.

Chapter 6

Operation and Management

Chapter Overview

This chapter explains points to notice concerning the Storage Server when you operating and maintaining the network camera system, as well as guidelines for operating the system.

● **Health Check for Storage Server**

Explains VK event display messages and required counteractions.

● **Operation Guideline for Recording and Viewing**

Explains frame rates for recording and live viewing via the Viewer.

● **Operation Guideline for Sensor Event Recording**

Explains operation tips concerning the sensor event recording, including points to notice and counteractions against troubles.

● **Optimization of Motion Detection Recording (Index)**

Explains operation tips concerning the Motion Detection recording, including points to notice and counteractions against troubles.

Health Check for Storage Server

VK Events (Timeline for VK Viewer)

If any of the events listed in the table below occurs, you may have to take the specified counteraction.

The text within { } in each message depends on the situation.

Event type	Message	Description	Counteraction example
Indicates the free space on the disk	Indication (on) / recovery (off) {Drive Name} is running out of space: {Situation}	This event occurs when the disk free space has run under the specified value or the used disk space has exceeded the specified value. In this case, data may be deleted before the designated storage time elapses. Disk capacity indication is only effective when it is on.	Review the recording and Camera Server settings (→ P. 51, P. 98).
Starts and stops deletion due to space shortage. (*)	Start (on)/Stop (off) Deleting files on Drive {Drive Name} due to disk free space shortage: {Situation}	This event occurs when the disk free space has run under the threshold value or the used disk space has exceeded the threshold value.	
Pauses and resumes recording due to space shortage. (*)	Start (on)/Stop (off) Recording paused due to disk free space shortage on Drive {Drive Name}: {Situation}	This event occurs when the disk free space has run under the threshold value or the used disk space has exceeded the threshold value.	
Connection error to the Camera Server	Error occurrence (on) / recovery (off) Connection to host ({Camera Server Address}): {Port}: {Situation}	This event occurs when an error has occurred while connecting to the Camera Server. However, it does not necessarily occur for every connection failure. When this event occurs, the recording engine tries for reconnection and a COMM error occurs if the retry fails.	Review the network connection (→ P. 88).
Recording frame rate change	Effective recording rate ({recording rate before change} → {recording rate after change} %) Example: Ex. "Recording rate (100.0 > 90.0 %)" * This is not an On/Off event.	This event indicates that the recording frame rate has been reduced due to increased server load.	Review the recording settings or consider adding the Storage Server (→ P. 82).

For the items marked with (*), refer to "Disk Space Management <Important>" (→ P. 58).

Operation Guideline for Recording and Viewing

The following explains the automatic frame rate adjustment function for viewing and recording.

This function checks the load of the PC on which the Storage Server and the Viewer are running and adjusts the frame rate for video recording and live viewing.



Note

Using this function is recommended; however, make sure you perform tests under actual conditions before starting operations.

Live-View Frame Rate Adjustment

● Auto Adjust Frame Rate in the Viewer Settings (→ P. 157)

* This option is enabled by default (recommended).

When displaying live video, the Viewer requests the camera to send the video at the specified frame rate (→ Max. Live Frame Rate on P. 157).

If you use this function, you can maintain a stable display of live video with a temporarily lowered frame rate even if your PC temporarily becomes highly loaded for some reasons.

If you do not use this function, menu operation or display response may be affected when the load on your PC is high.

Recording Frame Rate Adjustment

Reduce recording frame rate when disk is under high load in the Storage Server Configuration dialog (→ P. 51)

* This option is enabled by default (recommended).

When the network recording software writes images received from cameras into the hard disk, if the load (mainly the load of writing into the hard disk) of the PC on which the Storage Server is running is too high, the software cannot write the images immediately.

If the amount of the image that is waiting to be written increases for a certain period of time, the Storage Server considers the PC to be highly loaded. When this happens, the Storage Server stores images at intervals rather than storing all of the images the Storage Server received, in order to reduce the PC load.

If you use this function, you can avoid recording failure as much as possible even if your PC temporarily becomes highly loaded for some reasons.

Note that events are generated when the network recording software starts and ends the operation of the function (→ P. 269, “Changing the Recording Frame Rate”). You can check the operating status of the function via the Event Search dialog (→ P. 201).

If you do not use this function, recording may be interrupted when the load on your PC is high. This software cannot detect the recording interruption.

Operation Guideline for Sensor Event Recording

Proper Operation of Sensor Event Recording (Optimization of Sensor Arrangement and Sensitivity)

Frequent sensor events result in high CPU load on your PC, and the recording frame rate may be reduced or recording may be interrupted. If you have 10 or more sensor events per minute continuously, we recommend continuous recording.

For each Storage Server, it is recommended to lower the sensor sensitivity or use continuous recording.

- 20,000 or more sensor events occur a day.
- 10 or more sensor events occur every minute.



Tip

Check the number of sensor events with the status bar.

Optimization of Motion Detection Recording (Index)

The Motion Detection recording is not suited to applications where high levels of reliability are required. Therefore, it is recommended to use continuous recording for monitoring or other purposes if consistently high levels of reliability are required. Canon accepts no liability whatsoever for faults, etc. resulting from the use of the Motion Detection recording.

Frequent motion detection events result in high CPU load on your PC, and the recording frame rate may be reduced or recording may be interrupted. If you have 10 or more motion detection events per minute continuously, we recommend continuous recording.

Frame Rate indicates the number of frames for Motion Detection recording. Lowering this value mitigates load on the Storage Server.



Tip

- **Longer before event recording with insufficient memory may lead to the use of disk-based virtual memory which will greatly reduce performance. Shorter before event recording will reduce memory usage.**
- **The full requested duration of post event recording may not be available due to data size and network delays.**

Motion Detection Setting for Each Camera Model

VB-C50i/VB-C50iR, VB-C50FSi, VB-C50Fi, VB150

Configure the Motion Detection settings on the Camera Server.

Please refer to the Camera Server User's Manual for details.

For the VB150, Video Input must be set to Single.

VB-C300

Configure the Motion Detection settings on the Storage Server.

Refer to “**Setting Motion Detection Recording**” (→ P. 118) for details on how to set the Motion Detection parameters.

Typically, set the total frame rate to 150 fps (e.g., 30 fps with five cameras) with the display resolution of QVGA.

Chapter 7

Backup Scheme

Chapter Overview

This chapter explains how to make backups for each purpose.

Since the volume of video data is the largest among various data types requiring backup, you must carefully choose backup equipment and learn the backup techniques.

Purpose of Backup

Purposes of backup include.

- Backup for Data Protection

Prevents data from system crash or hard disk failure. This type of back up targets video data, event data, and configuration files.

- Backup for Archive

Stores video data and event data on other media for a long period of time.

Preparation for Backup

About Backup Device

Prepare necessary equipment for backup depending on the data quantity of the VK-64/VK-16. Basically, you should use the DDS-4 type device if a single backup copies several Gigabytes through 40 GB of data, and DAT72 or AIT if it copies around 70 GB of data.

Further, if backup data quantity reaches 100 through 400 GB, you should use the LTO device. If you need more capacity or want to omit media replacement, you can consider auto loaders for the LTO device.

● Backup Example for VK-64/VK-16

If 10 Camera Servers record video for 30 days at 1 fps (10 KB)

the required data capacity is 300 GB per month, 70 GB per week, and 10 GB per day.

In this case, it is recommended to use the LTO device (Ultrium tape device). This type of device records 100 through several hundreds GB of data at the average transfer speed of 25 through 30 MB/sec (or 40 through 60 MB/sec when data is compressed).

The time required for making backup of data for 30 days (300GB) is approximately 12,000 seconds (i.e., 3.5 hours). The time is shortened to approximately 2.5 hours when data is compressed (Although the hardware specifications mention that the transfer speed will be doubled by compressing data, the expected compression ratio depends on data formats. Therefore, it is dangerous to think so).

The time required for making backup of data for a week (70GB) is approximately 2,800 seconds (i.e., a little longer than 46 minutes).

The time required for making backup of data for one day (10GB) is approximately 400 seconds (i.e., 6 minutes 40 seconds).

Notes: Recording does not stop while making a backup of data; however, the recording frame rate may be reduced from the specified value due to disk I/O load and CPU load.



Tip

Video data for VK-64/VK-16 is non-reversible compressed data. Compression process done by tape or other devices is not necessary.

About Backup Tool

It is recommended to use a third-party backup tool for Windows. Read the manual of the tool for deployment.

About Restore Server for Archiving

If the purpose of backup is archive, you must prepare a separate PC for the Storage Server to which data will be restored. This PC must have the same drive configuration (e.g., hard disk configuration). For example, if the source server's system drive is C and data storage drive is D, and video data drive is E, you must configure the PC with the same drive configuration. However, the hard disk capacity must be determined according to data to restore.

Files to Make a Backup

Storing Location of Recorded Data and Event data

Video data being recorded is saved in a temporary file (refer to “About Temporary File” below), and the file is settled and saved as video data when its size reaches 1 GB (by default) to the storage drive.

The recorded video data and event data are saved in the following folders according to your settings for **Save video in** and **Drive** when you register Camera Servers (→ P. 92).

Recorded Video data

Save video in: \WebView-NVR\videofiles

The following two file types are backed up:

File name =

NVR_INDEX_XXXXXXXXXXXXXXXX_YYYYMMDD_HHMMSS_YYYYMMDD_HHMMSS.MOV
Camera ID Recording start date_time Recording end date_time

File name =

NVR_MEDIA_XXXXXXXXXXXXXXXX_YYYYMMDD_HHMMSS_YYYYMMDD_HHMMSS.AVI



Note

These two files are used in pairs. Be sure to back up both files.



Tip

The recorded video data file name contains the Greenwich Mean Time as the time stamp.

● About Temporary File

File name = NVR_STANDBY_MEDIA_XXXXXXXXXXXXXXXX_YYYYMMDD_HHMMSS.AVI

File name = NVR_STANDBY_MEDIA_XXXXXXXXXXXXXXXX_YYYYMMDD_HHMMSS.AVI.TMP

File name = NVR_STANDBY_MEDIA_XXXXXXXXXXXXXXXX_YYYYMMDD_HHMMSS.MOV

These three files are not yet settled by the system.

● Recorded Data Concept

Video data being recorded is saved in a temporary file, and the file is settled and saved as video data when its size reaches 1 GB (by default) to the storage drive. This recording unit can be changed in the **Maximum file size/duration** field, in the **Storage Server Configuration** window's **Settings** tab (→ P. 51).

Temporary files cannot be backed up in the normal procedure.

Backup for Data Protection

About Backup

When making a backup of data for protection, you must back up the following data:

- Recorded video data ---- It is recommended to make an incremental backup of this data. Refer to P. 217 for the file names and storage location.
- Event data ----- It is recommended to make an incremental backup of this data. Refer to P. 218 for the file names and storage location.
- Configuration file ----- Usually, make a backup of the configuration file when the system is installed, and do it again each time you change the settings of the VK-64/VK-16. However, if doing so makes management complicated, you can perform a full backup every day. Refer to P. 218 for the storage location.

● Notes on Backing Up Recorded Video Data

Video data being recorded is saved in a temporary file. The temporary file cannot be backed up in the normal procedure. Refer to “Recorded Video Data” (→ P. 217) for details.

The temporary file cannot be backed up until it is converted into video data.

You should choose the backup hardware best suited for the backup data quantity. Basically, you should use the DDS type device if a single backup copies 1 through 10 GB of data, and AIT device if it copies 10 GB through 100 GB of data, and LTO device if it copies 100 through 400 GB of data. If you need more capacity, you need to consider multiple backup devices. Also, it is recommended to use a backup device with a high data transfer rate.

If the total capacity of the hard disk reaches several terabytes, you should rather consider, than making backups, using hot-spare hard disks or highly reliable storage system, or further reliable and available RAID system.

Backup for Archiving (Long-Term Storage of Data)

When making a backup of data for long-term archive, you must back up the following data:

- Recorded video data ---- It is recommended to make an incremental backup of this data. Refer to P. 217 for the file names and storage location.
- Event data ----- It is recommended to make an incremental backup of this data. Refer to P. 218 for the file names and storage location.
- Configuration file ----- Usually, make a backup of the configuration file when the system is installed, and do it again each time you change the settings of the VK-64/VK-16. However, if doing so makes management complicated, you can perform a full backup every day. Refer to P. 218 for the storage location.

● Notes on Backing Up Recorded Video Data

Video data being recorded is saved in a temporary file, and the file is settled and saved as video data when its size reaches 1 GB (by default) to the storage drive. The temporary file cannot be backed up in the normal procedure. Therefore, backup only the settled files. Refer to “Backup for Data Protection” (→ P. 219) for details.

When choosing the backup device, consider the backup unit. For example, if the backup unit is 100 through 400 GB, use a high-density tape device called “LTO device”. If it is around 2TB (far beyond 400 GB), consider LTO auto loader device.

Backup Procedure for Video Data and Event Data

Back Up Video Data and Event Data.

1

Estimate the total quantity of recorded video data for backup.

The video data quantity per day can be calculated as: Image file size per frame x Frame rate x Number of Camera Servers x Recording time (seconds) per day.

Refer to “Server Sizing Concept” (→ P. 29) for details.

2

Prepare the backup device and backup tool for Windows according to the estimated quantity.

3

Set up the backup tool as directed on P. 219 and P. 220.

Be sure to exclude the temporary files from the backup target.



Note

If the VK-64/VK-16 continues recording video while making a backup, you must take into account the increased I/O load on the hard disk due to data transfer to the backup device. If the recording frame rate of the Storage Server is reduced by performing the backup, consider the following:

- Lower the recording frame rate during backup in the Recording Schedule Setting window.
- Establish multiple I/O channels (e.g., RAID cards) on the Storage Servers to deploy multi-storage configuration and distribute the recorded video data among servers. Choose a backup device according to the storage configuration.
- Use multiple Storage Servers and use a dedicated backup device for each server. Refer to P. 28 for how to use multiple Storage Servers.

Restore Procedure

Restoring Data from Backup for Data Protection

The following explains how to reconstruct the Storage Server for the VK-64/VK-16 for maintenance or recovery from a failure.

- 1 Check that the PC hardware environment has been restored to the former state. Be sure to use the same folder organization as before.
- 2 Install the VK-64/VK-16.
- 3 After installation completes, stop the Storage Server from the **Storage Server Configuration** window.
- 4 Restore the VK-64/VK-16's configuration file to the former location. The default location is as follows:
<System Drive>: \Documents and Settings\All Users\Application Data\Canon\WebView\NVR\
- 5 Restore the recorded video data file to the former location. The default location is as follows:
<Save video in>: \WebView-NVR\videofiles
- 6 Restore the event data file to the former location. The default location is as follows:
<Save video in>: \WebView-NVR\eventfiles
- 7 Start the Storage Server from the **Storage Server Configuration** window.
- 8 Check that the recording operation is performed correctly. Also check that restored video data is played back correctly.



Note

If the Maximum retained history setting is used in the Storage Server Configuration window and the restored video data contains data exceeding the retaining period, that data will be deleted when the Storage Server starts.

Restoring Data from Backup for Data Archiving

The following explains how to restore only necessary files from the data backup for archive.

- 1 Check that the drive configuration of the PC to which the files are restored is the same as the PC from which the files were backed up.

Be sure that the hard disk has a capacity larger than the total size of the video data files to restore.
- 2 Install the VK-64/VK-16.
- 3 Restore the VK-64/VK-16's configuration file to the former location. The default location is as follows:

<System Drive>: \Documents and Settings\All Users\Application Data \Canon\
WebView\NVR\

4 Uncheck the Maximum retained history option in the **Storage Server Configuration** window.
- 5 Launch the Viewer and delete all the schedules for all the Camera Servers in the **Recording Schedule** tab under the Settings screen.
- 6 After deleting schedules, stop the Storage Server from the **Storage Server Configuration** window.
- 7 Restore video data files matching the date and time you want to play back to the former location. The default location is as follows:

<Save video in>: \WebView-NVR\videofiles
- 8 Restore event data files matching the date and time you want to play back to the former location. The default location is as follows:

<Save video in>: \WebView-NVR\eventfiles
- 9 Start the Storage Server from the **Storage Server Configuration** window.
- 10 Also check that restored video data is played back correctly.

Notes on Restoring Data from Backup for Data Archiving

- Restoring the configuration file also restores the old recording setting information. After restoration, the PC may start recording video according to the old recording schedule. If you do not want to record video, delete the recording schedules after restoration.
- If the Maximum retained history setting is used on the Storage Server, uncheck this option. If this option is enabled, the past data may be lost.

Examples

Configuration 1: Backup for Data Protection 1

Premise

5 VB-C50i

Recording condition

Frame rate is 1 fps (one frame per second), Camera Server video quality is 50, resolution is 320x240, the size for one image data is 15 KB.

The **Maximum file size/duration** option in the **Storage Server Configuration** window is set to six hours.

Under this condition, the video file size per Camera Server per day is 310 MB x 4 files.

Therefore, the video data quantity per Camera Server per day is 1.25 GB and 6.25 GB for five Camera Servers.

Hardware requirement

6.25 GB per day x 30 days = 190 GB Hard disk capacity of around 240 GB is required.

If the storage period of video data on the Storage Server is 30 days, an archive backup for 1-week data can be saved on 50-GB tape with an AIT drive. To save 30-day data on a single cassette of tape, a 200-GB LTO drive is necessary.

Configuration 2: Backup for Data Protection 2

Premise

10 VB-C50i

Recording condition

Frame rate is 1 fps (one frame per second), Camera Server video quality is 50, resolution is 320x240, and the size for one image data is 15 KB.

The **Maximum file size/duration** option in the **Storage Server Configuration** window is set to six hours.

Under this condition, the video file size per Camera Server per day is 310 MB x 4 files.

Therefore, the video data quantity per Camera Server per day is 1.25 GB and 12.5 GB for ten Camera Servers.

Hardware requirement

12.5 GB per day x 30 days = 375 GB Hard disk capacity of around 450 GB is required.

If the storage period of video data on the Storage Server is 30 days, and the required archive period is 180 days, an archive backup for 1-week data can be saved on 100-GB tape with an LTO drive (Ultrium). If you use a 400-GB LTO drive, you can save 30-day data on a single cassette of tape.

Configuration 3: Backup for Data Archiving

Premise

5 VB-C50i

Recording condition

Frame rate is 1 fps (one frame per second), Camera Server video quality is 50, resolution is 320x240, and the size for one image data is 15 KB.

The **Maximum file size/duration** option in the **Storage Server Configuration** window is set to six hours.

Under this condition, the video file size per Camera Server per day is 310 MB x 4 files.

Therefore, the video data quantity per Camera Server per day is 1.25 GB and 6.25 GB for five Camera Servers.

Hardware requirement

6.25 GB per day x 30 days = 190 GB Hard disk capacity of around 240 GB is required.

If the storage period of video data on the Storage Server is 30 days, and the required archive period is 180 days, an archive backup for 1-week data can be saved on 50-GB tape with an AIT drive. If you use a 100-GB LTO drive, you can save 1-week backup data.

However, if the tape capacity for archive is too large, it takes too long to find desired data to restore.

Configuration 4: Backup from Multiple Storage Servers (Backup for Data Protection)

Premise

100 VB-C50i

Recording condition

Frame rate is 1 fps (one frame per second), Camera Server video quality is 50, resolution is 320x240, and the size for one image data is 15 KB.

Twenty Camera Servers are registered in five Storage Servers to record video.

The **Maximum file size/duration** option in the **Storage Server Configuration** window is set to six hours.

Under this condition, the video file size per Camera Server per day is 310 MB x 4 files.

Therefore, the video data quantity per Camera Server per day is 1.25 GB and 25 GB for twenty Camera Servers.

Hardware requirement

25 GB per day x 30 days = 750 GB Ten servers is required (for each Hard disk capacity of 900 GB or more).

In this case, it is ideal to prepare one backup device for each server for backup. If you use a 400-GB LTO drive, you can save 2-week data on a single cassette of tape. Alternatively, you can prepare two or three servers dedicated for backup, and use network backup for central management.



Chapter 8

System Maintenance

Overview of This Chapter

This chapter describes upgrading and reinstalling of VK-64/VK-16 as well as how to restore previous versions of these software components. It also describes how to update the Camera Firmware.

Upgrading VK-64/VK-16

This section describes how to upgrade previous versions of VK-64/VK-16.

Upgrading from Version 1.0

- 1 Obtain the released version of v1.3 (you cannot use the upgrade program).
- 2 Back up the following folders that are in the Storage Server of v1.0.
 - <Installation folder for VK-64> \NVR\1.0\conf
 <<Example>> C:\Program Files\Canon\Webview\NVR\1.0\conf
 - <All drives> :\\WebView-NVR"Please note that the capacity of this folder is large.
- 3 Install the new version.
If a failure occurs, restore the previous version by following "Procedure for Restoring Previous Version" (→ p. 233).

Upgrading from Version 1.1 and 1.2

- 1 Obtains the v1.3 upgrade program (free program).
Available from: canon.com/webview
- 2 Back up the following folders that are in the Storage Servers of v1.1 and v1.2.
 - <Startup drive for OS> :\\Documents and Settings\\All Users\\Application Data\\Canon\\Webview\\NVR
 - <All drives> :\\WebView-NVR"
- 3 Install the new version by following the upgrade procedure described at our WebView Product web page.
If a failure occurs, restore the previous version by following "Procedure for Restoring Previous Version" (→ p. 233).

Reinstalling VK-64/VK-16

You cannot reinstall the software if you use the upgrade program.

When You Have the Released Version

- 1 Uninstall v1.3.
- 2 Obtains the v1.3 upgrade program (free program).
Available from: canon.com/webview
- 3 Back up the following folders that are in the Storage Servers of v1.1 and v1.2.
<Startup drive for OS>:\Documents and Settings\All Users\Application Data\Canon\Webview\NVR

<All drives> :\WebView-NVR
- 4 Install the new version by following the upgrade procedure described at our [WebView Product web page](#).

If a failure occurs, restore the previous version by following “Procedure for Restoring Previous Version” (→ p. 233).

When You Do Not Have the Released Version 1.3

- 1 Uninstall v1.3.
- 2 Install the previous version.
- 3 Execute the v1.3 upgrade program.



Tip

When You Want to Perform the Full New Installation

If you have removed the application from Add or Remove Programs in the Control Panel, the application folder, including its setting files and recorded data, remains undeleted. To delete all these files, delete all the following folders.

- <System drive> :\Program Files\Canon\Webview\NVR
- <System drive> :\Webview-NVR (storage folder for recorded and event data)
- <System drive> :\Documents and Settings\All Users\Application Data\Canon\WebView\NVR (storage folder for setting files)

Procedure for Restoring Previous Version

Required Media and Data

Make sure that you have the installation CD, patch installer and backed-up data for the previous version.

1 Remove **Canon Network Video Recorder VK Series v1.3** from **Add or Remove Programs** in **Control Panel**.

2 Delete the following folders.

<Startup drive for OS>:\Documents and Settings\All Users\Application Data\
Canon\Webview\NVR

<All drives> :.\WebView-NVR

3 Install the previous version by using the installation CD and patch installer for the previous version.

4 Stop the Storage Server in the Storage Server configuration.

Quit the Viewer.

5 Replace the existing folders with the following backed-up data.

Restoring Version 1.1 and 1.2

<Startup drive for OS>: \Documents and Settings\All Users\Application
Data\Canon\Webview\NVR

Restoring Version 1.0

<Installation folder for VK-64/VK-1> \NVR\1.0\conf

<<Example>> C:\Program Files\Canon\WebView\NVR\1.0\conf

6 Replace Start the Storage Server.

Updating Camera Firmware

The information concerning firmware can be obtained for free on the following Canon Web site: canon.com/webview

Procedure for Updating Camera Firmware (VB-C50 series)

To update firmware:

- 1 Obtain the latest firmware including the firmware update tool as well as backup and restore tools for configured values.
- 2 Save the values configured in the Camera Server by using the backup tool for configured values.
- 3 Perform the Firmware update by using the firmware update tool.

If a failure occurs in step 3, restore the settings by using the restore tool for configured values.

canon.com/webview

Chapter 9

Troubleshooting

Overview of This Chapter

This chapter explains the chart of countermeasures against failures, measures to be taken when a trouble occurs (troubleshooting), error messages, and log files.

Troubleshooting for Recording

When a recording trouble occurs when playing back recorded video data (e.g., data is not found), you can guess the cause by checking the Event Logs of the VK-64/VK-16 and Storage Server Log (re_log) .

Log		Cause		Countermeasure
Event	Storage Server	Error No.	Description	
Connection to <Camera Server's IP address> error: Error occurred (<Error No.>: <Description>) Ex. Connection to 192.168.100.1 error: Error occurred (10060: Connection time-out)	ERROR (connect) : socket type=(IMAGE/EVENT/COMMAND), cameraserver= (<host>:<port>) win32_error= (<Winsock Error Code>:<Error Message>)	10050	Network may be out of service.	Check the network (HUB, cables, etc.) for any problem and confirm that the Camera Server is operating normally.
		10054	A Camera Server's network problem or session disconnection due to Camera Server's reboot has occurred.	
		10060		
		10061		
		10064		
Effective recording rate (<Recording rate before change> → <Recording rate after change> %) Ex. Effective recording rate (100→90.0%)	Camera <camera> Effective recording rate (y%→z%) If the following message is also recorded, a large amount of captured data may have been discarded: <ul style="list-style-type: none"> · Camera <camera>: <x>/<y> frames discarded due to busy frame queue in last 1 minutes. 	The effective recording rate is too low (below 50 %). <ul style="list-style-type: none"> · Sensor and motion detection events occur too frequently, exceeding the standard given by the guideline. · CPU load of the Storage Server PC may be high. 	<ul style="list-style-type: none"> · Adjust the recording schedule and sensitivity of motion detection. · Check the CPU usage and terminate any applications which are putting heavy loads to the CPU. 	
N/A	Camera <camera>: <x>/<y> frames discarded due to busy drive thread in last 1 minutes.	Load due to writing recorded video data onto HDD may be too high.	Use the Windows' Performance Monitor to check the writing status of HDD. Review the recording schedule or add servers as required.	
N/A	Camera <camera>: <x>/<y> frames discarded due to busy frame queue in last 1 minutes.	CPU load of the Storage Server PC may be too high.	<ul style="list-style-type: none"> · Use the Task Manager to find out the application causing the problem. · If the VK-64/VK-16 module (AE.EXE) is causing the problem, the event generation frequency may be too high. Try the following: <ul style="list-style-type: none"> - Shorten the Maximum retained history setting for the recorded data - Reduce the number of events to generate - Add servers to distribute the load. 	
N/A	Error writing frame for camera <camera>: <error message> If the following messages are also recorded, a large amount of captured data may have been discarded: <ul style="list-style-type: none"> · Camera <camera>: <x>/<y> frames discarded due to busy frame queue in last 1 minutes. · Camera <camera>: <x>/<y> frames discarded due to busy drive thread in last 1 minutes. 	<ul style="list-style-type: none"> · The specified drive may be unable to be written. · The time setting of the VK-64/VK-16 Storage Server PC may have been changed to the past (in the NTP operation environment). 	<ul style="list-style-type: none"> · Check the drive for recording video data. · If you are using NTP to adjust time, shorten the synchronization interval with NTP (e.g., 7 days → 1 day). 	
Recording to E:\drive is on standby due to shortage of free HDD space.	No Storage Server Log	Load due to writing recorded video data onto HDD may be too high.	Shorten the Maximum retained history or add HDD. Also, review the recording schedule.	

VK Troubleshooting

Viewing Screen and Video Windows

This section describes how to solve problems that may occur when you are using VK-64/VK-16.

- Some of the thumbnails are not showing in the Camera Selection Area.

Situation You do not have enough thumbnails on display to make the scrollbar appear, but some of the thumbnails that were displayed before are no longer shown.

Solution Most likely you have selected another Zone or Location from the drop-down menu that is further down the list and the thumbnails have been scrolled to the left to show the selected Zone (→ P. 148). Check the selected Location and Zone.

- Cannot Pan, Tilt or Zoom a Camera Server in a Video Window.

Situation You have clicked a Video Window to get Camera Server control, but the shape of the mouse cursor is not changed to operate the Camera Server.

Solution Double-click the Video Window or select **Get Camera Control** from the Video Window menu (→ P. 184). Alternatively, check whether recorded video is not being played. If video is being played, the title bar of the Video Window will be gray, not black (→ P. 183).

- The **Record Now** feature is gray and disabled in one Video Window menu, however it is enabled in other Video Window menus.

Situation You have clicked a Video Window to display a Video Window menu and Record Now is gray (disabled). However, other Video Windows have the function enabled.

Solution Check if a Camera Server in the Video Window has the setting that disables recording (when the Camera Server was configured, **Do not Record** was selected).

- Layouts set up by another user cannot be seen.

Situation In the **Organize Layouts & Layout Sequences** dialog, you have clicked in the **Personal Layouts** folder in order to open a Layout created by another user.

Solution Layouts saved in the Personal Layouts folder cannot be seen by other users. To show a created Layout to all users, it should be created by a user with Administrator privileges and saved to the Shared Layouts folder (→ P. 162).

- Live and recorded video is not good quality (this does not relate to Resolution).

Situation In a Video Window, the live video quality is lower than that of another Video Window and recorded video (when you play back video) is also not good quality.

Solution The quality of live and recorded video cannot be changed in VK-64/VK-16. The video quality may vary from one Video Window to another because of Camera Server settings. The quality can be changed to a higher one in the admin screens of Camera Servers.

- Recording cannot be performed.

Situation1) Recording cannot be performed by all of the network cameras.

Situation2) Recording cannot be performed by a certain network camera.

Solution In the case of 1), check the following:

- The network cable of the server is plugged in.
- The power has not gone down.
- Do not Record is not specified in the Special Day Schedule settings and others.
- Link lamps on the hub (switch) and on the network connector for the server are on.
→If the lamps are off, there may be defects in the cable, hub (switch), or network connector for the server.

In the case of 2), check the following:

- The power source of the Camera Server and the network have no problem.
- The ping command succeeds for the network camera.
- You can view live video of the Camera Server by using a PC Viewer or NC Viewer and others.
- Do not Record is not specified in the Special Day Schedule settings and others.
- Sensor recording or motion detection recording is not set.

- Cannot log into a Storage Server from a Viewer.

Situation You cannot log into a Storage Server from a Viewer.

Solution Check the following:

- The login user name and password are correct.
- The network between the server and the Viewer has no problem.
- The IP address of the server to which you want to login is correct.
- The ping command succeeds for the server from the Viewer.
- When the proxy is configured in Internet Explorer, change the settings to exclude the VK server.

- Cannot view live video.

Situation You cannot view live video.

Solution Check the following:

- If “Could not connect to camera” is displayed in the Video Window, check whether the power source of the Camera Server and the network have no problem.
- An error is displayed in the Timeline in the Viewer.
 - If “Connect to <Camera Server IP Address>: Error Occurred” is displayed, check whether the power source of the Camera Server and the network have no problem.
- The screen goes black when layout is switched, but video is displayed after a few seconds.
 - Too many Camera Servers that exceed the performance of your PC are displayed in the Viewer, or a live frame rate that exceeds the performance of your PC is set. Reduce the number of Camera Servers to be displayed, or decrease the live frame rate.

- When a layout sequence is running in the Viewer, the Video Window suddenly goes black and video of the Camera Server cannot be displayed.

Situation When a layout sequence is running, the Video Window goes black and video of the Camera Server cannot be displayed.

Solution When many Camera Servers are placed in one layout and a layout sequence is run in a short time, system resources required for communication may run short. Reduce the number of Camera Servers to be displayed in a layout, or make the switching interval for layout sequences longer.

- Viewer operation seems to slow down.

Situation Viewer operation slows down.

Solution The performance of a Viewer depends largely on CPU specifications and graphics specifications of the PC on which the Viewer is installed. When Viewer operation slows down, try to reduce the number of Camera Servers to be displayed or decrease a live frame rate. If the video quality of Camera Servers is set high or the resolution is set to VGA, processing may take a long time because the size of image data is large. In this case, review the video quality or video size in the Camera Server settings.

Timeline

- The Playback controls are inactive.

Situation You have clicked any of the Playback controls but nothing happens.

Solution Move the Playhead away from the Live position. Playback controls will then be active. A Video Window needs to be selected for playback. Also, the nudge buttons (→ P. 194) and the **Extract Video** button (→ P. 198) are enabled only when one Video Window is selected.

Extracting Video

- Cannot save video as no data could be found.

Situation You have attempted to extract video, but an error message appears stating that no video can be found in the selected segment.

Solution Check that the selected segment of video has recorded footage (→ P. 192).

Scheduling and Recording

- Cannot initiate **Record Now** on a camera.

Situation You have selected a Video Window to initiate **Record Now**, but the menu option is not available.

Solution In the **Edit Camera Server** dialog of the **Configuration and Preferences** screen, **Do not Record** is probably set for the Camera Server. Change the option to enable recording to the Storage Server (→ P. 89).

- Cannot configure the Camera Server not to record.

Situation You have attempted to modify the Camera Server and set **Do not Record** in the **Edit Camera Server** dialog. A message appears stating that the Camera Server is already set up without recording settings.

Solution In the Camera Server list displayed on the **Locations/Zones** tab of the **Storage and Camera Server Summary** screen, the selected Camera Server probably has more than one listing. Click the listing which has an associated Storage Server listed beside it and then click **Remove Camera Server**. Make sure you save your changes to permanently remove the deleted Camera Server.

- Storage Server free disk space is extremely low.

Situation Storage Server disk usage is far in excess of the calculated level (→ P. 58) and there is little free space.

Solution When the Camera Server video quality is set high, there is a large amount of data per frame. Also, if you are using anti-virus software, communication between Storage Servers and Camera Servers is being recorded and that file may be several gigabytes in size. Please alter the anti-virus software settings to eliminate Storage Servers from virus scanning targets.

Connection Issues

- Cannot connect to a Camera Server.

Situation In the Viewer the screen has gone black and a message appears stating “Could not connect to camera”.

Solution Check whether the network is down, whether the physical connection to the Camera Server is broken, or whether the camera is not powered.

- Cannot connect to a Master Storage Server.

Situation You have attempted to launch the Viewer and a connection to the Master Storage Server error message appears.

Solution Check whether the specified Master Storage Server works properly. On the Storage Server computer, open the **Storage Server Configuration** utility. If the Storage Server is not running, click **Start Storage Server** (→ P. 55).

- The **Configuration and Preferences** screen takes a long time to open.

Situation When you switch from the Viewing Screen to the **Configuration and Preferences** screen, a message “Please wait...” appears and remains on screen for a while.

Solution Check whether you do not have a lot of Camera Servers to disconnect. Waiting time is dependent on the time required for disconnecting from each Camera Server on the network. It is recommended that you remove non-essential or low priority Camera Servers from your Viewing Screen.

- Fails to connect to Storage Servers when switching to the **Configuration and Preferences** screen.

Situation You have attempted to switch to the **Configuration and Preferences** screen and an error message appears stating a failure to connect to a particular Storage Server (name), although it can still connect to the Master Storage Server.

Solution Check whether the specified Storage Server works properly. A network error may have caused this situation.

Configuration Issues

- Cannot switch to the **Configuration and Preferences** screen.

Situation You have attempted to switch from the Viewing Screen to the Configuration and Preferences screen and an error message appears.

Solution Only Administrators can access the **Configuration and Preferences** screen. Check whether you have Administrator privileges.

- Camera Servers are not displayed in the **Camera Summary** window.

Situation In the list of Camera Servers on the **Camera Summary** window, some of the Camera Servers are not displayed.

Solution Only Camera Servers associated with the item selected on the **Storage Server** tab or the **Locations/Zones** tab will be shown in the list. Also, if you have the **Storage Server** tab displayed, Camera Servers configured as **Do not Record** will not be shown.

List of Messages

Operation Messages and Error Messages

Error messages and operation messages displayed during normal recording and operation of VK-64/VK-16 are shown below.

Storage Server Configuration Error Messages

	Messages	Cause
Event notification	The address of the recipient contains an invalid character.	A character other than alphanumeric characters and underscore (_) was entered in the address of the recipient.
	Specify the address of the recipient.	The address of the recipient was not entered.
	The address of the sender contains an invalid character.	A character other than alphanumeric characters and underscore (_) was entered in the address of the sender.
	Specify the address of the sender.	The address of the sender was not entered.
	The host name of the SMTP server contains an invalid character.	The host name of the SMTP server contains an invalid character.
	Specify the host name of the SMTP server.	The host name of the SMTP server was not entered.
	Specify the port of the SMTP server using a number in the range of 1 to 65535.	The port number of an invalid SMTP server was used.
	Specify the user name using 1 - 100 characters.	The user name was out of the valid number of characters range (This includes when the user name was not entered).
	The user name contains an invalid character.	An invalid character was entered in the user name.
	Specify the password using 1 - 20 characters.	The password was out of the valid number of characters range (This includes when the password was not entered).
The password contains an invalid character.	An invalid character was entered in the password. Only alphanumeric characters and underscore (_) can be used.	

	Messages	Cause
Event notification	The host name of the POP server contains an invalid character.	An invalid character was entered in the host name of the POP server.
	Specify the host name of the POP server.	The host name of the POP server was not entered.
	Specify the port of the POP server using a number in the range of 1 to 65535.	The port number of an invalid POP server was used.
User management	This user name cannot be used because it already exists.	An attempt was made to add a user in the Storage Server by using a user name that is already registered.
	The user name contains an invalid character.	An attempt was made to add a user by entering a user name that contains a character other than alphanumeric characters and underscore (_).
	The password contains an invalid character. Only alphanumeric characters and underscore (_) can be used.	An attempt was made to add a user by entering a password that contains a character other than alphanumeric characters and underscore (_).
	The password (confirmation) does not match.	An attempt was made to add a user by entering a password in the Confirm Password field, which does not match the entered password.
	Are you sure you want to delete this user?	An attempt was made to delete the user.
Configuration	Specify the Storage Server name using 1 - 20 characters.	The Storage Server name was out of the valid number of characters range (This includes when the Storage Server name was not entered).
	Specify the host name of the proxy server.	The host name of the proxy server was not entered.
	The host name of the proxy server contains an invalid character.	The host name of an invalid proxy server was used.
	Specify the port of the proxy server using a number in the range of 1 to 65535.	The port number of an invalid proxy server was used.

List of Messages

	Messages	Cause
Configuration	Specify the maximum retention period.	The value of the maximum retention period was not entered.
	Specify one or more days for the maximum retention period.	An attempt was made to configure the maximum retention period using a value of less than 1 day.
	Specify the maximum file size/duration.	The value of the maximum file size/duration was not entered.
	Specify 1024MB or less for the maximum file size.	An attempt was made to configure the maximum file size using a value larger than 1024MB.
	Specify 32MB or more for the maximum file size.	An attempt was made to configure the maximum file size using a value less than 32MB.
	Specify 24 hours or less for the maximum file duration.	An attempt was made to configure the maximum file duration using a value larger than 24 hours.
	Specify 1 hour or longer for the maximum file duration.	An attempt was made to configure the maximum file size using a value less than 1 hour.
	Specify the maximum disk space used.	The value of the maximum disk space used was not entered.
	Specify 32MB or more for the maximum disk space used.	An attempt was made to configure the maximum disk space used using a value less than 32MB.
Specify the notification settings for the low disk space warning level.	The value of the low disk space warning level was not entered.	
When exiting the application or approving the change in all tabs	An error occurred in the configuration file	An error occurred while saving the Storage Server settings.
	An error occurred while writing the user file	An error occurred while saving the user management information (the users.txt file).
	When you change the retention period, the recorded video may be deleted. Are you sure you want to continue?	The maximum retention period was changed to a shorter period.

	Messages	Cause
When exiting the application or approving the change in all tabs	Are you sure you want to save the changes?	An attempt was made to exit the application without saving the setting change.
All tabs	Initialization of network communication failed.	Communication initialization was interfered with due to an internal program or OS error that occurred when the Storage Server installation was activated.

Confirmation Messages of Viewer

The ' ' part of the message differs depending on the situation.

	Messages	Cause
Registering Storage Servers and Camera Servers	Are you sure you want to delete this camera server 'camera server name'?	An attempt was made to delete the camera server.
Another Add Camera Server dialog	All schedules configured for the 'camera number' will be deleted. Select "Yes" to continue, or select "No" to cancel.	When you attempted to edit the VB150 settings, it was detected that the camera configuration has been changed on the VB150 side and the camera for which the schedule was configured no longer exists.
Saving/Managing Video Layouts	A layout with the same name is already registered. Are you sure you want to overwrite?	An attempt was made to save the current layout using the same name as a layout that already exists.
	Are you sure you want to delete the following layout? 'Layout name'	An attempt was made to delete the layout.
	Are you sure you want to delete the following folder with the layouts in the folder? 'Folder name'	An attempt was made to delete the layout folder.

Error Messages of Viewer

The ‘ ’ part of the message differs depending on the situation.

	Messages	Cause
Starting the Viewer	Connection to the Master Storage Server failed. Check the settings and try again.	An attempt was made to start the Viewer, however a connection to the specified Master Storage Server could not be established.
Configuration and Preferences screen	The configuration window can only be used by administrators.	An attempt was made by a user without the administrator privilege to switch to the Configuration window.
	The recording settings of the camera server cannot be configured for this Storage Server ‘Storage Server name’. ‘Cause of the error’	A connection to a Storage Server other than the Master Storage Server failed when you accessed the Configuration and Preferences screen.
	The changes cannot be saved because it cannot be sent to ‘Storage Server name’.	An attempt was made to save the changes in the Camera Server list in the Configuration and Preferences screen, however a connection to the Storage Server could not be established.
	The changes to the thumbnail, location and zone were not saved because the Master Storage Server settings have been changed by another administrator. Restart the Viewer.	An attempt was made to save the changes in the Camera Server list, however another administrator has conducted changes.
	The Master Storage Server settings have been changed by another administrator. Restart the Viewer.	Another administrator changed the Master Storage Server settings while the Camera Server list was displayed.
Adding/Editing/Deleting the Storage Server	This host name or IP address cannot be specified.	An attempt was made to register a Storage Server by specifying a loop back host/address (“local host”, “127.0.0.1” or “localhostlocaldomain”).
	This Storage Server is already registered. Check the settings and try again.	An attempt was made to add a Storage Server that has been already registered.
	The Master Storage Server cannot be changed here.	An attempt was made to edit the Master Storage Server.

	Messages	Cause
Adding/Editing/ Deleting the Storage Server	The camera server settings have not been saved. Save or delete the settings before changing the Storage Server settings.	An attempt was made to change/delete the Storage Server while there are camera server settings that have not been saved.
	The Master Storage Server cannot be deleted.	An attempt was made to delete the Master Storage Server.
	The host name of the Storage Server is invalid. Check the host name or IP address.	The host name or IP address was invalid when OK was pressed.
	The port number of the Storage Server is invalid. Specify a number in the range of 1 to 65535.	The port number was invalid when OK was pressed.
	Specify the host name of the Storage Server.	An attempt was made to add or edit a zone in the Storage Server without entering the name.
Adding/Editing a Location and Zone	This location name cannot be used because it already exists.	An attempt was made to register a location name that is already registered.
	The location name is not specified.	An attempt was made to register a location without entering the name.
	Delete the added zone before deleting the location.	An attempt was made to delete the location for which a zone has been added.
	Select a location.	An attempt was made to add a zone while the location has not been registered.
	This zone name cannot be used because it already exists.	An attempt was made to add a zone with a name that has been already registered.
	The zone name is not specified.	An attempt was made to register a zone without entering the name.
	Delete the added camera server before deleting the zone.	An attempt was made to delete the zone for which a camera server has been added.

List of Messages

	Messages	Cause
Adding a Camera Server	The recording settings of this camera server have already been configured in the selected Storage Server. Check the settings and try again.	Even though video of a camera server is configured to be recorded in the Storage Server, the IP address and port used are the same as the camera server that has been configured in the Storage Server.
	Select a location and zone.	An attempt was made to add a camera server without selecting a location and zone.
	Select a location and zone. 'Camera number'	An attempt was made to add a camera server without selecting a location and zone. This is displayed when VB150 is in the "simultaneous" mode and multiple cameras are connected.
	The camera server with the same host name and port number is being deleted. Save the changes and add the server again.	After deleting the camera server, an attempt was made to add the camera server again when the changes have not been saved.
	The host name specified in "Connection Settings" is invalid. Check the host name or IP address.	An attempt was made to connect with an invalid host name/IP address.
	The port number specified in "Connection Settings" is invalid. Specify a number within the range of 1 and 65535.	An attempt was made to connect with an invalid port number.
	The host name specified in "Storage Server Configuration" is invalid. Check the host name or IP address.	An attempt was made to connect to the Storage Server with an invalid host name/IP address.
	The port number specified in "Storage Server Configuration" is invalid. Specify a number within the range of 1 and 65535.	An attempt was made to connect to the Storage Server with an invalid port number.
Recording Schedule	An error occurred relating to the schedule change of 'schedule name' for the camera 'camera name' registered in the Storage Server 'Storage Server name'. This change will not be reflected on the Storage Server side.	The destination Storage Server was not found when you attempted to save the schedule.

	Messages	Cause
Recording Schedule	An error occurred relating to the schedule deletion of 'schedule name' for the camera 'camera name' registered in the Storage Server 'Storage Server name'. This change will not be reflected on the Storage Server side.	The destination Storage Server was not found when you attempted to delete the schedule.
	An error occurred when you obtained the schedule setting information of the Storage Server 'Storage Server name'. This change will not be reflected on the Storage Server side.	The Storage Server in which the schedule is to be saved was not found when you attempted to display the Recording Schedules window or to switch the Storage Server.
	This schedule overlaps with other schedule. Check the settings and try again.	The recording schedules are overlapping.
	For the end time of a schedule, a time of at least 15 minutes later than the start time must be specified. Check the settings and try again.	An attempt was made to register a schedule with a shorter period than 15 minutes.
	Do you want to save the change in the recording schedule?	An attempt was made to close the Normal or Special Day Schedule screen without saving the change.
	The schedule for the following camera is not created because the specified time frame has already been configured for another schedule.	The Recording Schedules window was dragged in order to add multiple recording schedules, however the camera server for which a schedule has already been configured exists.
	The multiple schedules could not be added. All of the schedules attempted to create overlap with other schedules.	A layout or layout sequence with the same name exists in the folder to which the layout or layout sequence is moved or copied.
Special Day Schedule	This special day schedule is added with a date that uses a schedule. Delete the date before deleting the special day schedule.	An attempt was made to delete the special day schedule that is planned to execute.

List of Messages

	Messages	Cause
Special Day Schedule	This date is already used. In order to use it in another special day schedule, the date must be deleted from the original special day schedule 'special day schedule name'.	An attempt was made to use the data for which another special day schedule is already configured.
	The end time of the special day schedule cannot be set on the next day. Check the settings and try again.	An attempt was made to register a schedule that passes 24:00.
	This special day schedule name cannot be used because it already exists.	An attempt was made to add a special day schedule with a name that is already registered.
Viewing Screen	Communication with the Storage Server 'Storage Server name' failed. Press OK to reconnect to the Storage Server. When Cancel is pressed, the video information and event information of the camera servers registered in this Storage Server can no longer be referred. Restart the Viewer manually.	When displaying the Viewing Screen, the Viewer connects to a Storage Server. An error occurred during this process. When multiple Storage Servers are registered, the Viewing Screen may be displayed for each of the servers.
	The following layout has been deleted from the layout sequence.: 'Layout name' Press OK to continue the layout sequence.	There is a layout that can only be seen while the layout sequence is being executed, and the user has the right to edit the layout sequence.
	The following layout cannot be found. Contact your administrator when deleting the layout from the layout sequence. 'Layout name' Press OK to continue the layout sequence.	The shared layout sequence was started, however there is a layout that cannot be seen and the user does not have the administrator privilege.
	The layouts registered in this layout sequence cannot be found.	The shared layout sequence was started, however there are no layouts that can be seen and the user does not have the administrator privilege.
	The layout registered in this layout sequence cannot be found. Press OK to edit this layout sequence, or press Cancel to return to the previous layout.	The layout sequence was started, however there are no layouts that can be seen. The right to edit the layout sequence is possessed.

	Messages	Cause
Viewing Screen	The configuration window can only be used by administrators.	An attempt was made by a user other than an administrator to switch to the Configuration window.
	Do you want to save the change in this layout?	An attempt was made to close a layout that has been changed.
	The image could not be saved.	A still image was captured using snapshot but it could not be saved.
	Nothing could be saved because no video was recorded at the specified time.	There are no recorded videos for the selected segment thus they could not be saved.
	Manual recording of the camera 'camera name' registered in the Storage Server 'Storage Server name' could not be started. *The following message is added when the number of camera servers exceeds the licensing restrictions. The number of camera servers exceeds the number allowed in the licensing agreement.	Manual recording could not be started.
	The layout sequence settings will be overwritten. Are you sure you want to continue?	An attempt was made to save the layout sequence with a name that is already being used for a layout or layout sequence in the destination folder.
	A layout with the same name is already registered. Are you sure you want to overwrite?	An attempt was made to save the layout sequence in the folder using a name that is already been registered as a layout or layout sequence.
Saving/Managing Video Layouts	'Layout name' cannot be deleted because it is currently in use.	An attempt was made to delete a layout that is currently being used.
	The name is not specified. Check the settings and try again.	An attempt was made to add a layout folder without entering the name.
Menu Buttons	The image could not be saved.	An error occurred when you attempted to capture a snapshot in the Video Window.

List of Messages

	Messages	Cause
Extracting Video	Nothing could be saved because no video was recorded at the specified time.	There are no recorded videos for the selected segment thus they could not be saved.
Adding/Editing a Camera Server	The recording settings of this camera server are not configured but the server has already been registered. Check the settings and try again.	When a camera server configured as Do not record is already added, an attempt was made to add or edit a camera server using the same hot name/IP address and port number.
	Could not connect to the camera server. Check the entered information. 'Communication Error Messages - Details'	Could not connect to the camera server.
Add/Edit Camera Server dialog, Add/Edit Recording Schedule dialog, Motion Detection Settings dialog, Sensor Event Settings dialog	The connection to the camera server has been disconnected.	An error relating to the camera server connection occurred.
	An error relating to the camera server connection occurred.	An unknown error relating to the camera server connection occurred.
Add/Edit Recording Schedule dialog	Specify the day.	OK was pressed without specifying the day.
	Specify the recording mode.	OK was pressed without selecting the recording mode check box.
	Specify the recording frame rate between 'fps' and 'fps'.	An invalid recording frame rate was entered.
Add/Edit Recording Schedule dialog, Motion Detection Settings dialog	The maximum value of the pre-event recording is 30 seconds.	OK was pressed after configuring a value exceeding 30 seconds for the pre-event time value.
Camera Summary window	The change cannot be saved because it cannot be sent to the Storage Server 'Storage Server name'. 'Communication Error Messages - Details'	An error occurred while saving the settings in the Camera Summary window.

	Messages	Cause
Camera Summary window	Are you sure you want to delete the Storage Server 'Storage Server name'?	An attempt was made to delete a Storage Server other than the Master Storage Server.
	Are you sure you want to delete the location 'location name'?	An attempt was made to delete the location.
	Are you sure you want to delete the zone 'zone name'?	An attempt was made to delete the zone.
	Are you sure you want to delete this camera server 'camera server name'?	An attempt was made to delete the camera server.
	Do you want to save the changes in the server registration?	An attempt was made to close the Camera Summary window without saving the changes.
	An error occurred while saving the settings in the Master Storage Server.	An attempt was made to save the settings, however, saving the Master Storage Server settings failed.
Connect to Master Storage Server dialog, Connection Error dialog	The host name of the Master Storage Server is invalid. Check the host name or IP address.	An attempt was made to connect with an invalid host name/IP address.
	The port number of the Master Storage Server is invalid. Specify a number in the range of 1 and 65535.	An attempt was made to connect with an invalid port number.
Edit Camera Server dialog	All schedules configured for the 'camera server name' will be deleted. Select "Yes" to continue, or select "No" to cancel.	OK was pressed in the Edit Camera Server dialog when a change was made to the camera registered in the camera server.
Event Search dialog	There are no events.	No events to be displayed in Event Search were found.
Extract Video dialog	Specify the start time and end time so that the time interval is 1 hour or shorter.	An attempt was made to configure the time using a value longer than 1 hour.
	The recorded video data cannot be read.	The recorded video at the specified time cannot be read.
Folder Name dialog	The name is not specified. Check the settings and try again.	An attempt was made to add a layout folder without entering the name.

List of Messages

	Messages	Cause
Layout Sequence dialog	A user layout cannot be specified in shared layout sequences. Delete the following layout before saving the shared layout sequence.	An attempt was made to change the layout sequence that contains a personal layout sequence to a shared layout sequence.
Motion Detection Settings dialog	Specify the frame rate for the motion detection settings between 'fps' and 'fps'.	An invalid value was selected for the motion detection frame rate.
	Specify the recording frame rate between 'fps' and 'fps'.	An invalid value was selected for the motion detection recording frame rate.
Normal or Special Day Schedule window and Add/Edit Camera Server dialog	The recording settings of the camera server cannot be configured for this Storage Server 'Storage Server name'. 'Communication Error Messages - Details'	An error occurred while connecting to the Storage Server, when the Normal or Special Day Schedule window is opened or the Storage Server in the Recording Schedules window is changed. Or, a communication error occurred when you were adding/editing a Storage Server.
Organize Layouts & Layout Sequences dialog	The layout that is currently being used will be overwritten. Are you sure you want to continue?	There is a layout with the same name in the destination to which the layout is moved and the name is the same as the layout that is being currently used.
	'Layout name' cannot be deleted because it is currently in use.	An attempt was made to delete the current layout or the folder that contains the current layout or layout sequence.
	Are you sure you want to delete the following layout? 'layout name'	An attempt was made to delete a layout that is not currently being used.
	Are you sure you want to delete the following folder with the layouts in the folder? 'layout name'	An attempt was made to delete the layout folder.
	Are you sure you want to delete the layout sequence?	An attempt was made to delete the layout sequence.
	It cannot be deleted because it is used in the running layout sequence.	An attempt was made to delete a layout that is registered in the current layout sequence.

	Messages	Cause
Organize Layouts & Layout Sequences dialog	It cannot be overwritten because it is used in the layout sequence.	An attempt was made to change or overwrite the layout that is being used in the currently active layout sequence.
	The folder cannot be created. 'Folder name' already exists.	An attempt was made to create a new folder with a name that is already being used.
	The layout name cannot be changed. 'Layout name' already exists.	An attempt was made to change the name of a layout or layout sequence to a name that is already being used.
	The folder name of the layout cannot be changed. 'Folder name' already exists.	An attempt was made to change the name of a folder to a name that is already being used.
	A layout with the same name is already registered. Are you sure you want to overwrite?	A layout or layout sequence with the same name exists in the folder to which the layout or layout sequence is moved or copied.
	A layout or folder with the same name is already registered.	A folder with the same name as the folder to which the layout or layout sequence is moved or copied exists. Or, a layout or layout sequence with the same name exists in the folder to which the folder is moved or copied.
	It cannot be deleted because it is used in the layout sequence.	An attempt was made to delete the current layout sequence.
Sensor Event Settings dialog	Specify the frame rate for the sensor 'sensor name' recording between 'fps' and 'fps'.	An invalid recording frame rate was entered.
Sensor Settings dialog	The maximum value of the pre-event sensor 'sensor name' recording is 30 seconds.	OK was pressed after configuring a value exceeding 30 seconds for the pre-event time value.
Viewer Settings window	Do you want to save the changes in the Viewer settings?	An attempt was made to close the Viewing Screen without saving the changes.

VK-64/VK-16 Recording Engine Logs

A list of messages shown in the Storage Server log file “nvr_re_log_<N>.txt” (<N> is either 0 or 1) is shown below. These messages are generated by the recording engine (Win32 service) that runs as part of a Storage Server.

Messages	Cause	Action
Camera <camera>: <x>/<y> frames discarded due to busy drive thread in last 1 minutes.	x frames out of y frames are discarded because there were a large number of frames that have been requested to be written in the disk. It is difficult for the current settings of the recording engine to process this amount of tasks. This message is recorded when recording failure occurs when disk is under a heavy load.	Reduce the system load using the following methods. 1) Reduce the amount of data to record (For example, lower the resolution or frame rate). 2) Install an additional hard disk. 3) Implement an action such as upgrading the CPU, or increasing memory or existing hard disk space.
Camera <camera>: <x>/<y> frames discarded due to busy frame queue in last 1 minutes.	x frames out of y frames are discarded because there were a large number of unprocessed frames. It may be that CPU or hard disk drive is unable to process data at the same speed rate as the data reception. This message is recorded when recording failure occurs due to motion detection or too many event occurrences.	Reduce the system load using the following methods. 1) Reduce the amount of data to record (For example, lower the resolution or frame rate). 2) Install an additional hard disk. 3) Implement an action such as upgrading the CPU, or increasing memory or existing hard disk space.
Error resolving name for POP server host: port Error: <Winsock error code>: <Error message>	When sending E-mail, the recording engine could not resolve the host name of the POP server.	Refer to the corresponding Winsock error code in “A List of Error Codes in Log File” (→ P. 263).
Error connecting socket for POP server host: port Error: <Winsock error code>: <Error message>	When sending E-mail, the recording engine could not connect to the POP server.	Refer to the corresponding Winsock error code in “A List of Error Codes in Log File” (→ P. 263).
POP connection error: 0 POP response: <pop response>	When sending E-mail, an error occurred in the first response sent after connecting to the POP server.	Refer to “A List of Error Codes in Log File” (→ P. 263).
POP user error: 0 POP response: <pop response>	When sending E-mail, the user name entered for the POP server could not be authenticated.	Check the Storage Server configuration to see if the entered user name is correct.

Messages	Cause	Action
POP password error: 0 POP response: <pop response>	When sending E-mail, the password entered for the POP server could not be verified.	Check the Storage Server configuration to see if the entered password is correct.
Error resolving name for SMTP server host: port Error: <Winsock error code>: <Error message>	When sending E-mail, the recording engine could not resolve the host name of the SMTP server.	Refer to the corresponding Winsock error code in "A List of Error Codes in Log File" (→ P. 263).
Error connecting SMTP to server host: port Error: <Winsock error code>: <Error message>	When sending E-mail, the recording engine could not connect to the SMTP server.	Refer to the corresponding Winsock error code in "A List of Error Codes in Log File" (→ P. 263).
Error sending E-mail. SMTP server log follows: <SMTP error message>	The recording engine could not send E-mail due to a communication error with the SMTP server. Please refer to the SMTP server log for details.	Refer to the corresponding SMTP error code in "A List of Error Codes in Log File" (→ P. 263).
NVR recording engine stopping	This is always displayed when the recording engine stops.	There is no necessary action.
NVR Recording Engine startup complete. Log level = (<log level>)	This is always displayed when the recording engine starts. The value in "Log Level" indicates the log level that is currently being configured (The default is 1).	There is no necessary action.
Unable to register a drive for camera <host>:<port>.	The storage destination drive configured for this camera server has been deleted.	Change the storage destination drive of the camera server in Configuration of the Viewer. When the drive of the camera server remains unchanged even after this message is displayed, the Viewer may become unable to connect to the Storage Server. When this occurs, stop the Storage Server and open the following file using notepad or other application to delete the drive configuration in which the problem is occurring.

List of Messages

Messages	Cause	Action
Error deleting old file <windows error message>.	A system error occurred when deleting the file. This file is probably being used by the access engine or other application. When this file is being used for playing a recorded video, this error is normal.	There is no necessary action.
Error writing frame for camera <camera>: <error message>	Cannot write data in the hard disk.	Check to ensure that the specified drive is not configured as read-only. In addition, ensure that all directories in this path are writable. When the drive cannot be used due to the above reason, configure it in a way so that there are no camera servers records on this drive. * This is also recorded when the date & time of the PC is reset to past. When this occurs, this error will no longer be recorded when the date and time is reset to the current date and time.
ERROR(timeout): socket type=(IMAGE/EVENT/COMMAND), cameraserver=(<host>:<port>)	A timeout occurred while waiting for a response from the specified camera server. This normally occurs when the camera server is offline. IMAGE == Get image process EVENT == Get camera server status process implemented by GetNotice COMMAND == Camera server operation/configuration change command process	Check to ensure that the camera server is on and connected to the network. If a proxy server is configured using the Storage Server Configuration tool, check to ensure that the proxy server is running.
ERROR(connect): socket type=(IMAGE/EVENT/COMMAND), cameraserver=(<host>:<port>) win32_error=(<Winsock Winsock error code>:<error message>)	An error occurred when connecting to the specified camera server. IMAGE == Get image process EVENT == Get camera server status process implemented by GetNotice COMMAND == Camera server operation/configuration change command process * same applies for "ERROR (WSAConnect)".	Refer to the corresponding Winsock error code in "A List of Error Codes in Log File" (→ P. 263).

Messages	Cause	Action
ERROR(http): socket type=(IMAGE/EVENT/COMMAND), cameraserver=(<host>:<port>) http_status=(<HTTP error code>)	An HTTP error occurred when connecting to the camera server. IMAGE == Get image process EVENT == Get camera server status process implemented by GetNotice COMMAND == Camera server operation/configuration change command process	Refer to the corresponding HTTP error code in "A List of Error Codes in Log File" (→ P. 263).
Failed to write camera configuration file	Cannot overwrite the camera server configuration file. The setting changes conducted after the recording engine started cannot be saved.	Check to ensure that you have the write privilege for the LocalSystem account in the VK-64/VK-16 configuration directory.
ERROR: Out of memory -- please check configuration of this PC	Failed to reserve memory in the recording engine since the system memory is under a heavy load because unprocessed frames continued to increase. An application error will occur in a few seconds and the Storage Server functions will stop.	Reduce the system load using the following methods. 1) Reduce the amount of data to record (For example, lower the resolution or frame rate). 2) Install an additional hard disk. 3) Implement an action such as upgrading the CPU, or increasing memory or existing hard disk space.
Camera <camera> Effective recording rate (y%->z%)	The recording frame rate has been changed from y% to z% because the load of the recording engine continued to increase (decrease).	Even though there is no necessary action, you can reduce the system load using the following methods if you want to avoid frame rate decrease events. 1) Reduce the amount of data to record (For example, lower the resolution or frame rate). 2) Install an additional hard disk. 3) Implement an action such as upgrading the CPU, or increasing memory or existing hard disk space.
ERROR(http): socket type=(Image), cameraserver=(<host>:<port>) http_status=400	An HTTP 400 error occurred when getting the image.	It may be connected to SNC-P5, DF40N in the MPEG mode. Change it to the JPEG mode. For other causes, refer to the corresponding HTTP error code in "A List of Error Codes in Log File" (→ P. 263).

Access Engine Log

A list of messages shown in the Storage Server log file “nvr_ae_log_<N>.txt” (<N> is either 0 or 1) is shown below. These messages are generated by the access engine (Win32 service) that runs as part of a Storage Server.

Messages	Cause	Action
NVR Access Engine startup complete. Log level = <log level>	It indicates that startup of the access engine has been completed.	There is no necessary action.
NVR Access Engine has finished shutting down.	The access engine has been stopped.	There is no necessary action.

VK-64/VK-16 Viewer Logs

A list of messages shown in the VK Viewer log file “nvr_viewer_log_<N>.txt” (<N> is either 0 or 1) is shown below.

Messages	Cause	Action
CHttpVbSetngThread: inet error=<wininet error code>, winsock error=<Winsock error code>, count=<Number of occurrences>	A network error occurred while communicating with the camera server (This is recorded when a problem occurs in configuration protocol communications).	Refer to the corresponding Winsock error code in “A List of Error Codes in Log File” (→ P. 263).
vbc_HttpCommand:inet error=<wininet error code>, winsock error=<Winsock error code>, count=<Number of occurrences>	A network error occurred while communicating with the camera server (This is recorded when a problem occurs in WV-HTTP protocol communications).	Refer to the corresponding Winsock error code in “A List of Error Codes in Log File” (→ P. 263).

Log Storage Destination

- The Storage Server logs are stored in the following folder in the PC where the Storage Server is installed.
<System drive>:\Documents and Settings\All Users\Application Data\Canon\WebView\NVR\logs\
- The Apache logs used by the Storage Server are stored in the following Storage Server installed folder.
<Storage server installed folder>: \websrvr\logs\
- The Viewer logs are stored in the following folder in the PC where the Viewer is installed.
<System drive>:\Documents and Settings\All Users\Application Data\Canon\WebView\NVR\logs\

A List of Error Codes in Log File

● A List of Winsock Error Codes

Codes	Error Messages	Description
10038	An operation was attempted on something that is not a socket.	This may be recorded in Version 1.1, however, there is no necessary action.
10048	Only one usage of each socket address (protocol/network address/port) is normally permitted.	All resources for communication are being used. This frequently occurs when a black screen problem occurs in Viewer layout sequences.
10050	A socket operation encountered a dead network.	This occurs when the PC recognizes that the network is not available because the closest router or Hub to the PC is powered off. Normally, this cannot be recognized, therefore it is rare that this error is reported.
10051	A socket operation was attempted to an unreachable network.	This occurs when another network device recognizes that the network is not available because the router or Hub is powered off. Normally, this cannot be recognized, therefore it is rare that this error is reported.

List of Messages

Codes	Error Messages	Description
10054	An existing connection was forcibly closed by the remote host.	The connection is disconnected by the camera server due to camera server restart or other cause. This may occur when the camera server is restarted using the restart button on the configuration page on the software-side. However, this rarely occurs.
10060	A connection attempt failed because the connected party did not properly respond after a period of time, or established connection failed because connected host has failed to respond.	A timeout occurred in the TCP connection with the camera server (This occurs when the camera server is down).
10061	No connection could be made because the target machine actively refused it.	The camera server rejected the TCP connection (This occurs when the port number specification is incorrect or other cause).
10064	A socket operation failed because the destination host was down.	This is recorded when the camera server is down (Normally, 10060 occurs).
10065	A socket operation was attempted to an unreachable host.	There are no routes to connect to the camera server (This may also occur when there is a failure in the network cable connected to the PC or HUB).
10091	WSAStartup cannot function at this time because the underlying system it uses to provide network services is currently unavailable.	There is a failure on the PC network board.
11001	No such host is known.	The host name in DNS could not be resolved.
11004	The requested name is valid, but no data of the requested type was found.	The host name in DNS could not be resolved (11004 may occur instead of 11001 in 2003).

 A List of SMTP Error Codes

Codes	Error Messages	Description
421	<domain> Service not available, closing transmission channel	The communication is terminated because the mail server stopped.
450	Requested mail action not taken: mailbox unavailable	The requested mail process was not executed because the mailbox is not available.
451	Requested action aborted: local error in processing	The requested execution was canceled because an error occurred in the mail server.
502	Command not implemented	The mail server does not support the command that was sent.
550	Requested action not taken: mailbox unavailable	The request was not executed because the mailbox is not available.

 **A List of HTTP Error Codes**

Codes	Error Messages	Description
400	Bad Request	When more than 4 Storage Servers are connected when a Sony camera is used. This is recorded when the operation mode of the camera server is mpeg4.
401	Unauthorized	The user authentication or password for connecting to the camera server is incorrect.
403	Forbidden	This is recorded when the connection cannot be established due to the IP address restriction on the camera server side (It may also be returned by the proxy server).
500	Internal Server Error	This occurs when the webview server is not running even when the HTTP server is running. This may also be recorded even during normal operation if the camera server is restarted.
502	Bad Gateway	This is recorded when the proxy server returned an HTTP 502 error (which occurs when the proxy server receives an error from the upper proxy).
503	Service Unavailable	This is recorded when the proxy server returned an HTTP 503 error (which occurs when the proxy server failed to connect to the camera server).
504	Gateway Time-out	This is recorded when the proxy server returned an HTTP 504 error (which occurs when the proxy server could not receive a reply from the upper proxy).

A List of wininet Error Codes

Codes	Error Messages	Description
12002	The request has timed out.	A request timeout occurred. It indicates that connection or request transmission failed.
12005	The URL is invalid.	The URL is incorrect (Normally, this does not occur, however, it may occur when an attempt is made to connect to an unsupported camera server).
12007	The server name could not be resolved.	The host name could not be resolved (This error indicates when a host name that is not registered in DNS is specified or that a problem occurred in communication with DNS).
12017	The operation was canceled, usually because the handle on which the request was operating was closed before the operation completed.	The communication was canceled (This error is not a problem, it may be recording during normal operation).
12029	The attempt to connect to the server failed.	The connection to the camera server failed (Normally 12002 is recorded).
12030	The connection with the server has been terminated.	The connection to the camera server has been disconnected (The disconnect process itself is recorded when it is executed normally).
12031	The connection with the server has been reset.	The connection to the camera server has been disconnected forcibly.

A List of POP Error Codes

Error Messages	Description
ERR never heard of mailbox name	The mail address is incorrect.
ERR invalid password	The password is incorrect.
ERR unable to lock maildrop	The mailbox cannot be used (Another program is already using it).

VK Event Information

Event type	Displayed Messages
Starting or stopping the recording engine	Start (on)/Stop (off) Recording engine {status}
User logon	on User {user name} logon
Sensor	on/off The sensor {sensor name} is {status}.
Motion detection	on/off The motion detection is {status}.
Starting or stopping recording	Start (on)/Stop (off) Stop recording or Start recording. Pre-event Recording (configured duration) (sec.)
Starting or stopping the recording settings	Create (on)/Close (off) Recording setting {number} {status}
Manual recording and custom trigger	Start (on)/Stop (off) For manual recording: The user {user name} set the manual recording to {status}. For custom recording: (Custom text provided by the triggered client).
Disk space warning	Warning (on)/recovered (off) {Drive} Low disk space: {status}
Starting or stopping deleting due to low disk space	Start (on)/Stop (off) Low disk space {drive} Delete files in the drive: {status}
Starting or stopping recording due to low disk space	Start (on)/Stop (off) Low disk space {drive} Hold recording to the drive: {status}
Connection error to the camera server	Error (on)/recovered (off) Connect to the host ({camera server address}:{port}): {status}
Continuing recording	Continuing recording

Event type	Displayed Messages
Changing the recording frame rate	Valid recording rate ({recording rate before change} → {recording rate after change} %) “Recording rate” is the ratio of received images that are actually being recorded. If the rate is 100%, then all received images are recorded. If 50%, 1 frame per 2 frames is recorded.

Error Number: Error Description	Cause
10048: The socket cannot be used.	A socket for the communication could not be generated because a large number of TCP connections are used in the PC.
10050: The network is down.	The network is down (when a failure occurs in a HUB or router located near the PC).
10051: The network cannot be reached.	A failure occurred in a HUB or router near the camera server.
10054: Forcibly disconnected by the camera server.	The TCP connection is disconnected because the camera server was restarted or another cause.
10060: Connection timeout	A timeout occurred in the TCP connection with the camera server (This occurs when the camera server is down).
10061: The connection to the camera server was rejected.	The camera server rejected the TCP connection (This occurs when the port number specification is incorrect or another cause).
10064: The camera server is down.	The camera server is down (Normally, 10060 occurs).
10065: The camera server cannot be reached.	There are no routes to connect to the camera server (This may also occur when there is a failure in the network cable connected to the PC or HUB).
10091: Failure on the network board	There is a failure on the PC network board.
11001: The host name is unknown.	The host name in DNS could not be resolved.
11004: The host name is unknown.	The host name in DNS could not be resolved (11004 may occur instead of 11001 in 2003).
Empty character string	Other Winsock Errors

List of Messages

Error Number: Error Description	Cause
HT401: Account restriction	The user authentication or password for connecting to the camera server is incorrect. Check to ensure that it is not an on/off event.
HT403: IP address restriction	Cannot connect due to the IP address restriction on the camera server side.
HT502: Bad Gateway 502	The proxy server returns an HTTP 502 error (which occurs when the proxy server receives an error from the upper proxy).
HT503: Service unavailable 503	The proxy server returned an HTTP 503 error (which occurs when the proxy server failed to connect to the camera server).
HT504: Gateway Timeout 504	The proxy server returned an HTTP 504 error (which occurs when the proxy server could not receive a reply from the upper proxy).

Appendix

Control of the Camera Server

The following figure shows the order of priority for Camera Server control.

	Application	
Strong ↑	Panorama Creation Tool	
	WebView Admin Viewer/NC Viewer (Administrator)	
	Motion Detection Settings Tool (VB-C50i Series VB Administration Tool)	
	VK-64/VK-16 Storage Server (when a preset is specified for sensor recording)	
	Motion Detection Module (VB-C50 Series)	
	Operating the Camera Server in the VK-64/VK-16 settings window	
	VK-64/VK-16 Viewer (when the Camera Server is operated in the Viewer)	
	VK-64/VK-16 Storage Server (when a recording position is specified) VK Preset Tour	
	NC Viewer (Authorized User), Viewer for PC/Viewer for Java (VB-C50i Series)	
	Weak	VB-C50 Preset Tour

When a recording position is specified in VK-64/VK-16, you cannot operate the Camera Server in the Viewer for PC/Viewer for Java/NC Viewer.

About Hard Disk

Lifetime of Hard Disk

A hard disk is a storage device that works physically, and has a limited lifetime. It is a kind of consumables. It is said that the average lifetime of a RAID system composed of SCSI hard disks is three years. However, this lifetime is considered to be true for standard file servers or business servers. The disk failure rate of VK-64/VK-16 systems is higher than that of general file servers. It is reasonable to assume that the lifetime of hard disks in a VK-64/VK-16 system is about half of that of a standard file server (one and a half years).

Therefore, when you build a VK-64/VK-16 system, it is advisable to provide a hot-spare (spare hard disks that are active) for RAID configuration.

RAID Reconfiguration

If one of hard disks in RAID1 and RAID5 systems breaks down, you can restore the system by replacing the broken hard disk before other disks break.

Restoring the data stored on the broken hard disk after replacement is referred to as rebuilding.

During RAID rebuilding, a recording error may occur because disk system performance deteriorates.

● RAID Rebuilding Time

When a failure occurs in a hard disk in a RAID system and you want to replace it with a hot-spare or new one, the rebuilding time is to be considered as follows:

- Rebuilding takes about one minute per 1GB when no I/O is performed in a SCSI RAID card.
- When a RAID system is composed of four SCSI hard disks of 300GB each, the total disk size of the hard disks is 1200GB. To rebuild this system, 1200 minutes (20 hours) are required on the condition that there no I/O is performed.
- If rebuilding takes 20 hours when there is no I/O, the rebuilding time for a VK-64/VK-16 system where I/O is continuously performed can be assumed to be about twice 20 hours. Thus, when you perform rebuilding without stopping recording, it takes about 40 hours.
- There is no problem if rebuilding only takes a long time. However, the other hard disks may break down one after another during such rebuilding. If another hard disk breaks down during rebuilding, all of the stored data will be lost. Therefore, it is preferable to reduce rebuilding time as far as possible.

● **Configuration for Reducing Rebuilding Time**

As described in the preceding section, it is important to shorten rebuilding time as far as possible. You can reduce rebuilding time by configuring hard disks as follows:

For example, when you create two configurations including three 146GB hard disks and a hot-spare, instead of creating one configuration (900GB) including three 300GB hard disks and a hot-spare, rebuilding requires less time and risks are reduced.

● **Measures to be Taken When Rebuilding**

To reduce the load on the PC during rebuilding and to shorten the rebuilding time, it is also advisable to implement the following measures:

- Stop the Storage Server program before rebuilding.
- Temporarily reduce the recording frame rate during rebuilding.

● **Notes on Consistency Check of RAID Configuration Information**

For stable operation of hard disks, you need to regularly perform consistency check of RAID configuration information. This is especially effective for preventing data inconsistency when rebuilding is performed. However, as with rebuilding, the consistency check of RAID configuration information imposes a burden on the PC for a long period of time.

In a consistency check of RAID configuration information, measures such as configuring hard disks in the same way as in rebuilding and reducing the load on the PC, are also important. Refer to “Measures to be Taken When Rebuilding”.

Backup of VB Settings

Overview

To backup or restore the setting values of the network camera, use “VB-C50i Series Setting Values Backup/Restore Tool” (hereafter referred to as “Tool”). Specify one network camera, and backup or restore the setting values through interactive operations.

Operating Environment

The operating environment of the Tool is as follows:

OS:

- Windows 2000 Professional (with SP4)
- Windows XP Home Edition/Professional (with SP1a, SP2)
- Windows Server 2003 (with SP1)

Web Browser:

- Internet Explorer 6.0
(Build Number 6.0.2800.1106 and later)

Hardware:

- PC recommended for the above OS

Target Camera Server:

- VB-C50i, VB-C50iR, VB-C50Fi, VB-C50FSi

Installation

Download the necessary files from the following Web site:

URL: canon.com/webview

Double-click “VBC50BK.exe” or “VB50RS.exe” stored on your hard disk and then start it.

Notes

<Backup Tool/Restore Tool>

- Before using the Tool, close any other applications.
- Use the Tool in a secure network environment such as an intranet.
- Transmit or receive files via FTP (HTTP proxy is not supported).

<Restore Tool>

- You can restore backup files only when their model, the video signal (NTSC/PAL), and whether they have audio input or not, correspond to the network camera to which you want to restore the files.
- You cannot restore backup files created by a new version of firmware to a network camera of which the firmware is of an older version.
- For backup files, specify the files created by Setting Values Backup Tool.
- You cannot restore backup files that have been edited or converted.
- Do not change the administrator password and network settings (address setting method, IP address, subnet mask, default gateway) from the values specified in the network camera.

Index

A

Add Camera Server.....	87
Add Camera Server dialog.....	87
Add Camera Server dialog.....	87
Add Schedule Item dialog.....	105
Additional Options.....	110
Backlight Compensation.....	108
Continuously at Max.....	107
External Outputs Setting.....	111
Night Mode.....	109
On motion detection.....	107
On sensor event.....	107
Preset Camera Angle.....	108
Resolution.....	109
Audio Panel.....	191

B

Backup.....	213
Backup Device.....	216
Backup for Archive.....	215, 220
Backup for Data Protection.....	215, 219
Backup Tool.....	216
Configuration files.....	218
Event Data.....	217, 221
Examples.....	225
Files to Make a Backup.....	217
Restore.....	222
Temporary File.....	217
VB Settings.....	275
Video Data.....	217, 221
Before Starting Operations.....	11

C

Camera Control Panel.....	185
Exposure Mode.....	186
Focus.....	187
Pan, Tilt and Zoom.....	187
Camera Server.....	22, 85
Changing Settings.....	113
Delete.....	96
Edit.....	94
Register.....	85

Search.....	85
Cameras for Viewing.....	176
Camera Thumbnails.....	176
Locations, Zone drop-down.....	177
Selecting Locations and their Zones.....	177
Communication Mechanism.....	20
Configuration and Preferences screen..	75
Configuration Files.....	218
Continuous Recording.....	117
Control of the Camera Server.....	272

D

Daylight Savings.....	197
Disk Space Management.....	58
Calculation Example.....	61
Limit Level.....	58, 59
Low Disk Space Warning Level.....	58, 60
Threshold Level.....	59, 60

E

Event.....	62
Event Notification.....	64
Priority.....	63
Event Data.....	218
Extracting Video to Save.....	198

F

Find Camera Servers.....	85
Firmware.....	22
Upgrade.....	22
Frame Sizes.....	31

G

Get Camera Control.....	184
-------------------------	-----

H

Hard Disk.....	273
Lifetime.....	273
RAID Reconfiguration.....	273

I

Installation37
Installation Procedures.....39
Preparation and Precaution.....41
Reinstalling.....232
Restoring Previous Version.....233
Starting up the Installer39
Upgrade.....41
Introduction.....2

L

Launching the VK Viewer71, 150
Connecting to the Localhost.....72, 151
Specify the IP address of Storage
Server.....73, 152
Start-up Option.....155
Viewer Only Mode.....153
Layout.....162
Optional Layout162
Personal Layouts.....162
Shared Layouts162
Layout Grids169
Custom Grid174
Grid.....169, 170
License18
List of Messages244
Location and Zone.....78
Add.....80
Delete.....81
Edit.....81
Logs.....258
A List of Error Codes263
Storage Destination.....263

M

Manual Recording196
Master Storage Server28
Motion Detection Recording.....118
Optimization211

N

Normal Schedule.....103

Create.....104

O

Operating Environment22
Notes24
Storage Server23
Supported Camera Servers.....22
System Environment23
Operation and Management.....205
Operation Guideline208
Event Recording.....210
Live-View Frame Rate Adjustment.....208
Recording Frame Rate Adjustment209

P

Pan, Tilt and Zoom184
Preparation Flow16
Preset Tour.....132

R

Recording Schedules98
Batch-Setting.....116
Normal Schedule.....98, 103
Overview of Setting98
Recording Schedules screen99, 100
Special Day Schedule98, 136
Recording Setting Summary142
Reinstalling.....232
Restore Procedure222

S

Schedule Type137
Add.....137
Adding a Day.....139
Delete.....138
Deleting a Day.....140
Edit.....138
Searching Events201
Criteria for Searching202
Date and Time Range202
Event Search.....201
View Event in Camera.....203

Viewing Found Events.....	203
Selecting a Preset Camera Angle	187
Sensor Event Recording	125
Setting the Viewer	156
Viewer Settings window	156
Shade Correction	191
Snapshot	196
Special Day Recording.....	136
Storage and Camera Server Summary windows.....	76, 82
Storage Server	43, 82
Add.....	82
Delete	84
Edit	83
Health Check.....	207
Performance.....	33
Start-Up Method	45
Storage Server Configuration dialog	46
Storage Server Configuration dialog	46
Event Notification Tab	48, 64
Events Tab	47, 62
Settings Tab	46, 50
User Management Tab.....	49, 66
Supported Camera Servers.....	22
System Configuration	26
System Design	26
Hard Disk Capacity.....	29
Master Storage Server	28
Network Bandwidth	35
Server Sizing	29
System Configuration	26
Video Data Quantity	29
Viewer Sizing.....	34
When using multiple Storage Servers	28
When using multiple Storage Servers and Viewers.....	27
When using Viewer alone.....	28
System Operation Overview.....	18

T

Task Areas	175
Timeline.....	192
Capture Still Frame	192, 196
Extract Video	193, 198

Jump to Time.....	193, 195
Overview	192
Playback controls	192, 194
Playhead region	192, 194
Record Now.....	192, 196
Return to Live	193, 198
Zoom In or Out.....	193, 197
Troubleshooting.....	238

U

Updating	234
Camera Firmware.....	234
Upgrade.....	231
Previous Versions	231
User Management.....	66
Administrator	66, 67
User Authentication	68

V

Video Data.....	217
Video Window	176, 178, 188
Arranging Video Windows	181
Audio Panel.....	191
Camera Thumbnail.....	178
Change the Size.....	188
Control External Devices	190
Creating, scaling and moving	178
Enabling Backlight Compensation.....	189
Night mode	190
Selecting Multiple Video Windows	181
Shade Correction	190
Video Window States	182
Viewer	71, 148
Flow.....	148
Launching Procedure	71, 150
Viewer Settings window	156
Audio Transmission Settings.....	159
Configure Focus Settings	159
Configure layout in the Viewing Screen ..	158
Configure the proxy server.....	158
Edit Event Notifications	160
Identify the Master Storage Server.....	158
Saving Viewer Settings	161
Use large captions for Video Windows....	158

Viewing and Searching Events.....	199
Live Events Log list	199
Searching Events	201
VK Event Information	268
VK Events.....	207



CANON INC. — 30-2, Shimomaruko 3-chome, Ohta-ku, Tokyo 146-8501, Japan

U.S.A. — **CANON U.S.A.,INC. NEW JERSEY OFFICE**
One Canon Plaza Lake Success, NY 11042-1198 USA

- **If you have any questions, call the Canon U.S.A. Information Center toll-free at 1-800-828-4040(U.S.A.only)**

CANADA — **CANON CANADA INC.NATIONAL HEADQUARTERS**
6390 Dixie Road, Mississauga, Ontario L5T 1P7

CANON CANADA INC. CALGARY
2828, 16th Street, N.E, Calgary, Alberta T2E 7K7

CANON CANADA INC. MONTRÉAL
8801 Trans Canada Hwy, St. Laurent Québec H4S 1Z6

- **If you have any questions, call the CANON CANADA Customer Information Centre toll-free at 1-800-OK-CANON (652-2666) (Canada only)**

MEXICO — **CANON MEXICANA, S DE R.L.DE C.V.**
Boulevard Manuel Avila Camacho, No.138 PB, Pisos 15, 16 y 17 Col Lomas de Chapultepec C.P. 11000 México, D.F. México

ASIA — **CANON SINGAPORE PTE LTD**
1 HarbourFront Avenue, #04-01, Keppel Bay Tower
Singapore 098632

CANON HONGKONG CO., LTD.
19/F., The Metropolis Tower, 10 Metropolis Drive, Hunghom, Kowloon,
Hong Kong

OCEANIA — **CANON AUSTRALIA PTY. LTD.**
1 Thomas Holt Drive, North Ryde, Sydney, N.S.W. 2113, Australia

EUROPE — **CANON EUROPA N.V.**
Bovenkerkerweg 59-61, P.O. Box 2262, 1185 XB Amstelveen, The Netherlands

CANON EUROPE LTD.
6 Roundwood Avenue, Stockley Park, Uxbridge Middlesex, UB11 1JA,
United Kingdom

Free Manuals Download Website

<http://myh66.com>

<http://usermanuals.us>

<http://www.somanuals.com>

<http://www.4manuals.cc>

<http://www.manual-lib.com>

<http://www.404manual.com>

<http://www.luxmanual.com>

<http://aubethermostatmanual.com>

Golf course search by state

<http://golfingnear.com>

Email search by domain

<http://emailbydomain.com>

Auto manuals search

<http://auto.somanuals.com>

TV manuals search

<http://tv.somanuals.com>