

CTK-2500

CTK-2550

EN/ES

English

Español

USER'S GUIDE

Please keep all information for future reference.

Safety Precautions

Before trying to use the Digital Keyboard, be sure to read the separate "Safety Precautions".

GUÍA DEL USUARIO

Guarde toda la información para futuras consultas.

Precauciones de seguridad

Antes de intentar usar el teclado digital, asegúrese de leer las "Precauciones de seguridad" separadas.

About Music Score data

You can use a computer to download music score data from the CASIO Website. For more information, visit the URL below.

<http://world.casio.com/>

Acerca de los datos de partituras

Puede utilizar un ordenador (computadora) para descargar los datos de partituras desde el sitio web de CASIO. Para obtener más información, visite la siguiente URL.

<http://world.casio.com/>

NOTICE

This equipment has been tested and found to comply with the limits for a Class B digital device, pursuant to Part 15 of the FCC Rules. These limits are designed to provide reasonable protection against harmful interference in a residential installation. This equipment generates, uses and can radiate radio frequency energy and, if not installed and used in accordance with the instructions, may cause harmful interference to radio communications. However, there is no guarantee that interference will not occur in a particular installation. If this equipment does cause harmful interference to radio or television reception, which can be determined by turning the equipment off and on, the user is encouraged to try to correct the interference by one or more of the following measures:

- Reorient or relocate the receiving antenna.
- Increase the separation between the equipment and receiver.
- Connect the equipment into an outlet on a circuit different from that to which the receiver is connected.
- Consult the dealer or an experienced radio/TV technician for help.

FCC CAUTION

Changes or modifications not expressly approved by the party responsible for compliance could void the user's authority to operate the equipment.

Declaration of Conformity

Model Number: CTK-2500/CTK-2550

Trade Name: CASIO COMPUTER CO., LTD.

Responsible party: CASIO AMERICA, INC.

Address: 570 MT. PLEASANT AVENUE, DOVER, NEW JERSEY 07801

Telephone number: 973-361-5400

This device complies with Part 15 of the FCC Rules, Operation is subject to the following two conditions:

(1) This device may not cause harmful interference, and (2) this device must accept any interference received, including interference that may cause undesired operation.

Important!

Please note the following important information before using this product.

- Before using the optional AD-E95100L Adaptor to power the unit, be sure to check the AC Adaptor for any damage first. Carefully check the power cord for breakage, cuts, exposed wire and other serious damage. Never let children use an AC adaptor that is seriously damaged.
- Never attempt to recharge batteries.
- Do not use rechargeable batteries.
- Never mix old batteries with new ones.
- Use recommended batteries or equivalent types.
- Always make sure that positive (+) and negative (-) poles are facing correctly as indicated near the battery compartment.
- Replace batteries as soon as possible after any sign they are getting weak.
- Do not short-circuit the battery terminals.
- The product is not intended for children under 3 years.
- Use only CASIO AD-E95100L adaptor.
- The AC adaptor is not a toy.
- Be sure to disconnect the AC adaptor before cleaning the product.

Declaration of Conformity According to EU Directive



Manufacturer:
CASIO COMPUTER CO., LTD.
6-2, Hon-machi 1-chome, Shibuya-ku, Tokyo 151-8543, Japan

Responsible within the European Union:
Casio Europe GmbH
Casio-Platz 1, 22848 Norderstedt, Germany
www.casio-europe.com

- Any reproduction of the contents of this manual, either in part or its entirety, is prohibited. Except for your own, personal use, any other use of the contents of this manual without the consent of CASIO is prohibited under copyright laws.
- IN NO EVENT SHALL CASIO BE LIABLE FOR ANY DAMAGES WHATSOEVER (INCLUDING, WITHOUT LIMITATION, DAMAGES FOR LOSS OF PROFITS, BUSINESS INTERRUPTION, LOSS OF INFORMATION) ARISING OUT OF THE USE OF OR INABILITY TO USE THIS MANUAL OR PRODUCT, EVEN IF CASIO HAS BEEN ADVISED OF THE POSSIBILITY OF SUCH DAMAGES.
- The contents of this manual are subject to change without notice.
- The actual appearance of the product may be different from that shown in the illustrations in this User's Guide.
- Company and product names used in this manual may be registered trademarks of others.

Contents

General Guide	EN-2
Timeout	EN-4
Using the 10-key Pad (12)	EN-4
Using the FUNCTION Button (17)	EN-4
Getting Ready to Play	EN-7
Preparing the Music Stand	EN-7
Power Supply	EN-7
Playing the Digital Keyboard	EN-8
Turning on Power and Playing	EN-8
Playing the Demo Songs	EN-8
Using Headphones	EN-8
Using the Metronome	EN-8
Controlling the Keyboard Sounds	EN-9
Select from a variety of musical instrument sounds	EN-9
Using VIRTUAL HALL	EN-10
Using a Pedal	EN-10
Playing in the Dance Music Mode	EN-11
Dance Music Mode	EN-11
Switch Keyboard Functions	EN-11
Using the Dance Music Mode	EN-12
Creating a Build Up	EN-12
Dance Music Mode Settings	EN-13
Playing Built-in Songs	EN-13
Playing Back a Particular Song	EN-13
Using Built-in Songs to Master Keyboard Play	EN-15
Lesson Lite	EN-15
Settings You Can Use During Lesson Lite	EN-15
Using Auto Accompaniment	EN-16
Playing the Rhythm Part only	EN-16
Playing All Parts	EN-16
Using Auto Accompaniment Effectively	EN-18
Using One-Touch Preset	EN-18
Linking with an Application (APP Function)	EN-19
APP Function	EN-19
Downloading the Special App	EN-19
Preparing the APP Function for Use	EN-19
Using the App in the Play Mode	EN-19
Using the App in the Store Mode	EN-20
Playing Saved Data (Songs)	EN-20
Deleting Saved Data (Songs)	EN-20
Error Messages	EN-21

Connecting External Devices EN-21

Connecting to Audio Equipment	EN-21
-------------------------------	-------

Reference EN-22

Troubleshooting	EN-22
Returning the Digital Keyboard to Its Factory Default Settings	EN-23
Specifications	EN-24
Operating Precautions	EN-25

Appendix A-1

Tone List	A-1
Drum Assignment List	A-4
Rhythm List	A-5
Song List	A-6
Dance Music Mode List	A-6
Fingering Guide	A-7
Chord Example List	A-8

Included Accessories

- Music Stand
- Leaflets
 - Safety Precautions
 - Other (Warranty, etc.)

Items included as accessories are subject to change without notice.

Separately Available Accessories

- You can get information about accessories that are separately for this product from the CASIO catalog available from your retailer, and from the CASIO website at the following URL.

<http://world.casio.com/>

General Guide

- Illustrations in this User's Guide show the CTK-2500.

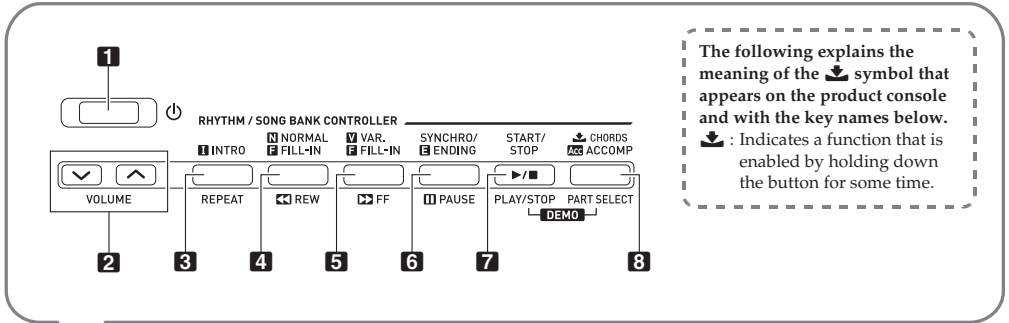

The following explains the meaning of the  symbol that appears on the product console and with the key names below.

 : Indicates a function that is enabled by holding down the button for some time.

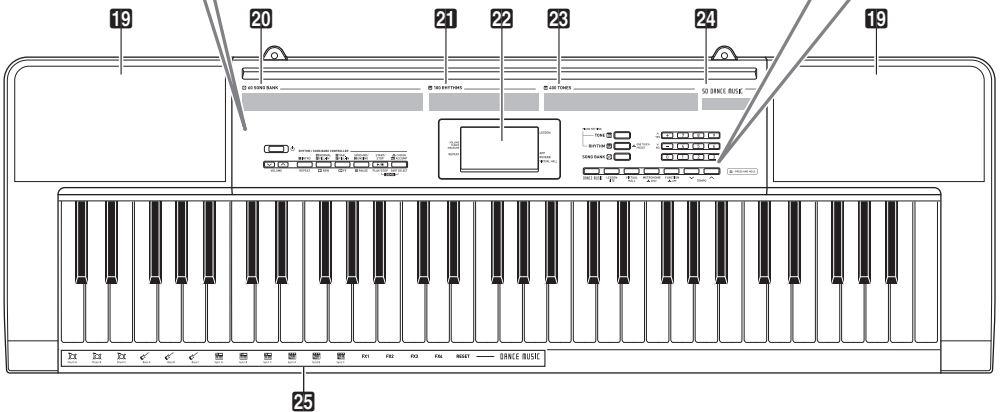
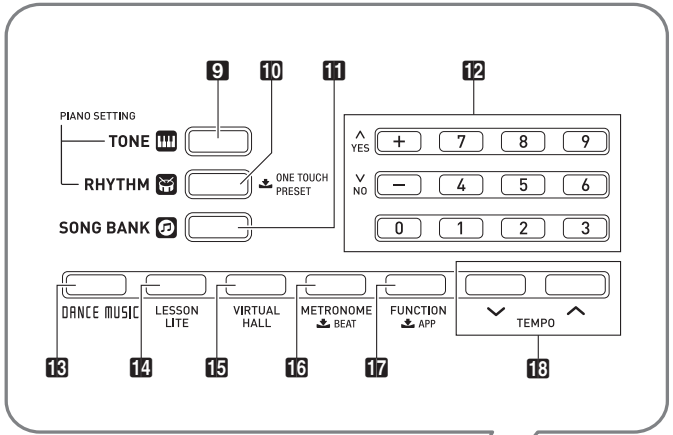

- 1** ⏻ (Power) button [EN-8](#)
- 2** VOLUME button [EN-8](#)
- 3** INTRO, REPEAT button [EN-14, 15, 18](#)
- 4** NORMAL, FILL-IN, ⏮REW button [EN-14, 18](#)
- 5** VAR., FILL-IN, ⏭FF button [EN-13, 18](#)
- 6** SYNCHRO/ENDING, ⏸PAUSE button [EN-13, 18](#)
- 7** START/STOP, PLAY/STOP button [EN-13, 14, 16, 20](#)
- 8** ⏴CHORDS, ACCOMP, PART SELECT button [EN-14, 16](#)
- 9** TONE button [EN-9, 14](#)
- 10** RHYTHM, ⏴ONE TOUCH PRESET button [EN-16, 18](#)
- 11** SONG BANK button [EN-13, 20](#)
- 12** Number buttons, [-]/[+] keys [EN-4](#)
- 13** DANCE MUSIC button [EN-12](#)
- 14** LESSON LITE button [EN-15](#)
- 15** VIRTUAL HALL button [EN-10](#)
- 16** METRONOME, ⏴BEAT button [EN-8](#)
- 17** FUNCTION, ⏴APP button [EN-4, 19](#)
- 18** TEMPO buttons [EN-9, 14](#)
- 19** Speakers
- 20** Song Bank list
- 21** Rhythm list
- 22** Display
- 23** Tone list
- 24** Dance Music Track list
- 25** Dance Music tone

■ Back

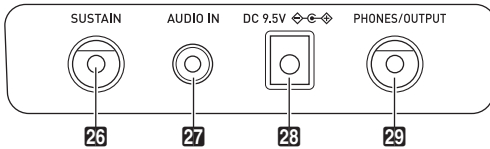

- 26** SUSTAIN jack [EN-10](#)
- 27** AUDIO IN jack [EN-19, 21](#)
- 28** DC 9.5V terminal [EN-7](#)
- 29** PHONES/OUTPUT jack [EN-8, 21](#)

■ Display

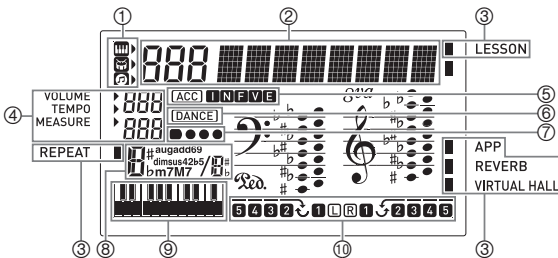

- ① Tone, rhythm, song bank indicators
 - ② Number, setting name/status display
 - ③ Indicators
 - ④ Volume, Tempo, measure
 - ⑤ I N F V E (Auto Accompaniment Types) indicators*, Acc (Auto Accompaniment) indicator
 - ⑥ Dance Music Mode indicator
 - ⑦ Beat display
 - ⑧ Chord name
 - ⑨ Pattern phrase keyboard/chord keyboard
 - ⑩ Part, fingering display
- * I: Intro, N: Normal, F: Fill-in, V: Variation, E: Ending

Timeout

If you do not perform any operation for a while configuring settings, the display will return to the previous screen automatically.

Using the 10-key Pad (12)

Use the number buttons and the [-] and [+] keys to change displayed numbers and settings.

Number Buttons

Use the number buttons to enter numbers and values.

- Enter the same number of digits as the currently displayed value.

Example: To enter tone number 004, input 0 → 0 → 4.

NOTE

- Negative values cannot be input using the number buttons. Use [+] (increase) and [-] (decrease) instead.

[-] and [+] Keys

You can use the [+] (increase) and [-] (decrease) keys to change the displayed number or value.

- Holding down either key scrolls the displayed setting.
- Pressing both keys at the same time will revert to the initial default setting or the recommended setting.

Using the FUNCTION Button (17)

Use this button to change the volume level and pitch, and to configure other settings.

1. Press **17** FUNCTION.

2. Next, press **17** FUNCTION the number of times required to select the setting you want to change.

Each press of **17** FUNCTION cycles through the available parameters.

NOTE

- You can also scroll back through settings by holding down **17** FUNCTION and pressing **18** TEMPO ∇ .

17 key presses	Parameter	Display	Description
1	Transpose	Trans.	Changes (transposes) overall instrument tuning by semitone units. -12 to +12 (semitone units, one octave up/down)
2	Accompaniment Volume	AcompVol	Changes the Auto Accompaniment volume.
3	Song Volume	Song Vol	Changes the song playback volume.
4	Dance Music Volume	DM Vol.	Changes the dance music song playback volume.
5	Dance Music Sync Type	DM Sync	Sets the timing of dance music syncing. 1: No misalignment of phrase playback between each part, regardless of pattern phrase switch timing. 2: Start pattern phrase playback to match timing of the pattern switching keyboard key. If there is misalignment with the playback timing of the pattern phrase between parts, alignment will be adjusted automatically measure-by-measure as playback proceeds.

17 key presses	Parameter	Display	Description
6	Dance Music Tempo Setting	DM Tempo	<p>Specifies whether or not the performance tempo changes to the value that is preset for each pattern.</p> <p>on: When the pattern is switched, the performance tempo changes to the tempo suggested for the selected pattern. Since the tempo changes, melody can be completely changed.</p> <p>off: Even if the pattern is switched, the performance tempo remains at its current setting, without changing.</p> <p>Tempo does not change suddenly, which enables natural pattern connection.</p>
7	Dance Music Tone Setting	DM Tone	<p>Specifies whether or not the keyboard tone changes to the tone that is preset for each pattern.</p> <p>on: When the pattern is switched, the tone changes to the tone suggested for the selected pattern. Select this setting when you want to change the performance tone whenever the pattern changes.</p> <p>off: Even if the pattern is switched, the tone remains at its current setting, without changing. Select this setting when you want the same tone to play even if the pattern changes.</p>
8	Reverb	Reverb	<p>Applies reverb to notes and specifies the reverb length.</p> <p>off: No reverb applied.</p> <p>1 to 10: A larger values applies longer reverb.</p>
9	Voice Fingering Guide	Speak	<p>Enables or disables Voice Fingering Guide, which uses a voice to tell you which finger to use to play each note during Lesson Lite.</p> <p>on: Voice Fingering Guide enabled.</p> <p>off: Voice Fingering Guide disabled.</p>
10	Note Guide	NoteGuid	<p>Enables or disables Note Guide, which sounds each note you need to play during a Lesson Lite.</p> <p>on: Note Guide enabled.</p> <p>off: Note Guide disabled.</p>
11	Performance Evaluation	Scoring	<p>Enables or disables Performance Evaluation, which displays scores for your Lesson Lite results.</p> <p>on: Performance Evaluation enabled.</p> <p>off: Performance Evaluation disabled.</p>
12	Pedal Effect	Jack	<p>Selects the effect applied by the pedal.</p> <p>Sustain (SUS): Sustains notes played while the pedal is depressed. Organ and other non-decaying tone notes are sustained as long as the pedal is depressed.</p> <p>Sostenuto (SoS): Pressing keyboard keys and then pressing this pedal before releasing them sustains them as long as the pedal is depressed.</p> <p>Soft (Sft): Slightly softens notes played while the pedal is depressed.</p> <p>Rhythm (rHy): Starts or stops Auto Accompaniment or song playback.</p>
13	Tuning	Tune	<p>Makes slight adjustments to the overall pitch. Use this feature to adjustment Digital Keyboard tuning to another musical instrument or to playback from a CD. This setting is the frequency of A4 (A above middle C). See the notes under "IMPORTANT!" below.</p> <p>415.5 to 465.9 Hz (Initial Default: 440.0 Hz)</p>

f7 key presses	Parameter	Display	Description
14	LCD Contrast	Contrast	Adjusts display contrast. 1 to 12: A larger value makes the display contrast darker.
15	Auto Power Off	APO	Setting that controls whether or not the Digital Keyboard turns off automatically after a period of non-use. OFF: Auto Power off disabled. 30: The Digital Keyboard turns off automatically after 30 minutes of non-use.

3. When the parameter you want is displayed, use **f12** (10-key) to change its setting.

! IMPORTANT!

- The tone and other parameters revert to their initial defaults whenever you turn on power. The main volume, and Tuning, LCD Contrast, and Auto Power Off settings are automatically saved and retained when power is turned off.
- You can use the [+] and [-] buttons to input a value to the right of a decimal point.
To specify 442.2 Hz, for example, first use the number buttons to input 4 → 4 → 2. Next, press the [+] button twice.

Getting Ready to Play

Preparing the Music Stand

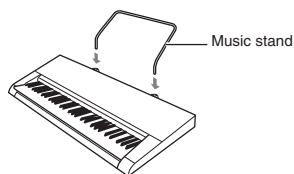

! IMPORTANT!

- Do not try to place a smart device on the Digital Keyboard's music stand. Doing so can cause the device to fall and become damaged, or can scratch flooring.

Power Supply

Either an AC adaptor or batteries can be used to power this Digital Keyboard. Normally, use of AC adaptor power is recommended.

- Depending on your geographical area, an AC adaptor may not be included. In this case, will need to purchase an AC adaptor from your retailer.

Using the AC Adaptor

Make sure that you use only the AC adaptor specified for this Digital Keyboard. Use of a different type of AC adaptor can cause malfunction.

Specified AC Adaptor: AD-E95100L
(JEITA Standard plug)

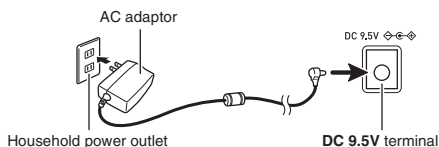

! IMPORTANT!

- Be sure to turn off Digital Keyboard power before connecting or disconnecting the AC adaptor.
- The AC adaptor will become warm to the touch after very long use. This is normal and does not indicate malfunction.
- To prevent breaking of the wire, take care to avoid putting any type of load on the power cord.

No bending!



No winding!

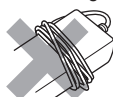

- Never insert metal, pencils, or any other objects into the product's 9.5V DC terminal. Doing so creates the risk of accident.

Using Batteries

! IMPORTANT!

- Be sure to turn off power before loading batteries.
- It is up to you to prepare six commercially available AA-size batteries. Do not use oxyride batteries or any other nickel based batteries.

1. Open the battery cover on the bottom of the Digital Keyboard.
2. Load six AA-size batteries into the battery compartment. Make sure the positive ⊕ and negative ⊖ ends of the batteries are facing as shown in the illustration.
3. Insert the tabs of the battery cover into the holes on the side of the battery compartment, and close the cover.

■ Low Battery Indication

The indicator shown below starts to flash to let you know when battery power is low. Replace the batteries with new ones.

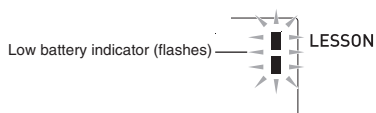

Playing the Digital Keyboard

Turning on Power and Playing

1. Press **1** (Power).

This turns on power.

- To turn off the Digital Keyboard, hold down the **1**  (Power) button until the Digital Keyboard's display goes blank.

2. Try playing something on the keyboard. You could use **2** **VOLUME** to adjust the volume setting.

- This causes the volume indicator, which shows the current volume level, to appear on the display.

IMPORTANT!

- Turning off power causes tone, rhythm, and other settings (except for main volume, the Tuning, LCD Contrast, and Auto Power Off settings) to return to their initial defaults.

Playing the Demo Songs

Following playback of the dance music demo (00), the built-in songs will playback sequentially from 01 to 60. You can switch to a different song while playback is in progress.

1. Press **7** **START/STOP, PLAY/STOP** and **8** **CHORDS, ACCOMP, PART SELECT** at the same time.

This will start playback of the demo songs. Demo playback continues until you stop it.

- Demo songs always start from song number 00 (dance music demo song).
- See page A-6 for a complete list of available songs.

2. To change to another song while demo playback is in progress, use **12** (10-key) [-] and [+] keys to enter the song number you want (page EN-4).

This will cause demo playback to jump to the song whose number you entered.

- You cannot use **12** (10-key) number buttons to select a song.

3. To stop demo playback, press **7** **START/STOP, PLAY/STOP**.

Demo playback continues until you stop it by pressing **7** **START/STOP, PLAY/STOP**.

Using Headphones

Using headphones cuts off output from the built-in speakers, which means you can practice playing even late at night without disturbing others.

- Be sure to turn down the volume level before connecting headphones.

NOTE

- Headphones do not come with the Digital Keyboard.
- Use commercially available headphones. See page EN-1 for information about options.

IMPORTANT!

- Do not listen to very high volume output over headphones for long period. Doing so creates the risk of hearing damage.
- If the plug of the headphones you are using does not match the **29** **PHONES/OUTPUT** jack, use the applicable commercially available adaptor plug.
- If you are using headphones that require an adaptor plug, make sure you do not leave the adaptor plugged in when removing the headphones.

Using the Metronome

Turning on the metronome causes the metronome tone to sound for a fixed interval in accordance with the tempo.

Start/Stop

1. Press **16** **METRONOME**.

This starts the metronome.

2. Press **16** **METRONOME** again to stop the metronome.

Changing the Beats per Measure

You can configure the metronome to use a bell sound for the first beat of each measure of the song you are playing.

- You can specify a value from 0 to 9 as the number of beat per measure.
- When playing a built-in song, the beats per measure setting (which determines when the bell sounds) is configured automatically for the currently selected song.

1. Hold down **f6** **BEAT** until the beats per measure setting screen appears on the display.
2. Use **f12** (10-key) to enter the number of beats per measure.
 - The bell will not sound if you specify 0 for this setting. In this case, all beats are indicated by a click sound. This setting lets you practice with a steady beat, without worrying how many beats there are in each measure.

Changing the Metronome Tempo

Use the following procedure to change the tempo of the metronome.

1. Press **f18** **TEMPO**.
 - Use (slower) and (faster) to change the tempo setting. Holding down either button changes the setting at high speed.
 - Pressing and at the same time will initialize the tempo setting in accordance with the currently selected song, dance music song or rhythm.
 - Pressing **f18** **TEMPO** causes the tempo indicator to appear on the display, and the tempo value starts to flash. While the tempo value is flashing, you can use **f12** (10-key) to change it.

Changing the Metronome Sound Volume

The volume level of the metronome changes along with the settings below. For information about how to change the metronome volume level in each mode, see “Using the **FUNCTION** Button (**f17**)” (page EN-4).

- Built-in song volume
- Dance music volume
- Auto Accompaniment volume

NOTE

- The balance between the metronome volume and the above settings cannot be changed.

Controlling the Keyboard Sounds

Select from a variety of musical instrument sounds

To select an instrument for playing

1. Press **f9** **TONE**.
2. Use **f12** (10-key) to select the tone number you want.
 - The corresponding tone number and tone name will appear on the screen.

NOTE

- For a list of tones, see the “Tone List” (page A-1).
- Selecting a drum set tone causes various percussion instruments to be assigned to keyboard keys.

3. Try playing something on the keyboard.
 - You can play the tone of a selected instrument.

Playing with a Piano Tone (Piano Setup)

Press **f10** **RHYTHM** and **f9** **TONE** at the same time. This selects tone 001 STEREO GRAND PIANO, and changes other settings so they are appropriate for piano performance.

Using VIRTUAL HALL

Turning on the VIRTUAL HALL function lets you play with the acoustics of a concert hall.

1. Press **F5** **VIRTUAL HALL** to turn on the VIRTUAL HALL function.
2. To turn off the VIRTUAL HALL function, press **F5** **VIRTUAL HALL** again.
 - The reverb setting turns off automatically whenever the VIRTUAL HALL function is turned on. When you turn off the VIRTUAL HALL function, the reverb setting will return to whatever it was before you turned on the VIRTUAL HALL function.

Using a Pedal

A pedal can be used to change notes in various ways while playing.

- A pedal unit does not come with the Digital Keyboard. Purchase one separately from your retailer. See page EN-1 for information about options.

Connecting a Pedal Unit

Connect an optional pedal to the **F6** **SUSTAIN** jack.

Playing in the Dance Music Mode

Dance Music Mode

In the Dance Music Mode, you can combine and play multiple type of pattern phrases, and apply effects to songs that are playing, in order to enjoy dance music.

Pattern phrases of each part can be combined, making it possible to enjoy dance music like a DJ.

Entering the Dance Music Mode (page EN-12) changes the functions of the keyboard keys as shown below.

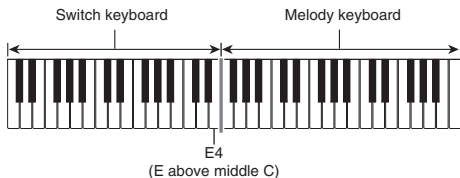

Switch Keyboard Functions

The keys of the left-half switch keyboard have the functions below.

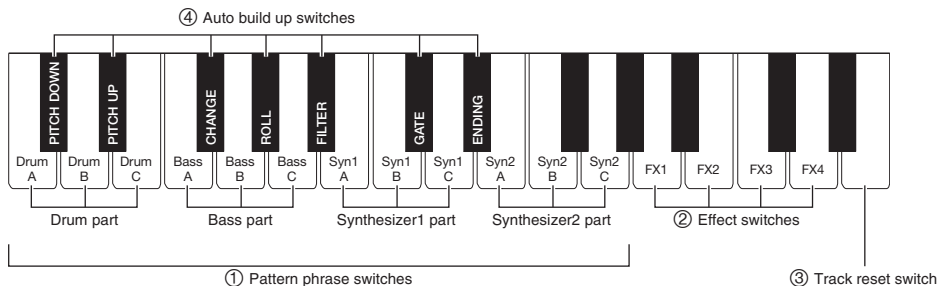

① Pattern phrase switches

These keys switch the pattern phrase and turn pattern phrases on or off.

There are four parts: Drum, Bass, Synth 1 and Synth 2, three different pattern phrases can be assigned to each.

② Effect switches

While an Effect Switch key is depressed, the corresponding effect (described below) is applied to the entire song.

Keyboard Key	Function	Effect, Description
FX1	MOD LPF*1	Cuts the high-range frequencies of the sound.
FX2	MOD HPF*2	Cuts the low-range frequencies of the sound.
FX3	FLANGER	Applies an undulating surge effect to the sound.
FX4	LO-FI	Reduces the resolution of the sound.

*1 Modulation Low Pass Filter

*2 Modulation High Pass Filter

NOTE

- The display shows the applicable function name while an effect is being applied.
- An effect is applied as long as its keyboard key is depressed, and stops being applied when the key is released.
- The application manner of MOD LPF and MOD HPF changes with the tempo.
- Effects are applied to overall pattern play, and cannot be applied to individual parts.

③ Track reset switch

Pressing this key while playback is in progress returns playback to the beginning of the currently playing phrase.

④ Auto build up switches

These keyboard keys can be used to apply build up effects that are a characteristic of dance music. See “Creating a Build Up” (page EN-12).

Using the Dance Music Mode

1. Press **F3** DANCE MUSIC.
2. Use the **F12** (10-key) [-] and [+] keys to select a pattern.

NOTE

- For a list of patterns, see the “Dance Music Mode List” (page A-6).
- Changing the pattern normally causes the tempo and tone to change to the settings configured for each pattern. If you do not want these settings to change, see “Dance Music Tempo Setting” (page EN-4) and “Dance Music Tone Setting” (page EN-4).

3. Press a ① Pattern phrase switch.

This starts pattern play.

Now you can press other part pattern phrase keys to increase the parts that are sounding, change to a different phrase, and configure other combinations.

4. Pressing a keyboard key that corresponds to a pattern phrase that is sounding stops the phrase.

- You can also start and stop pattern playback by pressing **F7** START/STOP in step 3.

NOTE

- The on-screen pattern phrase keyboard keys shows the notes being played.
- Pressing a keyboard key to which an effect is assigned applies the effect.

Changing the Melody Keyboard Tone

After pressing **F9** TONE, use the **F12** (10-key) [-] and [+] keys to select a tone for the right-half melody keyboard.

Hold down **F9** TONE to select the tone recommended for the selected pattern.

NOTE

- Press **F8** DANCE MUSIC to return to the pattern selection screen.

Changing the Tempo

You can use the tempo setting operation to change the tempo of pattern play. See “Changing the Metronome Tempo” (page EN-9).

Creating a Build Up

The build up functions can be used to create build ups while pattern play is in progress, to apply effects and build ups that are characteristic of dance music.

Function Name	Description	Remarks
PITCH	Each press of a keyboard key changes the overall pitch of the song. Pressing the PITCH DOWN key lowers the pitch in semitone units, while PITCH UP raises the pitch in semitone units.	*1
CHANGE	Instantly changes the pattern phrase of the currently playing song.	*1
ROLL	Cuts out part of a song, repeats it, and applies fine performance effects.	*2
FILTER	Applies effects that make notes darker (by cutting high-range frequencies) or brighter (by cutting low-range frequencies).	*2
GATE	Applies an effect that finely chops a song.	*2
ENDING	Ends the currently playing song while applying various effects.	*2

*1 Depending on the part, some pattern phrases are not changed.

*2 How an effect is applied changes randomly with each keyboard key press. An effect is applied for a fixed amount of time during which the on-screen pattern phrase keyboard flashes.

NOTE

- The auto build up function is executed from the next note immediately after a keyboard key is pressed.
- Though effects and the build up function can be used at the same time, the effect currently being executed may stop.
- The display shows the applicable function name while build up functions are being used.

Dance Music Mode Settings

Dance Music Volume (DM Vol.) Setting

See “Using the **FUNCTION** Button (**f17**)” (page EN-4).

Dance Music Sync Type (DM Sync) Setting

See “Using the **FUNCTION** Button (**f17**)” (page EN-4).

Dance Music Tempo (DM Tempo) Setting

See “Using the **FUNCTION** Button (**f17**)” (page EN-4).

Dance Music Tone (DM Tone) Setting

See “Using the **FUNCTION** Button (**f17**)” (page EN-4).

Playing Built-in Songs

With this Digital Keyboard, built-in music data is referred to as “songs”. You can play back songs for your listening pleasure, or for play-along practice.



- In addition to simple listening enjoyment, the built-in songs can be used with the lesson system (page EN-15) for practice.

Playing Back a Particular Song

Use the procedure below to play back one of the built-in songs. You can play along on the keyboard with song playback.

Start/Stop

- Press **f11** **SONG BANK**.
- Use **f12** (10-key) to enter the number of the song you want.
 - See page A-6 for a complete list of available songs.
- Press **f7** **START/STOP**.
This starts playback of the song.
- Press **f7** **START/STOP** again to stop playback.
Song playback will continue (repeat) until you press **f7** **START/STOP** to stop it. You can cancel song repeat by pressing **f3** **REPEAT**.

Pause, Skip Forward, Skip Back

Use the operations in this section to perform pause, skip forward, and skip back operations.

■ Pause

- Press **f6** **PAUSE**.
This pauses song playback.
- Press **f6** **PAUSE** again to resume playback from the point where you paused it.

■ Skip Forward

- Press **f5** **FF**.
This fast forwards playback of the current song. Releasing **f5** **FF** (Fast Forward) resumes playback from that location.

■ Skip Back

1. Press **4** **◀◀ REW**.

This fast reverses playback of the current song. Releasing **4** **◀◀ REW** (Fast Reverse) resumes playback from that location.

Changing Playback Speed (Tempo)

1. Press **18** **TEMPO**.

Use **∨** (slower) and **∧** (faster) to change the tempo setting. Holding down either button changes the setting at high speed.

- Pressing **∨** and **∧** at the same time will return the current song to its original default tempo.
- Pressing a **18** **TEMPO** button causes the tempo indicator to appear on the display, and the tempo value to start to flash. While the value is flashing, you can use the **12** (10-key) buttons to change it.
- Changing the song number will return the selected song to its original default tempo.

Adjusting the Song Volume

See “Using the **FUNCTION** Button (**17**)” (page EN-4).

Repeating Playback of Specific Measures

You can use the procedure in this section to repeat particular measures for practice playing along until you master it. You can specify the start measure and the end measure of the section you want to play and practice.

1. Press **3** **REPEAT** to temporarily turn off song repeat.
2. While song playback is in progress, press **3** **REPEAT** at the point where you want to start the repeat.
This specifies the measure as the start measure.
3. When playback reaches the measure you want to select as the end measure, press **3** **REPEAT** again.

This specifies the measure as the end measure and starts repeat playback of the measures in the specified range.

- During repeat play you can use **6** **|| PAUSE** to pause playback, **5** **▶▶ FF** to skip forward, or **4** **◀◀ REW** to skip back.

4. Pressing **3** **REPEAT** again returns to normal playback.
Changing the song number clears the start measure and end measure of the repeat operation.

Playing with the Same Tone as Song Playback

The same tone used by the song is assigned to the keyboard so you can play along with the song on the keyboard.

1. Hold down **9** **TONE** until the name of the tone used by the selected song appears on the display.
 - If your currently selected tone is the same as the song tone, the display contents will not change.
2. Play along with the song playback.

NOTE

- If you select a song that uses different tones for left and right hand play, the right hand part tone is assigned to the keyboard.

Turning Off the Part of One Hand for Practice (Part Select)

You can turn off the right hand part or the left hand part of a song during playback and practice playing the along with the remaining part. Use this capability when you feel that a song is initially too difficult for you to play with both hands at the same time.

1. Press **8** **PART SELECT** to select the part you want to turn off.
Each press of **8** **PART SELECT** cycles through the settings shown below.

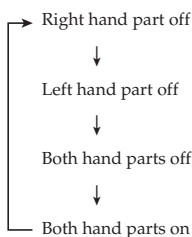

2. Press **7** **START/STOP, PLAY/STOP**.
This starts playback in accordance with the setting you selected in step 1.

Using Built-in Songs to Master Keyboard Play

Lesson Lite

With this type of lesson, notes appear on the display screen. Play notes on the keyboard in accordance with the instructions provided by Voice Fingering Guide. Don't worry if you play the wrong note. Accompaniment play will wait until you play the correct note so there is no need to hurry.

1. Select the song you want to practice (page EN-13).
2. Press **F4** LESSON LITE.
3. Play notes on the keyboard in accordance with the instructions provided on the display and by Voice Fingering Guide.

With this type of lesson, notes appear on the display screen. Voice Fingering Guide uses a simulate voice to announce which finger you should use.

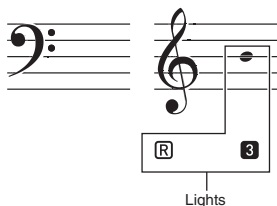

Accompaniment will wait for you to play the correct note.

- On-screen notation and sound will tell you which notes to play.
- Voice Fingering Guide will announce which finger you should use.

4. To stop the lesson, press **F4** LESSON LITE (or **F7** START/STOP, PLAY/STOP).

- If you complete lesson play to the end, a score that rates your play will appear on the screen.

Bravo!	You pass!
Again!	Go back and try again.

Settings You Can Use During Lesson Lite

Turning Off Voice Fingering Guide (Speak)

See "Using the **FUNCTION** Button (**F17**)" (page EN-4).

Turning Off Note Guide (NoteGuid)

See "Using the **FUNCTION** Button (**F17**)" (page EN-4).

Turning Off Performance Evaluation (Scoring)

See "Using the **FUNCTION** Button (**F17**)" (page EN-4).

Disabling Song Repeat

You can disable song repeat when you are practicing, if you want.

1. Press **F3** REPEAT.
This disables song repeat.

Using Auto Accompaniment

With Auto Accompaniment, simply select an accompaniment pattern. Each time you play a chord with your left hand the appropriate accompaniment will play automatically. It's like having a personal backup group along with you wherever you go.

NOTE

- Auto Accompaniments are made up of the following three parts.
 - (1) Rhythm
 - (2) Bass
 - (3) Harmony

You can have only the rhythm part play, or you can have all three parts play at the same time.

Playing the Rhythm Part only

The rhythm part is the foundation of each Auto Accompaniment. Your Digital Keyboard comes with a variety of built-in rhythms, including 8-beat and waltz. Use the following procedure to play the basic rhythm part.

Starting and Stopping the Rhythm Part only

1. Press **F10** RHYTHM.
2. Use **F12** (10-key) to select the rhythm number you want.
 - For information about rhythm types, see the "Rhythm List" (page A-5).
3. Press **F7** START/STOP or **F4** ◀◀ REW.
This starts the rhythm.
4. Play along with the rhythm.
5. To stop the rhythm, press **F7** START/STOP again.

Changing the Tempo

You can use the tempo setting operation to change the tempo of pattern play. See "Changing the Tempo" (page EN-12).

Playing All Parts

Auto Accompaniment with Chords

Playing a chord with your left hand automatically adds bass and harmony accompaniment parts to the currently selected rhythm. It is just like having your own personal backup group on call.

1. Start play of the Auto Accompaniment rhythm part.
2. Press **F8** ACCOMP.
This enables chord input on the accompaniment keyboard.

Accompaniment keyboard



3. Use the accompaniment keyboard to play chords.
This will cause bass and harmony Auto Accompaniment parts to be added to the rhythm part.
4. Play other chords with left hand as you play the melody with your right hand.
5. Pressing **F8** ACCOMP again returns to rhythm only accompaniment.

Selecting a Chord Input Mode

You can select from among the following five chord input modes.

- FINGERED 1
- FINGERED 2
- FINGERED 3
- CASIO CHORD
- FULL RANGE CHORD

1. Hold down **8** ↓ **CHORDS** until the chord input mode selection screen appears on the display.
2. Use the **12** (10-key) [-] and [+] keys to select the chord input mode you want.

■ FINGERED 1, 2, and 3

With these three input modes, you play chords on the accompaniment keyboard using their normal chord fingerings. Some chord forms are abbreviated, and can be fingered with one or two keys.

See page A-7 for information about chords that are supported and how they are fingered on the keyboard.

● FINGERED 1

Play the component notes of the chord on the keyboard.

● FINGERED 2

Unlike FINGERED 1, 6th input is not possible.

● FINGERED 3

Unlike FINGERED 1, allows input of fraction chords with the lowest keyboard note as the bass note.

■ CASIO CHORD

With CASIO CHORD, you can use simplified fingerings to play the four types of chords described below.

Chord Type

Major Chords

Pressing a single accompaniment area key in the CASIO CHORD mode will play the major chord whose name is marked above the key. All of the accompaniment area keys that are marked with the same chord name play exactly the same chord.

Example: C (C Major)



Minor Chords

To play a minor chord, press the accompaniment area key that corresponds to the major chord, while also pressing one other accompaniment area key to the right.

Example: Cm (C Minor)



Seventh Chords

To play a seventh chord, press the accompaniment area key that corresponds to the major chord, while also pressing two other accompaniment area keys to the right.

Example: C7 (C Seventh)



Minor Seventh Chords

To play a minor seventh chord, press the accompaniment area key that corresponds to the major chord, while also pressing three other accompaniment area keys to the right.

Example: Cm7 (C Minor Seventh)



NOTE

- When playing a minor, seventh, or minor seventh chord, it makes no difference whether the additional keys you press are black or white.

■ FULL RANGE CHORD

With this mode, you can use the full range of the keyboard to play chords and the melody.

See page A-7 for information about chords that are supported.

Using Auto Accompaniment Effectively

Auto Accompaniment Pattern Variations

Use the following procedures to play intro and ending patterns, to play fill-in patterns, and to play variations of basic Auto Accompaniment patterns.

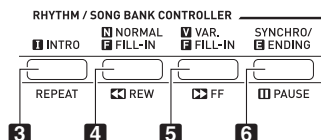

Auto Accompaniment Types	Procedure
Auto Accompaniment Variation	Press 5 . Pressing 4 returns to normal pattern.
Auto Accompaniment Intro	Press 3 . If you press 5 while an intro pattern is being played, the variation pattern will start when the intro pattern is finished.
Auto Accompaniment Fill-in	While a normal pattern is playing, press 4 . Normal pattern play will resume after the fill in pattern is complete. While a variation pattern is playing, press 5 . Variation pattern play will resume after the fill in pattern is complete.
Auto Accompaniment Ending	While an Auto Accompaniment is playing, press 6 . This will play the ending pattern and then stop Auto Accompaniment play automatically.
Using Synchro Start	Press 6 . Play a chord on the keyboard. This will start full part accompaniment (normal). Any of the following operations can be performed while in synchro standby to start a non-normal pattern. To start with intro pattern, press 3 . To start with variation pattern play, press 5 .

Using One-Touch Preset

With One-Touch Preset, the Digital Keyboard automatically configures optimal tone, tempo, and other settings in accordance with the rhythm pattern you select.

1. Hold down **10** **↓** **ONE TOUCH PRESET** until the current tone screen appears on the display.
This will automatically apply the One-Touch Preset settings in accordance with the rhythm pattern that is currently selected.
2. Play a chord on the keyboard.
This will start accompaniment automatically.

Adjusting the Accompaniment Volume

See "Using the **FUNCTION** Button (**17**)" (page EN-4).

Linking with an Application (APP Function)

APP Function

Your Digital Keyboard can connect with a smartphone, tablet, or other smart device, which can then use a special app to playback songs from other than Digital Keyboard memory. You can play along with song playback on the keyboard.

The APP function has two modes, described below.

■ Play Mode

When a song is played by the app, notes and chord names appear on the Digital Keyboard's display. You can play along with a song on the keyboard while viewing information about which keyboard keys should be pressed on the app screen. In this mode, sounds played by the app itself will sound through the Digital Keyboard's speakers, so sounds will be different from those of the Digital Keyboard.

■ Store Mode

You can transfer a song from the app to the Digital Keyboard and store it as a user song.

A stored song can be played back as you play along on the keyboard, or used in a Lesson Lite.

IMPORTANT!

- Do not send APP function data from the app while the APP function of the Digital Keyboard is not enabled.
- The sound of data transferred from the Digital Keyboard may be audible under the conditions below.
 - When using the APP function while the APP indicator is not shown on the display
 - When app instrument connection is enabled
 - When transferring song data in the Save Mode
- Since the Play Mode and Store Mode have their own characteristics, using the same song in both modes will not result in the same performance.

Downloading the Special App

Go to the website below to download the app and install it on your smart device.

<http://web.casio.com/app/>

Preparing the APP Function for Use

You need to perform the steps below to prepare the APP function for use in either the Play Mode or the Store Mode.

1. Use a commercially available audio cable to connect the  **AUDIO IN** jack of the Digital Keyboard to the headphones jack of the smart device.

IMPORTANT!

- Do not use an audio cable that adds resistance.
2. Hold down  **APP**.

This will cause the APP indicator to appear on the Digital Keyboard's display to indicate that the APP function is enabled.
 3. On the smart device, start up the app.

Using the App in the Play Mode

1. Prepare the APP function for use (page EN-19).
2. This enables app instrument connection.
3. From the song list in the app, select a song and play it.

The song will sound from the Digital Keyboard's speakers.
Chord information will appear on the Digital Keyboard display.
Play along with the song on the keyboard.

NOTE

- During song play, the same notes will sound from the left and right speakers.

Using the App in the Store Mode

1. Prepare the APP function for use (page EN-19).
2. Use **[12]** (10-key) **[-]** and **[+]** keys to select the song bank number where you want the song transferred from the app to be stored.

If you do not select a song bank number here, the Digital Keyboard will select an available storage location automatically, so you can skip this step if you do not need to specify a particular song bank number.

NOTE

- You can select one of the user song bank numbers to store a transferred song.
- The volume/tempo area of the Digital Keyboard's display shows how much user song memory has been used, while the measure area shows how much free memory is available.

3. From the song list in the app, select a song and transfer it.

After data transfer and storage are complete, the APP indicator will disappear from the display and the song bank screen will appear.

NOTE

- If the song bank number already contains data, the message "Replace?" will appear asking if you want to overwrite the existing data with the new data. Press the **[+]** (Yes) button to overwrite the existing data or the **[-]** (No) button if you do not want to overwrite.
- Normally, up to 30 songs transferred from a smart device can be stored in the song bank user song area.
- Storing songs that consist of large volumes of data may cause memory to become full before 30 songs are stored.
- The time it takes transfer a song depends on the size of the song. Transfer of most songs should take anywhere from around 10 to 30 seconds.
- Changes in app specifications may result in changes in the app's operational procedures. For details about the operation, see the app user documentation.

Playing Saved Data (Songs)

1. Press **[11]** SONG BANK and then use **[12]** (10-key) **[-]** and **[+]** keys to select a song.
2. Press **[7]** PLAY/STOP. This starts the song.

Deleting Saved Data (Songs)

1. Press **[11]** SONG BANK and then use **[12]** (10-key) **[-]** and **[+]** keys to select the song you want to delete.
 - The volume/tempo area of the Digital Keyboard's display shows how much user song memory has been used, while the measure area shows how much free memory is available.
2. Hold down **[11]** SONG BANK. This displays "DELETE?" on the display.
3. To delete the data, press the **[Yes]** (+) button.

A song delete operation cannot be undone. If you do not want to delete the song, select **[No]** (-).

Error Messages

This section explains the meanings of the error messages that appear on the display if the data transfer operation fails or if some other problem occurs. To clear an error message, pressing any button other than the power button. Note that the “EnterApp” message will disappear automatically after a few seconds if you do not perform any operation. If “ReCV Err” appears on the display when you use the Play Mode, the error message will disappear and normal operation will resume after a connection is established correctly.

Display	Cause	Action
ReCV Err	1. Disconnected audio cable. 2. App closed while it was playing data.	1. Correctly connect the audio cable and then try again. 2. Start up the app and try again.
App Vol+	App volume is too low.	Raise the volume of the app.
App Vol-	App volume is too high.	Lower the volume of the app.
Mem Full	Not enough memory capacity for song data to be transferred in the Save Mode.	Delete user songs you no longer need in order to free up memory space.
Data Err	Digital Keyboard was unable to correctly receive data sent from the app.	Try again.
EnterApp	Data received from an app while the APP function is not enabled.	Enable the APP function and try again.
Save Err	Data save failed.	Try saving to a different area.
Del Err	Data delete failed.	Try again.

Connecting External Devices

Connecting to Audio Equipment

This Digital Keyboard can be connected to commercially available stereo, amplifier, or recording equipment, to a portable audio player or other equipment.

Outputting Digital Keyboard Notes to Audio Equipment

Connect a commercially available connection cord to the **29 PHONES/OUTPUT** jack.

- The connecting cord should have a stereo standard plug on one end and a plug that matches the configuration of the input jack of the external device on the other end.

IMPORTANT!

- Turn off the external device when making connections. After connecting, turn down the Digital Keyboard and external device volume levels whenever turning power on or off.
- After connecting, turn on the Digital Keyboard and then the external device.
- If Digital Keyboard notes sound distorted when they are sounded from external audio equipment, lower the Digital Keyboard's volume setting.

Playing an External Device from the Digital Keyboard

Connect a commercially available connection cord to the **27 AUDIO IN** jack.

- The connecting cord should have a stereo mini plug on one end and a plug that matches the configuration of the output jack of external device on the other end.

IMPORTANT!

- Notes from an external device may not sound normally if the Digital Keyboard's APP function is enabled.
- Turn off the Digital Keyboard when making connections. After connecting, turn down the Digital Keyboard and external device volume levels whenever turning power on or off.
- After connecting, turn on the external device and then the Digital Keyboard.
- If notes are distorted when they are sounded on the external device, lower the volume setting of the external device.

Troubleshooting

Symptom	Action
Included Accessories	
I can't find something that should be here.	Carefully check inside all of the packing materials.
Power Requirements	
Power will not turned on.	<ul style="list-style-type: none"> • Check the AC adaptor or make sure that the batteries are facing correctly (page EN-7). • Replace the batteries with new ones or switch over to AC adaptor power (page EN-7).
The Digital Keyboard outputs a loud sound and then suddenly powers down.	Replace the batteries with new ones or switch over to AC adaptor power (page EN-7).
The Digital Keyboard suddenly powers down after 30 minutes.	This happens when Auto Power Off (page EN-4) is triggered.
Display	
The display keeps going out or are flashing.	Replace the batteries with new ones or switch over to AC adaptor power (page EN-7).
On-screen keyboard keys or notes remain on the display.	A Lesson Lite is in progress and the Digital Keyboard is waiting for you to play the next note in the song. To stop this from happening, cancel the lesson (page EN-15).
Screen contents are visible only from straight ahead.	This is dues to production limitations. It does not indicate malfunction.
While the APP function is being used, on-screen notation and chord information sometimes go blank.	This happens when invalid data is received. It does not indicate malfunction. Check to make sure that the app is connected correctly.
Sound	
Nothing happens when I press any keyboard key.	<ul style="list-style-type: none"> • Adjust the main volume setting (page EN-8). • Check if something is plugged into the PHONES/OUTPUT jack (2) on the back of the Digital Keyboard. • Turn power off and then back on to initialize all Digital Keyboard settings (page EN-8).
Nothing happens or notes do not play normally when I play notes on the left side of the keyboard.	Press 8 ACCOMP to disable chord input in the accompaniment keyboard area (page EN-16).
Nothing happens when I start an Auto Accompaniment.	<ul style="list-style-type: none"> • With rhythms 096 to 100, nothing will sound until you play a chord on the keyboard. Try playing a chord (page EN-17). • Check and adjust the accompaniment volume setting (page EN-18). • Turn power off and then back on to initialize all Digital Keyboard settings (page EN-8).
Nothing happens when I start playback of a built-in song.	<ul style="list-style-type: none"> • It takes a little time after you press the button until the song starts to play. Wait for a moment for the song to start. • Check and adjust the song volume (page EN-14). • Turn power off and then back on to initialize all Digital Keyboard settings (page EN-8).
The metronome does not sound.	<ul style="list-style-type: none"> • Check and adjust the accompaniment volume setting (page EN-4). • Check and adjust the song volume (page EN-4). • Check the dance music song volume level (page EN-4) and adjust it as required. • Turn power off and then back on to initialize all Digital Keyboard settings (page EN-8).
Notes keep sounding, without stopping.	<ul style="list-style-type: none"> • Turn power off and then back on to initialize all Digital Keyboard settings (page EN-8). • Replace the batteries with new ones or switch over to AC adaptor power (page EN-7).

Symptom	Action
Some notes are cut off while they are playing.	Notes are cut off whenever the number of notes being sounded exceeds the maximum polyphony value of 48 (24 for some tones). This does not indicate malfunction.
The volume or tone setting I made has changed.	<ul style="list-style-type: none"> Adjust the main volume setting (page EN-8). Turn power off and then back on to initialize all Digital Keyboard settings (page EN-8). Replace the batteries with new ones or switch over to AC adaptor power (page EN-7).
In certain keyboard ranges, the volume and tone quality sound are slightly different from those in other keyboard ranges.	This is due to system limitations. It does not indicate malfunction.
With some tones, octaves do not change at the far ends of the keyboard.	This is due to system limitations. It does not indicate malfunction.
The pitch of the notes does not match other accompanying instruments or sounds strange when played long with other instruments.	<ul style="list-style-type: none"> Check and adjust the transpose (page EN-4) and tuning settings (page EN-4). Turn power off and then back on to initialize all Digital Keyboard settings (page EN-8).
The reverb of notes seems to change suddenly.	<ul style="list-style-type: none"> Check and adjust the reverb setting (page EN-4). Turn power off and then back on to initialize all Digital Keyboard settings (page EN-8).
Operation	
When I perform a skip forward or skip back operation, the skip operation moves multiple song measures instead of only a single measure.	While song playback is stopped or a Lesson Lite is in progress, skip forward and skip back operations are performed in song units (page EN-13).
APP function data transfer failed.	Look up the meaning of the error message (page EN-21) and take the appropriate corrective steps.

Returning the Digital Keyboard to Its Factory Default Settings

Perform the following procedure when you want to return the Digital Keyboard's stored data and settings to their initial factory defaults.

1. Turn off the Digital Keyboard.
2. While holding down **f1** **SONG BANK** and the [0] 10-key (**f12**) key at the same time, press **f1** **⏻** (Power).
 - You will be able to use the Digital Keyboard in a short while after its system is initialized.

Specifications

Model	CTK-2500/CTK-2550
Keyboard	61 keys
Maximum Polyphony	48 notes
Tones	
Preset Tones	400; 1 stereo piano tone
Effects	Reverb (10 types, Off), Dance Music effects, Virtual Hall
Metronome	
Beat	Off, 1 to 9 beats
Tempo	20 to 255
Song Bank	
Preset Songs	60
User Songs	Up to 30/Total Memory Capacity: Approximately 32 kilobytes (1 kilobyte = 1,024 bytes)
Lesson Lite	
Lesson Parts	Left hand, right hand, both hands
Other	Repeat, Voice Fingering Guide, Note Guide, Performance Evaluation
Auto Accompaniment	
Preset Rhythms	100 types
One Touch Presets	100 types
Dance Music Mode	
Preset Patterns	50 types
Demo Function	Looped play of the dance music demo (1 song) and built-in Song Bank (60 songs)
Other Functions	
Transpose	±1 octave (-12 to 0 to +12 semitones)
Tuning	A4 = 415.5 to 465.9Hz (Initial Default: 440.0Hz)
Musical Information System	Tone, Auto Accompaniment, Song Bank numbers and names; staff notation; fingering guide; pedal; tempo; measure number, beat; chord name, etc.
APP Function	
Supported Devices	iOS, Android (connected via the audio input terminal)
Jacks	
Sustain jack	Standard jack (sustain, sostenuto, soft, rhythm)
PHONES/OUTPUT jack	Stereo standard jack × 1 Output impedance: 140 Ω; Output voltage: 4.5 V (RMS) MAX
AUDIO IN jack	Stereo mini jack Input impedance: 9 kΩ; Input sensitivity: 200 mV
AC adaptor terminal	9.5 V DC
Power Requirements	2-Way Power
Batteries	Six AA-size manganese batteries or AA-size alkaline batteries
Battery Life	Approximately 12 hours (on alkaline batteries)
AC Adaptor	AD-E95100L
Auto Power Off	Approximately 30 minutes after last operation; Can be disabled.
Speakers	10cm × 2 (Output: 2.0W+2.0W)
Power Consumption	9.5V --- 5.5W
Dimensions	94.6 (W) × 30.7 (D) × 9.2 (H) cm (37 1/4 × 12 1/8 × 3 5/8 inch)
Weight (Excluding batteries)	Approximately 3.3 kg (7.3 lbs)

- Design and specifications are subject to change without notice.

Operating Precautions

Be sure to read and observe the following operating precautions.

■ Location

Avoid the following locations for this product.

- Areas exposed to direct sunlight and high humidity
- Areas subjected to temperature extremes
- Near a radio, TV, video deck, or tuner

The above devices will not cause malfunction of the product, but interference from the product can cause audio or video interference of a nearby device.

■ User Maintenance

- Never use benzine, alcohol, thinner, or other chemical agents to clean the product.
- To clean the product or its keyboard, wipe with a soft cloth moistened in a weak solution of water and a mild neutral detergent. Wring all excess moisture from the cloth before wiping.

■ Included and Optional Accessories

Use only accessories that are specified for use with this product. Use of unauthorized accessories creates the risk of fire, electric shock, and personal injury.

■ Weld Lines

Lines may be visible on the exterior of the product. These are “weld lines” that result from the plastic molding process. They are not cracks or scratches.

■ Musical Instrument Etiquette

Always be aware of others around you whenever using this product. Be especially careful when playing late at night to keep the volume at levels that do not disturb others. Other steps you can take when playing late at night are closing the window and using headphones.

Appendix/Apéndice

Tone List/Lista de tonos

No./ N°	Tone Name/ Nombre del tono	Program Change/ Cambio de programa	Bank Select MSB/ MSB de selección de banco
PIANO			
001	STEREO GRAND PIANO	0	2
002	GRAND PIANO	0	1
003	BRIGHT PIANO	1	2
004	MODERN PIANO	1	3
005	DANCE PIANO	1	1
006	MELLOW PIANO	0	3
007	STRINGS PIANO	0	8
008	HONKY-TONK	3	2
009	OCTAVE PIANO	3	9
010	BASS/PIANO	0	9
011	ELEC.GRAND PIANO	2	2
012	MODERN E.G.PIANO	2	3
013	HARPSICHORD	6	2
014	HARPSICHORD & STRINGS	6	1
ELECTRIC PIANO			
015	ELEC.PIANO	4	2
016	FM E.PIANO	5	5
017	60'S E.PIANO	4	5
018	CHORUS E.PIANO 1	4	9
019	CHORUS E.PIANO 2	4	6
020	MODERN E.PIANO	5	2
021	SOFT E.PIANO	4	8
022	SYNTH-STR.E.PIANO	4	3
023	CLEAN E.PIANO	4	4
024	CLAVI 1	7	2
025	CLAVI 2	7	3
026	SOFT CLAVI	7	1
027	DETUNE CLAVI	7	8
028	SEQUENCE CLAVI	7	9
CHROMATIC PERC.			
029	VIBRAPHONE 1	11	2
030	VIBRAPHONE 2	11	1
031	SOFT VIBRAPHONE 1	11	3
032	SOFT VIBRAPHONE 2	11	4
033	MARIMBA	12	2
034	SOFT MARIMBA	12	1
035	CELESTA 1	8	2
036	CELESTA 2	8	1
037	GLOCKENSPIEL	9	2
038	MUSIC BOX 1	10	2
039	MUSIC BOX 2	10	1
040	XYLOPHONE	13	2
041	TUBULAR BELL	14	2
042	DULCIMER	15	2
ORGAN			
043	DRAWBAR ORGAN 1	16	2
044	DRAWBAR ORGAN 2	16	1
045	PERC.ORGAN 1	17	2
046	PERC.ORGAN 2	17	3
047	ELEC.ORGAN 1	16	8
048	ELEC.ORGAN 2	16	4
049	JAZZ ORGAN 1	17	4
050	JAZZ ORGAN 2	17	6
051	ROCK ORGAN 1	18	2
052	ROCK ORGAN 2	18	1
053	FULL DRAWBAR	16	9
054	CLICK ORGAN	18	7
055	8'ORGAN	17	5
056	CHURCH ORGAN 1	19	2
057	CHURCH ORGAN 2	19	3
058	CHAPEL ORGAN	19	8
059	THEATER ORGAN	19	6
060	REED ORGAN	20	2
061	ACCORDION	21	2
062	BANDONEON	23	2
063	HARMONICA 1	22	2
064	HARMONICA 2	22	8

No./ N°	Tone Name/ Nombre del tono	Program Change/ Cambio de programa	Bank Select MSB/ MSB de selección de banco
GUITAR			
065	NYLON STR.GUITAR	24	2
066	STEEL STR.GUITAR	25	2
067	12 STR.GUITAR	25	8
068	CHORUS STEEL GT	25	9
069	JAZZ GUITAR	26	2
070	OCT.JAZZ GUITAR	26	8
071	CLEAN GUITAR 1	27	2
072	CLEAN GUITAR 2	27	1
073	MUTE GUITAR	28	2
074	OVERDRIVE GUITAR	29	2
075	DISTORTION GUITAR	30	2
076	POWER DIST.GUITAR	30	5
077	FEEDBACK GUITAR	31	8
078	DIST.GUITAR & BASS	30	6
BASS			
079	ACOUSTIC BASS	32	2
080	FINGERED BASS	33	2
081	PICKED BASS	34	2
082	FRETLESS BASS	35	2
083	SLAP BASS	37	2
084	SAW SYNTH-BASS	38	2
085	SQUARE SYNTH-BASS	39	2
086	DIGI ROCK BASS	39	1
087	TRANCE BASS	38	4
088	SINE BASS	39	6
STR/ORCHESTRA			
089	VIOLIN	40	2
090	SLOW VIOLIN	40	8
091	VIOLA	41	2
092	CELLO	42	2
093	SLOW CELLO	42	1
094	CONTRABASS	43	2
095	VIOLIN & CELLO	40	3
096	CELLO SECTION	42	4
097	PIZZICATO STRINGS	45	2
098	HARP 1	46	2
099	HARP 2	46	1
100	CHORUS HARP	46	8
ENSEMBLE			
101	STRINGS	48	2
102	SLOW STRINGS	49	2
103	WIDE STRINGS	48	16
104	CHAMBER	48	3
105	OCTAVE STRINGS	48	32
106	STRINGS SFZ	48	8
107	TREMOLO STRINGS	49	1
108	FLUTE & STRINGS	49	3
109	CHOIR STRINGS	52	3
110	SYNTH-STRINGS 1	50	2
111	SYNTH-STRINGS 2	51	2
112	SYNTH-STRINGS 3	51	3
113	FAST SYNTH-STRINGS	50	3
114	CHOIR AAHS	52	2
115	VOICE DOO	53	2
116	SYNTH-VOICE	54	2
117	SYNTH-VOICE PAD	54	8
118	CHORUS SYNTH-VOICE	54	9
119	ORCHESTRA HIT 1	55	2
120	ORCHESTRA HIT 2	55	1
BRASS			
121	TRUMPET	56	2
122	MELLOW TRUMPET	56	8
123	TRUMPET SFZ	56	1
124	TROMBONE	57	2
125	TUBA	58	2
126	MUTE TRUMPET	59	2
127	FRENCH HORN	60	2

No./ N°	Tone Name/ Nombre del tono	Program Change/ Cambio de programa	Bank Select MSB/ MSB de selección de banco
128	FRENCH HORN SECTION	60	1
129	BRASS	61	2
130	BRASS SECTION 1	61	3
131	BRASS SECTION 2	61	6
132	BRASS SECTION 3	61	7
133	MELLOW BRASS	61	1
134	HARD BRASS	61	5
135	BRASS SFZ	61	8
136	BRASS & STRINGS	61	4
137	SYNTH-BRASS 1	62	2
138	SYNTH-BRASS 2	63	2
139	ANALOG SYNTH-BRASS 1	62	8
140	ANALOG SYNTH-BRASS 2	62	9
REED/PIPE			
141	ALTO SAX 1	65	1
142	ALTO SAX 2	65	2
143	HARD A.SAX	65	3
144	BREATHY A.SAX	65	8
145	TENOR SAX	66	1
146	SOPRANO SAX 1	64	2
147	SOPRANO SAX 2	64	1
148	BARITONE SAX 1	67	2
149	BARITONE SAX 2	67	1
150	SAX SECTION	65	9
151	CLARINET	71	2
152	OBOE	68	2
153	SOLO OBOE	68	4
154	BASSOON	70	5
155	FLUTE 1	73	2
156	FLUTE 2	73	1
157	PURE FLUTE	73	8
158	PICCOLO	72	2
159	RECORDER	74	2
160	PAN FLUTE	75	2
161	BOTTLE BLOW 1	76	2
162	BOTTLE BLOW 2	76	1
163	WHISTLE	78	2
164	OCARINA	79	2
165	FLUTE & OBOE	73	3
SYNTH-LEAD			
166	SQUARE LEAD 1	80	2
167	SQUARE LEAD 2	80	3
168	SQUARE LEAD 3	80	1
169	SAW LEAD 1	81	2
170	SAW LEAD 2	81	1
171	SAW LEAD 3	81	5
172	MELLOW SAW LEAD	81	8
173	SQUARE PULSE LEAD	80	5
174	SEQUENCE SAW	81	9
175	SEQUENCE SINE	80	9
176	SINE LEAD	80	8
177	SS LEAD	81	3
178	SEQUENCE SQUARE	80	7
179	SEQUENCE PULSE	80	16
180	SLOW SAW LEAD	81	4
181	CALLIOPE	82	2
182	VENT LEAD	82	5
183	VENT SYNTH	82	1
184	CHIFF LEAD	83	2
185	SEQUENCE LEAD 1	83	5
186	SEQUENCE LEAD 2	83	3
187	VOICE LEAD	85	2
188	DISTORTION LEAD	84	8
189	CHARANG	84	2
190	CHURCH LEAD	85	4
191	SYNTH-VOICE LEAD	85	7
192	FIFTH LEAD	86	4
193	FIFTH SAW LEAD	86	2
194	FIFTH SQUARE LEAD	86	3
195	FIFTH SEQUENCE	86	1
196	BASS-LEAD	87	2

No./ N°	Tone Name/ Nombre del tono	Program Change/ Cambio de programa	Bank Select MSB/ MSB de selección de banco
197	DANCE SQUARE LEAD	80	48
198	DANCE SYNC SQUARE LEAD	80	49
199	DANCE SAW LEAD	81	48
200	DANCE SYNC SAW LEAD	81	49
201	DANCE POLY SAW LEAD	81	50
202	DANCE SAW BASS	87	48
SYNTH-PAD			
203	FANTASY 1	88	2
204	FANTASY 2	88	3
205	WARM VOX	89	8
206	WARM PAD	89	2
207	SINE PAD	89	3
208	SOFT PAD	89	4
209	OLD TAPE PAD	89	6
210	POLYSYNTH 1	90	2
211	POLYSYNTH 2	90	1
212	POLY SAW	90	8
213	SPACE CHOIR	91	1
214	HEAVEN	91	2
215	SQUARE PAD	92	1
216	BOWED PAD	92	2
217	GLASS PAD	92	3
218	ETHNIC PAD	93	2
219	HARD METAL PAD	93	4
220	CHORUS PAD	94	1
221	HALO PAD	94	2
222	SWEEP PAD	95	2
223	RAIN DROP	96	2
224	SPACE VOICE	97	1
225	SOUND TRACK 1	97	2
226	SOUND TRACK 2	97	3
227	RAVE	97	8
228	CRYSTAL	98	2
229	CHORAL BELL	98	16
230	CELESTA PAD	99	1
231	ATMOSPHERE	99	2
232	BRIGHT BELL PAD	100	1
233	BRIGHTNESS	100	2
234	GOBLIN	101	2
235	ECHO PAD	102	2
236	ECHO DROP	102	3
237	POLY DROP	102	4
238	STAR THEME	103	2
239	SPACE PAD	103	8
240	DANCE SAW PAD	90	48
241	DANCE SQUARE PAD 1	90	49
242	DANCE SQUARE PAD 2	90	50
INDIAN			
243	SITAR 1	104	2
244	SITAR 2	104	3
245	TANPURA 1	104	32
246	TANPURA 2	104	33
247	HARMONIUM 1	20	32
248	HARMONIUM 2	20	33
249	SHANAI 1	111	2
250	SHANAI 2	111	3
251	SANTUR 1	15	3
252	SANTUR 2	15	4
253	TABLA	116	16
ETHNIC			
254	YANG QIN 1	15	8
255	YANG QIN 2	15	9
256	DI ZI	72	16
257	ZHENG	107	1
258	SHENG	109	8
259	SUO NA	111	32
260	XIAO	77	32
261	PI PA	105	32
262	BANJO	105	2
263	THUMB PIANO	108	2
264	STEEL DRUMS	114	2

No./ N°	Tone Name/ Nombre del tono	Program Change/ Cambio de programa	Bank Select MSB/ MSB de selección de banco
265	RABAB	105	8
266	KOTO	107	2
GM TONES			
267	GM PIANO 1	0	0
268	GM PIANO 2	1	0
269	GM PIANO 3	2	0
270	GM HONKY-TONK	3	0
271	GM E.PIANO 1	4	0
272	GM E.PIANO 2	5	0
273	GM HARPSICHORD	6	0
274	GM CLAVI	7	0
275	GM CELESTA	8	0
276	GM GLOCKENSPIEL	9	0
277	GM MUSIC BOX	10	0
278	GM VIBRAPHONE	11	0
279	GM MARIMBA	12	0
280	GM XYLOPHONE	13	0
281	GM TUBULAR BELL	14	0
282	GM DULCIMER	15	0
283	GM ORGAN 1	16	0
284	GM ORGAN 2	17	0
285	GM ORGAN 3	18	0
286	GM PIPE ORGAN	19	0
287	GM REED ORGAN	20	0
288	GM ACCORDION	21	0
289	GM HARMONICA	22	0
290	GM BANDONEON	23	0
291	GM NYLON STR.GUITAR	24	0
292	GM STEEL STR.GUITAR	25	0
293	GM JAZZ GUITAR	26	0
294	GM CLEAN GUITAR	27	0
295	GM MUTE GUITAR	28	0
296	GM OVERDRIVE GUITAR	29	0
297	GM DISTORTION GUITAR	30	0
298	GM GUITAR HARMONICS	31	0
299	GM ACOUSTIC BASS	32	0
300	GM FINGERED BASS	33	0
301	GM PICKED BASS	34	0
302	GM FRETLESS BASS	35	0
303	GM SLAP BASS 1	36	0
304	GM SLAP BASS 2	37	0
305	GM SYNTH-BASS 1	38	0
306	GM SYNTH-BASS 2	39	0
307	GM VIOLIN	40	0
308	GM VIOLA	41	0
309	GM CELLO	42	0
310	GM CONTRABASS	43	0
311	GM TREMOLO STRINGS	44	0
312	GM PIZZICATO	45	0
313	GM HARP	46	0
314	GM TIMPANI	47	0
315	GM STRINGS 1	48	0
316	GM STRINGS 2	49	0
317	GM SYNTH-STRINGS 1	50	0
318	GM SYNTH-STRINGS 2	51	0
319	GM CHOIR AAHS	52	0
320	GM VOICE DOO	53	0
321	GM SYNTH-VOICE	54	0
322	GM ORCHESTRA HIT	55	0
323	GM TRUMPET	56	0
324	GM TROMBONE	57	0
325	GM TUBA	58	0
326	GM MUTE TRUMPET	59	0
327	GM FRENCH HORN	60	0
328	GM BRASS	61	0
329	GM SYNTH-BRASS 1	62	0
330	GM SYNTH-BRASS 2	63	0
331	GM SOPRANO SAX	64	0
332	GM ALTO SAX	65	0
333	GM TENOR SAX	66	0
334	GM BARITONE SAX	67	0

No./ N°	Tone Name/ Nombre del tono	Program Change/ Cambio de programa	Bank Select MSB/ MSB de selección de banco
335	GM OBOE	68	0
336	GM ENGLISH HORN	69	0
337	GM BASSOON	70	0
338	GM CLARINET	71	0
339	GM PICCOLO	72	0
340	GM FLUTE	73	0
341	GM RECORDER	74	0
342	GM PAN FLUTE	75	0
343	GM BOTTLE BLOW	76	0
344	GM SHAKUHACHI	77	0
345	GM WHISTLE	78	0
346	GM OCARINA	79	0
347	GM SQUARE LEAD	80	0
348	GM SAW LEAD	81	0
349	GM CALLIOPE	82	0
350	GM CHIFF LEAD	83	0
351	GM CHARANG	84	0
352	GM VOICE LEAD	85	0
353	GM FIFTH LEAD	86	0
354	GM BASS+LEAD	87	0
355	GM FANTASY	88	0
356	GM WARM PAD	89	0
357	GM POLYSYNTH	90	0
358	GM SPACE CHOIR	91	0
359	GM BOWED GLASS	92	0
360	GM METAL PAD	93	0
361	GM HALO PAD	94	0
362	GM SWEEP PAD	95	0
363	GM RAIN DROP	96	0
364	GM SOUND TRACK	97	0
365	GM CRYSTAL	98	0
366	GM ATMOSPHERE	99	0
367	GM BRIGHTNESS	100	0
368	GM GOBLINS	101	0
369	GM ECHOES	102	0
370	GM SF	103	0
371	GM SITAR	104	0
372	GM BANJO	105	0
373	GM SHAMISEN	106	0
374	GM KOTO	107	0
375	GM THUMB PIANO	108	0
376	GM BAGPIPE	109	0
377	GM FIDDLE	110	0
378	GM SHANAI	111	0
379	GM TINKLE BELL	112	0
380	GM AGOGO	113	0
381	GM STEEL DRUMS	114	0
382	GM WOOD BLOCK	115	0
383	GM TAIKO	116	0
384	GM MELODIC TOM	117	0
385	GM SYNTH-DRUM	118	0
386	GM REVERSE CYMBAL	119	0
387	GM GUITAR FRET NOISE	120	0
388	GM BREATH NOISE	121	0
389	GM SEASHORE	122	0
390	GM BIRD	123	0
391	GM TELEPHONE	124	0
392	GM HELICOPTER	125	0
393	GM APPLAUSE	126	0
394	GM GUNSHOT	127	0
DRUM SET			
395	STANDARD SET 1	0	120
396	STANDARD SET 2	1	120
397	DANCE SET	29	120
398	BRUSH SET	40	120
399	ORCHESTRA SET	48	120
400	INDIAN SET	49	120

Drum Assignment List/Lista de asignación de batería

Key/ Clave	Note No./ Nº de nota	DRUMS SET NAME					
		STANDARD SET 1	STANDARD SET 2	DANCE SET	BRUSH SET	ORCHESTRA SET	INDIAN SET
C-1	0						
D-1	1						
E-1	2						
F-1	3						
G-1	4						
A-1	5						
B-1	6						
C0	7						
D0	8						
E0	9						
F0	10						
G0	11						
A0	12						
B0	13						
C1	14						
D1	15						
E1	16						
F1	17						
G1	18						
A1	19						
B1	20						
C2	21						
D2	22						
E2	23						
F2	24						
G2	25						
A2	26						
B2	27						
C3	28						
D3	29						
E3	30						
F3	31						
G3	32						
A3	33						
B3	34						
C4	35						
D4	36						
E4	37						
F4	38						
G4	39						
A4	40						
B4	41						
C5	42						
D5	43						
E5	44						
F5	45						
G5	46						
A5	47						
B5	48						
C6	49						
D6	50						
E6	51						
F6	52						
G6	53						
A6	54						
B6	55						
C7	56						
D7	57						
E7	58						
F7	59						
G7	60						
A7	61						
B7	62						
C8	63						
D8	64						
E8	65						
F8	66						
G8	67						
A8	68						
B8	69						
C9	70						
D9	71						
E9	72						
F9	73						
G9	74						
	75						
	76						
	77						
	78						
	79						
	80						
	81						
	82						
	83						
	84						
	85						
	86						
	87						
	88						
	89						
	90						
	91						
	92						
	93						
	94						
	95						
	96						
	97						
	98						
	99						
	100						
	101						
	102						
	103						
	104						
	105						
	106						
	107						
	108						
	109						
	110						
	111						
	112						
	113						
	114						
	115						
	116						
	117						
	118						
	119						
	120						
	121						
	122						
	123						
	124						
	125						
	126						
	127						

- “←” indicates a key is assigned the same tones as it is for STANDARD SET 1.
- “←” indica una clave asignada a los mismos tonos que para STANDARD SET 1.

Rhythm List/Lista de ritmos

No./N°	Rhythm name/ Nombre del ritmo
8 BEAT	
001	STRAIGHT 8 BEAT
002	8 BEAT POP
003	8 BEAT
16 BEAT	
004	16 BEAT
005	16 BEAT SHUFFLE 1
006	16 BEAT SHUFFLE 2
BALLAD	
007	MODERN BALLAD
008	16 BEAT BALLAD
009	POP BALLAD
010	6/8 BALLAD
DANCE	
011	EDM 1
012	EDM 2
013	DISCO POP
014	MODERN R&B
015	DISCO SOUL
POPS	
016	POP
017	POP ROCK
018	FAST SOUL
019	SLOW SOUL
020	60's SOUL
ROCK	
021	STRAIGHT ROCK
022	SHUFFLE ROCK
023	LATIN ROCK
024	SLOW ROCK
025	NEW ORLNS R&R
026	ROCK WALTZ
JAZZ	
027	SLOW BIG BAND
028	MIDDLE BIG BAND
029	FAST BIG BAND
030	SWING
031	SLOW SWING
032	JAZZ WALTZ
033	FOX TROT
EUROPEAN	
034	POLKA
035	WALTZ 1
036	SLOW WALTZ
037	VIENNESE WALTZ
038	FRENCH WALTZ
039	TANGO
040	MARCH 1
041	MARCH 2
LATIN	
042	BOSSA NOVA
043	SAMBA
044	MAMBO
045	RHUMBA
046	CHA-CHA-CHA
047	MERENGUE
048	BOLERO
049	SALSA
050	REGGAE
051	POP REGGAE

No./N°	Rhythm name/ Nombre del ritmo
052	SKA
053	CUMBIA
INDIAN	
054	BHANGRA
055	DADRA
056	GARBA
057	KEHARWA
058	TEEN TAAL
059	DANDIYA
060	BHAJAN
061	INDIAN POP 1
062	INDIAN POP 2
063	QAWWALI
064	KERALA
065	RAJASTHANI
WORLD	
AMERICAN	
066	COUNTRY BALLAD
067	BLUEGRASS
068	DIXIE
069	TEX-MEX
070	FAST GOSPEL
071	HAWAIIAN
SPANISH/EASTERN EUROPEAN	
072	FOLKLORE
073	RUSSIAN CHANSON
ARABIC/ORIENTAL	
074	SIRTAKI
075	MUS
076	ADANI
077	KHALIJI
078	MALFOUF
CHINESE	
079	JIANGNAN
080	DONGBEIYANGGE
081	JINGJU
082	HUANGMEIXI
083	MIAOZU
084	XINJIANG
SOUTHEAST ASIAN	
085	KRONCONG
086	DANGDUT
JAPANESE	
087	ENKA
VARIOUS	
088	CHRISTMAS SONG
089	CHRISTMAS WALTZ
090	STR QUARTET
PIANO RHYTHMS	
091	PIANO 8 BEAT
092	PIANO BALLAD
093	EP BALLAD
094	JAZZ COMBO
095	RAGTIME
096	PIANO ROCK & ROLL
097	ARPEGGIO
098	PIANO MARCH
099	STRIDE PIANO
100	WALTZ 2

Song List/Lista de canciones

No./Nº	Title/Título
WORLD	
01	TWINKLE TWINKLE LITTLE STAR
02	ON TOP OF OLD SMOKEY
03	WHEN THE SAINTS GO MARCHING IN
04	AMAZING GRACE
05	COME BIRDS
06	DID YOU EVER SEE A LASSIE?
07	DANNY BOY
08	MY BONNIE
09	HOME SWEET HOME
10	AURA LEE
11	ALOHA OE
12	FURUSATO
13	GREENSLEEVES
14	LONDON BRIDGE
15	UNDER THE SPREADING CHESTNUT TREE
16	SIPPIN' CIDER THROUGH A STRAW
17	GRANDFATHER'S CLOCK
18	ANNIE LAURIE
19	BEAUTIFUL DREAMER
20	MY DARLING CLEMENTINE
21	LITTLE BROWN JUG
22	YANKEE DOODLE
23	I'VE BEEN WORKING ON THE RAILROAD
24	OHI SUSANNA
25	TURKEY IN THE STRAW
EVENT	
26	SILENT NIGHT
27	WE WISH YOU A MERRY CHRISTMAS
28	JINGLE BELLS
29	JOY TO THE WORLD
30	O CHRISTMAS TREE
PIANO/CLASSICS	
31	MARY HAD A LITTLE LAMB
32	LE CYGNE FROM "LE CARNAVAL DES ANIMAUX"
33	AIR FROM "SUITE no.3"
34	SPRING FROM "THE FOUR SEASONS"
35	HUNGARIAN DANCES no.5
36	MINUET IN G MAJOR
37	GAVOTTE (GOSSEC)
38	ARABESQUE (BURGMÜLLER)
39	DECK THE HALL
40	ODE TO JOY
41	AVE MARIA (GOUNOD)
42	PRELUDE op.28 no.7 (CHOPIN)
43	GOING HOME FROM "FROM THE NEW WORLD"
44	FUR ELISE
45	TURKISH MARCH (MOZART)
46	SONATA op.27 no.2 "MOONLIGHT" 1st Mov.
47	ETUDE op.10 no.3 "CHANSON DE L'ADIEU"
48	THE ENTERTAINER
49	FROHLICHER LANDMANN
50	LA CHEVALERESQUE
51	VALSE op.64 no.1 "PETIT CHIEN"
52	LIEBESTRÄUME no.3
53	JESUS BLEIBET MEINE FREUDE
54	CANON (PACHELBEL)
55	MARCH FROM "THE NUTCRACKER"
56	CHANSON DU TOREADOR FROM "CARMEN"
57	INVENTIONEN no.1
58	PRAELUDIUM no.1 (J.S.BACH)
59	TRÄUMEREI
60	NOCTURNE op.9 no.2 (CHOPIN)
61-90	USER SONGS

Dance Music Mode List/
Lista de modos de música de
danza

No./Nº	Title/Título
EDM	
01	ELECTRO DANCE 1
02	ELECTRO DANCE 2
03	ELECTRO DANCE 3
04	BIG BEAT TECHNO 1
05	BIG BEAT TECHNO 2
06	SPEED SHUFFLE 1
07	SPEED SHUFFLE 2
08	POP TRANCE 1
09	POP TRANCE 2
10	SLOW SOUL 1
11	DIGITAL SHUFFLE 1
12	DIGITAL SHUFFLE 2
13	POWER POP 1
14	POWER POP 2
15	POWER POP 3
16	NEO TRANCE 1
17	NEO TRANCE 2
18	HARD SHUFFLE 1
19	HARD SHUFFLE 2
20	ELECTRO BOUNCE 1
21	ELECTRO BOUNCE 2
22	POWER ELECTRO 1
23	POWER ELECTRO 2
24	ACID DANCE
25	POWER DANCE 1
26	POWER DANCE 2
27	FUTURE DANCE
28	DANCE RAGGA
29	ACID ELECTRO 1
30	ACID ELECTRO 2
31	HARD ELECTRO
32	ACID TECHNO 1
33	ACID TECHNO 2
34	FANTASTIC DANCE
35	FUTURE POP
HOUSE	
36	ELECTRIC POP
37	DIGITAL SHUFFLE 3
38	POP DANCE 1
39	POP DANCE 2
40	FUTURE HOUSE 1
41	FUTURE HOUSE 2
42	SPEED HOUSE 1
43	SPEED HOUSE 2
44	URBAN DANCE 1
45	URBAN DANCE 2
HIP-HOP	
46	DEEP SOUL 1
47	DEEP SOUL 2
48	SLOW SOUL 2
49	ELECTRO BOUNCE 3
50	ELECTRO RAGGA

Fingering Guide/ Guía de digitación

Fingered 1, Fingered 2 Chords/ Acordes Fingered 1, Fingered 2

C	
Cm	
Cdim	
Caug *3	
Csus4 *3	
Csus2 *3	
C7	
Cm7 *3	
CM7	
Cm7^b5 *3	
C7^b5 *3	
C7sus4	
Cadd9	
Cmadd9	
CmM7	
Cdim7 *3	
C69 *3	
C6 *1 *3	
Cm6 *2 *3	

- *1 With Fingered 2, interpreted as Am7.
- *2 With Fingered 2, interpreted as Am7^b5.
- *3 Inverted form not supported in some cases.

- *1 Con Fingered 2, se interpreta como Am7.
- *2 Con Fingered 2, se interpreta como Am7^b5.
- *3 En algunos casos no se puede usar la forma invertida.

Fingered 3, Full Range Chords/ Acordes Fingered 3, Full Range

In addition to the chords that can be fingered with Fingered 1 and Fingered 2, the following chords also are recognized.

Además de los acordes que se pueden digitar con Fingered 1 y Fingered 2, también se pueden reconocer los siguientes acordes.

$\frac{C\#}{C}$	$\frac{D}{C}$	$\frac{E}{C}$	$\frac{F}{C}$	$\frac{G}{C}$	$\frac{A^b}{C}$	$\frac{B^b}{C}$	$\frac{B}{C}$	$\frac{C\#m}{C}$	$\frac{Dm}{C}$	$\frac{Fm}{C}$
$\frac{Gm}{C}$	$\frac{Am}{C}$	$\frac{B^bm}{C}$	$\frac{Ddim}{C}$	$\frac{A^b7}{C}$	$\frac{F7}{C}$	$\frac{Fm7}{C}$	$\frac{Gm7}{C}$	$\frac{A^badd9}{C}$		

NOTE

- With Fingered 3, the lowest note fingered is interpreted as the base note. Inverted forms are not supported.
- With Full Range Chord, when the lowest note fingered is a certain distance from the neighboring note, the chord is interpreted as a fraction chord.
- Unlike Fingered 1, 2, and 3, Full Range Chord requires pressing of at least three keys to form a chord.

NOTA

- Con Fingered 3, la nota más baja digitada se interpreta como nota base. No se pueden usar formas invertidas.
- Con Full Range Chord, cuando la nota digitada más baja se encuentre a cierta distancia de la nota adyacente, el acorde se interpreta como un acorde bitonal.
- A diferencia de Fingered 1, 2, y 3, Full Range Chord requiere la pulsación de tres teclas como mínimo para formar un acorde.

Chord Example List/Lista de ejemplos de acordes

Root Chord Type	C	C ² /(D ⁺)	D	(D ⁺)/E ⁺	E	F	F [#] /(G ⁺)	G	(G ⁺)/A ⁺	A	(A ⁺)/B ⁺	B
M												
m												
dim												
aug												
sus4												
sus2												
7												
m7												
M7												
m7 ^b 5												
7 ^b 5												
7sus4												
add9												
madd9												
mM7												
dim7												
69												
6												
m6												

- Since the chord input range is limited, this model may not support some of the chords shown above.
- Debido a que el rango de entrada de acordes es limitado, es posible que este modelo no admita algunos de los acordes mostrados arriba.



This recycle mark indicates that the packaging conforms to the environmental protection legislation in Germany.

Esta marca de reciclaje indica que el empaquetado se ajusta a la legislación de protección ambiental en Alemania.

CASIO®

 MA1607-A Printed in China



CTK2500-ES-1A

CASIO COMPUTER CO., LTD.
6-2, Hon-machi 1-chome
Shibuya-ku, Tokyo 151-8543, Japan

© 2016 CASIO COMPUTER CO., LTD.

Free Manuals Download Website

<http://myh66.com>

<http://usermanuals.us>

<http://www.somanuals.com>

<http://www.4manuals.cc>

<http://www.manual-lib.com>

<http://www.404manual.com>

<http://www.luxmanual.com>

<http://aubethermostatmanual.com>

Golf course search by state

<http://golfingnear.com>

Email search by domain

<http://emailbydomain.com>

Auto manuals search

<http://auto.somanuals.com>

TV manuals search

<http://tv.somanuals.com>