

MARCH 2019



Quad Camera



Precision 60



SpeakerTrack 60



PTZ-12

# Camera guide

for Cisco Quad Camera, Cisco TelePresence Precision 60, Cisco TelePresence SpeakerTrack 60, and PTZ-12

## Thank you for choosing Cisco!

Your Cisco product has been designed to give you many years of safe, reliable operation.

This guide describes the Quad Camera, Precision 60, SpeakerTrack 60, and PTZ-12 Camera.

May we recommend you to visit the Cisco website regularly for updated versions of the user documentation.

The user documentation can be found at:

- ▶ <https://www.cisco.com/go/telepresence/docs>
- ▶ <https://www.cisco.com/go/room-docs>

## How to use this guide

The top menu bar and the entries in the Table of Contents are all hyperlinks. You can click on them to go to the topic.

## Table of Contents

<b>Introduction .....</b>	<b>3</b>	Connecting multiple cameras to the Codec Pro .....	25
User documentation and software .....	4	Main camera .....	25
Products covered in this guide .....	4	Using the HD-BNC connector .....	25
User documentation .....	4	Adding multiple cameras .....	25
Software .....	4	Connecting multiple cameras to the SX80 codec.....	26
<b>Physical interface .....</b>	<b>5</b>	Main camera .....	26
Quad Camera .....	6	Using the analog video or DVI-I inputs .....	26
Precision 60 Camera .....	7	Adding multiple cameras .....	26
SpeakerTrack 60 Camera .....	8	<b>Factory reset .....</b>	<b>27</b>
PTZ-12 Camera .....	9	Quad Camera .....	28
<b>Connecting to a codec .....</b>	<b>10</b>	Precision 60 Camera .....	29
Codec compatibility .....	11	SpeakerTrack 60 Camera .....	30
Software compatibility .....	12	Factory resetting the device .....	30
CE software .....	12	Factory resetting the cameras.....	31
RoomOS software .....	12	<b>Appendix .....</b>	<b>32</b>
Connect Quad Camera to Codec Pro .....	13	Technical specifications.....	33
Connect Quad Camera to Codec Plus .....	14	Quad Camera.....	33
Connect Quad Camera to SX80 Codec .....	15	Precision 60 Camera .....	34
Connect Precision 60 to Codec Pro.....	16	SpeakerTrack 60 Camera .....	35
Connect Precision 60 to Codec Plus .....	17	PTZ-12 Camera.....	36
Connect Precision 60 to SX80 Codec .....	18	Contact us .....	37
Connect SpeakerTrack 60 to Codec Pro.....	19		
Connect SpeakerTrack 60 to SX80 Codec .....	20		
Connect SpeakerTrack 60 to Codec C40 .....	21		
Connect SpeakerTrack 60 to Codec C60 .....	22		
Connect SpeakerTrack 60 to Codec C90 .....	23		
Connect PTZ-12 to Codec Plus.....	24		

CHAPTER 1

# *Introduction*

## User documentation and software

### Products covered in this guide

- Cisco Quad Camera
- Cisco TelePresence Precision 60 Camera
- Cisco TelePresence SpeakerTrack 60 Camera
- Cisco PTZ-12 Camera

### User documentation

This guide provides you with information required to install the cameras on the video system.

The video system can be registered to an on-premise service (CUCM, VCS) or registered to our cloud service (Cisco Webex).

### Documentation on the Cisco web site

Visit the Cisco web site regularly for updated versions of the guides:

▶ <https://www.cisco.com/go/telepresence/docs>

▶ <https://www.cisco.com/go/room-docs>

Explore the Cisco Project Workplace to find inspiration and guidelines when preparing your office or meeting room for video conferencing:

▶ <https://www.cisco.com/go/projectworkplace>

### Software

The camera software is automatically upgraded through the codec for the Precision 60, SpeakerTrack 60 and Quad Camera. For the PTZ-12 camera no software upgrade applies.

For more information, see the ▶ [Software compatibility](#) chapter.

Download software for the video system from the Cisco web site: ▶ <https://software.cisco.com/download/home>

We recommend reading the Software release notes (CE9):  
▶ [Cisco Collaboration Endpoint Software 9](#)

## CHAPTER 2

# *Physical interface*

## Quad Camera

### Video

- HDMI 1 is the main video source. The maximum resolution is 1080p60.
- For long cable lengths, HDMI extenders supporting EDID should be used. The extender must not alter the SPA address or any EDID information incorrectly. The extender must support ARC (Audio Return Channel) when used with the Codec Plus or Codec Pro.
- If EDID is not supported, use the following setting:

*Cameras > Camera n > AssignedSerialNumber*

This setting allows you to manually assign a camera ID to a camera by associating the camera ID with the camera's serial number. The setting is persistent until the codec is factory reset.

### Power

- Power rating: 12 V<sub>DC</sub>, 5.83 A.
- Always use the provided cables and power adapter.

### Ethernet

For camera control and software upgrades.



Use Ethernet cable only. Do not connect a serial VISCA cable to the Ethernet port on the Precision 60 camera, as this will cause severe damage to the camera.

### Kensington lock

The Kensington lock may be used to prevent the camera from being moved from its place or to prevent theft.

For more information about the Quad Camera setup, refer to the following installation guides:

- ▶ [Cisco Webex Room Kit Pro installation guide](#)
- ▶ [Cisco Webex Room Kit Plus installation guide](#)
- ▶ [Cisco TelePresence SX80 Integrator Package with Quad Camera installation guide](#)

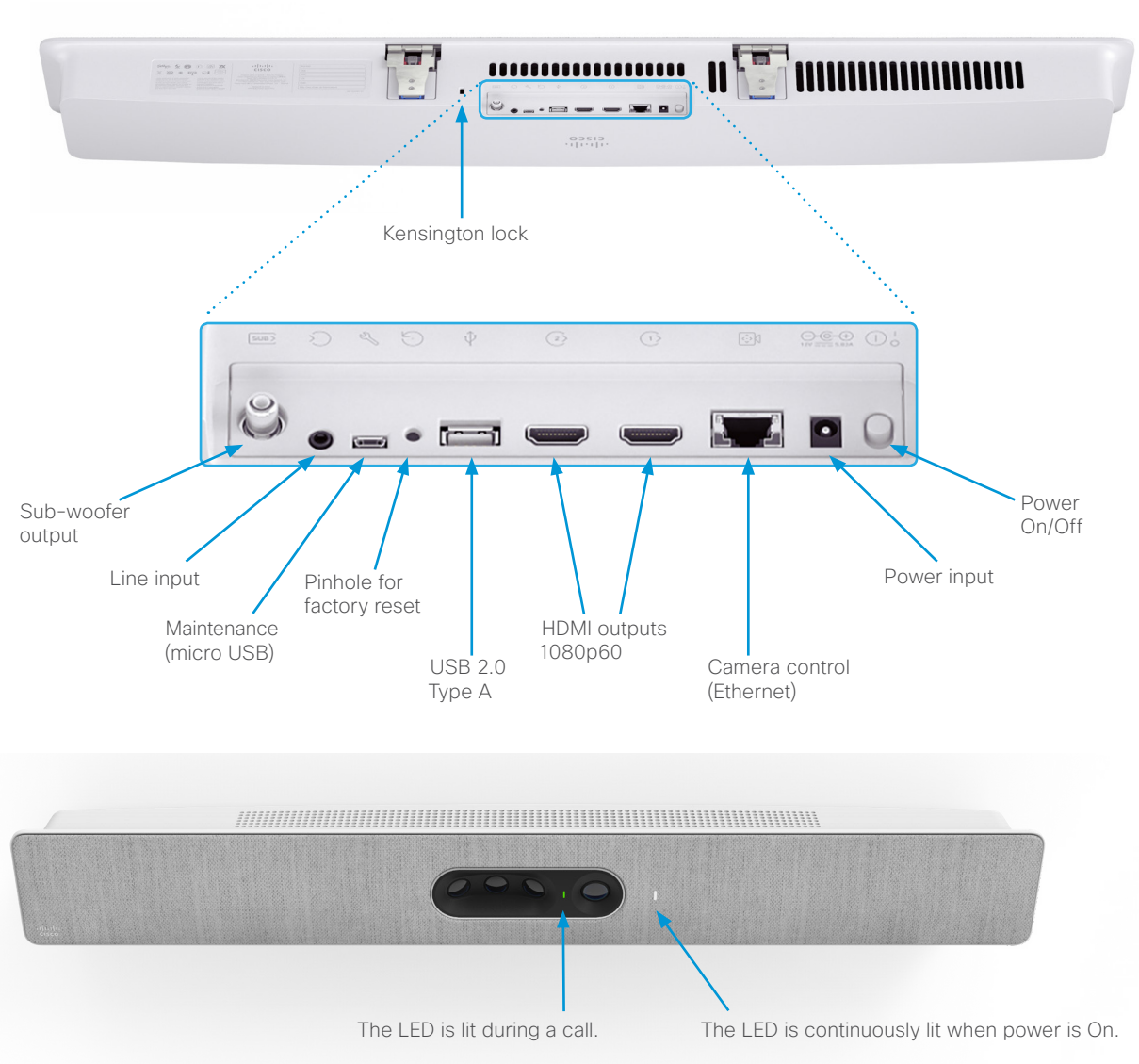

## Precision 60 Camera

### Video

- HDMI is the main video source. The maximum resolution is 1080p60.
- 3G-SDI is the secondary video source. The maximum resolution is 1080p60.
- For long cable lengths, HDMI extenders supporting EDID should be used. The extender must not alter the SPA address or any EDID information incorrectly.
- If EDID is not supported, use the following setting:

*Cameras > Camera n > AssignedSerialNumber*

This setting allows you to manually assign a camera ID to a camera by associating the camera ID with the camera's serial number. The setting is persistent until the codec is factory reset.

### Power

- Power rating: 12 V<sub>DC</sub>, 3 A.
- Always use the provided cables and power adapter.

### Ethernet

For camera control and software upgrades.

 Use Ethernet cable only. Do not connect a serial VISCA cable to the Ethernet port on the Precision 60 camera, as this will cause severe damage to the camera.

### Kensington lock

The Kensington lock may be used to prevent the camera from being moved from its place or to prevent theft.

For more information about the Precision 60 setup, refer to the following installation guides:

- ▶ [Cisco Webex Room Kit Plus Precision 60 Installation Guide](#)
- ▶ [Cisco Webex Room Kit Pro Precision 60 Installation Guide](#)
- ▶ [Cisco TelePresence SX80 Installation Guide](#)

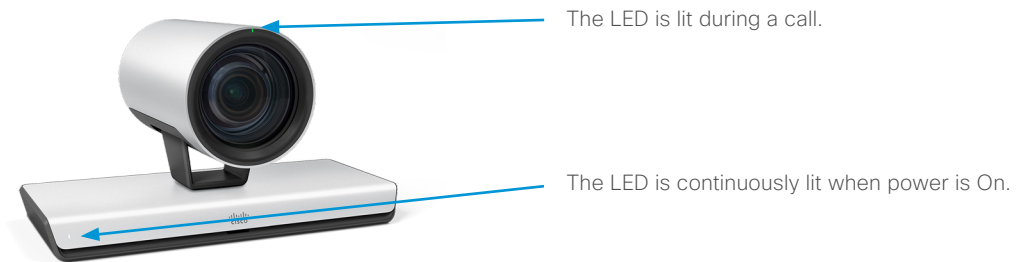
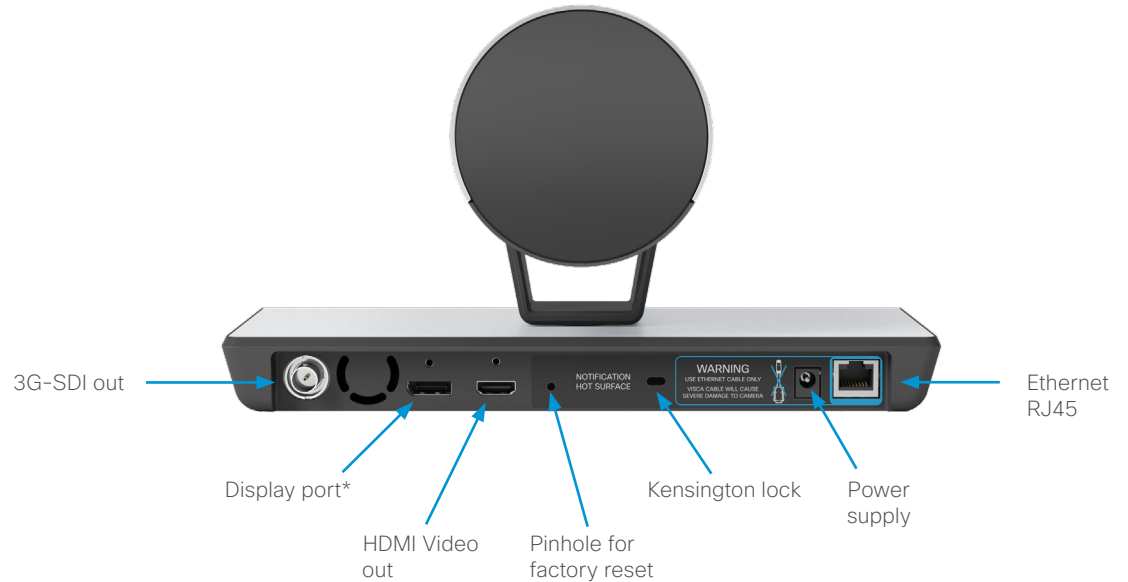

\* For future use

## SpeakerTrack 60 Camera

### Video

- Two HDMI cables from the cameras.

### Power

- Power rating: 12 V<sub>DC</sub>, 6.5 A.
- Always use the provided cables and power adapter.
- Power out to cameras (internal connection).

### Ethernet

Two Ethernet ports are used for the internal camera control connection. The third connector is used for connecting the codec.

 Use Ethernet cable only. Do not connect a serial VISCA cable to the Ethernet port on the SpeakerTrack 60 camera, as this will cause severe damage to the camera.

### Microphone connectors

The right set is used for internal connection to the microphone panel. The left set of connectors is intended for future use.

### Kensington lock

The Kensington lock may be used to prevent the camera from being moved from its place or to prevent theft.

For more information about the SpeakerTrack 60 setup, refer to the following installation guides:

- ▶ [Cisco TelePresence SpeakerTrack 60 installation guide](#)
- ▶ [Cisco Webex Codec Pro installation guide](#)
- ▶ [Cisco TelePresence SX80 Installation Guide](#)

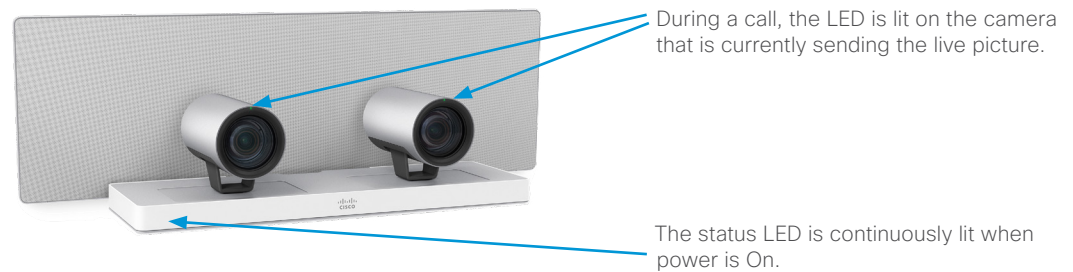
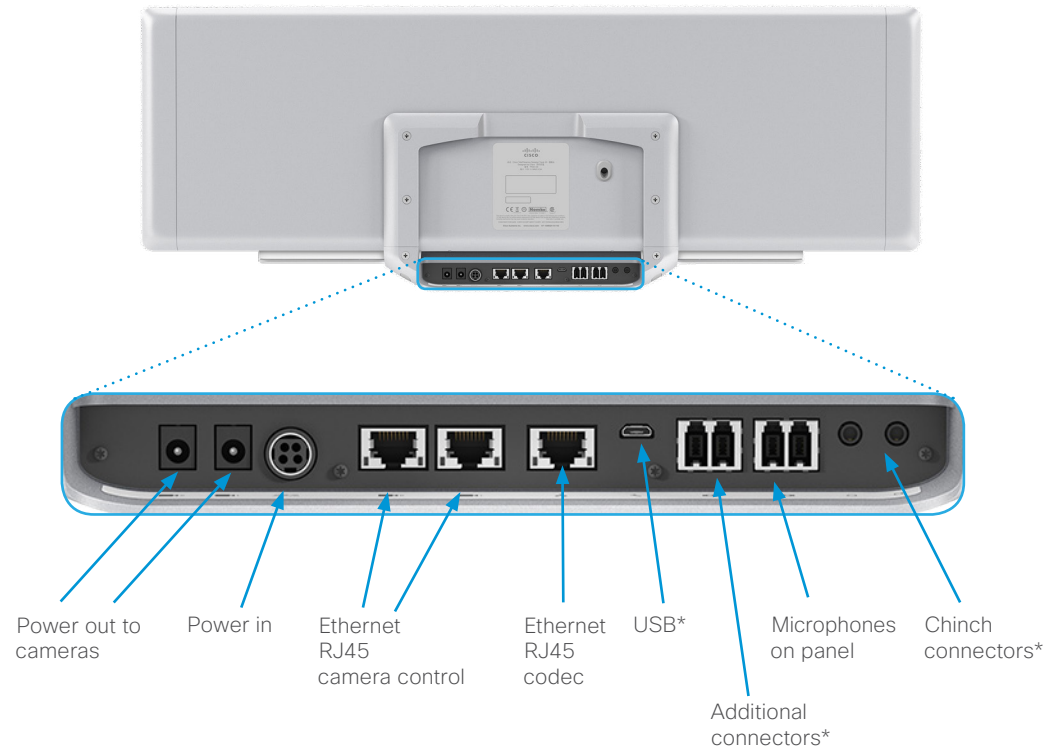

\* For future use



## PTZ-12 Camera

### Video

- HDMI is the main video source. The maximum resolution is 1080p60.

### Power

- Power rating: 12 V<sub>DC</sub>, 1.4 A.
- Always use the provided cables and power adapter (12V<sub>DC</sub>, JEITA type4). Do **NOT** use any other AC power adaptor.

### Ethernet

For camera control.

### Factory reset

A factory reset should only be performed by a system administrator or in contact with Cisco technical support.

For more information about the PTZ-12 setup, refer to the [Cisco Webex Room Kit Plus PTZ-12 installation guide](#)

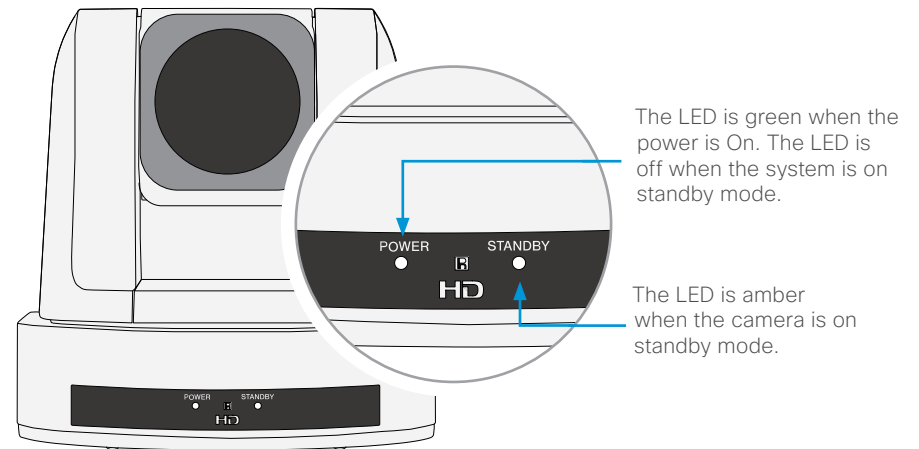
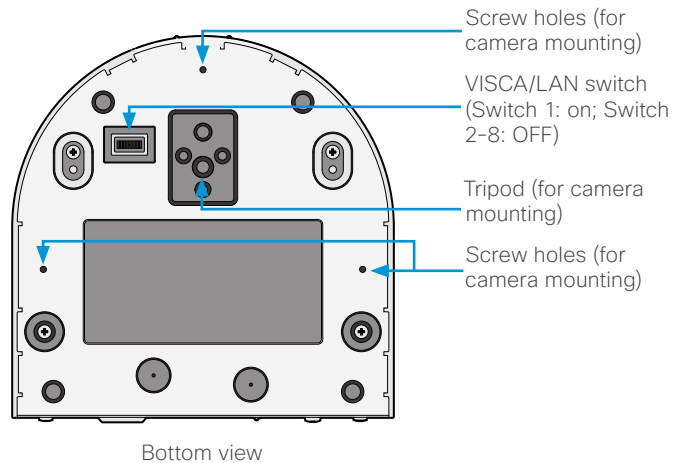
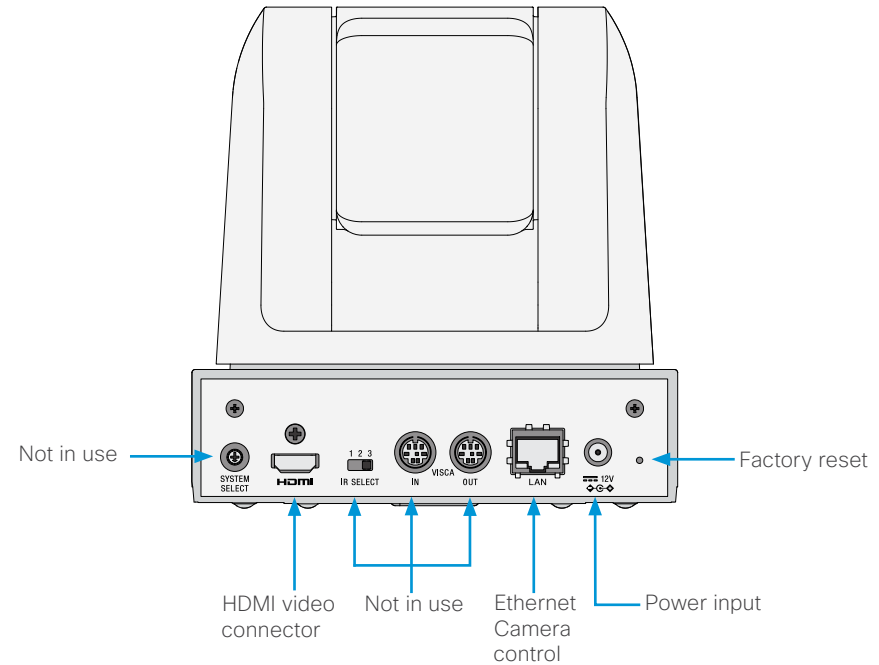

## CHAPTER 3

# *Connecting to a codec*

## Codec compatibility

### Quad Camera

The Quad Camera is compatible with the following codecs:

- Cisco Webex Codec Pro
- Cisco Webex Codec Plus
- Cisco TelePresence SX80 codec

### Precision 60

The Precision 60 camera is compatible with the following codecs:

- Cisco Webex Codec Pro
- Cisco Webex Codec Plus
- Cisco TelePresence SX80 codec

### SpeakerTrack 60

The SpeakerTrack 60 system is compatible with the following codecs:

- Cisco Webex Codec Pro
- Cisco TelePresence SX80 codec
- Cisco TelePresence C90 codec
- Cisco TelePresence C60 codec
- Cisco TelePresence C40 codec

### PTZ-12

The PTZ-12 Camera is compatible with the following codec:

- Cisco Webex Codec Plus



Cisco Webex Codec Pro



Cisco Webex Codec Plus



Cisco TelePresence Codec SX80



Cisco TelePresence Codec C40/C60



Cisco TelePresence Codec C90

## Software compatibility

### CE software

The camera software for the Quad Camera, Precision 60 and SpeakerTrack 60 cameras is automatically upgraded through the codec.

For the PTZ-12 camera no software upgrade applies.

Minimum CE software version requirement for the codecs can be found in the table below:

	Codec C90	Codec C40/C60	Codec SX80	Codec Plus	Codec Pro
Quad Camera	N/A	N/A	CE 9.2	CE 9.1	CE 9.4
Precision 60	N/A	N/A	TC 7.1, CE 8.1	CE 9.1	CE 9.4
SpeakerTrack 60	TC 7.1	TC 7.1	TC 7.1, CE 8.1	N/A	CE 9.4
PTZ-12	N/A	N/A	N/A	CE 9.6	N/A

### RoomOS software

The camera software for the Quad Camera, Precision 60 and SpeakerTrack 60 cameras is automatically upgraded through the codec when a new version is available from the cloud service.

For the PTZ-12 camera no software upgrade applies.

## Connect Quad Camera to Codec Pro

- Connect the video cable (HDMI) between the camera and codec.  
 Codec: Always use Connector 1 (HDMI input) for the main camera.  
 Camera: Connect to connector 1 (HDMI output).
- Connect the camera control cable (Ethernet) between the camera control ports on the camera and codec. The connectors are marked with the camera control symbol.
- Connect the power adapter to the camera and connect to power.
- Connect other codec cables as described in the [Cisco Webex Room Kit Pro installation guide](#).

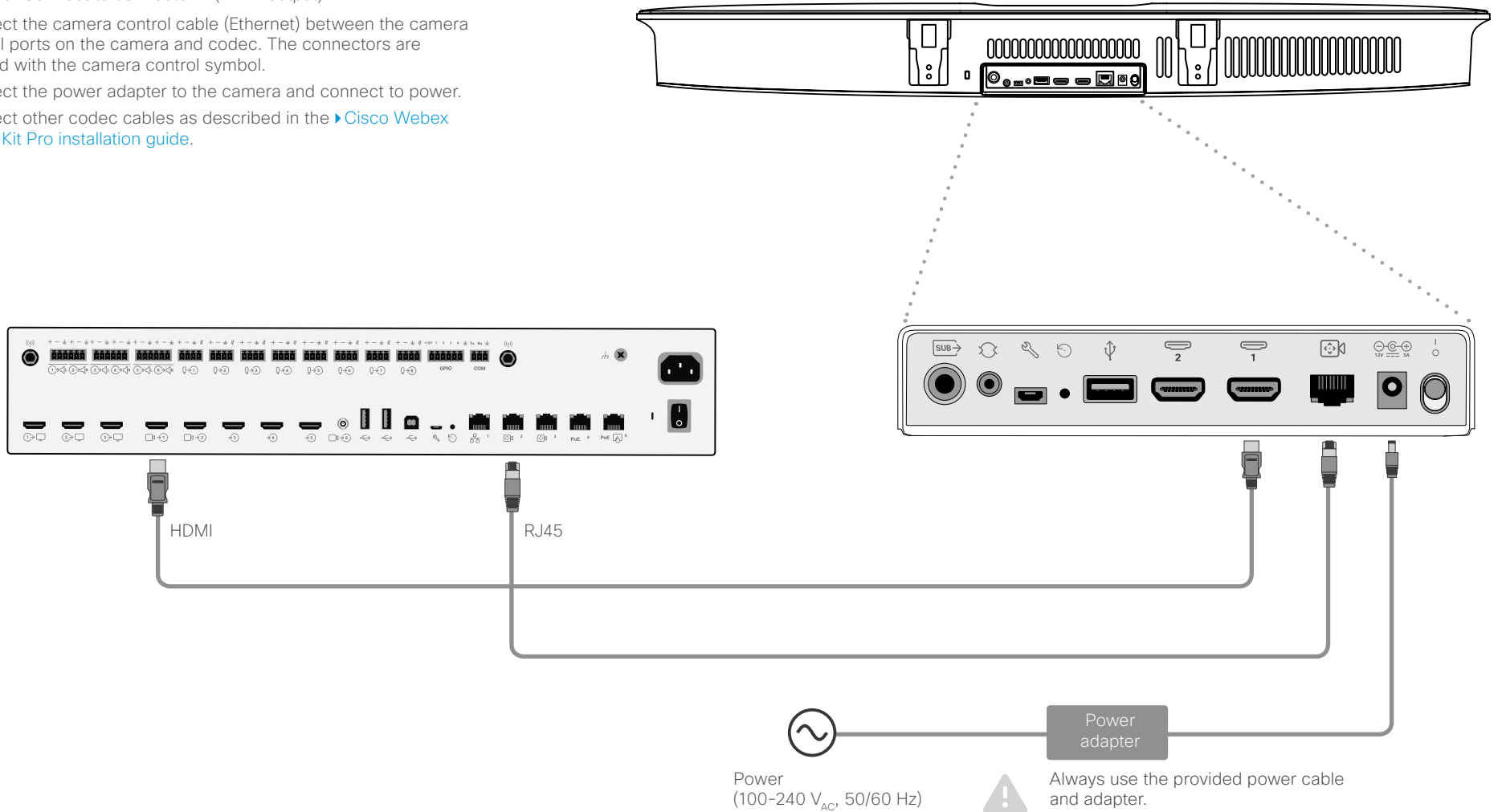

## Connect Quad Camera to Codec Plus

- Connect the video cable (HDMI) between the camera and codec.  
Codec: Always use Connector 1 (HDMI input) for the main camera.  
Camera: Connect to connector 1 (HDMI output).
- Connect the camera control cable (Ethernet) between the camera control ports on the camera and codec. The connectors are marked with the camera control symbol.
- Connect the power adapter to the camera and connect to power.
- Connect other codec cables as described in the [Cisco Webex Room Kit Plus installation guide](#).

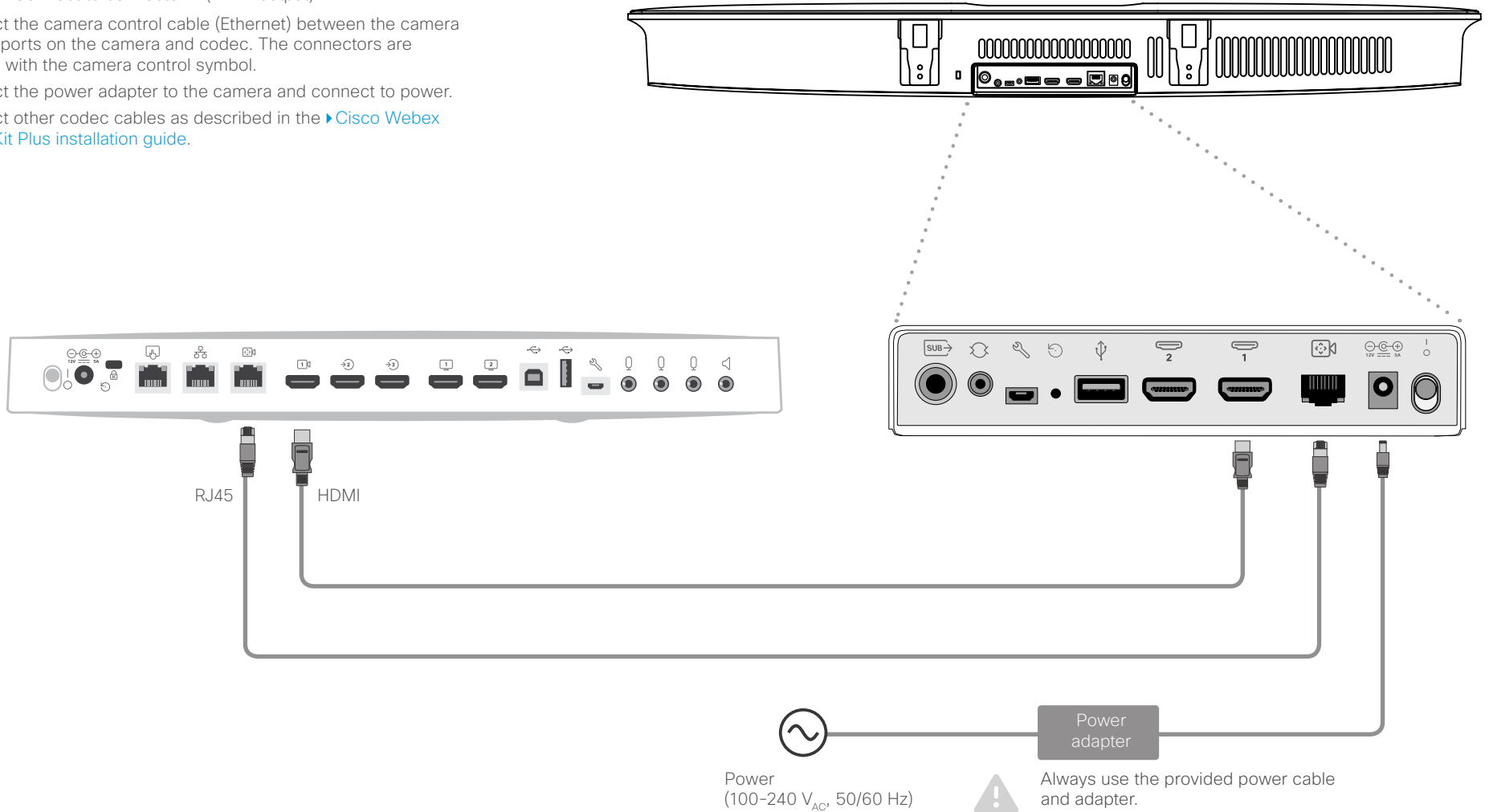

## Connect Quad Camera to SX80 Codec

- Connect the video cable (HDMI) between the camera and codec.
  - Codec: Always use Connector 1 (HDMI input) for the main camera.
  - Camera: Connect to connector 1 (HDMI output).
- Connect the camera control cable (Ethernet) between the camera and codec.
  - Codec: Connect to the codec's 2nd or 3rd Ethernet port.
  - Camera: The connector is marked with the camera control symbol.

Connect a network switch to the codec's 2nd or 3rd Ethernet port if you need more than two ports to support your device.
- Connect the power adapter to the camera and connect to power.
- Connect other codec cables as described in the [Cisco TelePresence SX80 Integrator Package with Quad Camera Installation Guide](#).

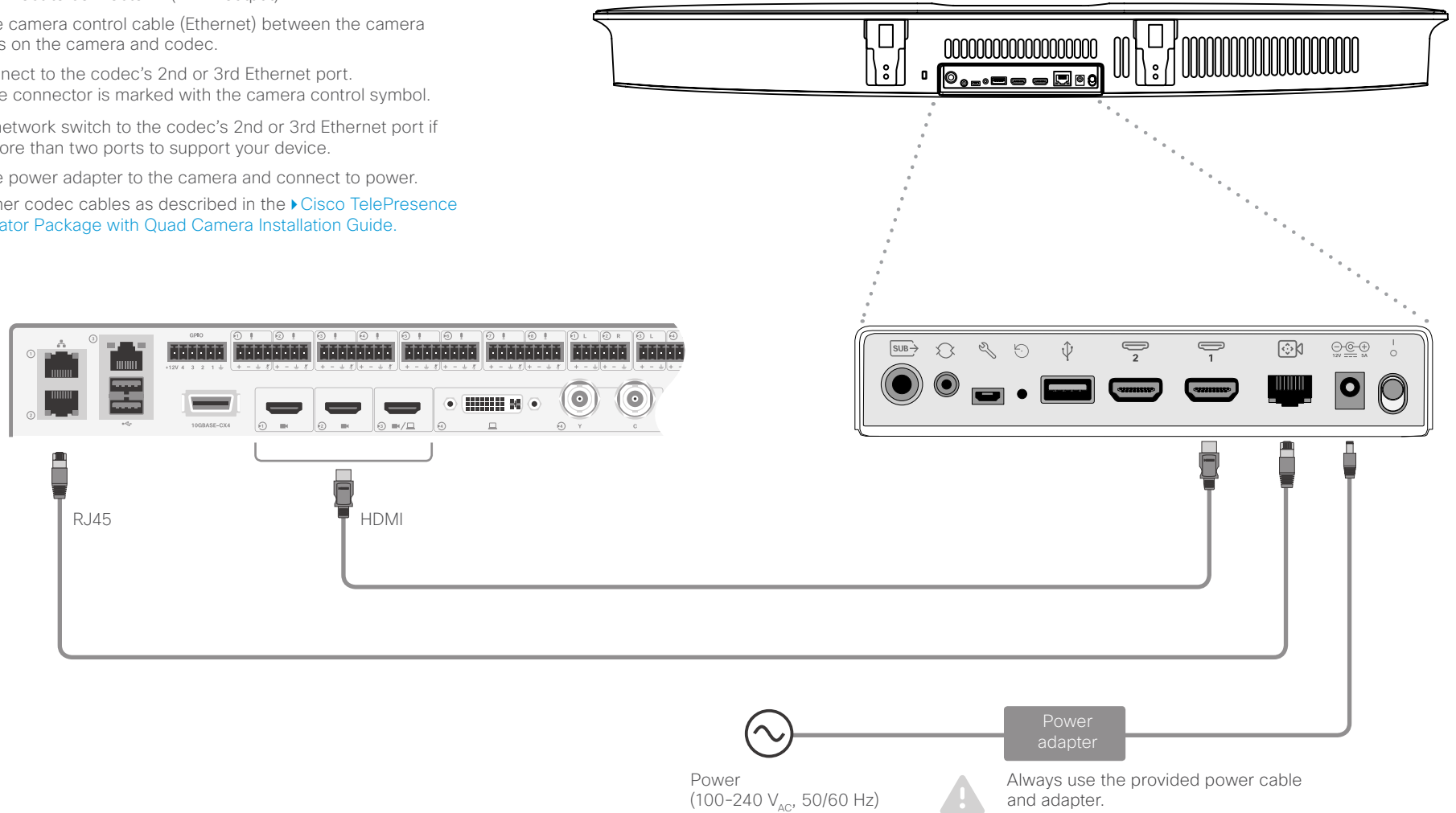

## Connect Precision 60 to Codec Pro

- Connect the video cable (HDMI) between the camera and codec.  
Codec: Always use Connector 1 (HDMI input) for the main camera.  
Camera: Connect to the HDMI output.
- If you use a coaxial cable for video, you will need a BNC to HD-BNC cable or a BNC to HD-BNC adapter to connect the Precision 60 (BNC) to the Codec Pro (HD-BNC).
- Connect the camera control cable (Ethernet) between the camera control ports on the camera and codec.  
Codec: The connector is marked with the camera control symbol.  
Camera: Connect to the Ethernet port.
- Connect the power adapter to the camera and connect to power.
- Connect other codec cables as described in the [Cisco Webex Room Kit Pro Precision 60 installation guide](#).

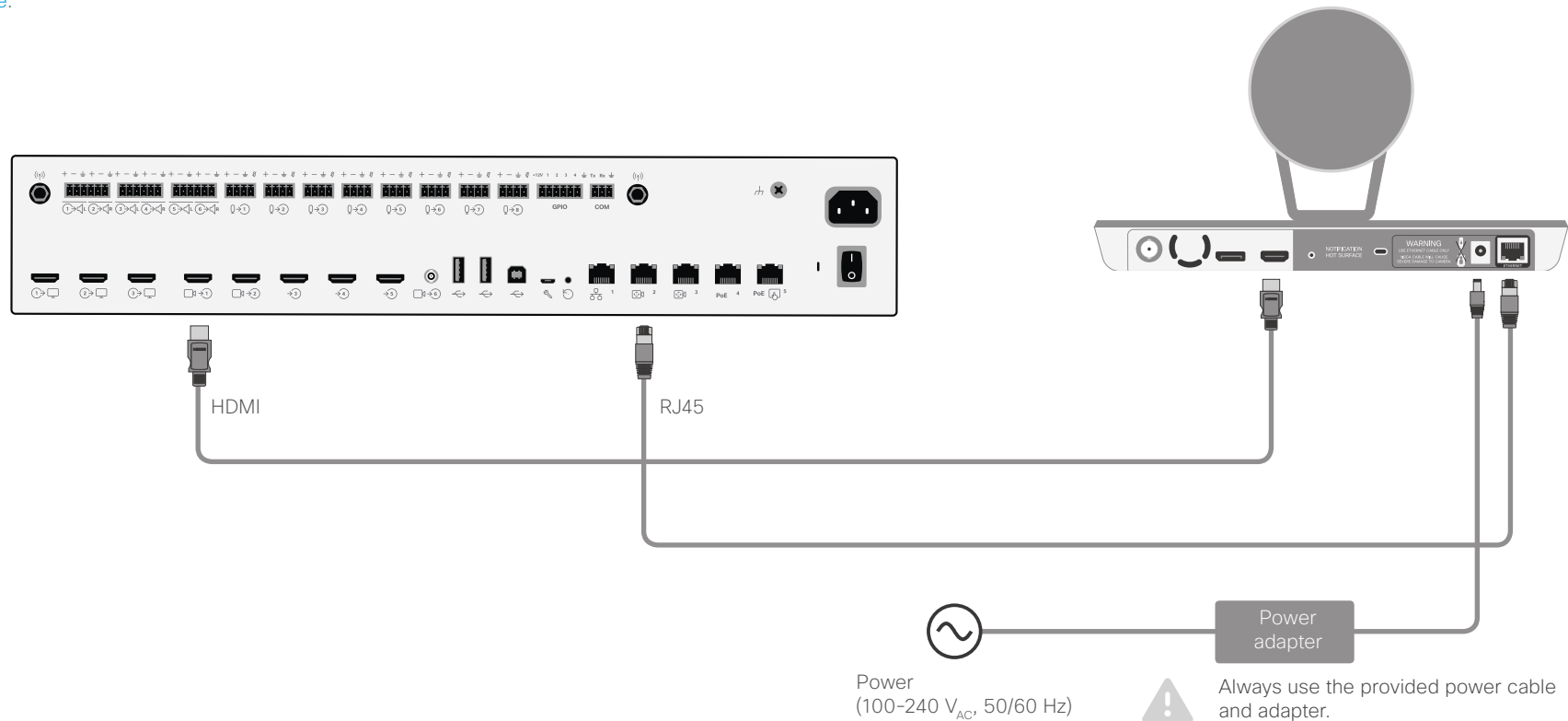



## Connect Precision 60 to Codec Plus

- Connect the video cable (HDMI) between the camera and codec.  
Codec: Always use Connector 1 (HDMI input) for the main camera.  
Camera: Connect to the HDMI output.
- Connect the camera control cable (Ethernet) between the camera control ports on the camera and codec.  
Codec: The connector is marked with the camera control symbol.  
Camera: Connect to the Ethernet port.
- Connect the power adapter to the camera and connect to power.
- Connect other codec cables as described in the [Cisco Webex Room Kit Plus Precision 60 installation guide](#).

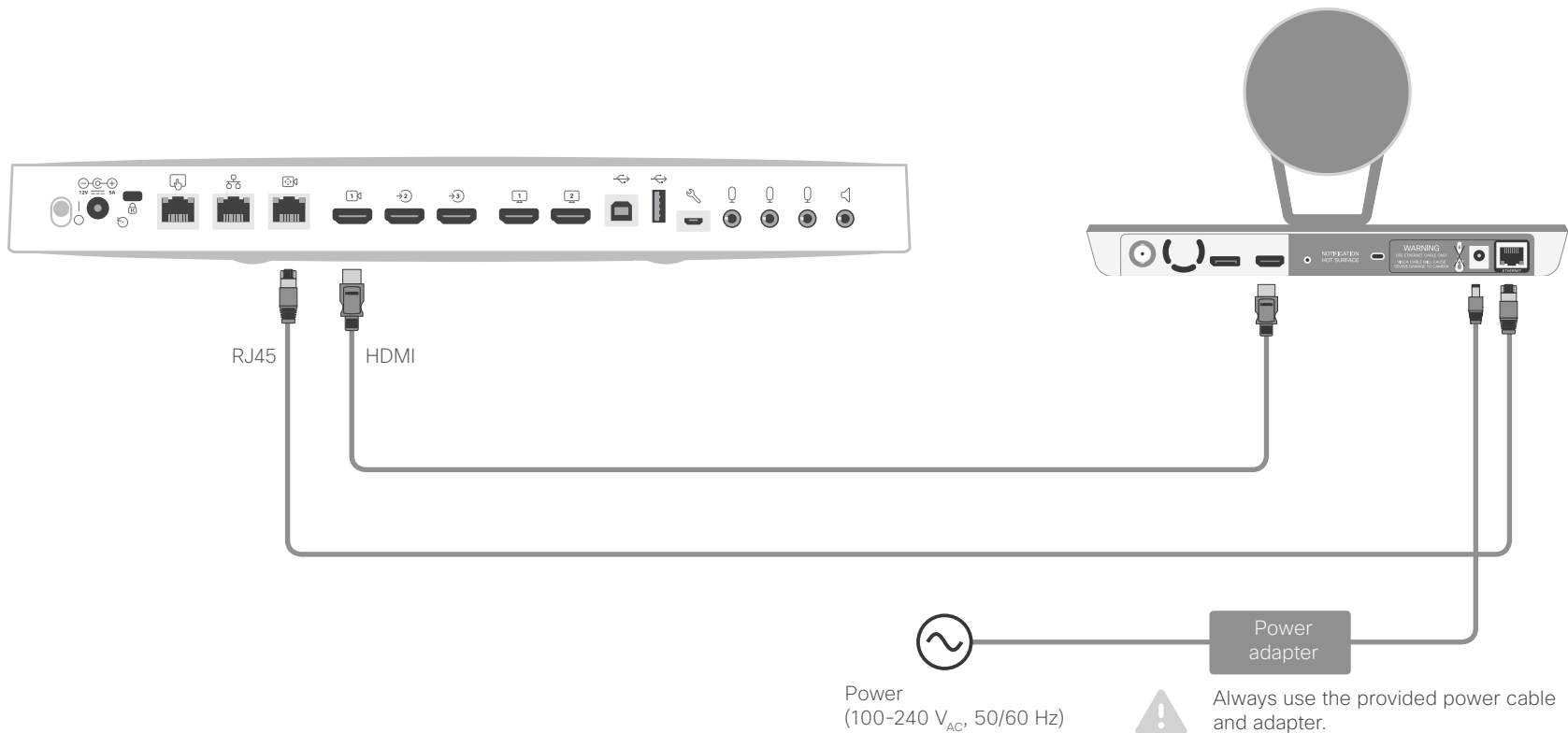

## Connect Precision 60 to SX80 Codec

- Connect the video cable (HDMI) between the camera and codec.  
Codec: Always use Connector 1 (HDMI input) for the main camera.  
Camera: Connect to the HDMI output.
- Connect the camera control cable (Ethernet) between the camera control ports on the camera and codec.  
Codec: The connector is marked with the camera control symbol.  
Camera: Connect to the Ethernet port.
- Connect a network switch to the codec's 2nd or 3rd Ethernet port if you need more than two ports to support your device.
- Connect the power adapter to the camera and connect to power.
- Connect other codec cables as described in the [Cisco Telepresence SX80 installation guide](#).

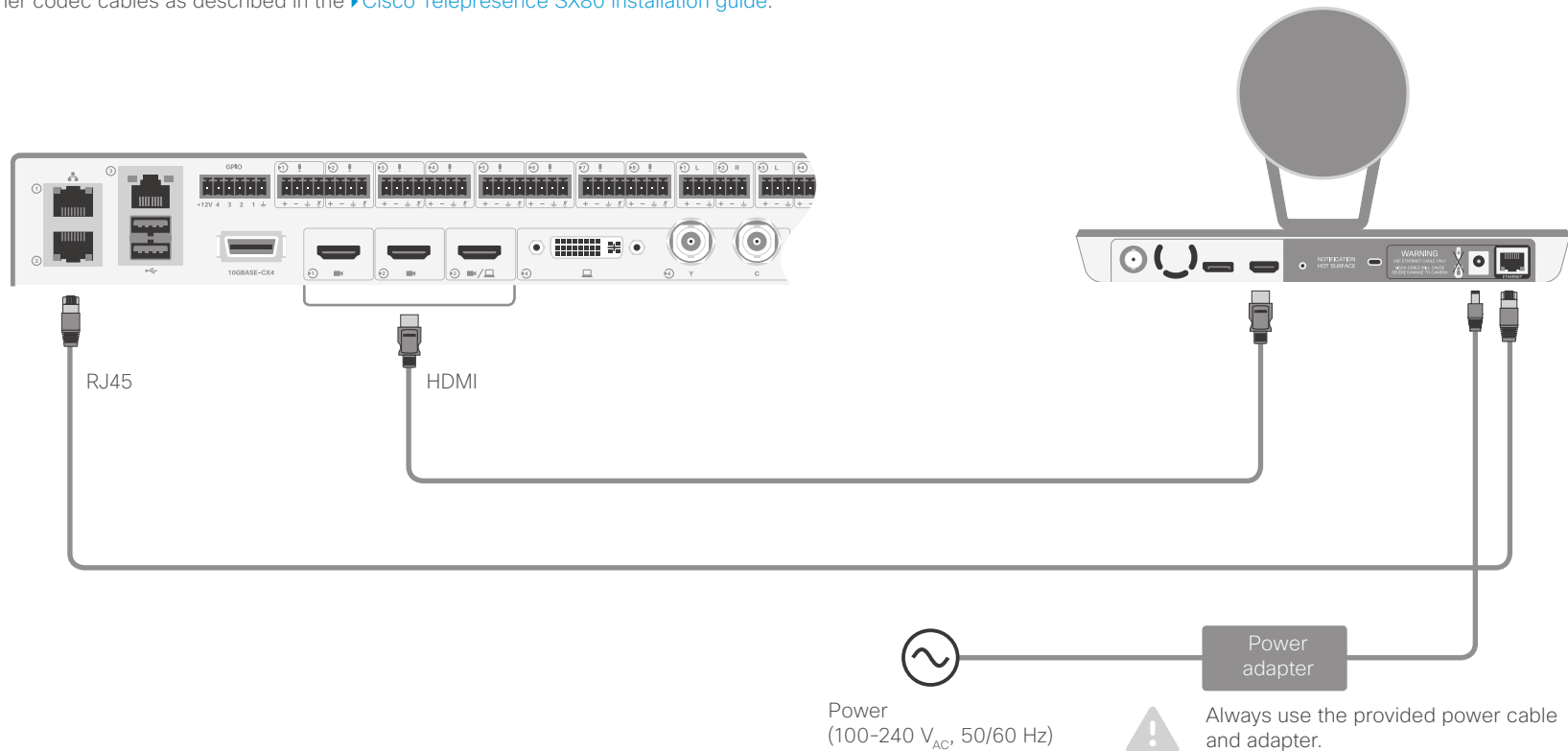

## Connect SpeakerTrack 60 to Codec Pro

- Connect the video cables (HDMI).  
Left camera: Connect between Connector 1 (HDMI input) on the codec to the HDMI input of the left camera.  
Right camera: Connect between Connector 2 (HDMI input) on the codec to the HDMI input of the right camera.
- Connect the camera control cable (Ethernet) between the camera control ports on the camera and codec.  
Codec: The connector is marked with the camera control symbol.  
Camera: Connect to the Ethernet port.
- Connect the power adapter to the SpeakerTrack 60 connector panel and connect to power.
- Connect other codec cables as described in the [Cisco Webex Codec Pro installation guide](#).

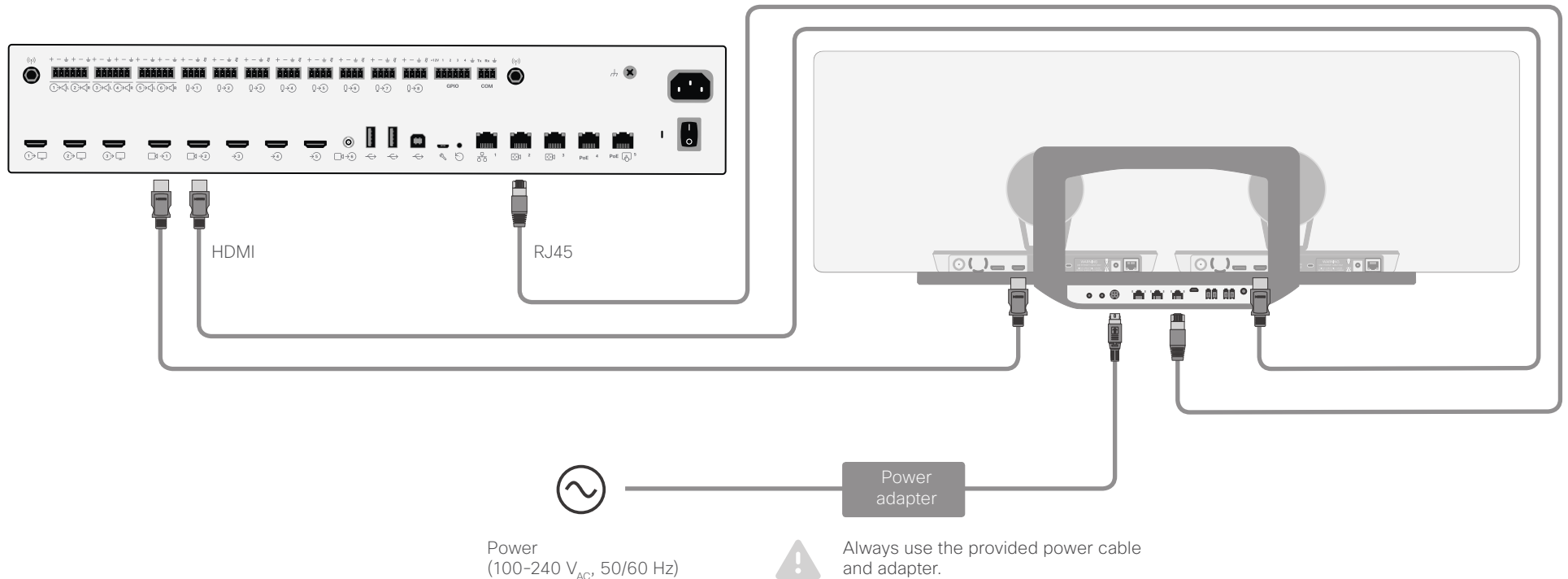

## Connect SpeakerTrack 60 to SX80 Codec

- Connect the video cables (HDMI).  
Left camera: Connect between Connector 1 (HDMI input) on the codec to the HDMI input of the left camera.  
Right camera: Connect between Connector 2 (HDMI input) on the codec to the HDMI input of the right camera.
- Connect the camera control cable (Ethernet). Connect between the codec's 2nd or 3rd Ethernet port to the Network port (Ethernet) on the SpeakerTrack 60 connector panel.
- Connect the power adapter to the SpeakerTrack 60 connector panel and connect to power.
- Connect other codec cables as described in the [Cisco Telepresence SX80 installation guide](#).

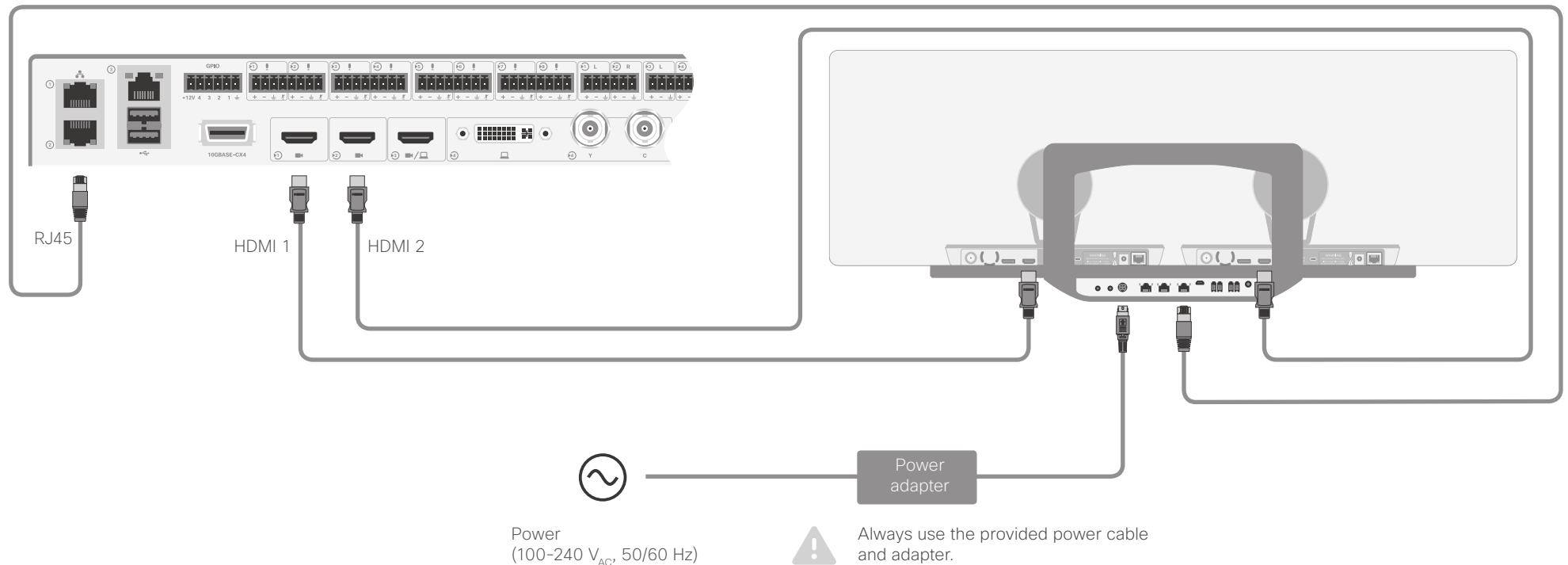

## Connect SpeakerTrack 60 to Codec C40

- Connect the video cables (HDMI).  
Left camera: Connect between Connector 1 (HDMI input) on the codec to the HDMI input of the left camera.  
Right camera: Connect between Connector 2 (HDMI input) on the codec to the HDMI input of the right camera.
- Connect the camera control cable (Ethernet) between the codec's 2nd Ethernet port and the Network port (Ethernet) on the SpeakerTrack 60.
- Connect the power adapter to the SpeakerTrack 60, and connect to power.
- Connect other codec cables as described in the [Cisco TelePresence Coded C40 installation guide](#).

**i** When using a SpeakerTrack 60 with a C Series codec, the codec cannot be controlled with the TRC5 (Cisco Remote Control). Instead, a Cisco TelePresence Touch 8 user interface or an external control device must be used.

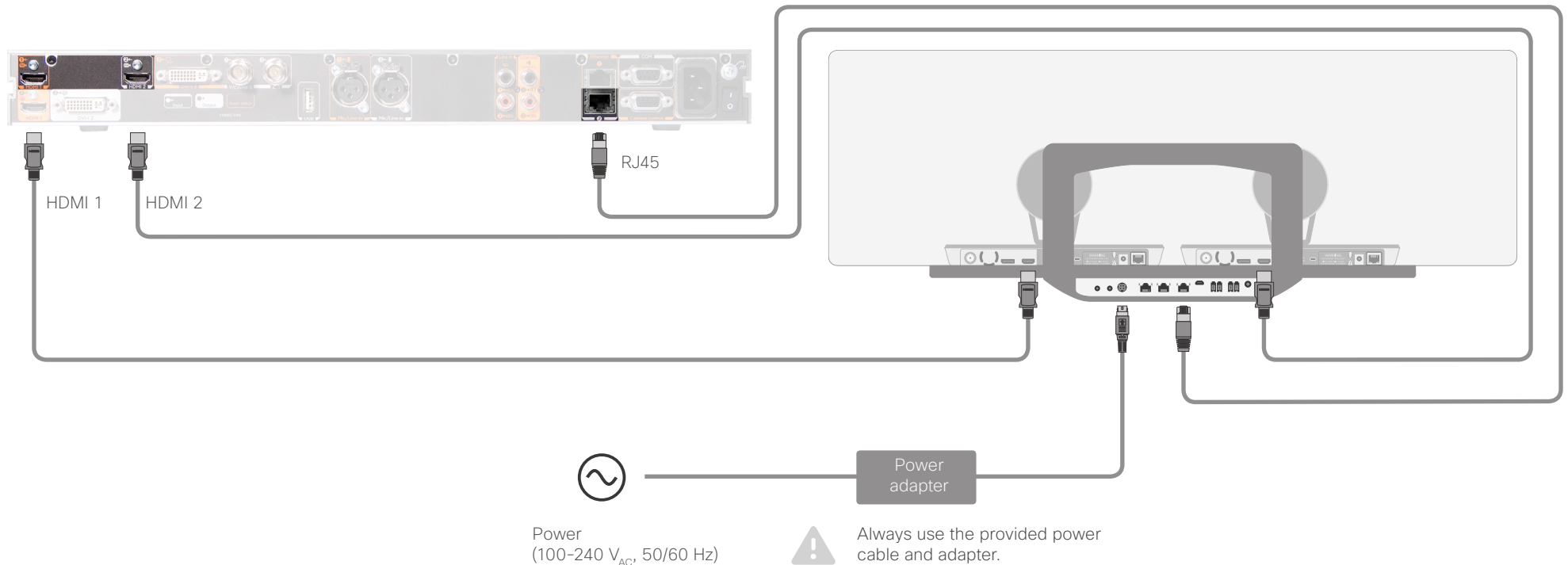

## Connect SpeakerTrack 60 to Codec C60

- Connect the video cables (HDMI).  
Left camera: Connect between Connector 1 (HDMI input) on the codec to the HDMI input of the left camera.  
Right camera: Connect between Connector 2 (HDMI input) on the codec to the HDMI input of the right camera.
- Connect the camera control cable (Ethernet). Connect between the codec's 2nd Ethernet port and the Network port (Ethernet) on the SpeakerTrack 60 connector panel.
- Connect the power adapter to the SpeakerTrack 60 connector panel and connect to power.
- Connect other codec cables as described in the [Cisco TelePresence Codec C60 installation guide](#).

 When using a SpeakerTrack 60 with a C Series codec, the codec cannot be controlled with the TRC5 (Cisco Remote Control). Instead, a Cisco TelePresence Touch 8 user interface or an external control device must be used.

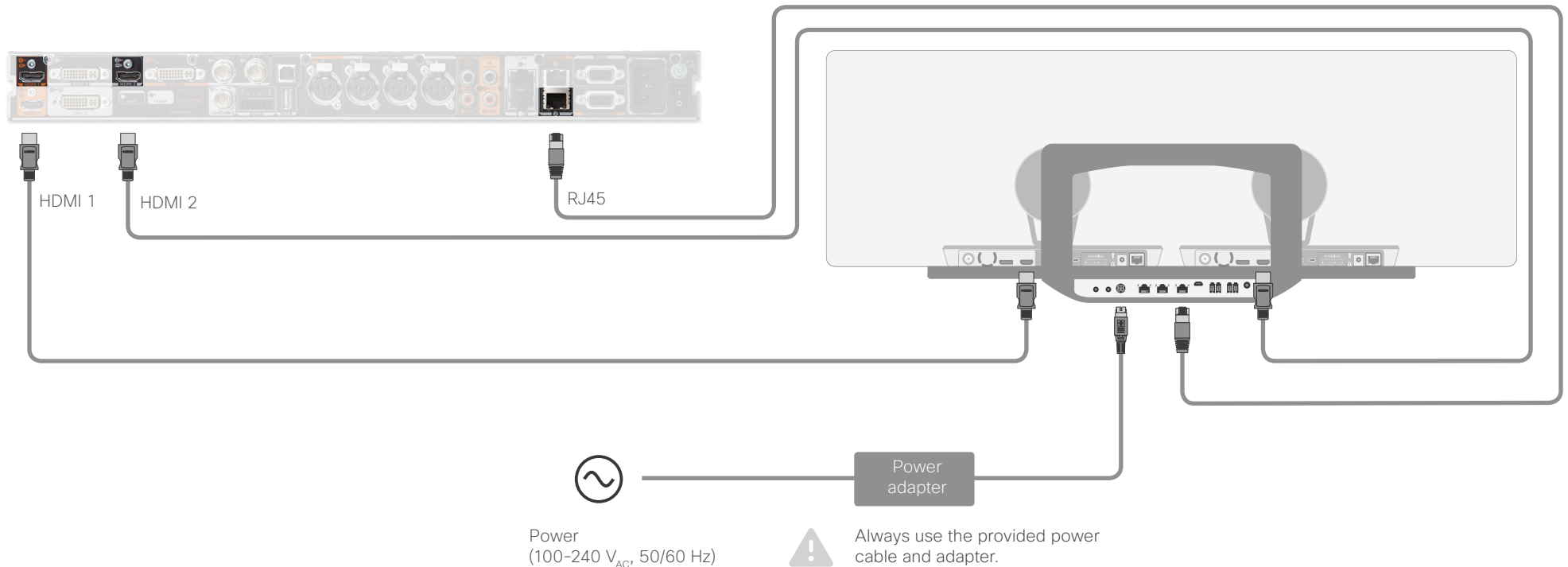

## Connect SpeakerTrack 60 to Codec C90

- Connect the video cables (HDMI).

Left camera: Connect between Connector 1 (HDMI input) on the codec to the HDMI input of the left camera.  
Right camera: Connect between Connector 2 (HDMI input) on the codec to the HDMI input of the right camera.

- Connect the camera control cable (Ethernet). Connect between the codec's 2nd Ethernet port and the Network port (Ethernet) on the SpeakerTrack 60 connector panel.
- Connect the power adapter to the SpeakerTrack 60 connector panel and connect to power.
- Connect other codec cables as described in the [Cisco TelePresence Codec C90 installation guide](#).

 When using a SpeakerTrack 60 with a C Series codec, the codec cannot be controlled with the TRC5 (Cisco Remote Control). Instead, a Cisco TelePresence Touch 8 user interface or an external control device must be used.

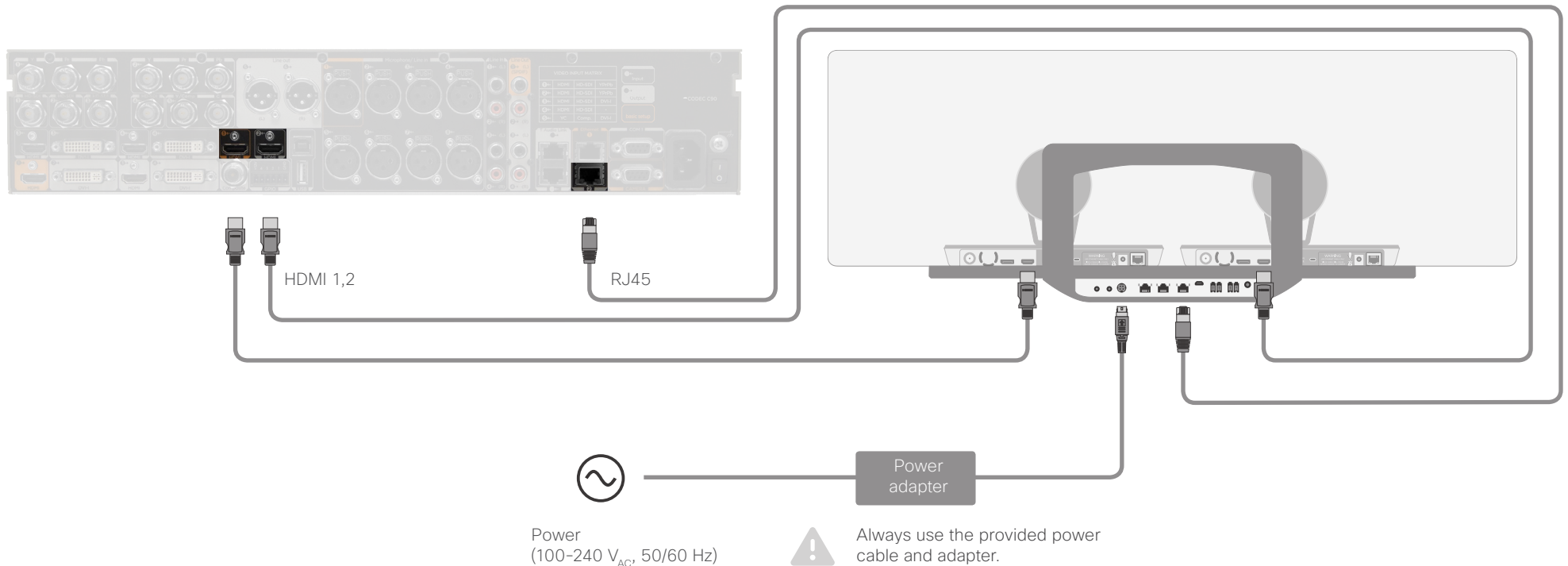

## Connect PTZ-12 to Codec Plus

- Connect the video cable (HDMI) between the camera and codec.  
Codec: Always use Connector 1 (HDMI input) for the main camera.  
Camera: Connect to the HDMI output.
- Connect the camera control cable (Ethernet) between the camera control ports on the camera and codec.  
Codec: The connector is marked with the camera control symbol.  
Camera: Connect to the Ethernet port.
- Connect the power adapter to the camera and connect to power.
- You can connect one PTZ-12 camera. Multiple cameras is not supported.
- Connect other codec cables as described in the [Cisco Webex Room Kit Plus PTZ-12 installation guide](#).

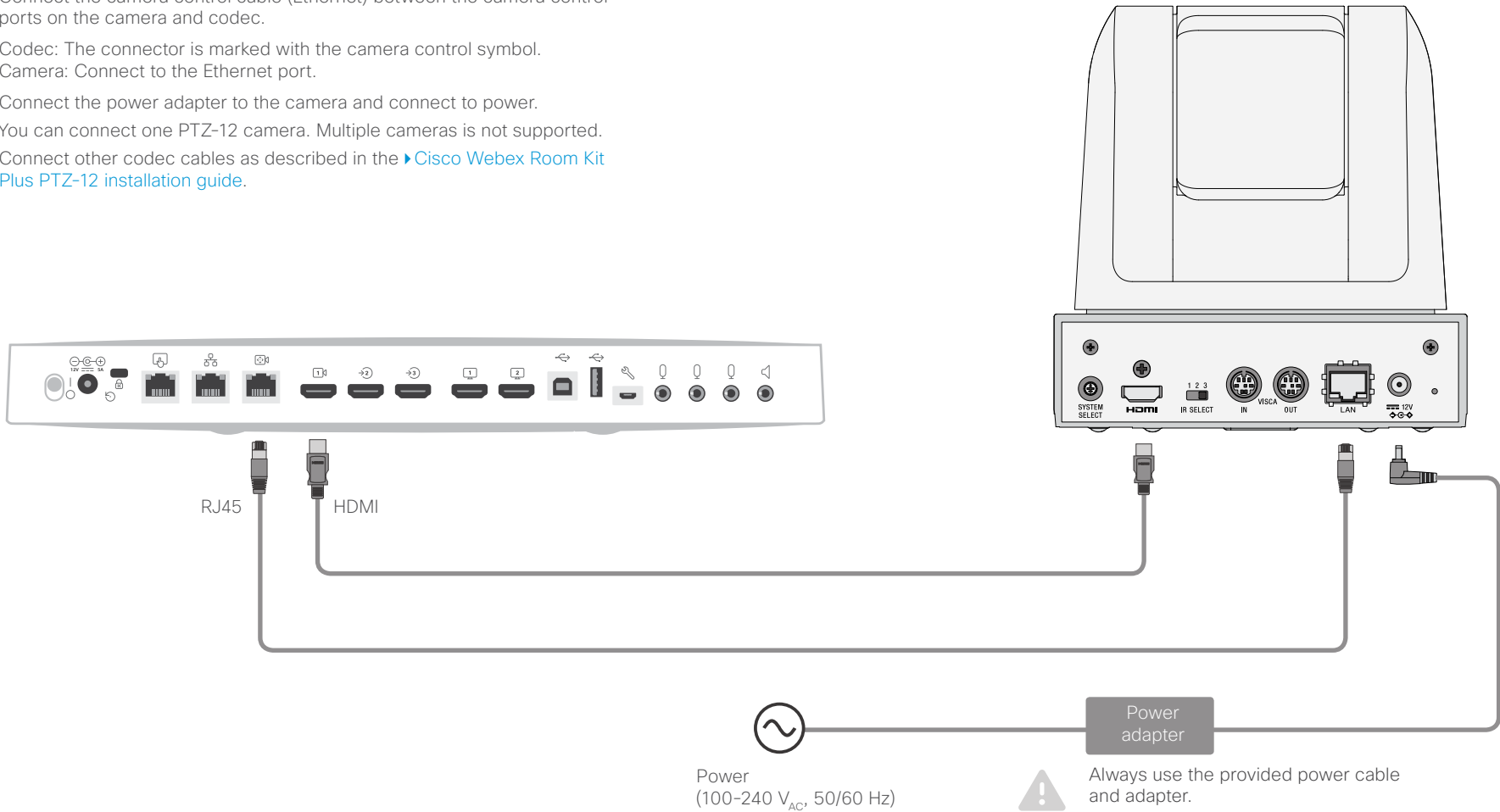



## Connecting multiple cameras to the Codec Pro

### Main camera

Normally you should use Connector 1 (HDMI) on the codec for the main camera. When the main camera is a Quad Camera, always use Connector 1 (HDMI) on the codec for this camera. If you are using 3G SDI from the Precision 60 Camera as the main camera, then the Connector 6 will be for the main camera.

### Using the HD-BNC connector

You can connect a Precision 60 camera to the codec using a coaxial cable for the video signal (3G SDI). Because the camera has a BNC connector and the codec has an HD-BNC connector, you will need a BNC to HD-BNC cable or a BNC to HD-BNC adapter. For camera control, connect the camera control cable (Ethernet) between the camera control ports.

### Adding multiple cameras

The Codec Pro supports up to seven cameras. The codec has six video input connectors for cameras and content.

- For six cameras and no content, all six video inputs can be used for cameras.
- If the total number of input sources (cameras and content) exceeds six, you will need an external video switch. If any of the cameras are connected through the video switch you will need a program (macro) to change camera IDs in the API.
- If you need more than two Ethernet ports for camera control, then you will need an Ethernet switch.
- Only one camera with speaker track functionality can be connected at the time. Cameras with speaker track functionality, are the Quad Camera and SpeakerTrack 60

See the *Customization Guide* for details on macros and the use of an external video switch.

<https://www.cisco.com/c/en/us/support/col-laboration-endpoints/spark-room-kit-series/products-installation-and-configuration-guides-list.html>

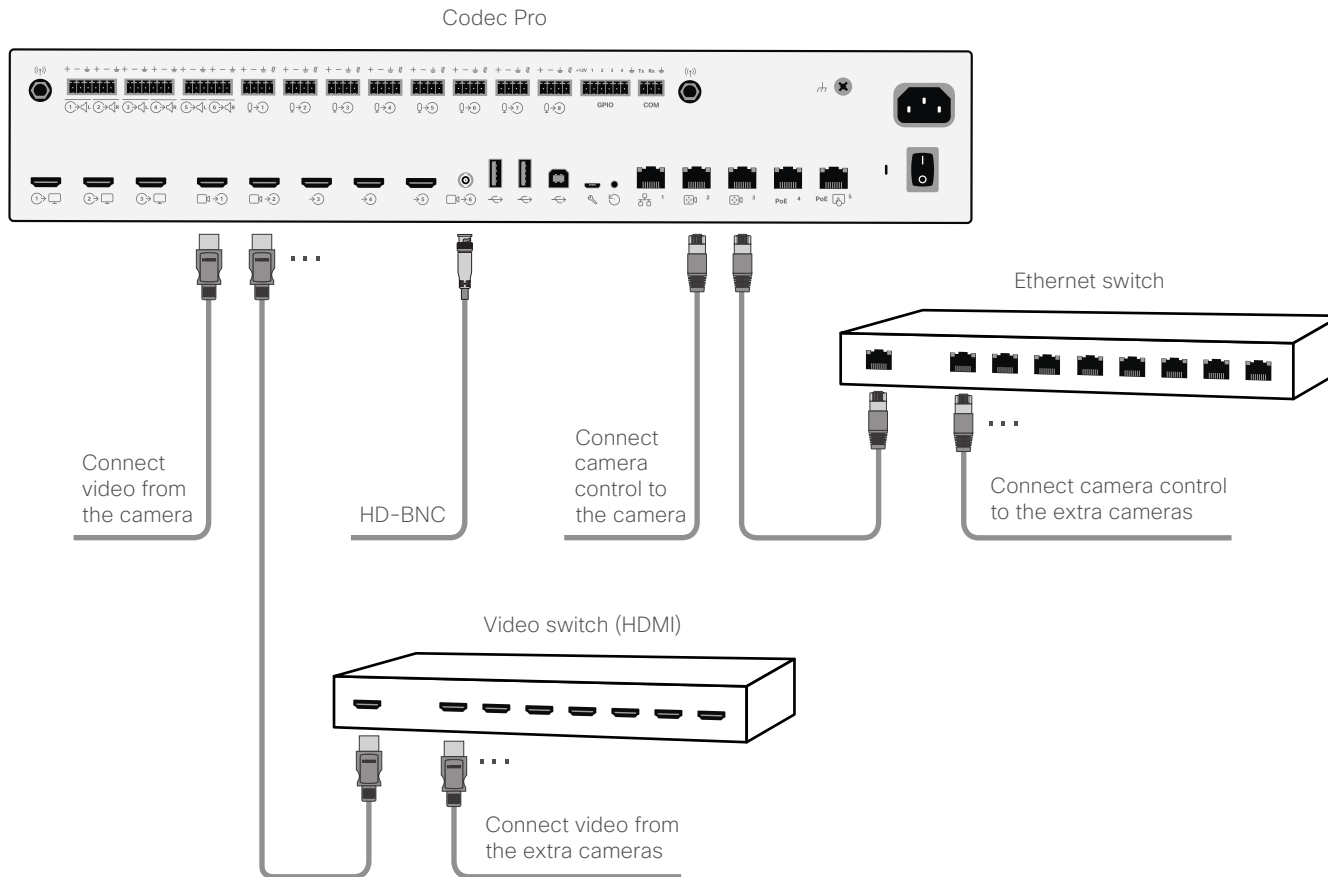

## Connecting multiple cameras to the SX80 codec

### Main camera

Normally you should use Video Input Connector 1 (HDMI) on the codec for the main camera.

### Using the analog video or DVI-I inputs

You can connect a third party analog camera to the analog video input on the codec. S-Video: Connect to both the Y and C connectors; Composite: Connect to the Y connector. Note that camera control is not available for this connector (Connector 5).



Note that the DVI-I and BNC video inputs are mutually excluding, you may only use either the DVI-I, the Composite, or the S-video at a time.

### Adding multiple cameras

The SX80 codec supports up to seven cameras. The codec has four simultaneous video input connectors for cameras and content.

- For four cameras and no content, all three HDMI inputs, and either the analog video input (BNC) or the DVI input can be used for cameras.
- If the total number of input sources (cameras and content) exceeds four, you will need an external video switch. If any of the cameras are connected through the video switch you will need a program (macro) to change camera IDs in the API.
- If you need more than two Ethernet ports for camera control or other devices (for example a Touch controller), then you will need an Ethernet switch.
- If you connect a camera to the DVI-I input, you must add the camera's serial number to be able to control the camera (Cameras > Camera n > AssignedSerialNumber).
- Only one camera with speaker track functionality can be connected at the time. Cameras with speaker track functionality, are the Quad Camera and SpeakerTrack 60.

See the *Customization Guide* for details on macros and the use of an external video switch.

<https://www.cisco.com/c/en/us/support/collaboration-endpoints/spark-room-kit-series/products-installation-and-configuration-guides-list.html>

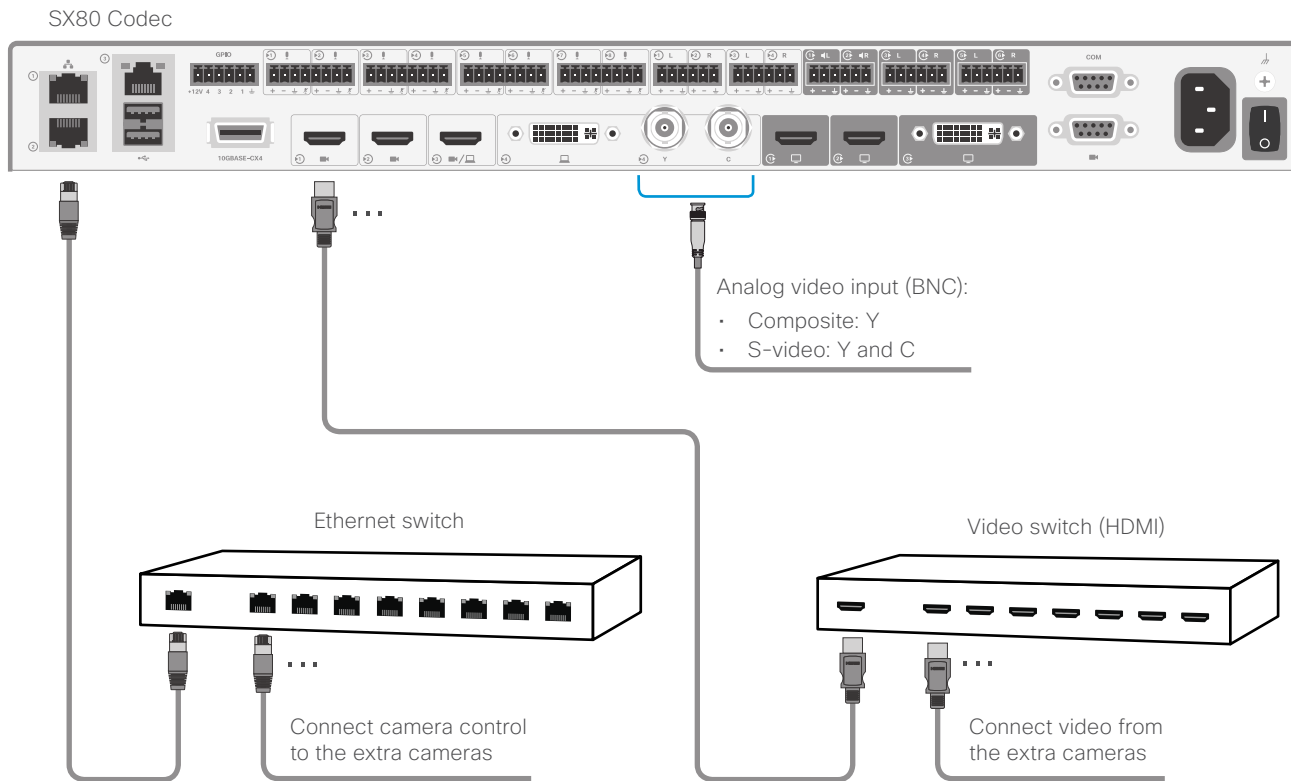

## CHAPTER 4

# *Factory reset*

## Quad Camera

A factory reset should only be performed by a system administrator or in contact with Cisco technical support.

The camera will be reset to factory defaults, and all configuration and logs will be erased.

**!** It is *not* possible to undo a factory reset.

To perform a factory reset:

1. Locate the pinhole button at the back of the camera.
2. Use a pen or similar to press and hold the factory reset button for about 6 seconds, until the white LED at the front of the camera starts blinking.
3. The system restarts two times to complete the factory reset operation. This procedure may take up to 5 minutes, depending on the software version.
4. The white LED will start pulsing normally once the factory reset operation is complete and the unit is starting normally.

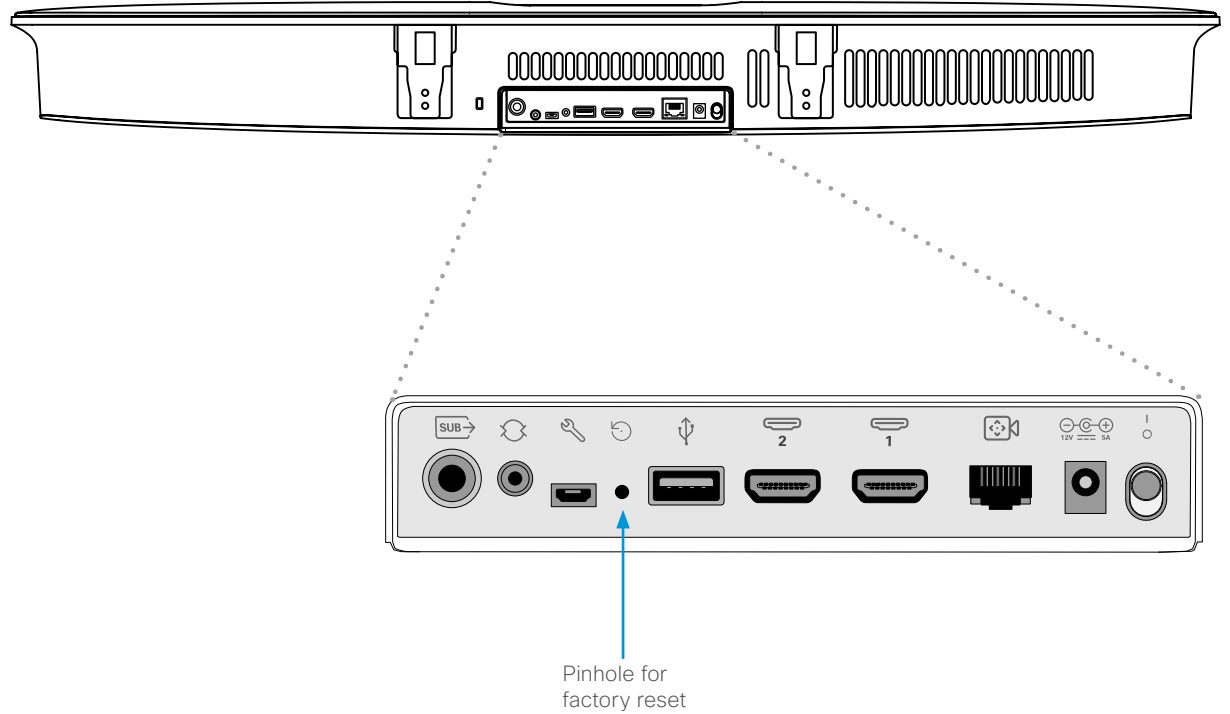

## Precision 60 Camera

A factory reset should only be performed by a system administrator or in contact with Cisco technical support.

The camera will be reset to factory defaults, and all configuration and logs will be erased.

 **It is *not* possible to undo a factory reset.**

To perform a factory reset:

1. Locate the pinhole button at the back of the camera.
2. Use a pen or similar to press and hold the factory reset button for 10 seconds.
3. The camera LED will be lit red during the factory reset.

 **Do not unplug power.**

4. When the factory reset is complete, the camera restarts and the camera LED lights up.

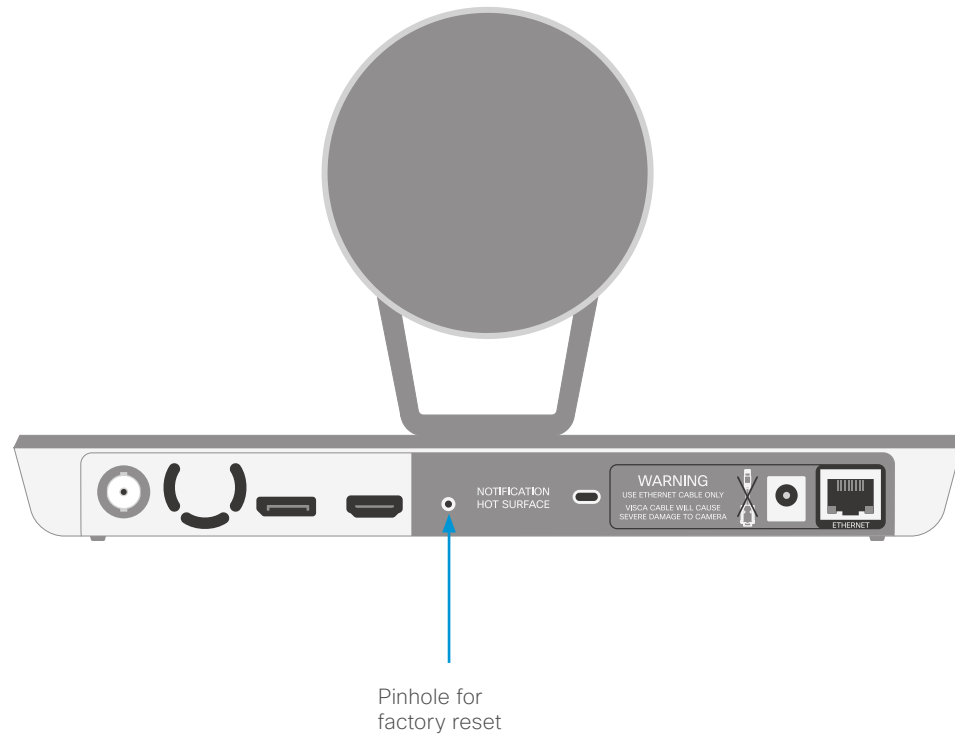

## SpeakerTrack 60 Camera

### Factory resetting the device

A factory reset should only be performed by a system administrator or in contact with Cisco technical support.

The device will be reset to factory defaults, and all configuration and logs will be erased.

If errors continue to occur, the cameras might have to be reset too. See the next page for instructions on how to reset the cameras.

 It is *not* possible to undo a factory reset.

To perform a factory reset:

1. Remove the top cover of the SpeakerTrack 60 device.
2. Locate the pinhole button at the top of the SpeakerTrack 60.
3. Use a pen or similar to press and hold the factory reset button for 10 seconds.
4. The camera LED will be lit red during the factory reset.

 Do not unplug power.

5. When the factory reset is complete, the device restarts and the LED lights up.

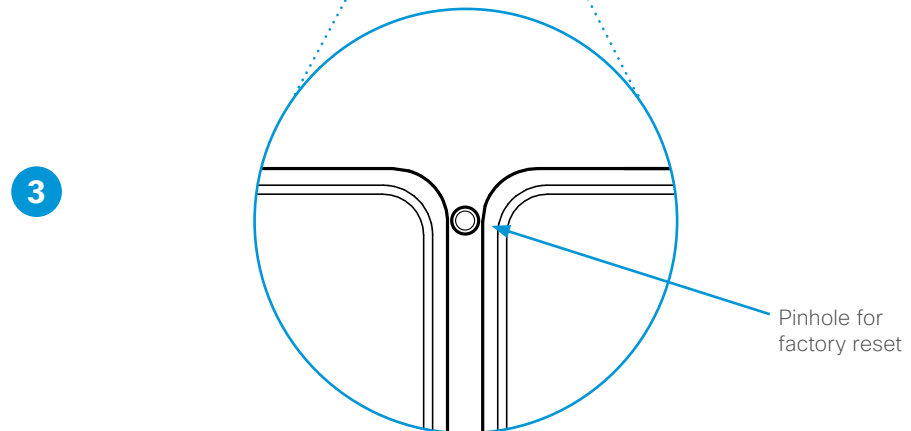
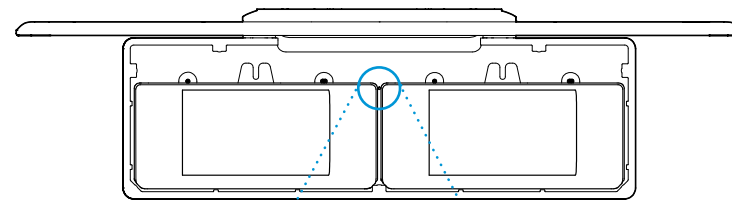
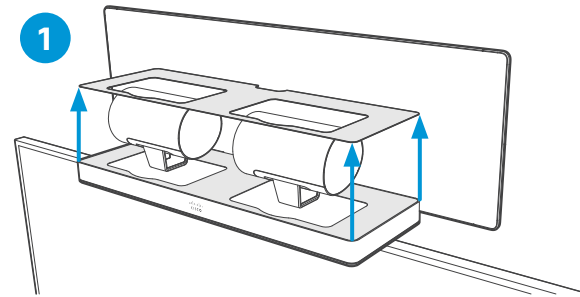

## SpeakerTrack 60 Camera

### Factory resetting the cameras

Lift the cameras from the carrier tray in order to reset them. The pinhole button is on the back panel of the camera.

A factory reset should only be performed by a system administrator or in contact with Cisco technical support.

The cameras will be reset to factory defaults, and all configuration and logs will be erased.

**!** It is *not* possible to undo a factory reset.

To perform a factory reset:

1. Remove the top cover of the SpeakerTrack 60 device.
2. Unscrew the wing nut that fastens the camera.
3. Locate the pinhole button at the back of the camera. See also the [Precision60 chapter](#).
4. Use a pen or similar to press and hold the factory reset button for 10 seconds.
5. The camera LED will be lit red during the factory reset.

**!** Do not unplug power.

6. When the factory reset is complete, the camera restarts and the camera LED lights up.
7. Set the camera back to the tray and tighten the wing nut (see picture 2 on the right).
8. Repeat steps 2-7 with the other camera.
9. Set back the top cover.

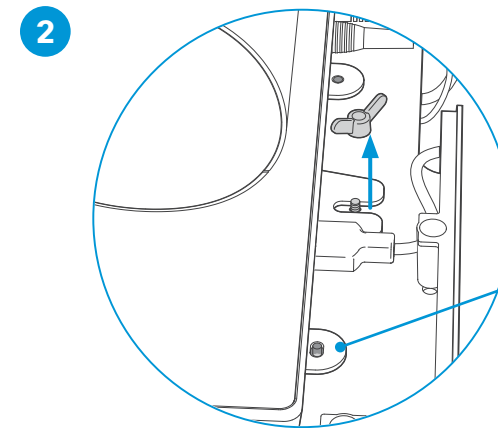
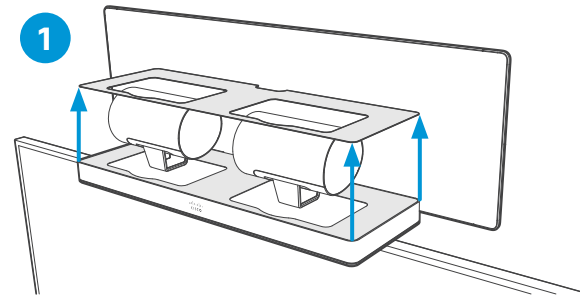

When replacing the camera, make sure the pins on the base plate fit the holes in the camera interface plate.

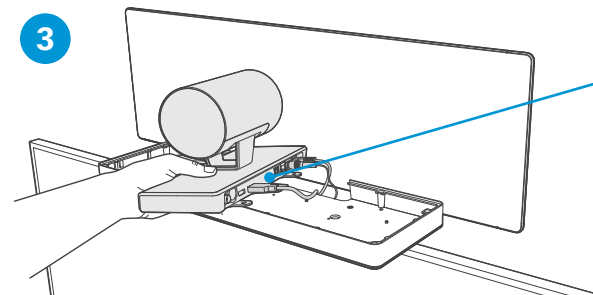

Locate the pinhole on the back panel of the camera.

CHAPTER 5

*Appendix*



## Technical specifications

### Quad Camera

- 5k Ultra HD camera
- 5120 x 2880 pixel resolution
- 5x digital zoom (3 tele-lenses each with 50° horizontal field of view)
- 83° horizontal field of view
- 51.5° vertical field of view
- Focus distance: 1.0m-∞ (wide)
- F-value: 2.0
- Support up to 60fps
- 15.1 MP image sensor
- Best-overview
- Camera control over Ethernet
- Automatic focus, brightness and white balance
- IP network features:
  - DNS lookup for service configuration
  - Date and Time support via NTP
  - TCP/IP
  - DHCP
- LAN/Ethernet (RJ45) 10/100/1000 Mbit network interface
- 2 HDMI connectors
- RCA subwoofer output
- Power adapter (FSP070-AHAN2, AcBel ADF019):
  - 100 to 240 V<sub>AC</sub>; 50/60 Hz, 12 V<sub>DC</sub> input
  - 12 V<sub>DC</sub>; Max.5.83 A output
- Operating temperature and humidity:
  - 0°C to 35°C (32°F to 195°F)
  - 10 to 90% relative humidity
- Storing and transport temperature and humidity:
  - -20°C to 60°C (-4°F to 140°F)
  - 10 to 90% relative humidity, non condensing
- Height: 120mm/4.7 in
- Width: 95mm/37.4 in
- Depth: 103 mm/4.0 in
- Weight: 4.8kg/10.6 lbs
- Part number: CS-QUADCAM=



 For more information about the camera dimension, refer to the [CAD drawings](#) on the Cisco website.

## Precision 60 Camera

- 1080p60 Full High Definition
- 10 x optical zoom
- 2x digital zoom
- 20x zoom combined
- Pan range:  $-100^{\circ}$  to  $+100^{\circ}$  ( $\pm 1^{\circ}$ )
- Tilt range:  $-20^{\circ}$  to  $+20^{\circ}$  ( $\pm 1^{\circ}$ )
- $80^{\circ}$  horizontal field of view
- $48.8^{\circ}$  vertical field of view
- Focus distance: 1.0m- $\infty$  (wide)
- F-value: 1.5
- Camera control over Ethernet
- Automatic or manual focus, brightness and white balance
- IP network features:
  - DNS lookup for service configuration
  - Date and Time support via NTP
  - TCP/IP
  - DHCP
- LAN/Ethernet (RJ45) 10/100 Mbit network interface
- HDMI and 3G-SDI video interfaces
- Power adapter (FSP040-DGAA1, FSP040-RHAN2):
  - Input: 100-120 or 200-240 V<sub>AC</sub>; 50 or 60 Hz
  - Output: 12 V<sub>DC</sub> / 3.33 A
- Operating temperature and humidity:
  - $0^{\circ}\text{C}$  to  $40^{\circ}\text{C}$  ( $32^{\circ}\text{F}$  to  $104^{\circ}\text{F}$ )
  - 10 to 90% relative humidity
- Storing and transport temperature and humidity:
  - $-20^{\circ}\text{C}$  to  $60^{\circ}\text{C}$  ( $-4^{\circ}\text{F}$  to  $140^{\circ}\text{F}$ )
  - 10 to 90 % relative humidity, non condensing
- Height: 152 mm/6.0in
- Width: 268 mm/10.6in
- Depth: 163 mm/6.4 in
- Weight: 2.5 kg/5.5 lbs
- Part number: CTS-CAM-P60=

 For more information about the camera dimension, refer to the [CAD drawings](#) on the Cisco website.



## SpeakerTrack 60 Camera

- 1080p60 Full High Definition
- 10x optical zoom
- 2x digital zoom
- 20x zoom combined
- Pan range:  $-100^{\circ}$  to  $+100^{\circ}$  ( $\pm 1^{\circ}$ )
- Tilt range:  $-20^{\circ}$  to  $+20^{\circ}$  ( $\pm 1^{\circ}$ )
- $80^{\circ}$  horizontal field of view (FoV)
- $48.8^{\circ}$  vertical FoV
- Tracking horizontal FoV:  $80^{\circ}$
- Focus distance: 1.0m- $\infty$  (wide)
- F-value: 1.5
- Camera control over Ethernet
- Automatic or manual focus, brightness and white balance
- IP network features:
  - DNS lookup for service configuration
  - Date and Time support via NTP
  - TCP/IP
  - DHCP
- LAN/Ethernet (RJ45) 10/100 Mbit network interface
- HDMI 1.4 video interface
- Power adapter (FSP084-DIBAN2):
  - Input: 100-120 or 200-240 V<sub>AC</sub>; 50 or 60 Hz
  - Output: 12 V<sub>DC</sub> / 7 A
- Operating temperature and humidity:
  - $0^{\circ}\text{C}$  to  $40^{\circ}\text{C}$  ( $32^{\circ}\text{F}$  to  $104^{\circ}\text{F}$ )
  - 10 to 90 % relative humidity
- Storing and transport temperature and humidity:
  - $-20^{\circ}\text{C}$  to  $60^{\circ}\text{C}$  ( $-4^{\circ}\text{F}$  to  $140^{\circ}\text{F}$ )
  - 10 to 90 % relative humidity, non condensing
- Compatibility information:
  - Compatible with C40, C60, C90 and SX80 codecs
  - Requires a Cisco Touch 8 or Touch 10 user interface (unless a control system is used)
- Height: 292 mm/11.5 in
- Width: 800 mm/31.5 in
- Depth: 210 mm/8.3 in
- Weight: 11.5 kg/25.4 lbs
- Part number: CTS-SPKER-TRACK60



 For more information about the camera dimension, refer to the [CAD drawings](#) on the Cisco website.

## PTZ-12 Camera

- 1080p60 Full High Definition
- 12x optical zoom
- 12x digital zoom
- Pan range: -100° to +100°
- Tilt range: -25° to +25°
- 71° horizontal field of view (FoV)
- Installation angle: Less than -15° to +15° to the horizontal surface
- F-value: 1.8 to 2.0
- Camera control over Ethernet
- Automatic or manual focus, brightness and white balance
- LAN/Ethernet (RJ45) 10/100 Mbit network interface
- HDMI video: Type A (19-pin)
- AC Power adapter (JEITA type4):
- Input voltage: 12V<sub>DC</sub>, 1.4 A.
- Operating temperature and humidity:
  - 0°C to 40°C (32°F to 104°F)
- Storing and transport temperature and humidity:
  - -20°C to 60 °C (-4°F to 140°F)
- Compatibility information:
  - Compatible with Codec Plus
- Height: 156 mm/6.14 in
- Width: 153 mm/6.02 in
- Depth: 153 mm/6.02 in
- Weight: 1.46 kg
- Part number: CS-CAM-PTZ12=

For more information about the camera dimension, refer to the [CAD drawings](#) on the Cisco website.



THE SPECIFICATIONS AND INFORMATION REGARDING THE PRODUCTS IN THIS MANUAL ARE SUBJECT TO CHANGE WITHOUT NOTICE. ALL STATEMENTS, INFORMATION, AND RECOMMENDATIONS IN THIS MANUAL ARE BELIEVED TO BE ACCURATE BUT ARE PRESENTED WITHOUT WARRANTY OF ANY KIND, EXPRESS OR IMPLIED. USERS MUST TAKE FULL RESPONSIBILITY FOR THEIR APPLICATION OF ANY PRODUCTS.

THE SOFTWARE LICENSE AND LIMITED WARRANTY FOR THE ACCOMPANYING PRODUCT ARE SET FORTH IN THE INFORMATION PACKET THAT SHIPPED WITH THE PRODUCT AND ARE INCORPORATED HEREIN BY THIS REFERENCE. IF YOU ARE UNABLE TO LOCATE THE SOFTWARE LICENSE OR LIMITED WARRANTY, CONTACT YOUR CISCO REPRESENTATIVE FOR A COPY.

The Cisco implementation of TCP header compression is an adaptation of a program developed by the University of California, Berkeley (UCB) as part of UCB's public domain version of the UNIX operating system. All rights reserved. Copyright © 1981, Regents of the University of California.

NOTWITHSTANDING ANY OTHER WARRANTY HEREIN, ALL DOCUMENT FILES AND SOFTWARE OF THESE SUPPLIERS ARE PROVIDED "AS IS" WITH ALL FAULTS. CISCO AND THE ABOVE-NAMED SUPPLIERS DISCLAIM ALL WARRANTIES, EXPRESSED OR IMPLIED, INCLUDING, WITHOUT LIMITATION, THOSE OF MERCHANTABILITY, FITNESS FOR A PARTICULAR PURPOSE AND NONINFRINGEMENT OR ARISING FROM A COURSE OF DEALING, USAGE, OR TRADE PRACTICE.

IN NO EVENT SHALL CISCO OR ITS SUPPLIERS BE LIABLE FOR ANY INDIRECT, SPECIAL, CONSEQUENTIAL, OR INCIDENTAL DAMAGES, INCLUDING, WITHOUT LIMITATION, LOST PROFITS OR LOSS OR DAMAGE TO DATA ARISING OUT OF THE USE OR INABILITY TO USE THIS MANUAL, EVEN IF CISCO OR ITS SUPPLIERS HAVE BEEN ADVISED OF THE POSSIBILITY OF SUCH DAMAGES.

Any Internet Protocol (IP) addresses and phone numbers used in this document are not intended to be actual addresses and phone numbers. Any examples, command display output, network topology diagrams, and other figures included in the document are shown for illustrative purposes only. Any use of actual IP addresses or phone numbers in illustrative content is unintentional and coincidental.

All printed copies and duplicate soft copies of this document are considered uncontrolled. See the current online version for the latest version.

Cisco has more than 200 offices worldwide. Addresses, phone numbers, and fax numbers are listed on the Cisco website at [www.cisco.com/go/offices](http://www.cisco.com/go/offices).

Cisco and the Cisco logo are trademarks or registered trademarks of Cisco and/or its affiliates in the U.S. and other countries. To view a list of Cisco trademarks, go to this URL: [www.cisco.com/go/trademarks](http://www.cisco.com/go/trademarks). Third-party trademarks mentioned are the property of their respective owners. The use of the word partner does not imply a partnership relationship between Cisco and any other company. (1110R)

## Contact us

You will find an overview of the worldwide Cisco contacts on our website.

Go to: [▶ https://www.cisco.com/go/offices](https://www.cisco.com/go/offices)

Corporate Headquarters  
Cisco Systems, Inc.  
170 West Tasman Dr.  
San Jose, CA 95134 USA

## Free Manuals Download Website

<http://myh66.com>

<http://usermanuals.us>

<http://www.somanuals.com>

<http://www.4manuals.cc>

<http://www.manual-lib.com>

<http://www.404manual.com>

<http://www.luxmanual.com>

<http://aubethermostatmanual.com>

Golf course search by state

<http://golfingnear.com>

Email search by domain

<http://emailbydomain.com>

Auto manuals search

<http://auto.somanuals.com>

TV manuals search

<http://tv.somanuals.com>