

S-604 / S-604-25 FLEXHORN FOUR WATT PAGING HORN

INTRODUCTION

The Clarity Four Watt FlexHorn is designed to provide voice paging as well as background music. This horn is weatherproof and can be used indoors or outside in environments ranging from -20 to +55 degrees C. Different wattage taps to the transformer are achieved by connecting to the color coded cable. The horn is available in gray, beige, and white.

Model S-604-W	White
Model S-604-GY	Gray
Model S-604-BGE	Beige
Model S-604-25-W	White
Model S-604-25-GY	Gray
Model S-604-25-BGE	Beige



WIRING

Wattage Taps	
Color	Designation
Black	Common
White	.5 Watt
Brown	1 Watt
Green	2 Watts
Red	4 Watts

MOUNTING INSTRUCTIONS

FLUSH MOUNT

Using the template (box insert) packaged with the speaker, draw the speaker outline on the wall to be cut. Make appropriate wiring connections (see Wiring) and test the speaker for operation. Using appropriate mounting screws (not furnished), drill and mount the flange as shown.

UNIVERSAL BRACKET

Loosen or separate the universal bracket leaves by loosening or removing the handle and hardware. Using the back leaf as a template, mark the wall through the mounting holes, drill and mount to the wall using appropriate screws (not furnished) or mount directly to a junction box. Mount the T-bracket to the back of the horn as shown using the (2) 1/2" screws provided.

"C" CLAMP FOR "I" BEAM MOUNTING

A "C" clamp is provided with the horns to allow mounting to a beam. Place the bolt through the hole in the bottom of the base to secure the "C" clamp to the beam. It is suggested that the horn be mounted to the underside of the "I" beam to provide the maximum of positioning adjustments. Mount "C" clamp with (2) 1/2" screws provided.

TECHNICAL ASSISTANCE

When trouble is reported, verify that AC power is being supplied to the unit and there are no shorts or grounds on cabling.

Assistance in troubleshooting is available from the factory. When calling, you should have a VOM available and be calling from the job site. Call (540) 563-2000 and ask for Technical Support or (540) 767-1555 for Clarity 24-hour Automated Support.

Visit our website at <http://www.clarity-com.com>.

CLARITY equipment is not field repairable. CLARITY maintains service facilities in Roanoke, VA. Should repairs be necessary, attach a tag to the unit clearly stating company name, address, phone number, contact person, and the nature of the problem. Send the unit to:

Clarity
Repair and Return Dept.
5614 Hollins Road
Roanoke, VA 24019-5056

LIMITED WARRANTY

Clarity warrants its products to be free from defects in materials and workmanship under conditions of normal use and service for a period of one year from the date of shipment. The obligation under this warranty shall be limited to the replacement, repair or refund of any such defective device within the warranty period, provided that:

1. Inspection by Clarity indicates the validity of the claim;
2. The defect is not the result of damage, misuse, or negligence after the original shipment;
3. The product has not been in any way repaired by others and that factory sealed units are unopened (A service charge plus parts and labor will be applied to units defaced or physically damaged);
4. Freight charges for the return of products to Clarity are prepaid,
5. All units "out of warranty" are subject to a service charge. The service charge will cover minor repairs (Major repairs will be subject to additional charges for parts and labor).

This warranty is in lieu of and excludes all other warranties, expressed or implied, and in no event shall Clarity be liable for any anticipated profits, consequential damages, loss of time or other losses incurred by the buyer in connection with the purchase, operation, or use of the product.

This warranty specifically excludes damage incurred in shipment. In the event a product is received in damaged condition, the carrier should be notified immediately. Claims for such damage should be filed with the carrier involved in accordance with the F.O.B. point.

UNIVERSAL BRACKET

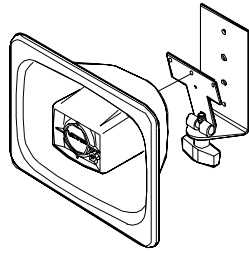

SURFACE MOUNTED WITH A
UNIVERSAL MOUNTING BRACKET

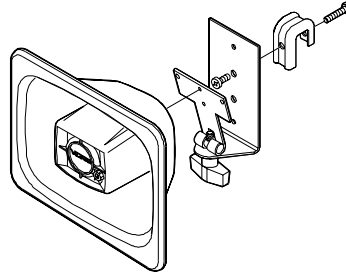

UNIVERSAL BRACKET WITH CLAMP

"C" CLAMP FOR "I" BEAM MOUNTING

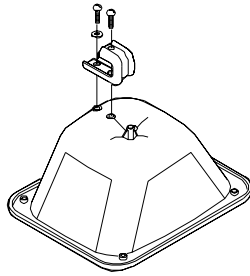

ATTACH CLAMP TO HORN

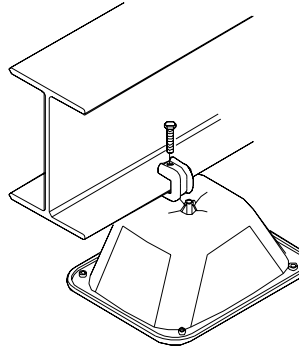

ATTACH FLEXHORN TO BEAM

FLUSH MOUNT USING MOUNTING SCREWS:

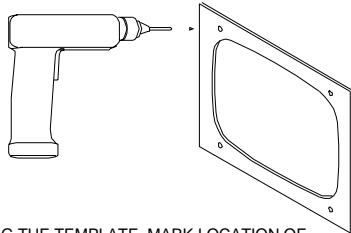

USING THE TEMPLATE, MARK LOCATION OF
OPENING AND MOUNTING HOLES ON WALL.
DRILL HOLES APPROPRIATE TO MOUNTING
HARDWARE AND CUT OUT THE OPENING.

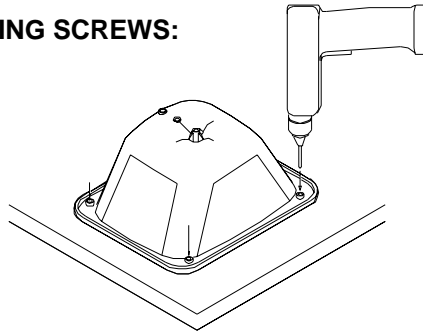

HOLDING FLEXHORN FIRMLY AGAINST A FLAT
SURFACE, DRILL THROUGH EACH MOUNTING BOSS
AS SHOWN.

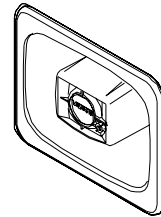

FLUSH MOUNTING IN A STUD WALL
INSTALLED WITH MOUNTING SCREWS
OR CONSTRUCTION CEMENT.

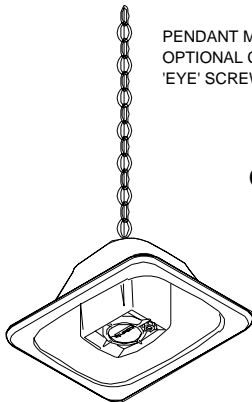

PENDANT MOUNTING WITH
OPTIONAL CHAIN AND
'EYE' SCREW

OTHER MOUNTING OPTIONS:

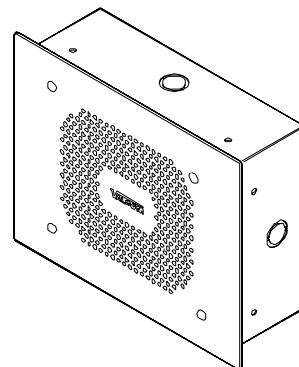

OPTIONAL V-9805
VANDAL RESISTANT ENCLOSURE

Free Manuals Download Website

<http://myh66.com>

<http://usermanuals.us>

<http://www.somanuals.com>

<http://www.4manuals.cc>

<http://www.manual-lib.com>

<http://www.404manual.com>

<http://www.luxmanual.com>

<http://aubethermostatmanual.com>

Golf course search by state

<http://golfingnear.com>

Email search by domain

<http://emailbydomain.com>

Auto manuals search

<http://auto.somanuals.com>

TV manuals search

<http://tv.somanuals.com>