

# **ClearOne**® **Aura**™

Quick-Start Guide



**UNITE® 180 4K**  
**Panoramic Camera**

## Contact Information

### Headquarters

5225 Wiley Post Way  
Suite 500  
Salt Lake City, UT 84116  
US: +1.801.975.7200  
International: +1.801.975.7200

### Aura Sales

US: +1.888.HEY.AURA  
International: +1.801.975.7200  
aurasales@clearone.com

### Aura Tech Support

US: +1.888.HEY.AURA  
International: +1.801.975.7200  
auratechsupport@clearone.com

© 2021 ClearOne, Inc. All rights reserved.



Information in this document is subject to change without notice.

Document: QSG-0131-002v1.1, August 2021

## Important Safety Information

1. Before you set up the camera, read this manual carefully. Follow the setup instructions indicated in this manual.
2. Keep this manual for future use.
3. To prevent electric shock, do not remove screws or the camera housing. No self-serviceable parts are inside the housing.
4. Avoid direct sunlight or other heat sources. Keep unit away from moisture and humidity. Avoid inserting any sharp objects into the product. Avoid dropping the product to avoid damage.
5. Normal operating temperature is 32 to 104 °F (0 to 40 °C)
6. Careful installation
  - Install the camera on a smooth desktop or on the top of a computer monitor.
7. Do not disassemble
  - Damage caused by the user's disassembly is not covered by warranty.
8. Power
  - Use only the included adaptor to power the camera.
9. Electromagnetic fields at specific frequencies may affect the camera's image.

**WARNING: TO PREVENT FIRE OR ELECTRICAL SHOCK HAZARD, DO NOT EXPOSE THIS PRODUCT TO RAIN OR MOISTURE**

|                                                                                                                                                                                                                         |                                                                                                                                                                                                                                                                                                           |                                                                                                                                                                                                                          |
|-------------------------------------------------------------------------------------------------------------------------------------------------------------------------------------------------------------------------|-----------------------------------------------------------------------------------------------------------------------------------------------------------------------------------------------------------------------------------------------------------------------------------------------------------|--------------------------------------------------------------------------------------------------------------------------------------------------------------------------------------------------------------------------|
|  <p>THE LIGHTING FLASH AND ARROWHEAD WITHIN THE TRIANGLE IS A WARNING SIGN ALERTING YOU OF DANGEROUS VOLTAGE INSIDE THE PRODUCT.</p> | <p><b>CAUTION</b></p> <p><b>RISK OF ELECTRIC SHOCK DO NOT OPEN</b></p> <p><b>AVIS RISQUE DU CHOC ELECTRIQUE - NE PAS OUVRIR</b></p> <p>CAUTION: TO REDUCE THE RISK OF ELECTRIC SHOCK, DO NOT REMOVE COVER (OR BACK) NO USER SERVICEABLE PARTS INSIDE. REFER SERVICING TO QUALIFIED SERVICE PERSONNEL.</p> |  <p>THE EXCLAMATION POINT WITHIN THE TRIANGLE IS A WARNING SIGN ALERTING YOU OF IMPORTANT INSTRUCTIONS ACCOMPANYING THE PRODUCT.</p> |
| <p>SEE MARKING ON BOTTOM/BACK OF PRODUCT</p>                                                                                                                                                                            |                                                                                                                                                                                                                                                                                                           |                                                                                                                                                                                                                          |



Use only in non-tropical locations.



Use only at altitudes of 2000 meters or less.

## Packing List



Camera



Cable, USB 2.0, Type A Male to Type C Male, 3 ft. (1)

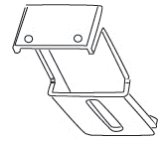

Wall bracket (x1)



Thumb screw  
1/2-20-LS mm  
(x1)



Rubber expansion  
plug (x 2)



KA4 x 30 self-tapping  
screw (x2)

Carefully inspect the shipment. If the shipment shows obvious signs of damage, retain the box and packing material for inspection by the carrier. Contact the carrier immediately.

ClearOne is not responsible for product damage incurred during shipment.

## Installation

### Wall Mounting

- Use a 1/4 in (6 mm) drill bit to drill two holes with a horizontal spacing of 1.1 in (28 mm) on the wall.
- Push a rubber expansion plug into each hole.
- Use a #2 Phillips screwdriver and the two self-tapping screws to attach the wall bracket to the wall.

### Expansion screw mounting holes

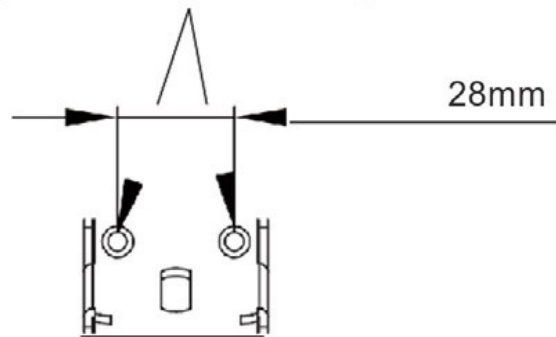

- Use the thumb screws to secure the camera to the bracket.

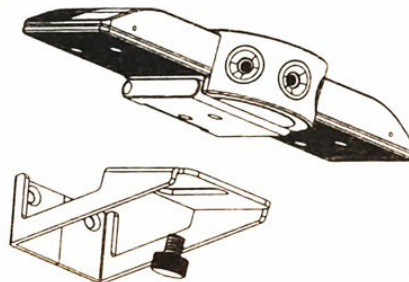

## Monitor Mounting

- On the underside of the camera body, open the damped rotating shaft bracket.

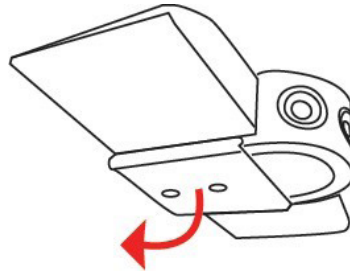

- Place camera on top of a flat-panel monitor and adjust to your preferred position.

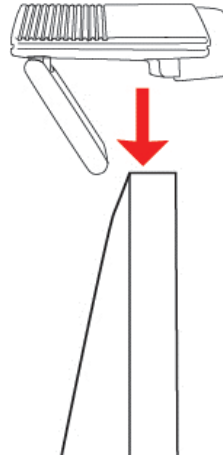

## Connections

Use the included USB cable to connect the UNITE 180 to your computer.

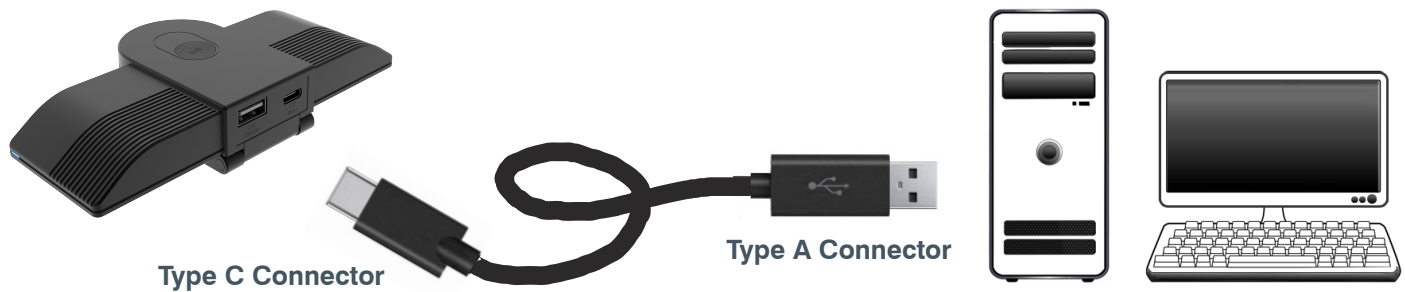

## Starting Up and Selecting a Viewing Mode

Immediately after you connect the UNITE 180 to a computer (if the computer is powered-on), Windows recognizes the UNITE 180 and the camera is available to use with your video collaboration software.

Six viewing modes are available with the UNITE 180, as follows:

- Compose
- Autoframing
- Presentation
- Manual
- Grid
- Speaker

To change the viewing mode, lightly tap the button on the top of the camera.



An explanation of the viewing modes is included in the UNITE 180 datasheet, available in [ClearOne's Resource Library](#). Details about how to use more powerful features of the UNITE 180 are included in the UNITE 180 User Manual, available in [ClearOne's Resource Library](#).

## Troubleshooting

| Problem           | Resolution                                                |
|-------------------|-----------------------------------------------------------|
| The Image jitters | Check stability of the location: Remove vibrating objects |
| The image flashes | Eliminate unstable lighting.                              |

## Free Manuals Download Website

<http://myh66.com>

<http://usermanuals.us>

<http://www.somanuals.com>

<http://www.4manuals.cc>

<http://www.manual-lib.com>

<http://www.404manual.com>

<http://www.luxmanual.com>

<http://aubethermostatmanual.com>

Golf course search by state

<http://golfingnear.com>

Email search by domain

<http://emailbydomain.com>

Auto manuals search

<http://auto.somanuals.com>

TV manuals search

<http://tv.somanuals.com>