

ClearOne®

UNITE 180® 4K Panoramic Camera



ClearOne® Contacts

Headquarters

5225 Wiley Post Way Suite 500
Salt Lake City, UT 84116

Sales

Tel: +1.801.975.7200
sales@clearone.com

Headquarters

Tel: +1.801.975-7200

Technical Support

Tel: +1.801.974.3760
videotechsupport@clearone.com

Notices

© 2021 ClearOne, Inc. All rights reserved.



Information in this document is subject to change without notice.

Document: QSG-0131-001v1.3, September 2021

Important Safety Information

1. Before you set up the camera, read this manual carefully. Follow the setup instructions indicated in this manual.
2. Keep this manual for future use.
3. To prevent electric shock, do not remove screws or the camera housing. No self-serviceable parts are inside the housing.
4. Avoid direct sunlight or other heat sources. Keep unit away from moisture and humidity. Avoid inserting any sharp objects into the product. Avoid dropping the product to avoid damage.
5. Normal operating temperature is 32 to 104 °F (0 to 40 °C)
6. Careful installation
 - Install the camera on a smooth desktop or on the top of a computer monitor.
7. Do not disassemble
 - Damage caused by the user's disassembly is not covered by warranty.
8. Power
 - Use only the included adaptor to power the camera.
9. Electromagnetic fields at specific frequencies may affect the camera's image.

WARNING: TO PREVENT FIRE OR ELECTRICAL SHOCK HAZARD, DO NOT EXPOSE THIS PRODUCT TO RAIN OR MOISTURE

 <p>THE LIGHTNING FLASH AND ARROWHEAD WITHIN THE TRIANGLE IS A WARNING SIGN ALERTING YOU OF DANGEROUS VOLTAGE INSIDE THE PRODUCT.</p>	CAUTION RISK OF ELECTRIC SHOCK DO NOT OPEN AVIS RISQUE DU CHOC ELECTRIQUE - NE PAS OUVRIR CAUTION: TO REDUCE THE RISK OF ELECTRIC SHOCK, DO NOT REMOVE COVER (OR BACK) NO USER SERVICEABLE PARTS INSIDE. REFER SERVICING TO QUALIFIED SERVICE PERSONNEL.	 <p>THE EXCLAMATION POINT WITHIN THE TRIANGLE IS A WARNING SIGN ALERTING YOU OF IMPORTANT INSTRUCTIONS ACCOMPANYING THE PRODUCT.</p>
SEE MARKING ON BOTTOM/BACK OF PRODUCT		

Use only in non-tropical locations.

Use only at altitudes of 2000 meters or less.

Packing List



Camera



Cable, USB 2.0, Type A Male to Type C Male, 3 ft. (1)

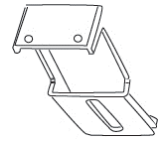

Wall bracket (x1)



Thumb screw
1/2-20-LS mm
(x1)



Rubber expansion
plug (x 2)



KA4 x 30 self-tapping
screw (x2)

Carefully inspect the shipment. If the shipment shows obvious signs of damage, retain the box and packing material for inspection by the carrier. Contact the carrier immediately.

ClearOne is not responsible for product damage incurred during shipment.

Installation

Wall Mounting

- Use a 1/4 in (6 mm) drill bit to drill two holes with a horizontal spacing of 1.1 in (28 mm) on the wall.
- Push a rubber expansion plug into each hole.
- Use a #2 Phillips screwdriver and the two self-tapping screws to attach the wall bracket to the wall.

Expansion screw mounting holes

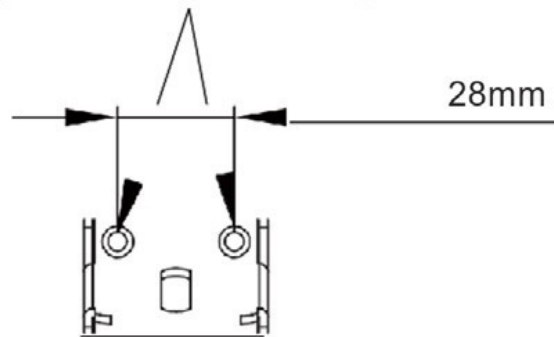

- Use the thumb screws to secure the camera to the bracket.

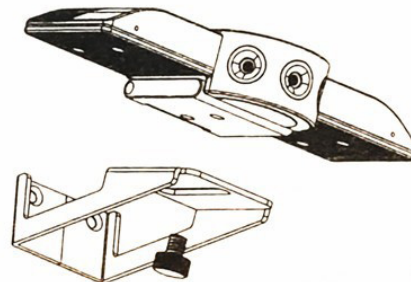

Monitor Mounting

- On the underside of the camera body, open the damped rotating shaft bracket.

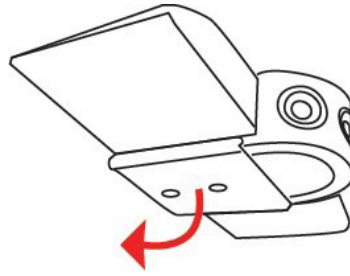

- Place camera on top of a flat-panel monitor and adjust to your preferred position.

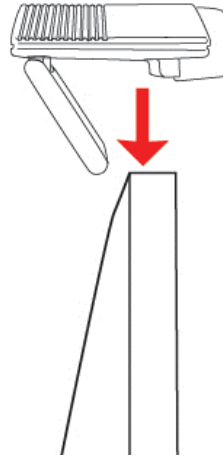

Connections

Use the included USB cable to connect the UNITE 180 to your computer.

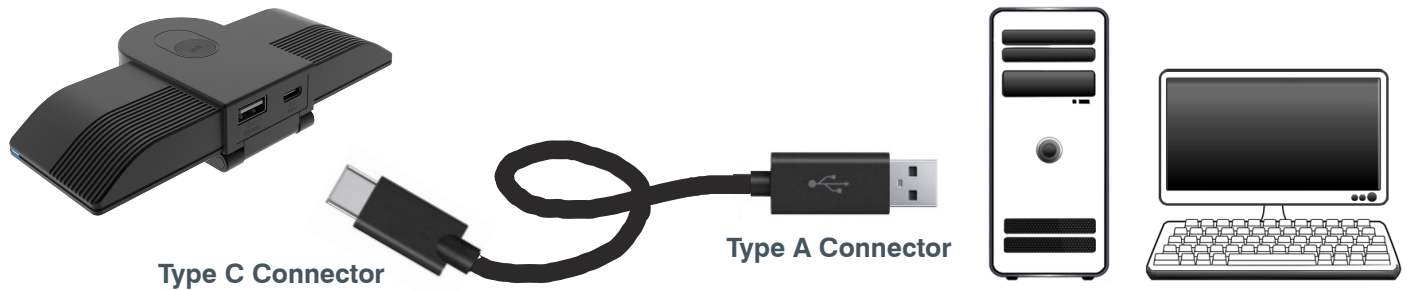

The UNITE 180's Type A port, labeled **2.0 Host**, can be used as a pass-through, to connect other devices such as a CHAT 50.



Starting Up and Selecting a View

Immediately after you connect the UNITE 180 to a computer (if the computer is powered-on), Windows recognizes the UNITE 180 and the camera is available to use with your video collaboration software.

Five view settings are available with the UNITE 180, as follows:

- Compose - 180° view / 3 fixed close-up images
- 180° View
- Center View - 2x zoom image
- Grid - 4 fixed images
- Speaker - center screen 2x zoom/180° view



To change the view setting, lightly tap the button on the top of the camera.



Accessing Advanced Features

The camera’s advanced features, such as full 180° panoramic field-of-view and participant close-ups, are available via PanoCAM Studio software.

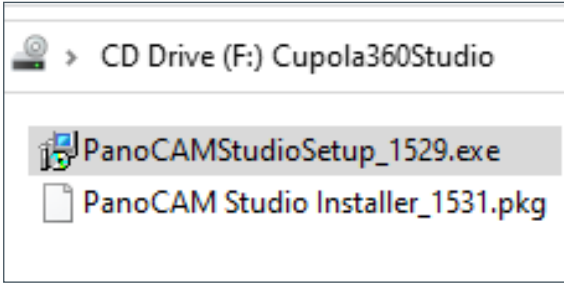
Immediately after you connect the UNITE 180 to a computer,

On a Windows-based computer...	On a Mac OS based computer...
Windows displays the software’s .exe file as if it was on a drive:	Mac OS displays the following icon on your desktop:
 <p>Note: Your computer’s Windows settings may not display this window automatically. In that case, from within Windows, navigate to My PC (or This PC), to view your computer’s drives.</p>	

For detailed instructions about installation and use of the PanoCAMStudio (Cupola360Studio) software, see the [UNITE 180 User Manual](#).

Troubleshooting

Problem	Resolution
The Image jitters	Check stability of the location: Remove vibrating objects
The image flashes	Eliminate unstable lighting.

Free Manuals Download Website

<http://myh66.com>

<http://usermanuals.us>

<http://www.somanuals.com>

<http://www.4manuals.cc>

<http://www.manual-lib.com>

<http://www.404manual.com>

<http://www.luxmanual.com>

<http://aubethermostatmanual.com>

Golf course search by state

<http://golfingnear.com>

Email search by domain

<http://emailbydomain.com>

Auto manuals search

<http://auto.somanuals.com>

TV manuals search

<http://tv.somanuals.com>