

COSORI®



User Manual

VeSync Aeroblaze™ Indoor Grill

Model Line: CAG-A601S

Models: CAG-A601S-KUS, CAG-A601S-KUSR



Questions or Concerns?

Mon-Fri, 9:00 am-5:00 pm PST/PDT
support@cosori.com | (888) 402-1684



Thank you for your purchase!



(We hope you love your new indoor grill as much as we do)



join

the Cosori Cooks Community on Facebook
[facebook.com/groups/cosoricooks](https://www.facebook.com/groups/cosoricooks)



explore

our recipe gallery
www.cosori.com/recipes



enjoy

weekly, featured recipes
made exclusively by our in-house chefs



CONTACT OUR CHEFS

Our helpful, in-house chefs are ready to assist you with any questions you might have!

Email: recipes@cosori.com

Toll-Free: (888) 402-1684

Mon–Fri, 9:00 am–5:00 pm PST/PDT

On behalf of all of us at Cosori,

Happy cooking!

Table of Contents

Package Contents	3
Specifications	3
Important Safeguards	4
Getting to Know Your Indoor Grill	7
Display	8
Controls	9
Before First Use	11
• Setting Up	11
• Test Run	11
• VeSync App Setup	12
Cooking with Your Indoor Grill	13
• Using the Accessories	13
• Splatter Guard Assembly	14
• Oil Collector Assembly	14
• Cooking Functions	15
• VeSync App Functions	17
• Preheat Function (“PREHEAT”)	18
• Crisp Function (“CRISP”)	19
• Broil Function (“BROIL”)	20
• Roast Function (“ROAST”)	21
• Bake Function (“BAKE”)	22
• Air Grill Function (“AIR GRILL”)	23
• Dehydrate Function (“DEHYDRATE”)	24
• Shaking Food	25
Accessories	26
Care & Maintenance	26
Troubleshooting	29
VeSync App Troubleshooting	31
Warranty Information	33
Customer Support	34

Package Contents

1 x	Aeroblaze Indoor Grill
1 x	Smoke Filter (Pre-Installed)
1 x	Cooking Pot
1 x	Grill Grate
1 x	Basket
1 x	Cleaning Brush
1 x	Recipe Book
1 x	Quick Reference Guide
1 x	User Manual

Specifications

Power Supply	AC 120V, 60Hz
Rated Power	1750 W
Capacity	6 qt / 5.7 L (Cooking Pot)
	4 qt / 3.7 L (Basket)
Temperature Range	105°–510°F / 40°–265°C
Time Range	1 min–12 hr
Weight	19.6 lb / 8.9 kg
Dimensions	13.7 x 16.2 x 10.4 in / 34.7 x 41.2 x 26.5 cm

VeSync App

To get the most out of your indoor grill and access smart functions, download the free VeSync app.

Scan the QR code or search “VeSync” in the Apple App Store® or Google Play Store.



For app setup instructions, see page 12.

READ AND SAVE THESE INSTRUCTIONS

IMPORTANT SAFEGUARDS

Follow basic safety precautions when using your indoor grill.

Read all instructions.

Key Safety Points

- **Do not** touch hot surfaces. To open, use handle and a heat-resistant glove or oven mitt to avoid touching the surface of the grill.
- The outside of the grill, including the lid, is hot during and after use.
- **Always** use heat-resistant gloves, pads, or oven mitts when handling hot materials, and when placing items in or removing items from the grill, including accessories or containers.
- **Do not** block any ventilation openings. Keep hands and face clear of vents at all times.
- **Do not** use third-party replacement parts or accessories, as this may cause injuries.
- **Do not** use outdoors.
- **Do not** place the grill or any of its parts on a stove, near gas or electric burners, or inside a heated oven.
- Be extremely cautious when removing a tray or basket if it contains hot oil, grease, or other hot liquids.
- **Do not** clean with metal scouring pads. Metal fragments can break off the pad and touch electrical parts, creating a risk of electric shock, as well as damage ceramic coating on accessories.

General Safety

- When the grill is not in use, and before cleaning, press  to turn it off, then unplug from outlet. Allow to cool completely before putting on or taking off parts.
- **Do not** immerse the housing, cord, or plug in water or liquid.
- Closely supervise children near the grill.
- **Do not** use your grill if it is damaged, not working, or if the cord or plug is damaged. Contact **Customer Support** (see page 34).
- Clean the cooking pot after using. Accumulated grease and crumbs can overheat and catch fire.
- **Do not** store anything on top of your grill while it is operating. **Do not** store anything inside your grill other than recommended accessories.
- **Do not** operate with a separate remote-control system.
- **Only** use as directed in this manual.
- Not for commercial use. Household use **only**.

- This grill is not intended for use by persons (including children) with reduced physical, sensory, or mental capabilities, or lack of experience and knowledge, unless they have been given supervision or instruction concerning use of the grill by a person responsible for their safety.
- Supervise children when they are near the grill.
- Children should not clean or perform maintenance on the grill without supervision.

While Cooking

- An indoor grill works with hot air **only**. **Never** fill the cooking pot with oil or fat.
- **Do not** place oversized foods or metal utensils (except for Cosori accessories) into your grill.
- **Do not** place paper, cardboard, or non-heat-resistant plastic into your grill, or any materials which may catch fire or melt.
- To avoid overheating, **do not** use metal foil in the grill unless directed. Use extreme caution when using foil, and **always** fit foil as securely as possible. If the foil contacts the grill's splatter guard or heating element, this can cause overheating and risk of fire.
- **Never** put baking or parchment paper into the grill without food on top. Air circulation can cause paper to move and touch the splatter guard or heating element.
- **Always** use heat-safe containers. Be extremely cautious if using containers that aren't metal or glass.
- Keep your grill away from flammable materials (curtains, tablecloths, walls, etc.). Use on a flat, stable, heat-resistant surface away from heat sources or liquids.
- Immediately turn off and unplug your grill if you see dark smoke coming out. White smoke is normal, caused by heating fat or food splashing, but dark smoke means that food is burning or there is a circuit problem. Wait for smoke to clear before opening the lid. If the cause was not burnt food, contact **Customer Support**. (see page 34)
- **Do not** leave your grill unattended while in use.

Power & Cord

- Your grill has a polarized plug (one prong is wider than the other), which fits into a polarized outlet only one way. If the plug does not fit, reverse the plug. If it still does not fit, **do not** use the plug in that outlet. **Do not** alter the plug in any way.
- **Do not** let the power cord (or any extension cord) hang over the edge of a table or counter, or touch hot surfaces.
- Your grill should **only** be used with **120V, 60Hz** electrical systems. **Do not** plug into another type of outlet.
- If the power supply cord is damaged, it must be replaced by Arovast Corporation or similarly qualified persons in order to avoid an electric or fire hazard. Please contact Customer Support (page 34).
- Unplugging the power cord will disable remote control of the grill and temporarily disconnect the grill from VeSync and other third-party apps.

Electromagnetic Fields (EMF)

This indoor grill complies with all standards regarding electromagnetic fields (EMF). If handled properly and according to the instructions in this user manual, the appliance is safe to use based on scientific evidence available today.

**SAVE THESE
INSTRUCTIONS**

GETTING TO KNOW YOUR INDOOR GRILL

Your Cosori Indoor Grill uses rapid 360° air circulation technology to cook with little-to-no oil for crispy, delicious food with up to 85% less fat than traditionally deep-fried foods. With 6 convenient cooking functions, and ceramic-coated accessories, the Cosori Indoor Grill is the star of your kitchen.

Indoor Grill Diagram

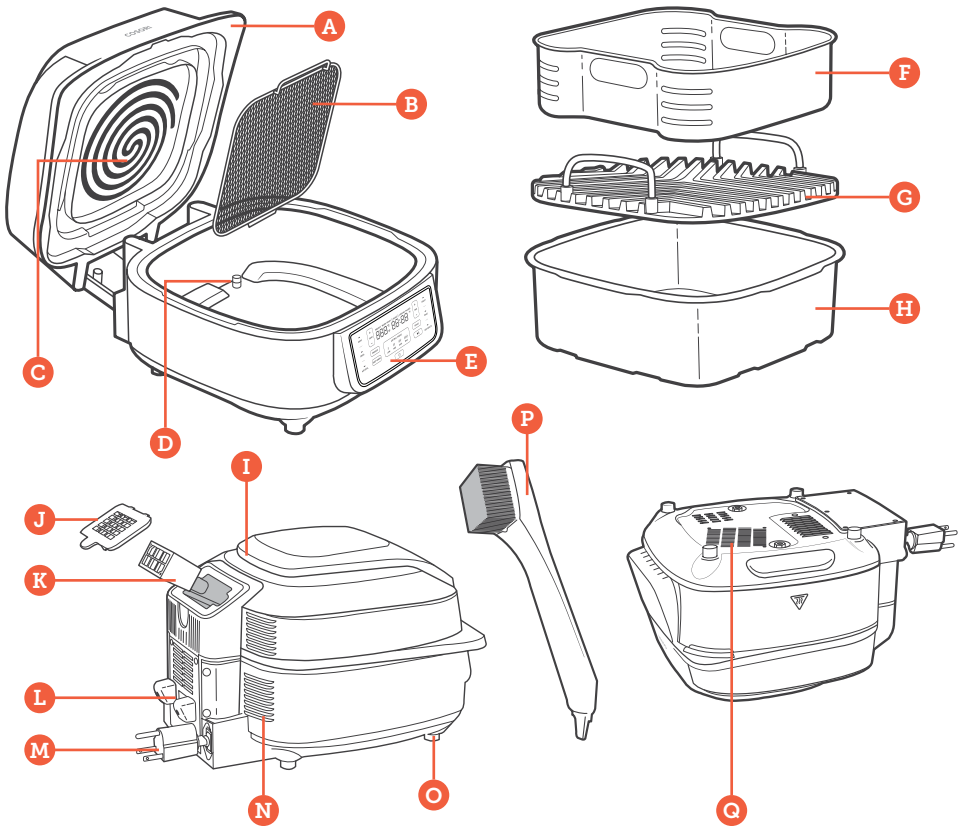

- | | | |
|---------------------------------|----------------------------|-----------------------------|
| A. Top Handle | G. Grill Grate | M. Power Cord |
| B. Splatter Guard | H. Cooking Pot | N. Lower Air Outlet |
| C. Heating Element | I. Upper Air Intake | O. Feet |
| D. Cooking Pot Interlock | J. Filter Cover | P. Cleaning Brush |
| E. Control Panel | K. Smoke Filter | Q. Bottom Air Intake |
| F. Basket | L. Oil Collector | |

DISPLAY

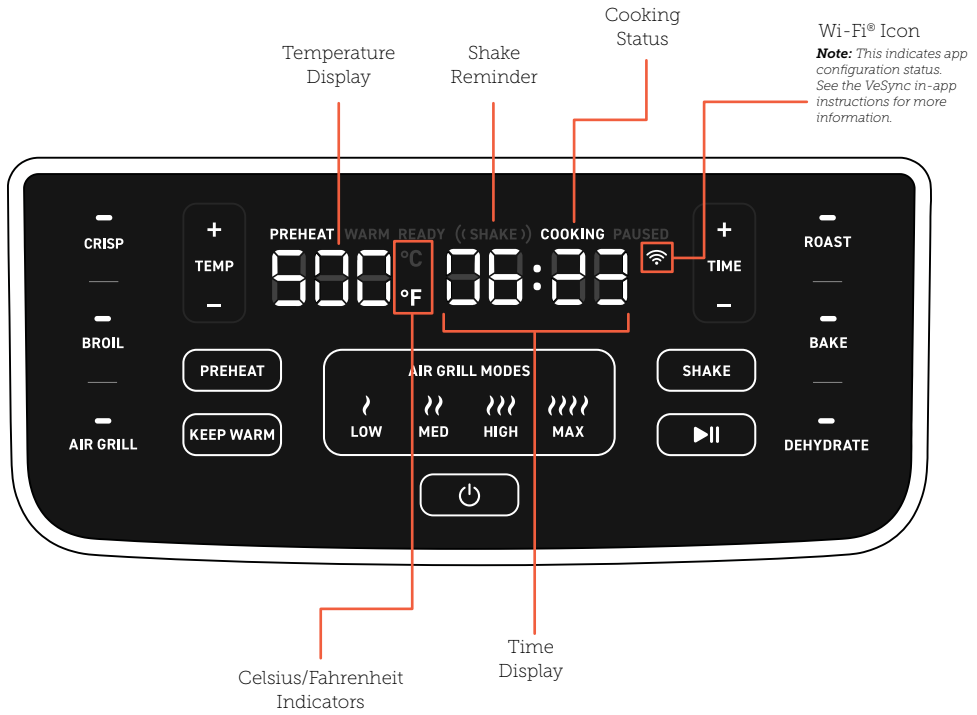

CONTROLS

Power Button

- Press to turn the grill on/off.
- While the grill is cooking or paused, press to cancel cooking. The grill will return to standby.
- Press and hold for 5 seconds to pair with the VeSync app. See the VeSync in-app instructions for more information. (see page 12)
- Press and hold for 15 seconds to reset the grill to factory settings. This will disconnect the grill from Wi-Fi®, remove the grill from the VeSync app, and restore all default cooking function settings.

START/PAUSE Button

- Press to start or stop a cooking function.
- Press to resume cooking after pausing.

SHAKE Button

- Press to add or remove a Shake Reminder.
- The Shake Reminder will appear halfway through the remaining cooking time. The grill will beep, and "(SHAKE)" will blink on the display. This will repeat every 60 seconds and turn off after 2 minutes if there is no activity.
- The Shake Reminder will also stop blinking and beeping if you open the lid to flip food.
- The Shake Reminder cannot be added to the Dehydrate function.
- For more information on shaking, see **Shaking Food** (page 25).

TIME Button

- Press + or - to adjust cooking time.
- Time will adjust in increments of +/- 5 minutes.

TEMP Button

- Press + or - to adjust temperature in increments of +/- 5°F.
- Press and hold to adjust in increments of +/- 15°F.
- Press and hold both + and - for 5 seconds to switch between Fahrenheit and Celsius.

AIR GRILL Button

- Press to select the Air Grill function.
- Press repeatedly to cycle through heat settings.

PREHEAT Button

- Press to add or remove preheat before cooking.
- Preheat cannot be used with the Dehydrate function.
- Preheat time is calculated automatically.

KEEP WARM Button

- Press before or during cooking to select the Keep Warm function.
- If selected, Keep Warm function will begin after cooking time is over.
- Keep Warm function defaults to 140°F for 5 minutes and can only be adjusted on the VeSync app.
- Keep Warm cannot be added to the Dehydrate function.

Cooking Functions

Crisp	Air Grill (Low, Medium, High, Max)	Roast	Broil	Bake	Dehydrate	Preheat	Keep Warm
-------	---------------------------------------	-------	-------	------	-----------	---------	-----------

Time Increment Chart

Crisp, Broil, Roast, Bake		
Below 60 minutes	Press once	+/- 1-minute increments
	Press and hold	+/- 15-minute increments
1–2 hours	Press or press and hold	+/- 15-minute increments
Dehydrate		
Below 60 minutes	Press once	+/- 5-minute increments
	Press and hold	+/- 30-minute increments
1–2 hours	Press or press and hold	+/- 30-minute increments

Temperature Increment Chart

Crisp, Broil, Roast, Bake, Air Grill (Low, Medium, High, Max), Dehydrate	Temperature Increment
Press once	+/- 5-minute increments
Press and hold	+/- 15-minute increments

Note:

- If the grill is inactive for 10 minutes, it will turn off automatically.
- When you open the lid during cooking (such as to shake food), the grill will pause cooking automatically. When you close the lid, the grill will resume cooking.
- When the grill is plugged in and turned off, it will remember its previous settings.

BEFORE FIRST USE

Setting Up

1. Remove all packaging around and inside the grill, including any temporary stickers.
2. Place on a stable, level, heat-resistant surface, away from anything that can be damaged by steam or heat (such as walls or cupboards).

Note: Leave 7 inches / 18 cm of space behind and 8 in / 20 cm of space above the grill. [Figure 1.1]

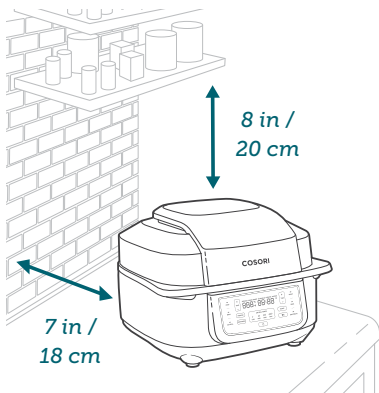

Figure 1.1

3. Wash the basket, cooking pot, and grill grate thoroughly, using either a dishwasher or a non-abrasive sponge.
4. Wipe the inside and outside of the grill with a slightly moist cloth. Dry with a towel.
5. Wipe the outside surface of the smoke filter. Dry with a towel.

Note: Do not wash the smoke filter.

Test Run

A test run will help you become familiar with your grill, make sure it's working correctly, and clean it of possible residues.

1. Make sure there is no food or packaging in the grill and plug it in.
2. Place the splash guard on the underside of the lid, below the heating element.
3. Place the cooking pot in the base, then place the grill grate on top of the cooking pot.
4. Remove the filter cover and slide the filter into the back of the grill with the pull tabs facing outward. Replace the filter cover. [Figure 1.2]
5. Press **POWER**, then press **MAX**.
6. Press **START/PAUSE** to begin heating. The **START/PAUSE** button will light up, and the display will show the timer counting down.
7. The grill will stop heating and beep several times when finished.

Note:

- You may notice a slight smell during this process. This is normal for a new grill.
- The outside of the grill will be hot during and after use. To open, use handle and a heat-resistant glove or oven mitt to avoid touching the surface of the grill.

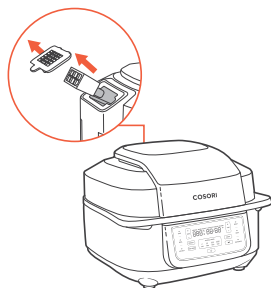

Figure 1.2

VeSync App Setup

Note: Due to ongoing updates and improvements, the VeSync app may be slightly different than shown in the manual. In case of any differences, follow the in-app instructions.

1. To download the VeSync app, scan the QR code or search “VeSync” in the Apple App Store® or Google Play Store.

Note: For Android™ users, choose “Allow” to use VeSync.



2. Open the VeSync app. If you already have an account, tap **Log In**. To create a new account, tap **Sign Up**.

Note: You must create your own VeSync account to use third-party services and products. These will not work with a guest account. With a VeSync account, you can also allow your family and friends to control your grill.

3. Turn on Bluetooth® on your phone.
4. Tap **+** in the VeSync app and select your grill.
5. Follow the in-app instructions to finish setting up your grill.

Note:

- You can change the name and icon at any time by going to the grill screen and tapping .
- You can use the VeSync app to connect your grill to Amazon Alexa or Google Assistant™.

Disconnecting From Wi-Fi:

- To disconnect Wi-Fi, press and hold the  button for 15 seconds until the Wi-Fi indicator turns off. This will restore the grill’s default settings and disconnect it from the VeSync app.
- To reconnect, please follow the instructions in the VeSync app for adding a device.

COOKING WITH YOUR INDOOR GRILL

Note: You can use the VeSync app to control your indoor grill, follow in-app recipes, and more. (see page 17).

CAUTION:

- The outer surface of the grill, including the lid, is hot during and after use. Temperature may be over 212°F / 100°C. **Do not** touch hot surfaces. Use handle.
- **Always** use heat-resistant gloves, pads, or oven mitts when handling hot materials, and when placing items in or removing items from the grill.
- **Do not** fill the cooking pot with liquid or fat. This may cause damage to the grill.
- To avoid excess smoke, use oils such as grapeseed, canola, or vegetable oil. Oils with a lower smoking point, such as olive oil, will produce more smoke during cooking.

Using the Accessories

There are 3 accessories included with your grill: the cooking pot, basket, and grill grate. The cooking functions require different accessories, so make sure to use the correct accessory. Follow the recipe instructions or the suggestions given in each function section.

Always make sure the cooking pot is properly in place at the bottom of the grill before cooking. [Figure 2.1] The cooking pot is not intended to be used to place food on.

When cooking, **do not** cook with the grill grate and the basket inserted at the same time.

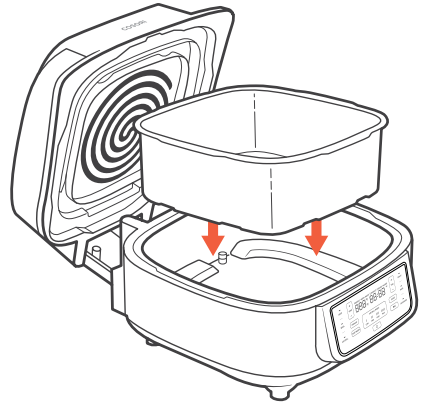

Figure 2.1

Splatter Guard Assembly

1. Insert the notches on the splatter guard into the slots on the underside of the grill lid. [Figure 2.2]
2. Use one or both thumbs to gently push the handle of the splatter guard into place.

Note: Before cooking, make sure that the splatter guard is securely in place. If the splatter guard falls out, it may interfere with cooking. Use caution when removing the splatter guard, as it may be very hot.

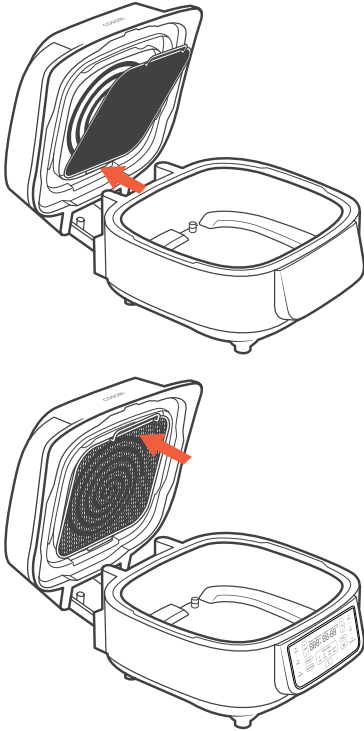

Figure 2.2

Oil Collector Assembly

1. Align the oil collector with the slot on the back of the unit. [Figure 2.3]
2. Gently push the oil collector into place.

Note: Make sure that the oil collector is securely in place before cooking.

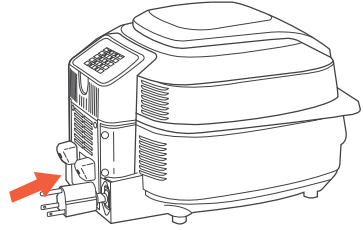

Figure 2.3

Cooking Functions

Cooking functions are programmed with an ideal time and temperature for cooking certain foods. For more information on each cooking function, see its individual section, or the **Cooking Functions Quick Reference Chart**.

Customizing Cooking Functions

- You can customize a cooking function's default settings, including time and temperature.
- To change a function's default settings:
 1. When the grill is not cooking or is paused, use the controls to choose the settings you want to change for a function button. You can choose the time, temperature, Preheat setting, Keep Warm setting, and Shake setting.
 2. Press and hold the function button for 3 seconds until the grill beeps 1 time.
- To reset a function to its original default settings:
 1. Make sure the grill is not cooking or is paused.
 2. Without making any changes, press and hold the function button for 8 seconds total.
 3. The grill will beep once after 3 seconds, and then again after 5 more seconds to indicate the temperature and time settings returning to their defaults.

Note:

- You can also customize and reset functions using the VeSync app.
- Press and hold the **PREHEAT** and **SHAKE** button to reset all functions to their default settings.

Cooking Functions Quick Reference Chart

Name	Use	Suggested Accessory	Range
Air Grill (Low)	<ul style="list-style-type: none">• Grill setting using lowest heat setting and lowest amount of air flow• Best used for foods that cook through quickly, such as fish, shrimp, vegetables, fruits, and thin-cut chicken breasts	Grill grate	Temp: 400°–445°F / 205°–230°C Time: 1 min–30 min
Air Grill (Med)	<ul style="list-style-type: none">• Grill setting using medium-high heat and medium-high air flow• Best used for foods that need moderate amounts of time, like burgers, steaks, or pork chops	Grill grate	Temp: 450°–495°F / 235°–255°C Time: 1 min–30 min

Air Grill (High)	<ul style="list-style-type: none"> • Grill setting using high heat and high air flow • Best used for searing meat 	Grill grate	Temp: 500°–505°F / 260°–262°C Time: 1 min–30 min
Air Grill (Max)	<ul style="list-style-type: none"> • Grill setting using highest heat and highest air flow • Best used to achieve grill marks on seared meats and other foods 	Grill grate	Temp: 510°F / 265°C Time: 1 min–30 min
Crisp	<ul style="list-style-type: none"> • Cooks using high heat and high air flow • Best used for crispy foods, such as chicken wings, fries, or bacon 	Basket	Temp: 300°–450°F / 150°–230°C Time: 1 min–60 min
Broil	<ul style="list-style-type: none"> • Focuses high heat on top of food • Best for melting cheeses, cooking sausages, vegetables, and browning the tops of foods 	Basket	Temp: 150°–500°F / 65°–260°C Time: 1 min–4 hr
Roast	<ul style="list-style-type: none"> • Cooks using low to high heat and even airflow to cook food thoroughly • Best used for large or tougher cuts of meats, larger vegetables, and potatoes 	Basket	Temp: 250°–500°F / 120°–260°C Time: 1 min–4 hr
Bake	<ul style="list-style-type: none"> • Cooks food evenly using low to medium heat • Best used for breads, cakes, muffins, pies, and cookies 	Basket	Temp: 250°–400°F / 120°–205°C Time: 1 min–4 hr
Dehydrate	<ul style="list-style-type: none"> • Dries food out over a longer period of time using airflow and low heat • Great for drying out herbs, fruit, or making beef jerky 	Basket	Temp: 105°–195°F / 40°–90°C Time: 1 min–12 hr

VeSync App Functions

The VeSync app allows you to access additional smart functions, including those listed below.

Remote Control

- All grill functions can be controlled remotely (except for starting cooking, for safety reasons).
- Cooking progress can be monitored from a distance.

Keep Warm

- Adjust the time and temperature for the Keep Warm function before you begin cooking.

In-App Cosori Recipes

- Pre-programmed recipes made by Cosori's in-house chefs are available in the app. Selecting a recipe automatically sets the recommended time and temperature.
- Create and save custom recipes.

Doneness Control

- Pre-programmed doneness controlled through the VeSync app helps you achieve perfect results.
- Access a variety of doneness levels for proteins such as beef, pork, and fish.

Custom Cooking Programs

- Multiple presets can be combined to make customized cooking programs for multi-phase cooking.



Third-Party Voice Control

- Compatible with Amazon Alexa and Google Assistant™ for voice commands.
 - Connect your grill to the VeSync app.
 - Tap **More** in the VeSync app.
 - Follow the in-app instructions to connect to a third-party service and set up voice control.

Note: The VeSync app is continually updated and app features will expand.

Preheat Function (“PREHEAT”)



We recommend preheating before placing food inside the grill, unless your grill is already hot. Food will not cook thoroughly without preheating.

1. Plug in. Press  to turn on the grill.
2. Select a cooking preset. The **PREHEAT** function will light up automatically.
3. Optionally, bypass preheating by pressing the **PREHEAT** button.
 - a. If you’ve deselected the Preheat function, place food in the basket before pressing . Press  to start cooking. The display will light up to indicate that your food is cooking.
4. Preheat time is calculated automatically.
 - a. The Preheat function cannot be used with the Dehydrate function.

Crisp Function (“CRISP”)



This function is ideal for cooking a variety of food, including French fries and chicken wings. Uses high heat and airflow.

1. Place the cooking pot into the base of the grill, followed by the basket.
2. Close the lid, press , then press **CRISP**.
3. Optionally, customize the temperature and time.
 - a. Press **TEMP** to control temperature. Use **+/-** to adjust the temperature between 300°–450°F / 150°–230°C.
 - b. Press **TIME** to control time. Use **+/-** to adjust the time between 1 min–60 min.
 - c. If you would like to bypass preheating, press **PREHEAT** to deselect the preheat function.
4. Optionally select **SHAKE** to add a Shake Reminder.
 - a. If selected, the Shake Reminder will remind you to flip your food halfway through cooking. The grill will beep and **SHAKE** will flash on the display.
 - b. Press  to resume cooking after flipping your food.
 - c. Be extremely careful when flipping food, as it may be very hot. Use oven mitts or heat-resistant gloves, as well as tongs or other utensils, to flip your food.
5. Optionally, select **KEEP WARM** to have the Keep Warm function turn on after your food is done cooking.
 - a. Customize temperature and time settings for Keep Warm in the VeSync app while food is warming or cooking is paused.
6. Press  to start cooking.
7. When preheating is complete, the grill will beep and **READY** will flash on the display.
8. Carefully lift the lid using the handle while wearing oven mitts or heat-resistant gloves and place food into the grill. The grill will automatically pause heating while the lid is open.
 - a. **Do not** overfill the basket.
 - b. For best results, add food up to one-third of the basket's capacity.
9. Close the lid and resume cooking. The display will light up to indicate that your food is cooking.
10. When cooking is done, the grill will beep and **END** will show on the display. Carefully remove food and leave the lid open so that the grill can cool.

Broil Function (“BROIL”)





This function focuses heat on the tops of foods, including cheeses, sausages, and vegetables. Uses high heat.

1. Place the cooking pot into the base of the grill, followed by the basket.
2. Close the lid, press **⏻**, then press **BROIL**.
3. Optionally, customize the temperature and time.
 - a. Press **TEMP** to control temperature. Use **+/-** to adjust the temperature between 150°–500°F / 65°–260°C.
 - b. Press **TIME** control time. Use **+/-** to adjust the time between 1 min–4 hr.
 - c. If you would like to bypass preheating, press **PREHEAT** to deselect the preheat function.
4. Optionally select **SHAKE** to add a Shake Reminder.
 - a. If selected, the Shake Reminder will remind you to flip your food halfway through cooking. The grill will beep and **SHAKE** will flash on the display.
 - b. Press **▶||** to resume cooking after flipping your food.
 - c. Be extremely careful when flipping food, as it may be very hot. Use oven mitts or heat-resistant gloves, as well as tongs or other utensils, to flip your food.
5. Optionally, select **KEEP WARM** to have the Keep Warm function turn on after your food is done cooking.
 - a. Customize temperature and time settings for Keep Warm in the VeSync app while food is warming or cooking is paused.
6. Press **▶||** to start cooking.
7. When preheating is complete, the grill will beep and **READY** will flash on the display.
8. Carefully lift the lid using the handle wearing oven mitts or heat-resistant gloves and place food into the grill. The grill will automatically pause heating while the lid is open.
 - a. **Do not** overfill the basket.
 - b. For best results, add food up to one-third of the basket's capacity.
9. Close the lid and resume cooking. The display will light up to indicate that your food is cooking.
10. When cooking is done, the grill will beep and **END** will show on the display. Carefully remove food and leave the lid open so that the grill can cool.

Roast Function (“ROAST”)



This function cooks food thoroughly and is best used for large or tougher cuts of meats and larger vegetables. Uses low to high heat and even airflow.

1. Place the cooking pot into the base of the grill, followed by the basket.
2. Close the lid, press , then press **ROAST**.
3. Optionally, customize the temperature and time.
 - a. Press **TEMP** to control temperature. Use **+/-** to adjust the temperature between 250°–500°F / 120°–260°C.
 - b. Press **TIME** to control time. Use **+/-** to adjust the time between 1 min–4 hr.
 - c. If you would like to bypass preheating, press **PREHEAT** to deselect the preheat function.
4. Optionally select **SHAKE** to add a Shake Reminder.
 - a. If selected, the Shake Reminder will remind you to flip your food halfway through cooking. The grill will beep and **SHAKE** will flash on the display.
 - b. Press  to resume cooking after flipping your food.
 - c. Be extremely careful when flipping food, as it may be very hot. Use oven mitts or heat-resistant gloves, as well as tongs or other utensils, to flip your food.
5. Optionally, select **KEEP WARM** to have the Keep Warm function turn on after your food is done cooking.
 - a. Customize temperature and time settings for Keep Warm in the VeSync app while food is warming or cooking is paused.
6. Press  to start cooking.
7. When preheating is complete, the grill will beep and **READY** will flash on the display.
8. Carefully lift the lid using the handle while wearing oven mitts or heat-resistant gloves and place food into the grill. The grill will automatically pause heating while the lid is open.
 - a. **Do not** overfill the basket.
 - b. For best results, add food up to one-third of the basket's capacity.
9. Close the lid and resume cooking. The display will light up to indicate that your food is cooking.
10. When cooking is done, the grill will beep and **END** will show on the display. Carefully remove food and leave the lid open so that the grill can cool.

Bake Function (“BAKE”)



This function is ideal for making breads, cakes, muffins, pies, and cookies. Uses low to medium heat to cook food evenly.

1. Place the cooking pot into the base of the grill, followed by the basket.
2. Close the lid, press **⏻**, then press **BAKE**.
3. Optionally, customize the temperature and time.
 - a. Press **TEMP** to control temperature. Use **+/-** to adjust the temperature between 150°–400°F / 120°–205°C.
 - b. Press **TIME** to control time. Use **+/-** to adjust the time between 1 min–4 hr.
 - c. If you would like to bypass preheating, press **PREHEAT** to deselect the preheat function.
4. Optionally select **SHAKE** to add a Shake Reminder.
 - a. If selected, the Shake Reminder will remind you to flip your food halfway through cooking. The grill will beep and **SHAKE** will flash on the display.
 - b. Press **▶||** to resume cooking after flipping your food.
 - c. Be extremely careful when flipping food, as it may be very hot. Use oven mitts or heat-resistant gloves, as well as tongs or other utensils, to flip your food.
5. Optionally, select **KEEP WARM** to have the Keep Warm function turn on after your food is done cooking.
 - a. Customize temperature and time settings for Keep Warm in the VeSync app while food is warming or cooking is paused.
6. Press **▶||** to start cooking.
7. When preheating is complete, the grill will beep and **READY** will flash on the display.
8. Carefully lift the lid using the handle while wearing oven mitts or heat-resistant gloves and place food into the grill. The grill will automatically pause heating while the lid is open.
 - a. **Do not** overfill the basket.
 - b. For best results, add food up to one-third of the basket's capacity.
9. Close the lid and resume cooking. The display will light up to indicate that your food is cooking.
10. When cooking is done, the grill will beep and **END** will show on the display. Carefully remove food and leave the lid open so that the grill can cool.

Air Grill Function (“AIR GRILL”)



This function is ideal for cooking open-faced sandwiches, thin cuts of meat (such as bacon), poultry, fish, sausages, and vegetables.

Can also be used to brown the tops of casseroles, gratins, and desserts.

1. Place the cooking pot into the base of the grill, followed by the grill grate.
2. Close the lid, press **⏻**, then press **AIR GRILL** or directly select the Low, Medium, High, or Max heat setting.
3. Optionally, customize the temperature and time.
 - a. Press **TEMP** to control temperature. Use **+/-** to adjust the temperature according to the range for your selected heat setting.
 - b. Press **TIME** to control time. Use **+/-** to adjust the time between 1 min–30 min.
 - c. If you would like to bypass preheating, press **PREHEAT** to deselect the preheat function.
 - d. Save custom settings by pressing and holding **AIR GRILL** for 3 seconds.
 - e. Reset to the default function settings by pressing and holding **AIR GRILL** for 8 seconds.
4. Optionally select **SHAKE** to add a Shake Reminder.
 - a. If selected, the Shake Reminder will remind you to flip your food halfway through cooking. The grill will beep and **SHAKE** will flash on the display.
5. Press **▶||** to resume cooking after flipping your food.
6. Be extremely careful when flipping food, as it may be very hot. Use oven mitts or heat-resistant gloves, as well as tongs or other utensils, to flip your food.
7. Optionally, select **KEEP WARM** to have the Keep Warm function turn on after your food is done cooking.
 - a. Customize temperature and time settings for Keep Warm in the VeSync app while food is warming or cooking is paused.
8. Press **▶||** to start cooking.
9. When preheating is complete, the grill will beep and **READY** will flash on the display.
10. Carefully lift the lid using the handle while wearing oven mitts or heat-resistant gloves and place food into the grill. The grill will automatically pause heating while the lid is open.
 - a. For best results, add food in a single layer.
11. Close the lid and resume cooking. The display will light up to indicate that your food is cooking.
12. When cooking is done, the grill will beep and **END** will show on the display. Carefully remove food and leave the lid open so that the grill can cool.

Dehydrate Function (“DEHYDRATE”)



This function combines low and stable heat with steady airflow to evenly dry out foods without cooking. Ideal for drying herbs, fruit, or making beef jerky.

1. Place the cooking pot into the base of the grill, followed by the basket.
2. Place food into the basket.
 - a. For best results, add food in a single layer.
3. Close the lid, press , then press **DEHYDRATE**.
 - a. Press **TEMP** to control temperature. Use **+/-** to adjust the temperature between 105°–195°F / 40°–90°C.
 - b. Press **TIME** to control time. Use **+/-** to adjust the time between 1 min–12 hr.
4. Optionally, customize the temperature and time.
5. Press **▶|** to start cooking.
6. When cooking is done, the grill will beep and **END** will show on the display. Carefully remove food and leave the lid open so that the grill can cool.

Shaking Food

Shake Reminder

- The Shake Reminder is designed to remind you to check on your food, usually to flip or mix it. Press **SHAKE** to turn on the Shake Reminder.
- You can use the Shake Reminder with any cooking function except Dehydrate. We especially recommend using the Shake Reminder with the **Crisp** function (see page 19).
- The Shake Reminder will appear halfway through cooking time.
- If **SHAKE** is pressed during cooking, it will appear halfway through the remaining cooking time.
- The Shake Reminder will alert you with a beep, and “(**SHAKE**)” will blink on the display.
- The Shake Reminder will turn off once you open the grill lid.
- The Shake Reminder will turn off after 2 minutes if there is no activity.

What to Shake

- Small foods that are stacked, such as fries or nuggets, will usually need mixing or flipping. Otherwise, this food may not be crispy or evenly cooked.
- You can flip other food, such as steak, to ensure even browning.

How to Shake

- Add the Shake Reminder to your cooking program by pressing **SHAKE**.
- When the Shake Reminder appears, carefully lift the lid using the handle wearing oven mitts or heat-resistant gloves. The grill will automatically pause heating while the lid is open.
- Use tongs or other utensils to mix or flip the food.
- When you close the lid, cooking will automatically resume.
- Avoid mixing or flipping food longer than 30 seconds, as the grill may start to cool down.

ACCESSORIES

Additional and replacement accessories are available for your indoor grill. For more information, contact **Customer Support** (see page 34).

CARE & MAINTENANCE

Clean grill accessories (including cooking pot, splatter guard, etc.) and grill interior after every use.

1. Before cleaning, turn off and unplug the grill, and allow it to cool completely. Open the lid for faster cooling.
2. Apply non-abrasive liquid cleanser or a mild spray solution to a soft, damp cloth or sponge (not the grill surface) and wipe all parts of the grill. **Do not** use a dry cloth on the display screen, or it may be scratched.
3. Clean the splatter guard using a non-abrasive liquid cleanser or a mild spray solution and soft, damp cloth or sponge.
4. To remove the oil collector for cleaning, pull the oil collector carefully from the back of the grill.

Note: *The oil and oil collector will be hot after cooking. Allow the grill to cool before cleaning the oil collector.*

5. Carefully dispose of oil, then clean the empty oil collector using a non-abrasive liquid cleanser or a mild spray solution and soft, damp cloth or sponge. Allow to dry completely before replacing into grill.

6. Remove the filter cover and take out the filter. Clean using a non-abrasive liquid cleanser or a mild spray solution and a soft, damp cloth or sponge to wipe the outer surface of the filter.

Note: *The filter and filter cover will be hot after cooking. Allow the grill to cool before cleaning the filter.*

7. Let all surfaces dry completely before plugging in or turning on the grill.

Note: *The cooking pot, basket, grill grate, and splatter guard are dishwasher safe.*

Removing the Splatter Guard

Note: The splatter guard will be hot after cooking. Allow the grill to cool before cleaning the splatter guard.

1. Brace your thumbs against the top end of the grill and insert your index fingers behind the top end of the splatter guard. [Figure 3.1]
2. Gently but firmly pull the splatter guard away from the grill.

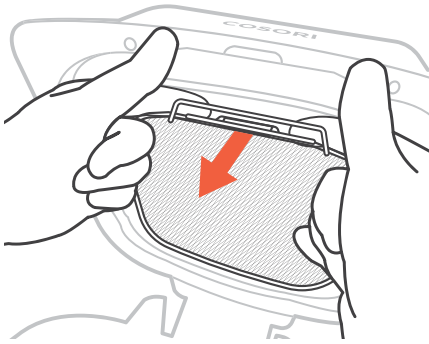

Figure 3.1

Cleaning the Splatter Guard

Clean the splatter guard after every use to prevent grease or food residue from becoming permanently stuck to the mesh.

1. Optionally, soak the splatter guard overnight to help soften grease and residues.
2. Use the cleaning brush to remove grease from the edges of the guard.

Deep Clean

Deep clean the splatter guard to remove excess grease and food residue.

1. Deep clean the splatter guard by placing it in a pot of boiling water for 10 minutes.
2. After boiling, carefully remove the splatter guard and rinse with room temperature water.
3. Allow to dry completely before using again.

Storage

1. Clean and dry the grill and all accessories.
2. Place the cooking pot into the grill.
3. Place the grill grate into the grill base, on top of the cooking pot.
4. Place the basket into the grill base, on top of the grill grate, with the handles on the right and left of the grill. [Figure 3.2] All accessories should be stacked on top of one another.
5. Close the lid.
6. Store the grill in an upright position. **Do not** store anything on top.

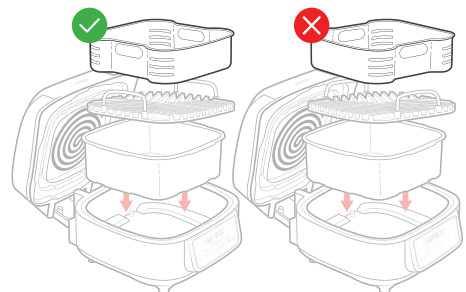

Figure 3.2

Replacing the Filter

After a period of use, the lights over the **CRISP** and **ROAST** buttons will flash and "Replace Filter" will show on the display to indicate that the filter needs to be replaced.

1. Open the grill lid or press any button to stop the indicators.
2. Remove the filter cover and remove the filter from the back of the grill.
3. Insert a new filter into the back of the grill with the pull tabs facing outward. Replace the filter cover.
4. Press and hold the **CRISP** and **ROAST** buttons at the same time for 5 seconds. The grill will beep and "Reset Done" will appear on the display.

Note: *The grill will still operate when the filter needs to be replaced, but will not capture smoke or odors as effectively. For best results, replace the filter every 6 months or after approximately 60 uses.*

TROUBLESHOOTING

Problem	Possible Solution
The grill will not turn on.	Make sure the grill is plugged in.
The grill has a plastic smell.	New grills may have a plastic smell. This is normal. Follow the instructions for a Test Run to get rid of the plastic smell (page 11).
Food is not completely cooked.	Increase cooking temperature or time.
	Place smaller batches of food into the grill.
Food is overcooked or burned.	Decrease cooking temperature or time.
	Make sure food items are not too large and are not touching the heating element.
Food is cooked unevenly.	Preheat the grill manually by using the Preheat function (page 18).
	Make sure food items are not too closely packed into the grill. We recommend filling the grill to one-third of its capacity.
	Spread food into an even layer before cooking
	Use the Shake Reminder and mix or flip food halfway through cooking (see Shaking Food , page 25).
Food is not crispy after grilling.	Spraying or brushing a small amount of oil on foods prior to cooking can increase crispiness.
White smoke or steam is coming out of the grill.	The grill may produce some white smoke or steam during cooking. This is normal.
	During first use, dust from the packing process may cause white smoke. This is normal for air grills and many other kitchen appliances. To eliminate any dust, see Test Run (page 11).
	Excess oil or fatty foods may produce white smoke. Make sure the inside of the grill is cleaned properly and isn't greasy.
	The filter may need to be replaced. We recommend replacing the filter every 6 months (or approximately every 60 uses). Contact Customer Support (see page 34).
	Using fats or oils with a low smoking point such as coconut, olive, or vegetable oil, may produce white smoke during cooking.
Dark smoke is coming out of the grill.	Immediately press ► and unplug your grill. Food is burning. Wait for smoke to clear before opening the lid.

Problem	Possible Solution
A thermometer shows that the grill temperature is different from the grill setting.	Commonly used thermometers usually have low sensitivity and take over 10 minutes to measure the correct temperature. This will not affect cooking.
Display shows Error Code "E1".	There is an open circuit in the temperature monitor. Contact Customer Support (see page 34).
Display shows Error Code "E2".	There is a short circuit in the temperature monitor. Contact Customer Support (see page 34).
Display shows Error Code "E3".	The grill is overheating. Unplug it and allow it to cool down.
Display shows Error Code "E4" or "E5".	Make sure your grill is being used with the correct 120V, 60Hz electrical system, or contact Customer Support (see page 34).

If your problem is not listed, please contact **Customer Support** (see page 34).

VESYNC APP TROUBLESHOOTING

Why isn't my grill connecting to the VeSync app?

- During the setup process, you must be on a secure 2.4 GHz Wi-Fi® network. Confirm that the network is working correctly.
- Make sure the Wi-Fi password you entered is correct.
- Turn on Bluetooth® on your phone (for Android™ users, make sure Location is turned on as well).
- Make sure your grill and phone are within 30 ft / 10 m of each other.
- Reset the grill by pressing and holding  for 15 seconds, then try connecting again.

My grill is offline.

- Make sure the grill is plugged in. The grill may appear to be offline if it is unplugged, or if the outlet does not have power.
- Refresh the VeSync menu by swiping down on the screen.
- Make sure your router is connected to the internet and your phone's network connection is working.
- Delete the grill from the VeSync app. Swipe left (iOS®) or tap and hold (Android), and tap **Delete**. Then reconfigure your grill with the VeSync app.

Note: Power outages, internet outages, or changing Wi-Fi routers may cause your grill to go offline.

If your problem is not listed, please contact **Customer Support** (see page 34).

Attributions

Apple App Store® is a trademark of Apple Inc.

Google, Android, and Google Play are trademarks of Google LLC.

Wi-Fi® is a registered trademark of Wi-Fi Alliance®.

Amazon, Alexa, and all related logos are trademarks of Amazon.com, Inc. or its affiliates.

iOS is a registered trademark of Cisco Systems, Inc. and/or its affiliates in the United States and certain other countries.

The Bluetooth® word mark and logos are registered trademarks owned by Bluetooth SIG, Inc. and any use of such marks by Arovast Corporation is under license. Other trademarks and trade names are those of their respective owners.

FCC STATEMENT- PART 15

This device complies with Part 15 of the FCC Rules. Operation is subject to the following two conditions:

1. This device may not cause harmful interference, and
2. This device must accept any interference received, including interference that may cause undesired operation.

NOTE: This equipment has been tested and found to comply with the limits for a Class B digital device, pursuant to Part 15 of the FCC Rules. These limits are designed to provide reasonable protection against harmful interference in a residential installation. This equipment generates, uses and can radiate radio frequency energy and, if not installed and used in accordance with the instructions, may cause harmful interference to radio communications. However, there is no guarantee that interference will not occur in a particular installation. If this equipment does cause harmful interference to radio or television reception, which can be determined by turning the equipment off and on, the user is encouraged to try to correct the interference by one or more of the following measures:

- Reorient or relocate the receiving antenna.
- Increase the separation between the equipment and receiver.
- Connect the equipment into an outlet on a circuit different from that to which the receiver is connected.
- Consult the dealer or an experienced radio/TV technician for help.

FCC Caution: Any changes or modifications not expressly approved by the party responsible for compliance could void the user's authority to operate this equipment.

FCC RADIATION EXPOSURE STATEMENT

This equipment complies with FCC radiation exposure limits set forth for an uncontrolled environment. End users must follow the specific operating instructions for satisfying RF exposure compliance. To maintain compliance with FCC RF exposure compliance requirements, please follow operation instructions as documented in this manual. This transmitter must not be co-located or operating in conjunction with any other antenna or transmitter. This equipment should be installed and operated with a minimum distance of 20 cm between the radiator and your body. The availability of some specific channels and/or operational frequency bands are country dependent and are firmware programmed at the factory to match the intended destination. The firmware setting is not accessible by the end user.

WARRANTY INFORMATION

Product	<i>Cosori VeSync Aeroblaze Indoor Grill</i>
Models	<i>CAG-A601S-KUS, CAG-A601S-KUSR</i>
For your own reference, we strongly recommend that you record your order ID and date of purchase.	
Order ID	
Date of Purchase	

TERMS & POLICY

Arovast Corporation (“Arovast”) warrants this product to the original purchaser to be free from defects in material and workmanship, under normal use and conditions, for a period of 2 years from the date of original purchase.

Arovast agrees, at our option during the warranty period, to repair any defect in material or workmanship or furnish an equal product in exchange without charge, subject to verification of the defect or malfunction and proof of the date of purchase.

There is no other express warranty. This warranty does not apply:

- If the product has been modified from its original condition;
- If the product has not been used in accordance with directions and instructions in the user manual;
- To damages or defects caused by accident, abuse, misuse or improper or inadequate maintenance;
- To damages or defects caused by service or repair of the product performed by an unauthorized service provider or by anyone other than Arovast;
- To damages or defects occurring during commercial use, rental use, or any use for which the product is not intended;
- To damages or defects exceeding the cost of the product.

Arovast will not be liable for indirect, incidental, or consequential damages in connection with the use of the product covered by this warranty.

This warranty extends only to the original consumer purchaser of the product and is not transferable to any subsequent owner of the product regardless of whether the product is transferred during the specified term of the warranty.

This warranty does not extend to products purchased from unauthorized sellers. Arovast’s warranty extends only to products purchased from authorized sellers that are subject to Arovast’s quality controls and have agreed to follow its quality controls.

All implied warranties are limited to the period of this limited warranty.

This warranty gives you specific legal rights and you may also have other rights which vary from state to state. Some states do not allow the exclusion or limitation of incidental or consequential damages, so the above limitation or exclusion may not apply to you.

If you discover that your product is defective within the specified warranty period, please contact Customer Support via support@cosori.com. **DO NOT** dispose of your product before contacting us. Once our Customer Support Team has approved your request, please return the product with a copy of the invoice and order ID.

Every Cosori product automatically includes a 2-year warranty. To make the customer support process quick and easy, register your product online at www.cosori.com/warranty.

This warranty is made by:

Arovast Corporation
1202 N. Miller St., Suite A
Anaheim, CA 92806

CUSTOMER SUPPORT

If you have any questions or concerns about your new product, please contact our helpful Customer Support Team.

Arovast Corporation

1202 N. Miller St., Suite A
Anaheim, CA 92806

Email: support@cosori.com

Toll-Free: (888) 402-1684

Support Hours

Mon – Fri, 9:00 am – 5:00 pm PST/PDT

** Please have your invoice and order ID ready before contacting Customer Support.*

SHOW US WHAT YOU'RE MAKING

We hope this has been helpful to you. We can't wait to see your beautiful results, and we think you'll want to share glam shots! Our community awaits your uploads—just pick your platform of choice below. Snap, tag, and hashtag away, Cosori chef!

#LiveLifeTastefully #iCookCosori

@CosoriCooks



@Cosori



MORE COSORI RECIPES

Considering *what* to cook? Many recipe ideas are available, both from us and the Cosori community.

COSORI®

Questions or Concerns?

Mon–Fri, 9:00 am–5:00 pm PST/PDT
support@cosori.com | (888) 402-1684

Free Manuals Download Website

<http://myh66.com>

<http://usermanuals.us>

<http://www.somanuals.com>

<http://www.4manuals.cc>

<http://www.manual-lib.com>

<http://www.404manual.com>

<http://www.luxmanual.com>

<http://aubethermostatmanual.com>

Golf course search by state

<http://golfingnear.com>

Email search by domain

<http://emailbydomain.com>

Auto manuals search

<http://auto.somanuals.com>

TV manuals search

<http://tv.somanuals.com>