

User Manual



Floor Fryers



351FFOP40N, 351FFOP40L, 351FFOP50N, 351FFOP50L



REVISED 11/2021

Congratulations on your purchase of Cooking Performance Group commercial cooking equipment! At Cooking Performance Group, we take pride in the design, innovation, and quality of our products. To ensure optimal performance, we have outlined the following instructions and guidelines in this manual carefully for your review. Cooking Performance Group declines any responsibility in the event users do not follow the instructions or guidelines stated here.

Contents

Safety Precautions	3
Gas Pressure	3
Start-Up	4–8
Operating Instructions	9–10
Cooking Hints	10
Cleaning & Maintenance	11–12
Service	12–14
Troubleshooting	15
Wiring Diagram	16
Warranty	17

Product Overview

CPG floor fryers feature an open pot design that makes heat transfer reliable and efficient for optimal performance. Range match to your CPG ranges for equal operating heights for a nice even flow in the kitchen. These models are made from stainless steel to maximize the fryers durability and lifecycle. Along with that, the CPG open pot design creates an easy and safe cleaning process that will help save time in your kitchen. These units have a reduced cold zone which creates for a more efficient output and maximizes the frying capacity. CPG floor fryers come with (4) 6" adjustable legs for stability. Featuring 40lb & 50lb models in both natural gas and liquid propane, CPG fryers are a versatile asset for your commercial kitchen.

Safety Precautions

CAUTION:

- Failure to comply with the following operation instructions could lead to potential hazards and/or unsafe practice and could result in injury and damage to product and property.

NOTICE:

- Local codes regarding installation vary greatly from one area to another. The National Fire Protection Association, Inc., states in its NFPA96 latest edition that Local codes are “Authority Having Jurisdiction” when it comes to requirement for installation of equipment. Therefore, installation should comply with all Local codes.
- This product is intended for commercial use only. Not for residential use.

WARNING:

- Do not store or use gasoline or other flammable vapors and liquids in the vicinity of this or any other equipment.
- Improper installation, adjustment, alteration, service or maintenance could lead to property damage, injury or death. Read the installation, operating and maintenance instructions thoroughly before installing or servicing CPG equipment. This manual must be retained for future reference.
- A factory authorized agent must handle all maintenance and repair.

Gas Pressure

- The appliance and its individual shutoff valve (to be supplied by user) must be disconnected from the gas supply piping system during any pressure testing of that system at test pressures in excess of ½ PSI (3.45 kPa).
- The appliance must be isolated from the gas supply piping system by closing its individual manual shut-off valve during any pressure testing of the gas supply piping system at test pressures equal to or less than ½ PSI (3.45 kPa).

Start-Up

INSTALLATION

THESE UNITS ARE SUITABLE FOR INSTALLATION ON NON-COMBUSTIBLE SURFACES ONLY.
DO NOT INSTALL NEAR ANY COMBUSTIBLE SURFACES.

UNPACK

Immediately inspect for shipping damage. All containers should be examined for damage before and during unloading. The freight carrier has assumed responsibility for sale transit and delivery. If damaged equipment is received, either apparent or concealed, a claim must be made with the delivering carrier.

Apparent damage or loss must be noted on the freight bill at the time of delivery. The freight bill must then be signed by the carrier representative (Driver). If the bill is not signed, the carrier may refuse the claim. The carrier can supply the necessary forms.

A request for inspection must be made to the carrier within 15 days if there is concealed damage or loss that is not apparent until after the equipment is uncrated. The carrier should arrange an inspection. Be certain to hold all contents and all packing materials.

1. Uncrate carefully. Report any hidden damage to the freight carrier IMMEDIATELY.
2. Do not remove any tags or labels until the unit is installed and working properly.

All propane (LP) gas fryers MUST HAVE an appliance regulator installed in addition to the tank or stage regulator. If propane fryer is installed without the correct pressure regulator, parts will be damaged and the warranty will be void.

The appliance regulator must be set to gas pressure between 11"WC and 12"WC.

NOTE: There is a pressure regulator "built in" to the combination gas valve. If the incoming pressure is at 10"WC or lower, this "built in" regulator will act as a restriction and cause incomplete combustion and sooting. If the gas pressure is above 12"WC, damage could occur to the "built in" pressure regulator and in that case, it would have to be replaced. This would not be covered by the warranty.

INSTALL THE LEGS (OR OPTIONAL CASTERS & RESTRAINTS)

A set of legs or casters is packed with the fryer. Mounting fasteners are pre-mounted on the baseplates.

1. Raise fryer sufficiently to allow legs or casters to be screwed into the baseplate. For safety, "shore up" and support the fryer with an adequate blocking arrangement strong enough to support the load.
2. Screw the four legs or casters to the plate on the bottom of the fryer. When casters have been ordered, the casters having a locking-brake should be attached under the front of the fryer.
3. Lower the fryer gently. Never drop or allow the fryer to fall.

4. Use a level to make sure that the fryer is level. Each caster, or the tubular-end of each leg, can be screwed in or out to lower or raise each corner of the fryer.
5. Attach restraints as required by local codes.

FLUE INSTALLATION

1. Unpack the flue box and flue wrap.



2. Slide the flue box over the flue and secure it with the two self-tapping screws using a 5/16" socket.



3. Slide the flue wrap over the flue.



4. Secure it with four self-tapping screws two on the back and one on each side using a 5/16" socket.



CHECK CLEARANCES & VENTILATION

Select a firm, level location for your fryer. Leave clearance, whenever possible, so that access from the rear is possible to permit cleaning. If the unit is to be set on non-combustible flooring such as a concrete slab, 3 inches minimum toe room must be provided to prevent restriction of the air opening in the bottom of the unit.

WARNING:

There must be adequate clearance between fryer(s) and construction. Clearance must also be provided in front for servicing and for operation.

Minimum clearances from combustible construction:

Sides: 6" Rear: 6"

All CPG Floor Fryers shall be installed with at least a 16" space between the fryer and surface flames from adjacent equipment.

Suitable for installation on combustible floors. No additional side and rear clearance is required for service as the fryer is serviceable from the front.

WARNING:

Improper ventilation can result in personal injury or death. Ventilation that fails to properly remove flue products can cause headaches, drowsiness, nausea, or could result in death.

Unit must be installed under a ventilation hood.

All units must be installed in such a manner that the flow of combustion and ventilation air is not obstructed. Provisions for adequate air supply must also be provided. DO NOT obstruct the bottom front of the unit as combustion air enters through this area. Be sure to inspect and clean the ventilation system according to the ventilation equipment manufacturer's instructions.

Due to the variety of problems that can be caused by outside weather conditions, venting by canopies or wall fans is preferred over any type of direct venting. It is recommended that a canopy extend 6" past the appliance and the bottom edge be located 6'6" from the floor. Filters should be installed at an angle of 45° or more from the horizontal. This position prevents dripping of grease and facilitates collecting the run-off grease in a drip pan, usually installed with a filter. A strong exhaust fan tends to create a vacuum in the room and may interfere with burner performance or may extinguish pilot flames. Fresh air openings approximately equal to the fan area will relieve such a vacuum. In case of unsatisfactory performance on any appliance, check the appliance with the exhaust fan in the "OFF" position. Do this only long enough to check equipment performance, then turn hood back on and let it run to remove any exhaust that may have accumulated during the test.

- The exhaust fan should be installed at least 2 feet above the vent opening at the top of the fryer.
- Make sure all ventilation meets local code requirements.
- This unit is not intended to be connected directly to an outside flue.

GAS CONNECTION

- A 3/4" male NPT line for the gas connection is located near the lower right rear corner of the fryer. The serial plate (located inside the front door of the fryer) indicates the type of gas the unit is equipped to burn (natural gas or propane). The fryer should be connected ONLY to the type of gas for which it is equipped.
- A circuit diagram is located inside the front door of the fryer.
- All CPG equipment is adjusted at the factory; however, pilot height should be checked at installation and adjusted if necessary.
- For orifice sizes and pressure regulator settings, see chart on pg. 5. If the fryer is being installed at over 2,000 feet altitude and that information was not specified when ordered, contact the appropriate authorized CPG Service Representative or the CPG Service Department. Failure to install with proper orifice sizing will result in poor performance and may void the warranty.
- If applicable, the vent line from the gas appliance pressure regulator shall be installed to the outdoors in accordance with local codes or, in the absence of local codes, with the *National Fuel Gas Code, ANSI Z223.1, Natural Gas Installation Code, CAN/CGA-B149.1, or the Propane Installation Code, CAN/CGA-B149.2*, as applicable.
- An adequate gas supply is imperative. Undersized or low pressure lines will restrict the volume of gas necessary for satisfactory performance. A combination gas valve and pressure regulator, which is provided with each unit, is set to maintain a 4"WC manifold pressure for natural gas or 10"WC manifold pressure for propane gas. However, to maintain these conditions, the pressure on the supply line, when all units are operating simultaneously, should not drop below 7"WC for natural gas or 11"WC for propane gas. Fluctuations of more than 25% on natural gas or 10% on propane gas will create problems and affect burner operating characteristics. A 1/8" tap to measure the manifold pressure is located on the combination gas valve which is on the burner manifold located directly below the burners inside the cabinet.
- Purge the supply line to clean out dust, dirt, or other foreign matter before connecting the line to the unit.
- It is recommended that an individual manual shutoff valve be installed in the gas supply line to the unit.
- Use pipe joint compound that is suitable for use with both natural and LP gas on all threaded connections.

CAUTION:

All pipe joints and connections must be tested thoroughly for gas leaks. Use only soapy water for testing on all gases. Never use an open flame to check for gas leaks. All connections must be checked for leaks after the unit has been put into operation. **Test pressure should not exceed 14"WC.**

CAUTION:

This appliance and its individual combination gas valve must be disconnected from the gas supply piping system during any pressure testing of that system at test pressures in excess of 14"WC (1/2 PSIG or 3.45 kPa). If the incoming gas pressure is in excess of 14"WC (1/2 PSI, 3.45 kPa), a proper step-down regulator will be required. See photo 1 for LP application.

- Connect the gas supply directly to the 3/4" male NPT connector located near the lower left rear corner of the fryer. When tightening the supply pipe, be sure to hold the mating connector extending from the unit securely with a wrench. This will prevent any damage or distortion to the internal piping and controls of the unit.

WARNING:

Checking for gas leaks: Using a gas leak detector or a soapy water solution is recommended for locating gas leaks. Matches, candle flame, or other sources of ignition shall not be used for this purpose. Check entire piping system including the internal piping and pipe union inside of the fryer for leaks. DO NOT use an open flame to check for leaks. Check all gas piping for leaks with a soap and water solution before operating the unit.

- After connecting the gas supply, check again that the fryer is level. Use a long spirit level four ways; across the front and rear of the fry pot and along each edge.

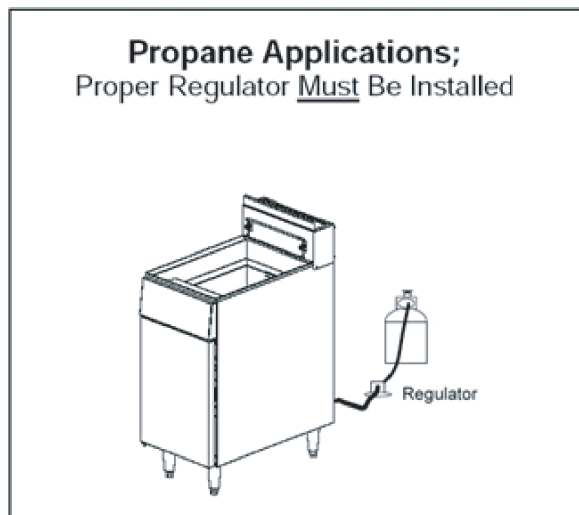

NOTICE:

Do not restrict the flow of gas. Use only commercially approved gas appliance connectors OR flexible hoses. Non-commercial connectors or flexible hoses will void your warranty.

Operating Instructions

LIGHTING INSTRUCTIONS

CAUTION:

If you smell gas during the lighting procedure, immediately shut off the gas supply until the leak has been corrected.

Open the burner compartment door and do the following:

1. Turn thermostat to “OFF” by aligning the “OFF” with the red indicator.
2. Press down the knob of the combination gas valve, turn it counterclockwise to the “PILOT” position (shown), and continue to press the knob down.
3. While pressing the knob down, use a lit match to ignite the pilot. Continue to press the knob down for about 30 seconds. If the pilot does not stay lit when the knob is released, repeat the lighting procedure and keep the knob down longer. Adjustment of pilot flame may be necessary.
4. When the pilot stays lit, turn the knob counterclockwise to the “ON” position. DO NOT press down on the knob in this step.
5. DO NOT turn the thermostat “ON” until the fry pot is filled with oil or solid shortening.
6. Once the fry pot is filled with shortening, set the thermostat to the desired temperature.

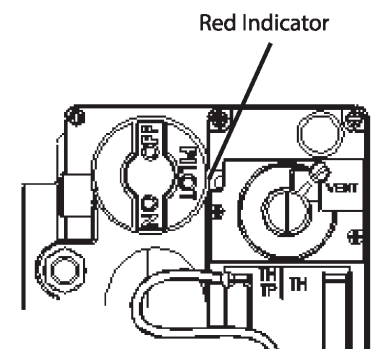

FILLING THE FRY POT

1. Close drain valve completely before filling the fry pot.
2. When the fryer is new, fill the fry pot with water and clean thoroughly (see “Weekly Cleaning” on pg. 11) in order to remove protective coatings and any foreign matter.
3. The recommended solid shortening capacity for the fry pot (35 lbs. or 55 lbs.) is described on the serial plate (which is located inside the front door).
4. Remove the basket support frame when filling the fry pot with solid shortening.
5. When solid shortening is used, be careful not to bend, break, or twist the thin capillary wires of the sensing elements located in the fry pot.
6. Pack solid shortening into the zone below the tubes, all spaces between the tubes, and at least an inch above the top of the tubes before lighting the fryer. If any air spaces are left around the heat tube surfaces when the heat is turned on, the tube surfaces will become red hot, burn the solid shortening, weaken the fry pot, and could result in fire.

CAUTION:

Never attempt to melt a solid block of shortening on the top of the heat tubes. Never start the burners when the fry pot is empty.

7. To prevent burning or scorching the solid shortening, keep the thermostat set at the lowest temperature until all the solid shortening between and above the tubes has been melted. Additional solid shortening can then be added until the desired frying depth has been reached.
8. Replace the basket support frame over the fry pot heat tubes.

SHUTDOWN PROCEDURE

Standby: Turn knob on the combination gas valve to the “PILOT” position. At this setting, only the pilot burner will remain ignited.

Complete Shutdown: Turn knob on the combination gas valve clockwise, press down on the knob and continue to turn to the “OFF” position.

RELIGHTING

WARNING:

In the event of a main burner ignition failure, a five minute purge period must be observed prior to reestablishing the ignition source.

1. Shut off all gas.
2. Wait five minutes.
3. Follow the “Lighting” procedure as described on pg. 9.

AUTOMATIC PILOT VALVE

The automatic pilot valve provides an automatic safety shutoff for the fryer when the pilot flame is extinguished. When the pilot flame is burning, the valve is held open electromagnetically by the electrical current from a thermopile in the pilot flame. When the pilot flame goes out, generation of current ceases and the valve closes automatically.

HIGH LIMIT CONTROL

CPG Floor Fryers are equipped with a secondary heat control that prevents the oil temperature from rising above 450°F (Because of the accuracy tolerance of the sensor, the oil temperature may reach as high as 475°F).

In the event the fryer shuts down due to this condition, the oil must be cooled to below 400°F before the pilot burner can be re-ignited. When the oil has cooled, use the “Lighting” procedure on pg. 9 to restore functionality. If the problem persists, contact your CPG Service Representative or the CPG Service Department.

Cooking Hints

USER TIPS

- Smoking oil means that the temperature is too high or that the oil has broken down.
- Gum in fry pot denotes a need for thorough cleaning (see “Weekly Cleaning” on pg. 11).
- Use different oil for oily foods (mackerel, nutmeg, etc.) than for foods with water-soluble flavors (potatoes, onions, etc.).
- Taste oil for quality. Replace it regularly.
- Poor oil cannot produce good food.

Cleaning & Maintenance

Regular cleaning and maintenance will maintain the appearance and performance of your fryer for years to come. Follow these tips to keep your fryer operating at its best.

WARNING:

BURN HAZARD. If necessary to move the fryer for cleaning, etc., drain oil first to avoid death or serious injury, If disconnection of the restraint is necessary to move the appliance for cleaning, etc., reconnect it when the appliance is moved to its originally installed position.

CAUTION:

Some areas of the fry pot may be hot!

DAILY:

1. Turn thermostat knob to “OFF” position.
2. Place hot oil-safe container under the drain and drain the fry pot completely,
3. Remove the basket support frame (if applicable) and flush out any sediment remaining in the fry pot with a little hot oil.
4. Wipe off the basket support frame and the inside of the fry pot with a clean cloth.
5. Close drain valve and strain the oil back into the fry pot through several thicknesses of cheesecloth, or filter it back using a filter machine.
6. Replace the basket support frame (if applicable).
7. Add oil or shortening to “MIN” oil level mark on rear of fry pot.
8. To resume cooking, turn the combination gas valve knob to “ON” position.

WEEKLY:

1. Follow steps 1 through 4 of the Daily cleaning procedure (see previous section).
2. Close drain valve and fill fry pot with a solution of warm water and boil-out compound.
3. Relight the fryer and bring the solution to gentle boil for at least five minutes.
4. Turn off main burners and let the solution stand until the gum deposits are softened and the carbon spots and burned grease spots can be rubbed off.
5. Scrub the fry pot walls and heat tubes, then drain out fry pot and rinse it with clean water.
6. Refill the fry pot with clean water and boil again.
7. Turn off gas and drain and rinse well until clean.
8. Wipe dry with a clean cloth.
9. Refill as specified in the “Filling the Fry Pot” section (see pg. 9).

MONTHLY:

1. Perform the Weekly cleaning procedure (see previous section).
2. Clean around burner and orifices if lint has accumulated.
3. Visually check that burner carry-over ports are unobstructed.

CLEANING STAINLESS STEEL SURFACES:

1. To remove normal dirt, grease, and product residue from stainless steel, use ordinary soap and water (with or without detergent) applied with a sponge or cloth. Dry thoroughly with a clean cloth. Never use vinegar or any corrosive cleaner.

2. To remove grease and food splatter or condensed vapors that have baked on the equipment, apply cleanser to a damp cloth or sponge and rub cleanser on the metal in the direction of the polishing lines on the metal. Rubbing cleanser, as gently as possible, in the direction of the polished lines will not mar the finish of the stainless steel. NEVER RUB WITH A CIRCULAR MOTION. Soil and burnt deposits that do not respond to the above procedure can usually be removed by rubbing the surface with a scouring pad. DO NOT USE ORDINARY STEEL WOOL, as any particles left on the surface will rust and further spoil the appearance of the finish. NEVER USE A WIRE BRUSH, STEEL SCOURING PADS (EXCEPT STAINLESS), SCRAPER, FILE, OR OTHER STEEL TOOLS. Surfaces that are marred collect more dirt more rapidly and become more difficult to clean. Marring also increases the possibility of corrosion. Refinishing may then be required.
3. Darkened areas, called “heat tint,” sometimes appear on stainless steel surfaces where the area has been subjected to excessive heat. These darkened areas are caused by thickening of the protective surface of the stainless steel and are not harmful. Heat tint can normally be removed by the above cleaning techniques, but tint which does not respond to that procedure calls for a vigorous scouring in the direction of the polish lines using a scouring pad in combination with a powdered cleanser. Heat tint action may be lessened by not applying or by reducing heat to equipment during slack periods.

Service

FOR AUTHORIZED SERVICE TECHNICIANS ONLY!

NOTICE:

Warranty will be void and the manufacturer is relieved of all liability if:

- A) Service work is performed by anyone other than a qualified technician.
- B) Other than approved CPG replacement parts are installed.

WARNING:

Adjustments and service work may be performed only by a qualified technician who is experienced in and knowledgeable with the operation of commercial gas cooking equipment. However, to ensure your confidence, contact your CPG Service Representative for liable service, dependable advice or other assistance, and for genuine factory parts.

All units are adjusted at the factory. In case of problems in operation at initial installation, check type of gas and manifold pressure and compare with information listed on the serial plate.

A mill voltage circuit diagram is located inside the front door of the fryer.

CHECKING & ADJUSTING MAIN BURNERS

The main burners should burn with a steady blue flame and the inner cone of the flame from each port should be about 3/4" long. The flame from each main burner should enter each heat tube without touching the front of the fry pot or the sides, top, or bottom of each tube.



Yellow Tips
(too little air or too much gas)

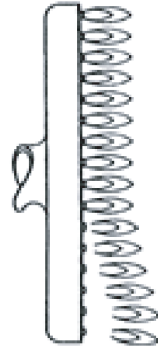

Blowing or Lifting Tips
(too much air)

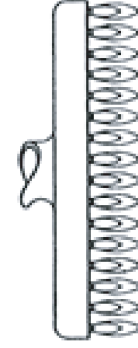

Normal Flame

CHECKING & ADJUSTING PRESSURE REGULATOR

The combination gas valve (includes pressure regulator) is factory set at 4"WC for natural gas and 10"WC for propane gas. To check the manifold pressure, do the following:

1. Turn thermostat "OFF" and combination gas valve knob to the "PILOT" setting.
2. Remove pressure tap plug from burner manifold located directly below the burners in the cabinet.
3. Install a fitting appropriate to connect a manometer.
4. Turn combination gas valve to "ON" position and thermostat to "ON." The burners will ignite. Be certain that sufficient oil is covering the tubes.
5. With burners on, read manometer.
6. If the manometer does not read 4"WC for natural gas or 10"WC for propane gas, adjust the regulator.
7. Remove regulator adjustment screw cap.
8. With small screwdriver, rotate adjustment screw clockwise to increase or counterclockwise to decrease pressure. Be sure to adjust with burners "ON."
9. Turn thermostat "OFF" and set combination gas valve knob to "PILOT" position.
10. Remove manometer and replace pressure tap plug.
11. Replace adjustment screw cap.

CHECKING & ADJUSTING CALIBRATION OF THERMOSTAT

All the thermostat controls are carefully calibrated at the factory (i.e., the dial is properly set to control appliance temperatures accurately). Only a qualified appliance service technician should perform this adjustment.

1. To check appliance temperatures, use a thermocouple-type temperature test instrument or reliable thermometer. Place the thermocouple test instrument or thermometer in the center of the fry pot.
2. Turn the control dial to the temperature setting requiring the greatest accuracy. Allow enough time for temperature to stabilize or until several temperature readings are identical.
3. Recalibrate if setting and actual temperature differ by more than 10°F.
4. Remove dial from dial shaft "B." Be careful that dial shaft does not rotate in either direction (which would change the dial setting).
5. Hold dial shaft "B" steady and with a screwdriver turn calibration screw "A" clockwise to decrease the temperature or counterclockwise to increase the temperature.
6. Replace dial. Let the appliance operate until the temperature has stabilized before final check is made to determine whether or not the calibration has been corrected.
7. Once correct, seal the calibration screw with glyptol.

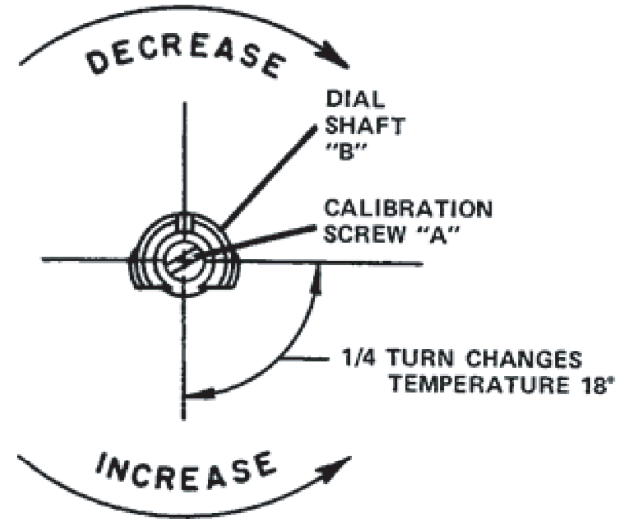

CHECKING & ADJUSTING AUTO SAFETY PILOT

The pilot flame should surround the thermopile for 1/2." It must be large and sharp enough to cause the thermopile to glow a dull red or sufficient to hold the safety valve open.

1. Remove pilot adjustment cap.

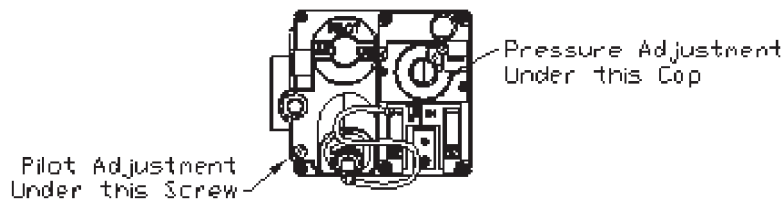

2. Adjust pilot key to provide properly sized flame as shown in diagram B. Diagram A shows improperly adjusted pilot.



3. Release pilot adjustment cap.

Troubleshooting

SYMPTOM	CAUSES	SOLUTIONS
Burners do not come on	<ol style="list-style-type: none"> 1. Gas supply to unit is off 2. Combination gas valve is in "OFF" or "PILOT" position 3. Pilot not ignited 4. Thermostat not "ON" 	<ol style="list-style-type: none"> 1. Turn on gas supply for the unit. 2. Follow the lighting instructions on pg. 9. 3. Re-ignite the pilot. 4. Turn thermostat "ON."
Pilot will not stay ignited	<ol style="list-style-type: none"> 1. Pilot gas not adjusted properly 2. Gas supply to unit is off 3. Bad thermopile 4. Dirty thermopile connections at combination gas valve or high limit 5. Clogged orifice 6. Draft condition 7. Air in gas line 	<ol style="list-style-type: none"> 1. Follow the lighting instructions on pg. 9. 2. Turn on gas supply for the unit. 3. Replace thermopile (To be installed by professional). 4. Carefully clean the thermopile connections 5. Clean or replace clogged orifice 6. Carefully move the fryer to a low draft area (Properly empty the fry pot prior to moving). 7. Contact a professional to properly fix the gas line.
Pilot produces carbon	<ol style="list-style-type: none"> 1. Unit connected to wrong gas supply 2. Pressure not adjusted correctly 3. Pilot gas not adjusted correctly 	<ol style="list-style-type: none"> 1. Connect the unit to the correct gas supply. 2. Make sure your unit has a pressure regulator installed (To be installed by a professional). 3. Follow the lighting instructions on pg. 9.
Burners produce carbon deposits	<ol style="list-style-type: none"> 1. Wrong size orifices 2. Connected to wrong gas supply 3. Pressure not adjusted correctly 4. Flue obstructed 	<ol style="list-style-type: none"> 1. Contact a professional to install the proper orifices. 2. Connect the unit to the correct gas supply. 3. Make sure your unit has a pressure regulator installed (To be installed by a professional). 4. When the unit is off and not hot, check the flue cavity for obstruction.

NOTE: Vibrations or shock caused by shaking or pounding baskets on top surface or by slamming door may cause Hi-Limit Control Switch to open. If this condition persists, additional cushioning may be added to the rubber grommets supporting this control to absorb these shocks.

Wiring Diagram

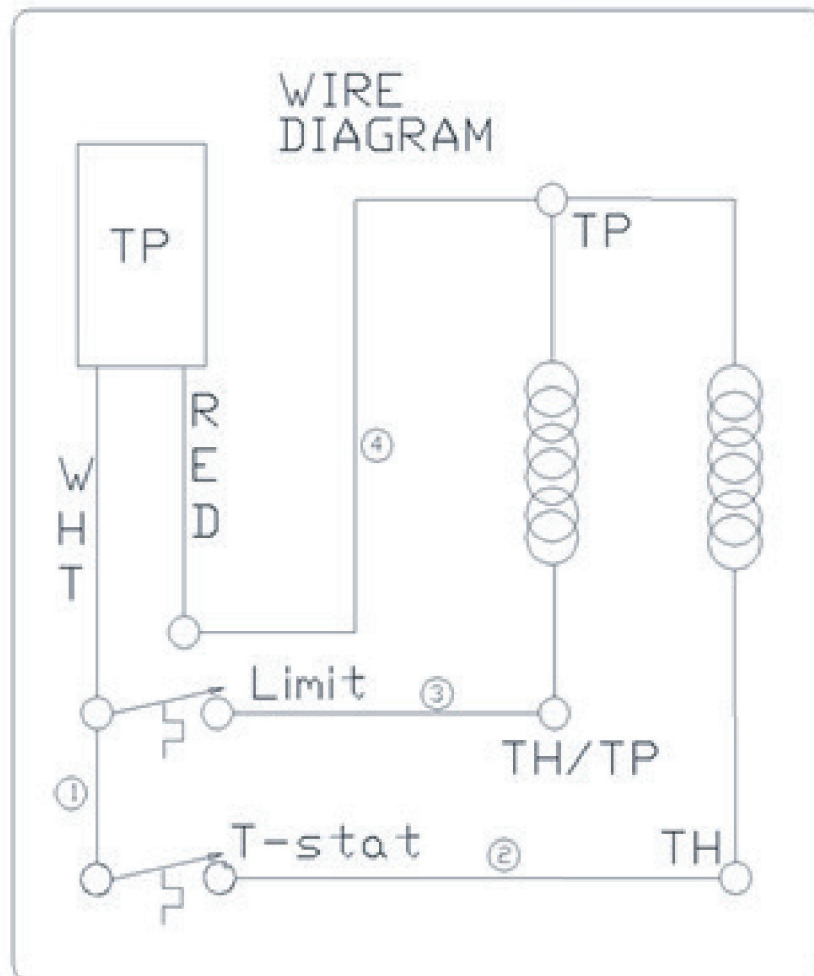

Free Manuals Download Website

<http://myh66.com>

<http://usermanuals.us>

<http://www.somanuals.com>

<http://www.4manuals.cc>

<http://www.manual-lib.com>

<http://www.404manual.com>

<http://www.luxmanual.com>

<http://aubethermostatmanual.com>

Golf course search by state

<http://golfingnear.com>

Email search by domain

<http://emailbydomain.com>

Auto manuals search

<http://auto.somanuals.com>

TV manuals search

<http://tv.somanuals.com>