

# OPERATOR'S MANUAL

## MANUAL DEL OPERADOR

# CRAFTSMAN<sup>®</sup>

40V LITHIUM-ION CORDLESS CHAIN  
40V LI-ION DE CADENA SIN CABLE

Model No.  
138.98946  
Número de modelo  
138.98946

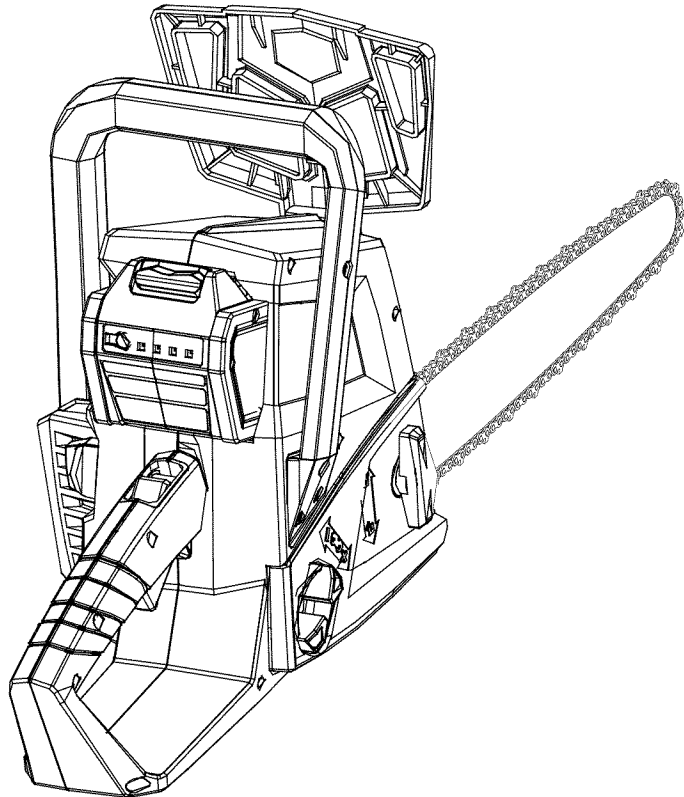

**⚠ WARNING:** To reduce the risk of injury, the user must read and understand the operator's manual before using this product.

**⚠ ADVERTENCIA:** Para reducir el riesgo de lesiones, el usuario debe leer y comprender el manual del operador antes de usar este producto.

Customer Help Line: 1-888-266-7096  
Teléfono de atención al consumidor: 1-888-266-7096

Sears, Roebuck and Co., 3333 Beverly Rd., Hoffman Estates, IL 60179 USA  
Visit the Craftsman web page: [www.sears.com/craftsman](http://www.sears.com/craftsman)  
Visite el sitio web de Craftsman: [www.sears.com/craftsman](http://www.sears.com/craftsman)

**Save this manual for future reference**  
**Guarde este manual para futuras consulta**



# TABLE OF CONTENTS / ÍNDICE DE CONTENIDO

## ENGLISH

■ Warranty.....	2
■ Introduction.....	2
■ General Safety Rules .....	3-5
■ Specific Safety Rules.....	6
■ Glossary of Terms .....	7
■ Symbols .....	8-9
■ Features .....	10
■ Assembly .....	11
■ Operation .....	11-19
■ Maintenance .....	19-25
■ Troubleshooting .....	26
■ Illustrated Parts List .....	27
■ Parts Ordering / Service.....	Back Page

## ESPAÑOL

■ Garantía .....	2
■ Introducción.....	2
■ Reglas de seguridad generales .....	3-6
■ Reglas de seguridad específicas.....	6
■ Glosario de términos.....	7
■ Símbolos .....	8-9
■ Características .....	10
■ Armado .....	11
■ Funcionamiento .....	11-19
■ Mantenimiento .....	19-25
■ Corrección de problemas .....	26
■ Pedidos de piezas / Servicio .....	Pág. posterior

### CRAFTSMAN® FOUR YEAR FULL WARRANTY

FOR FOUR YEARS from the date of purchase, this Chain Saw is warranted against any defects in material or workmanship. The battery and charger are warranted against such defects for two years from the purchase date. Defective product will be replaced free of charge.

**For warranty coverage details to obtain free replacement, visit the web site: [www.craftsman.com](http://www.craftsman.com).**

This warranty is void if this product is ever used while providing commercial services or if rented to another person. This warranty gives you specific legal rights, and you may also have other rights which vary from state to state.

**Sears Brands Management Corporation, Hoffman Estates, IL 60179**

\* \* \*

### GARANTÍA COMPLETA DE CUATRO AÑOS CRAFTSMAN®

Este podadora de setos tiene garantía por cualquier defecto en material o mano de obra DURANTE CUATRO AÑOS desde la fecha de compra. Las baterías y el cargador tienen garantía por cualquier defecto durante dos años desde la fecha de compra. Los productos defectuosos se reemplazarán sin cargo.

**Para conocer los detalles sobre la cobertura de la garantía para obtener un reemplazo gratuito, visite el sitio web: [www.craftsman.com](http://www.craftsman.com).**

La garantía pierde validez si este producto se utiliza mientras se prestan servicios comerciales o si se alquila a otra persona. Esta garantía le otorga derechos legales específicos y es posible que también tenga derechos que varían según el estado.

**Sears Brands Management Corporation, Hoffman Estates, IL 60179**

## GENERAL SAFETY RULES

**⚠ WARNING:** Read and understand all instructions. Failure to follow all instructions listed below may result in electric shock, fire, and/or serious personal injury.

### READ ALL INSTRUCTIONS

#### BASIC SAFETY PRECAUTIONS

- Do not operate a chain saw with one hand! Use a firm grip with thumbs and fingers encircling the chain saw handles. Serious injury to the operator, helpers, bystanders, or any combination of these persons may result from one-handed operation. A chain saw is intended for two-handed use.
- Always be aware of what you are doing when using the chain saw. Use common sense. Do not operate the chain saw when you are tired, ill, or under the influence of alcohol, drugs, or medication.
- Stay alert and pay attention to what you are doing. Use common sense when using this unit.
- Keep all parts of your body away from the saw chain when the unit is running.
- Always carry the chain saw by the front handle with the unit stopped and the guide bar and saw chain positioned to the rear. When transporting your chain saw, use the appropriate chain cover.
- Never let anyone use your chain saw who has not received adequate instructions in its proper use. This applies to rentals as well as privately owned saws.
- Before you start the unit, make sure the saw chain is not contacting any object.
- Stop the chain saw before setting it down. Do not leave the unit running unattended.
- To avoid accidental starting, never carry the unit with your finger on the switch trigger.
- Maintain the unit with care. Keep the cutting edge sharp and clean for best performance and to reduce the risk of injury. Follow instructions for lubricating and changing accessories. Inspect the battery charger cord periodically, and if damaged, have it replaced or repaired by an authorized service dealer.
- Keep handles dry, clean, and free of oil and grease.
- Do not operate a chain saw that is damaged, improperly adjusted, or not completely and securely assembled. Chain should stop turning when the switch trigger is released. If the chain turns after the switch trigger has been released, have the unit serviced by your nearest Craftsman service dealer.
- Check for damaged parts. Any part or guard that has been damaged should be carefully checked to determine that it will operate properly and perform its intended function. Check for alignment of moving parts, binding of moving parts, breakage of parts, mounting, and any other conditions that may affect its operation. A guard or other part that is damaged should be properly repaired or replaced by an authorized service dealer unless otherwise indicated elsewhere in this manual.
- All chain saw service, other than the items listed in the operation and maintenance sections, should be performed by your nearest Craftsman service dealer.
- Do not use in the rain, snow or wet conditions.
- Always maintain a proper stance. Do not overreach.
- Do not adapt your powerhead to a bow guide or use it to power any attachments or devices not listed for the saw.
- Do not cut vines and/or small underbrush.

---

### CALIFORNIA PROPOSITION 65

**⚠ WARNING:** This product and substances that may become airborne from its use may contain chemicals, including lead, known to the State of California to cause cancer, birth defects, or other reproductive harm. ***Wash hands after handling.***

# GENERAL SAFETY RULES

## SAFETY APPAREL

- Wear snug fitting clothing. Always wear heavy, long pants, long sleeves, overalls, jeans or chaps made of cut resistant material or ones that contain cut resistant inserts. Wear non-slip safety footwear. Wear non-slip heavy duty gloves to improve your grip and to protect your hands. Do not wear jewelry, short pants, sandals, or go barefoot. Do not wear loose fitting clothing, which could be drawn into the motor or catch the chain or underbrush. Secure hair so it is above shoulder level.
- Always wear eye protection with side shields marked to comply with ANSI Z87.1, along with head protection.

## KICKBACK

See Figures 1 - 3.

- **WARNING:** Kickback may occur when the moving chain contacts an object at the upper portion of the tip of the guide bar or when the wood closes in and pinches the saw chain in the cut. Contact at the upper portion of the tip of the guide bar can cause the chain to dig into the object and stop the chain for an instant. The result is a lightning fast, reverse reaction which kicks the guide bar up and back toward the operator. If the saw chain is pinched along the top of the guide bar, the guide bar can be driven rapidly back toward the operator. Either of these reactions can cause loss of saw control which can result in serious injury. Do not rely exclusively upon the safety devices built into the saw. As a chain saw user, you should take several steps to keep your cutting jobs free from accident or injury.
- The following precautions should be followed to minimize kickback:
  - Hold the saw firmly with both hands when the motor is running. Place your right hand on the rear handle and your left hand on the front handle with your thumbs and fingers encircling the chain saw handles. A firm grip together with a stiff left arm will help you maintain control of the saw if kickback occurs.
  - Make sure that the area in which you are cutting is free from obstructions. Do not let the nose of the guide bar contact a log, branch, fence, or any other obstruction that could be hit while you are operating the saw.
  - Always cut with the unit running at full speed. Fully squeeze the switch trigger and maintain a steady cutting speed.
  - Use replacement parts such as low kickback chain and special guide bars that reduce the risks associated with rotational kickback.
  - Use only the replacement guide bars and low kickback chains specified by the manufacturer for the saw.
- With a basic understanding of kickback, you can reduce or eliminate the element of surprise. Sudden surprise contributes to accidents.
- Keep proper footing and balance at all times.
- Do not cut above shoulder height or overreach when cutting.
- Follow the sharpening and maintenance instructions for the saw chain.

## GENERAL SAFETY RULES

- Push and Pull - This reaction force is always opposite to the direction the chain is moving where wood contact is made. Thus, the operator must be ready to control the PULL when cutting on the bottom edge of the bar, and PUSH when cutting along the top edge. See Figure 3.

### IN THE CUTTING/WORK AREA

- Do not operate a chain saw in a tree, on a ladder, rooftop or scaffold; this is extremely dangerous.
- Keep ALL children, bystanders, visitors, and animals out of the work area while starting or cutting with the chain saw.  
**NOTE:** The size of the work area depends on the job being performed as well as the size tree or work piece involved. For example, felling a tree requires a larger work area than making bucking cuts.
- Never start cutting until you have a clear work area, secure footing, and a planned retreat path from the falling tree. Cluttered area invite injuries.
- Do not expose the chain saw to rain.
- Do not use the chain saw in damp or wet locations.
- Do not use the chain saw near flammable liquids, gases, or in any type of explosive atmosphere.
- Use extreme caution when cutting small size brush and saplings, because slender material may catch the saw chain and be whipped toward you or pull you off balance.
- When cutting a limb that is under tension, be alert for spring back so that you will not be struck when the tension in the wood fibers is released.
- Do not force the chain saw. The job can be performed better and safer at the rate for which it was intended.
- Always use the right product for your application. The chain saw should be used for cutting wood only. Never use the chain saw to cut plastic, masonry or non-wood building materials.

- Do not use the chain saw for purposes not intended.
- Store idle chain saw when not in use. Chain saw should be stored in a dry and high or locked area out of the reach of children. When storing chain saw, remove battery and place the chain cover on the bar and chain.
- Remove the battery pack from the chain saw before cleaning, servicing, storing, transporting, removing material from the unit, changing accessories such as the bar and chain, or when not in use.

### UNDERSTANDING YOUR CHAIN SAW SAFETY DEVICES

#### LOW KICKBACK SAW CHAIN

The rakers (depth gauges) ahead of each cutter can minimize the force of a kickback reaction by preventing the cutters from digging in too deeply at the kickback zone. Only use replacement chain that is equivalent to original chain or has been certified as low kickback chain per ANSI B175.1.

Low kickback saw chain is chain that has met the kickback performance requirements of ANSI B175.1 - 1991 (American National Standard for Power Tools - Gasoline-Powered Chain Saws - Safety Requirements) when tested on the representative sample of chain saws below 3.8 c.i.d. specified in ANSI B175.1 - 1991.

As saw chains are sharpened during their useful life, they lose some of the low kickback qualities and extra caution should be used.

#### GUIDE BARS

Generally, guide bars with small radius tips have somewhat lower kickback potentials.

When making a replacement, be sure to order one of the Craftsman bars listed for the saw in this operator's manual.

## SPECIFIC SAFETY RULES

### BATTERY SAFETY

- Battery operated units do not have to be plugged into an electrical outlet; therefore, they are always in operating condition. Be aware of possible hazards even when unit is not operating.
- Remove the battery pack from the chain saw before cleaning, servicing, storing, transporting, removing material from the unit, changing accessories such as the bar and chain, or when not in use.
- A battery pack must be recharged only with the specified charger for the battery pack. A charger that may be suitable for one type of battery pack may create a risk of fire when used with another battery pack. Use battery pack only with charger listed.
- For use with 40 V nickel-cadmium and 40 V lithium-ion battery packs, see tool/appliance/battery pack/charger correlation supplement 988000-272.
- To reduce the risk of explosion and possible injury, Do not place battery units or their batteries near fire or heat.
- Do not open or mutilate the battery pack. Released electrolyte is corrosive and may cause damage to the eyes or skin. It may be toxic if swallowed.
- Do not crush, drop or damage battery pack. Do not use a battery pack or charger that has been dropped or received a sharp blow. A damaged battery is subject to explosion. Properly dispose of a dropped or damaged battery immediately.
- Batteries can explode in the presence of a source of ignition, such as a pilot light. To reduce the risk of serious personal injury, never use any cordless product in the presence of open flame. An exploded battery pack can propel debris and chemicals. If exposed, flush with water immediately.
- Do not charge unit in a damp or wet location. Following this rule will reduce the risk of electric shock.
- For best results, your battery unit should be charged in a location where the temperature is more than 50°F but less than 100°F. Do not store outside or in vehicles.
- Under extreme usage or temperature conditions, battery pack leakage may occur. If liquid comes in contact with your skin, wash immediately with soap and water, then neutralize with lemon juice or vinegar. If liquid gets into your eyes, flush them with clean water for at least 10 minutes, then seek immediate medical attention.
- Do not dispose of batteries in a fire. The cell may explode. Batteries should be recycled, consult your local waste authority for information regarding available recycling and/or disposal options.
- When battery pack is not in use, keep it away from other metal objects like: paper clips, coins, keys, nails, screws, or other small metal objects that can make a connection from one terminal to another. Shorting the battery pack terminals together may cause sparks, burns, or a fire.

### SAVE THESE INSTRUCTIONS

# GLOSSARY OF TERMS

## **Bar Tip Guard**

An attachment that may be provided on the end of the guide bar to prevent the chain at the end of the guide bar from contacting the wood.

## **Bucking**

The process of cross cutting a felled tree or log into lengths.

## **Chain Saw Powerhead**

A chain saw without the saw chain and guide bar.

## **Clutch**

A mechanism for connecting and disconnecting a driven member to and from a rotating source of power.

## **Drive Sprocket or Sprocket**

The toothed part that drives the saw chain.

## **Felling**

The process of cutting down a tree.

## **Felling Back Cut**

The final cut in a tree felling operation made on the opposite side of the tree from the notching undercut.

## **Front Handle**

The support handle located at or toward the front of the chain saw.

## **Front Handle Guard**

A structural barrier between the front handle of a chain saw and the guide bar, typically located close to the hand position on the front handle.

## **Guide Bar**

A solid railed structure that supports and guides the saw chain.

## **Kickback**

The backward or upward motion, or both of the guide bar occurring when the saw chain near the nose of the top area of the guide bar contacts any object such as a log or branch, or when the wood closes in and pinches the saw chain in the cut.

## **Kickback, Pinch**

The rapid pushback of the saw which can occur when the wood closes in and pinches the moving saw chain in the cut along the top of the guide bar.

## **Kickback, Rotational**

The rapid upward and backward motion of the saw which can occur when the moving saw chain near the upper portion of the tip of the guide bar contacts an object, such as a log or branch.

## **Lock-out button**

A movable stop that prevents the unintentional operation of the switch until manually actuated.

## **Low-Kickback Chain**

A chain that complies with the kickback performance requirements of ANSI B175.1-1991 when tested on a representative sample of chain saws.

## **Normal Cutting Position**

Those positions assumed in performing the bucking and felling cuts.

## **Notching Undercut**

A notch cut in a tree that directs the tree's fall.

## **Oiler Control**

A system for oiling the guide bar and saw chain.

## **Rear Handle**

The support handle located at or toward the rear of the saw.

## **Reduced Kickback Guide Bar**

A guide bar which has been demonstrated to reduce kickback significantly.

## **Replacement Saw Chain**

A chain that complies with the kickback performance requirements of ANSI B175.1-1991 when tested with specific chain saws. It may not meet the ANSI performance requirements when used with other saws.

## **Saw Chain**

A loop of chain having cutting teeth, that cut the wood, and that is driven by the motor and is supported by the guide bar.

## **Spiked Bumper (Spike)**

The pointed tooth or teeth for use when felling or bucking to pivot the saw and maintain position while sawing.

## **Switch**



A device that when operated will complete or interrupt an electrical power circuit to the motor of the chain saw.

## **Switch Linkage**









The mechanism that transmits motion from a trigger to the switch.

# SYMBOLS

The following signal words and meanings are intended to explain the levels of risk associated with this product.

SYMBOL	SIGNAL	MEANING
	<b>DANGER:</b>	Indicates an imminently hazardous situation, which, if not avoided, will result in death or serious injury.
	<b>WARNING:</b>	Indicates a potentially hazardous situation, which, if not avoided, could result in death or serious injury.
	<b>CAUTION:</b>	Indicates a potentially hazardous situation, which, if not avoided, may result in minor or moderate injury.
	<b>CAUTION:</b>	(Without Safety Alert Symbol) Indicates a situation that may result in property damage.





Some of the following symbols may be used on this product. Please study them and learn their meaning. Proper interpretation of these symbols will allow you to operate the product better and safer.

SYMBOL	NAME	DESIGNATION/EXPLANATION
	Safety Alert	Indicates a potential personal injury hazard.
	Read Operator's Manual	To reduce the risk of injury, user must read and understand operator's manual before using this product.
	Wet Conditions Alert	Do not expose to rain or use in damp locations.
	Wear Eye and Head Protection	Always wear eye protection with side shields marked to comply with ANSI Z87.1, along with head protection.
	Operate With Two Hands	Hold and operate the saw properly with both hands.
	One Handed	Do not operate the saw using only one hand.
	Kickback	DANGER! Beware of kickback.
	Bar Nose Contact	Avoid bar nose contact.
	Wear Gloves	Wear non-slip, heavy-duty protective gloves when handling the chain saw.



# SYMBOLS

Some of the following symbols may be used on this product. Please study them and learn their meaning. Proper interpretation of these symbols will allow you to operate the product better and safer.

SYMBOL	NAME	DESIGNATION/EXPLANATION
	Wear Safety Footwear	Wear non-slip safety footwear when using this equipment.
	Keep Bystanders Away	Keep all bystanders and animals at least 50 ft. away.
	Oil Indicator	Pour bar and chain lubricant into oil tank where indicated. Do not use any other fluids.
	Recycle Symbols	This product uses lithium-ion or nickel-cadmium batteries. Local, state or federal laws may prohibit disposal of batteries in ordinary trash. Consult your local waste authority for information regarding available recycling and/or disposal options.
V	Volts	Voltage
=	Direct Current	Type or a characteristic of current

# FEATURES

## PRODUCT SPECIFICATIONS

Motor .....	40 Volt DC
Bar Length .....	12 in.
Replacement Bar Part Number .....	120SDEA041
Replacement Chain Part Number .....	91P045X/91PX045X

**NOTE:** This saw was designed for occasional light duty use and has some limitations as to what it can cut.

## KNOW YOUR CHAINSAW

See figure 4.

The safe use of this product requires an understanding of the information on the product and in this operator's manual as well as a knowledge of the project you are attempting. Before use of this product, familiarize yourself with all operating features and safety rules.

## ASSEMBLY

### UNPACKING

This product has been shipped completely assembled.

- Carefully remove the product and any accessories from the box. Make sure that all items listed in the packing list are included.

**⚠ WARNING:** Do not use this product if it is not completely assembled or if any parts appear to be missing or damaged. Use of a product that is not properly and completely assembled could result in serious personal injury.

- Inspect the product carefully to make sure no breakage or damage occurred during shipping.
- Do not discard the packing material until you have carefully inspected and satisfactorily operated the product.
- If any parts are damaged or missing, please call 1-800-932-3188 for assistance.

### PACKING LIST

Chain Saw with Chain Cover  
Wrench  
Battery Pack  
Charger  
Operator's Manual

**⚠ WARNING:** If any parts are damaged or missing do not operate this product until the parts are replaced. Using the saw with damaged or missing parts could result in serious personal injury.

**⚠ WARNING:** Do not attempt to modify this product or create accessories not recommended for use with this product. Any such alteration or modification is misuse and could result in a hazardous condition leading to possible serious personal injury.

**⚠ WARNING:** To prevent accidental starting that could cause serious personal injury, always remove the battery pack from the product when assembling parts.

## OPERATION

**⚠ WARNING:** Do not allow familiarity with this product to make you careless. Remember that a careless fraction of a second is sufficient to inflict serious injury.

**⚠ WARNING:** Always wear eye protection with side shields marked to comply with ANSI Z87.1, along with head protection. Failure to do so could result in objects being thrown into your eyes and other possible serious injuries.

**⚠ WARNING:** Do not use any attachments or accessories not recommended by the manufacturer of this product. The use of attachments or accessories not recommended can result in serious personal injury.

Before each use, inspect the entire product for damaged, missing, or loose parts such as screws, nuts, bolts, caps, etc. Tighten securely all fasteners and caps and do not operate this product until all missing or damaged parts are replaced. Please call 1-800-932-3188 or contact an authorized service center for assistance.

### APPLICATIONS

You may use this product for the following purposes:

- Limbing and pruning branches from trees
- Felling small trees up to 5 in. diameter
- Bucking the fallen tree into shorter lengths

This product will accept Craftsman 40 V lithium-ion battery packs and Craftsman 40 V nickel-cadmium battery packs.

## OPERATION

For complete charging instructions, refer to the Operator's Manual for your Craftsman battery pack and charger models.

### TO INSTALL / REMOVE BATTERY PACK

See figure 5.

**⚠ WARNING:** Always remove battery pack from your tool when you are assembling parts, making adjustments, cleaning, carrying, transporting or when not in use. Removing battery pack will prevent accidental starting that could cause serious personal injury.

**NOTE:** To avoid serious personal injury, always remove the battery pack and keep hands clear of the lock-out button when carrying or transporting the tool.

#### To install:

- Place the battery pack in your chain saw. Align raised rib on battery pack with groove in chain saw's battery port.
- Make sure the latches on each side of the battery pack snap in place and that battery pack is secured in chain saw before beginning operation.

#### To remove:

Locate latches on side of battery pack and depress both sides to release the battery pack from the chain saw.

**CAUTION:** When placing battery pack in your chain saw, be sure raised rib on battery pack aligns with groove in chain saw's battery port and latches snap in place properly. Improper assembly of battery pack can cause damage to internal components.

**CAUTION:** Remove battery pack from unit. Fill oil tank with Craftsman Bar and Chain Lubricant before starting the chain saw. Failure to lubricate the chain will cause damage to the bar and chain.

### CHAIN OIL SYSTEM

See figure 6.

- Use Craftsman Bar and Chain Lubricant. It is formulated to perform over a wide temperature range with no dilution required.  
**NOTE:** Do not use dirty, used or otherwise contaminated lubricants. Damage may occur to the bar or chain.
- Carefully pour the bar and chain lubricant into the tank.
- Check and fill the oil tank when battery is recharged, or as needed.
- Depress the oil tank cap several times to pump the lubricant to the chain before starting the saw.
- Depress the oil tank cap every 20-30 seconds while cutting to keep the chain lubricated.

**NOTE:** It is normal for lubricant to seep from the saw when not in use. To prevent seepage, empty the oil tank after each use. When storing the unit for a long period of time (three months or longer) be sure the chain is lightly lubricated; this will prevent rust on the chain and bar sprocket.

# OPERATION

## STARTING AND STOPPING THE CHAIN SAW

See figure 7

**⚠ WARNING:** Keep body to the left of the chain line. Never straddle the saw or chain, or lean over past the chain line.

### Starting the chain saw:

- Place the chain saw on a flat bare surface and make sure no objects or obstructions are in immediate vicinity which could come in contact with the bar and chain.
- Press and hold the lock-out button. This makes the switch trigger operational.
- Press and hold the switch trigger, release the lock-out button and continue to squeeze the switch trigger for continued operation.

### Stopping the chain saw:

- Release the switch trigger to stop the chain saw.
- Upon release of the switch trigger, the lock-out button will be automatically reset to the lock position.

This cordless chain saw is not designed for cutting trees larger than 5 in. in diameter.

This cordless chain saw is designed for limbing and pruning type cutting, as well as cutting trees up to 5 in. in diameter only.

## PREPARATION FOR CUTTING

### PROPER GRIP ON HANDLES See figure 8-10.

Refer to *GENERAL SAFETY RULES* earlier in this manual for appropriate safety equipment.

- Wear non-slip gloves for maximum grip and protection.
- Hold the saw firmly with both hands. Always keep your left hand on the front handle and your right hand on the rear handle so that your body is to the left of the chain line.

**⚠ WARNING:** Never use a left-handed (cross-handed) grip, or any stance which would place your body or arm across the chain line.

- Maintain a proper grip on the saw whenever the unit is running. The fingers should encircle the handle and the thumb is wrapped under the handlebar. This grip is least likely to be broken (by a kickback or other sudden reaction of the saw). Any grip in which the thumb and fingers are on the same side of the handle, is dangerous because a slight kick of the saw can cause loss of control.

**⚠ WARNING:** Do not operate the switch trigger with your left hand and hold the front handle with your right hand. Never allow any part of your body to be in the chain line while operating a saw.

# OPERATION

## PROPER CUTTING STANCE

See figure 11.

**⚠ WARNING:** Always use the proper cutting stance described in this section. Never kneel when using the chain saw except when felling a tree as shown in Figure 16. Kneeling could result in loss of stability and control of the saw resulting in serious personal injury.

- Weight should be balanced with both feet on solid ground.
- Keep left arm with elbow locked in a “straight arm” position to withstand any kickback force.
- Your body should always be to the left of the chain line.
- Thumb should be on underside of handlebar.

## BASIC CUTTING PROCEDURE

Practice cutting a few small logs using the following technique to get the “feel” of using the saw before you begin a major sawing operation.

- Take the proper stance in front of the wood with the saw off.
- Squeeze the switch trigger and let the chain accelerate to full speed before entering the cut.
- Begin cutting with the saw against the log.
- Keep the unit running the entire time you are cutting, maintain a steady speed.
- Allow the chain to cut for you; exert only light downward pressure. If you force the cut, damage to the bar, chain, or unit can result.
- Release the switch trigger as soon as the cut is completed, allowing the chain to stop. If you run the saw without a cutting load, unnecessary wear can occur to the chain, bar, and unit.
- Do not put pressure on the saw at the end of the cut.

## WORK AREA PRECAUTIONS

- Cut only wood or materials made from wood, no sheet metal, no plastics, no masonry, no non-wood building materials.
- Never allow children to operate the saw. Allow no person to use this chain saw who has not read this Operator’s Manual or received adequate instructions for the safe and proper use of this chain saw.
- When felling a tree, keep everyone - helpers, bystanders, children, and animals - a safe distance from the cutting area. During felling operations, the safe distance should be a least twice the height of the largest trees in the felling area. During bucking operations, keep a minimum distance of 15 feet between workers. Trees should not be felled in a manner that would endanger any person, strike any utility line or cause any property damage. If the tree does make contact with any utility line, the utility company should be notified immediately.
- Always cut with both feet on solid ground to prevent being pulled off balance.
- Do not cut above shoulder height, as a saw held higher is difficult to control against kickback forces.
- Do not fell trees near electrical wires or buildings. Leave this operation for professionals.
- Cut only when visibility and light are adequate for you to see clearly.

# OPERATION

## TREE FELLING

See figure 12-16.

### Unusual Hazardous Tree Felling Conditions

Do not fell trees during periods of high wind or heavy precipitation. Wait to do your cutting until the hazard has ended.

**⚠ WARNING:** Do not cut down trees having an extreme lean or large trees that have rotten limbs, loose bark, or hollow trunks. Have these trees pushed or dragged down with heavy equipment, then cut them up.

**⚠ DANGER:** Electrocution hazard. Do not cut trees or branches near power lines or electrical wires. Contact with power lines or live electrical wires will result in serious personal injury or possible death.

**⚠ WARNING:** Do not cut trees or branches near buildings, which may result in serious injuries or property damage.

**⚠ WARNING:** Check the tree for damaged or dead branches that could fall and hit you during felling.

**⚠ WARNING:** Periodically glance at the top of the tree during the backcut to assure the tree is going to fall in the desired direction.

**⚠ WARNING:** If the tree starts to fall in the wrong direction, or if the saw gets caught or hung up during the fall, leave the saw and save yourself!

■ Felling a tree - When bucking and felling operations are being performed by two or more persons, at the same time, the felling operation should be separated from the bucking operation by a distance of at least twice the height of the tree being felled. Trees should not be felled in a manner that would endanger any person, strike any utility line or cause any property damage. If the tree does make contact with any utility line, the utility company should be notified immediately.

■ Before any cuts are started, pick your escape route (or routes in case the intended route is blocked); clear the immediate area around the

tree and make sure there are no obstructions in your planned path of retreat. Clear path of safe retreat approximately 135° from planned line of fall. The retreat path should extend back and diagonally to the rear of the expected line of fall.

■ Before felling is started, consider the force and direction of the wind, the lean and balance of the tree, and the location of large limbs. These things influence the direction in which the tree will fall. Do not try to fell a tree along a line different from its natural line of fall.

■ The chain saw operator should keep on the uphill side of the terrain as the tree is likely to roll or slide downhill after it is felled.

■ Remove dirt, stones, loose bark, nails, staples, and wire from the tree where felling cuts are to be made.

■ **Notched Undercut.** Cut a notch about 1/3 the diameter of the tree, perpendicular to the direction of fall. Make the cuts of the notch so they intersect at a right angle to the line of fall.

## OPERATION

This notch should be cleaned out to leave a straight line. To keep the weight of the wood off the saw, always make the lower cut of the notch before the upper cut.

See figure 14.

- **Felling Backcut.** The backcut is always made level and horizontal, and at a minimum of 2 in. above the horizontal cut of the notch.
- Never cut through to the notch. Always leave a band of wood between the notch and backcut (approximately 2 in. or 1/10 the diameter of the tree). This is called “hinge” or “hingewood.” It controls the fall of the tree and prevents slipping or twisting or shoot-back of the tree off the stump.
- On large diameter trees, stop the back cut before it is deep enough for the tree to either fall or settle back on the stump. Then insert soft wooden or plastic wedges into the cut so they do not touch the chain. The wedges can be driven in, little by little, to help jack the tree over.
- As tree starts to fall, stop the chain saw and put it down immediately. Retreat along the cleared path, but watch the action in case something falls your way. Be alert for overhead limbs or branches that may fall and watch your footing.

 **WARNING:** Never cut through to the notch when making a backcut. The hinge controls the fall of the tree, this is the section of wood between the notch and backcut.

### BUCKING

See figure 17-18.

Bucking is the term used for cutting a fallen tree to the desired log length.

- Always make sure your footing is secure and your weight is distributed evenly on both feet.
- Cut only one log at a time.
- Support small logs on a saw horse or another log while bucking.
- Keep a clear cutting area. Make sure that no objects can contact the guide bar nose and chain during cutting, this can cause kickback. Refer to **Precautions Against Kickback** earlier in this manual.



## OPERATION

- When bucking on a slope, always stand on the uphill side of the log. To maintain complete control of the chain saw when cutting through the log, release the cutting pressure near the end of the cut without relaxing your grip on the chain saw handles. Do not let the chain contact the ground. After completing the cut, wait for the saw chain to stop before you move the chain saw. Always stop the motor before moving from tree to tree.
- Sometimes it is impossible to avoid pinching (with just standard cutting techniques) or difficult to predict which way a log will settle when cut. To avoid pinching while cutting, rotate or move the log so that the pinch is eliminated.

### BUCKING LOGS UNDER STRESS

See figure 19.

When the log is supported along its entire length, it should be cut from the top or overbucking.

When the log is supported on one end, cut  $\frac{1}{3}$  the diameter from the underside or underbucking. Then make the finishing cut by overbucking to meet the first cut.

As the log is being cut, it will tend to bend. The saw can become pinched or hung in the log if you make the first cut deeper than  $\frac{1}{3}$  of the diameter of the log.

Give special attention to logs under stress to prevent the bar and chain from pinching.

When bucking on a slope, always stand on the uphill side of the log.

When "cutting through," to maintain complete control of the chain saw, release the cutting pressure near the end of the cut without relaxing your grip on the chain saw handles. Do not let the chain contact the ground. After completing the cut, wait for the saw chain to stop before you move the chain saw. Always stop the motor before moving from tree to tree.

### TYPES OF CUTTING USED

See figure 20.

#### OVERBUCKING

Begin on the top side of the log with the bottom of the saw against the log; exert light pressure downward. Note that the saw will tend to pull away from you.

#### UNDERBUCKING

Begin on the under side of the log with the top of the saw against the log; exert light pressure upward. During underbucking, the saw will tend to push back at you. Be prepared for this reaction and hold the saw firmly to maintain control.

## OPERATION

**⚠ WARNING:** Never climb into a tree to limb or prune. Do not stand on ladders, platforms, a log, or in any position which can cause you to lose your balance or control of the saw.

### LIMBING

See figure 21.

Limbing is removing branches from a fallen tree.

- Work slowly, keeping both hands on the chain saw with a firm grip. Always make sure your footing is secure and your weight is distributed evenly on both feet.
- Leave the larger support limbs under the tree to keep the tree off the ground while cutting.
- Limbs should be cut one at a time. Remove the cut limbs from the work area often to help keep the work area clean and safe.
- Branches under tension should be cut from the bottom up to avoid binding the chain saw.
- Keep the tree between you and the chain saw while limbing. Cut from the side of the tree opposite the branch you are cutting.

### PRUNING

See figure 22.

Pruning is trimming limbs from a live tree.

- Work slowly, keeping both hands on the chain saw with a firm grip. Always make sure your footing is secure and your weight is distributed evenly on both feet.
- Do not cut from a ladder, this is extremely dangerous. Leave this operation for professionals.
- Do not cut above shoulder height as a saw held higher is difficult to control against kickback.
- When pruning trees it is important not to make the finishing cut next to the main limb or trunk until you have cut off the limb further out to reduce the weight. This prevents stripping the bark from the main member.
- Underbuck the branch 1/3 through for your first cut.
- Your second cut should overbuck to drop the branch off.
- Now make your finishing cut smoothly and neatly against the main member so the bark will grow back to seal the wound.

**⚠ WARNING:** If the limbs to be pruned are above shoulder height, hire a professional to perform the pruning.

## OPERATION

### SPRINGPOLES

See figure 23.

A springpole is any log, branch, rooted stump, or sapling which is bent under tension by other wood so that it springs back if the wood holding it is cut or removed. On a fallen tree, a rooted stump has a high potential of springing back to the upright position during the bucking cut to separate the log from the stump. Watch out for springpoles, they are dangerous.

**⚠ WARNING:** Springpoles are dangerous and could strike the operator, causing the operator to lose control of the chain saw. This could result in severe or fatal injury to the operator.

## MAINTENANCE

**⚠ WARNING:** When servicing, use only identical replacement parts. Use of any other parts may create a hazard or cause product damage.

**⚠ WARNING:** Always wear eye protection with side shields marked to comply with ANSI Z87.1, along with head protection. Failure to do so could result in objects being thrown into your eyes and other possible serious injuries. If operation is dusty, also wear breathing protection.

**⚠ WARNING:** To avoid serious personal injury, always remove the battery pack from the product when cleaning or performing any maintenance.

### GENERAL MAINTENANCE

Before each use, inspect the entire product for damaged, missing, or loose parts such as screws, nuts, bolts, caps, etc. Tighten securely all fasteners and caps and do not operate this product until all missing or damaged parts are replaced. Please call 1-888-266-7096 or contact an authorized service center for assistance.

Avoid using solvents when cleaning plastic parts. Most plastics are susceptible to damage from various types of commercial solvents and may be damaged by their use. Use clean cloths to remove dirt, dust, oil, grease, etc.

**⚠ WARNING:** Do not at any time let brake fluids, gasoline, petroleum-based products, penetrating oils, etc., come in contact with plastic parts. Chemicals can damage, weaken or destroy plastic which may result in serious personal injury.

Only the parts shown on the parts list are intended to be repaired or replaced by the customer. All other parts should be replaced at an Authorized Service Center.

### BATTERIES

This product will accept Craftsman® 40 V lithium-ion battery packs and Craftsman 40 V Lithium-ion battery packs.

The batteries for this product have been designed to provide maximum trouble-free life. However, like all batteries, they will eventually wear out. Do not disassemble battery pack and attempt to replace the batteries. Handling of these batteries, especially when wearing rings and jewelry, could result in a serious burn.

To obtain the longest possible battery life, we suggest the following:

#### For lithium-ion batteries:

- Remove the battery pack from the charger once it is fully charged and ready for use.
- For battery pack storage longer than 30 days:
- Store the battery pack where the temperature is below 80°F and away from moisture.
  - Store battery packs in a 30%-50% charged condition.
  - Every six months of storage, charge the pack as normal.

# MAINTENANCE

## For Lithium-ion batteries:

- Craftsman 40 V lithium-ion batteries are designed with features that protect the lithium-ion cells and maximize battery life. Under some operating conditions, these built-in features may cause the battery and the tool it is powering to act differently from nickel-cadmium batteries.
- During some applications, the battery electronics may signal the battery to shut down, and cause the tool to stop running. To reset the battery and tool, place the power switch in the OFF position; then start the unit and resume normal operation.
- If placing the power switch in the OFF position does not reset the battery and tool, the battery pack is depleted. If depleted, the battery pack will begin charging when placed on the lithium-ion charger.

## BATTERY PACK REMOVAL AND PREPARATION FOR RECYCLING

See figure 24-28.

**⚠ WARNING:** Upon removal, cover the battery pack's terminals with heavy-duty adhesive tape. Do not attempt to destroy or disassemble battery pack or remove any of its components. Lithium-ion and nickel-cadmium batteries must be recycled or disposed of properly. Also, never touch both terminals with metal objects and/or body parts as short circuit may result. Keep away from children. Failure to comply with these warnings could result in fire and/or serious injury

## REPLACING BAR AND CHAIN

**⚠ WARNING:** Remove the battery pack from the chain saw and make sure the chain has stopped before you do any work or making any adjustments on the saw. Failure to do so may result in accidental starting and possible serious injury.

**⚠ WARNING:** The safety instructions in this section are to protect the user from serious personal injury.

**⚠ WARNING:** Always wear gloves when handling the bar and chain; these components are sharp and may contain burrs.

**⚠ WARNING:** Never touch or adjust the chain while the motor is running. The saw chain is very sharp; always wear protective gloves when performing maintenance to the chain to avoid possible serious lacerations.

- Remove the battery pack before you do any work on the chain saw.
- Remove the hex key from the storage area and use it to remove the chain cover screw, washer and chain cover from the chain saw.
- Remove the bar and chain from the mounting surface.
- Remove the old chain from the bar.
- Lay out the new saw chain in a loop and straighten any kinks. The cutters should face in the direction of chain rotation. If they face the opposite direction, turn the loop over.
- Place the chain drive links into the bar groove. Position the chain so there is a loop at the back of the bar. Hold the chain in position on the bar and place the loop around the sprocket of the chain saw. Fit the bar flush against the mounting surface so that the bar stud is in the long slot of the bar.

# MAINTENANCE

## RECOMMENDED BAR AND CHAIN COMBINATIONS

**Bar Part Number - 12 in.**

120SDEA041

**Chain Part Number**

91P045X/91PX045X

- Replace the chain cover, washer and chain cover screw. Tighten the chain cover screw finger tight only. The bar must be free to move for tension adjustment.
- Remove all the slack from the chain by turning the chain tensioning screw clockwise until the chain seats snugly against the bar with the drive links in the bar groove.
- Lift the tip of the guide bar up to check for sag. Release the tip of the guide bar and turn the chain tensioning screw 1/2 turn clockwise. Repeat this process until sag does not exist.
- Hold the tip of the guide bar up and tighten the bar mounting screw securely.
- Chain is correctly tensioned when there is no sag on the underside of the guide bar, the chain is snug, but it can be turned by hand without binding.

## CHAIN TENSION

See figure 29-30.

- Stop the motor before setting the chain tension. Make sure the guide bar screw is loosened to finger tight, turn the chain tensioner clockwise to tension the chain. Refer to **Replacing Bar and Chain** earlier in this manual for additional information.
- A cold chain is correctly tensioned when there is no slack on the underside of the guide bar, the chain is snug, but it can be turned by hand without binding.
- Chain must be re-tensioned whenever the flats on the drive links hang out of the bar groove.
- During normal saw operation, the temperature of the chain will increase. The drive links of a correctly tensioned warm chain will hang approximately .050 in. out of the bar groove.

**NOTE:** New chain tends to stretch, check chain tension frequently and tension as required.

## MAINTENANCE

**CAUTION:** Chain tensioned while warm, may be too tight upon cooling. Check the “cold tension” before next use.

### CHAIN MAINTENANCE

See figure 31-32.

**WARNING:** Remove the battery pack and make sure the chain has stopped before you do any work or making any adjustments on the saw. Failure to do so may result in accidental starting and possible serious injury.

Use only low-kickback chain on this saw. This fast-cutting chain will provide kickback reduction when properly maintained.

For smooth and fast cutting, chain needs to be maintained properly. The chain requires sharpening when the wood chips are small and powdery, the chain must be forced through the wood during cutting, or the chain cuts to one side. During maintenance of your chain, consider the following:

- Improper filing angle of the side plate can increase the risk of a severe kickback.
- Raker (depth gauge) clearance. Too low increases the potential for kickback. Not low enough decreases cutting ability.
- If cutter teeth have hit hard objects such as nails and stones, or have been abraded by mud or sand on the wood, have service dealer sharpen chain.

**NOTE:** Inspect the drive sprocket for wear or damage when replacing the chain. If signs of wear or damage are present in the areas indicated, have the drive sprocket replaced by a Craftsman Service dealer.

### HOW TO SHARPEN THE CUTTERS

See figure 33-34.

Be careful to file all cutters to the specified angles and to the same length, as fast cutting can be obtained only when all cutters are uniform.

- Wear gloves for protection. Properly tension the chain prior to sharpening. Refer to **Chain Tension Section** earlier in this manual. Do all of your filing at the mid-point of the bar.
- Use a 5/32 in. diameter round file and holder.
- Keep the file level with the top plate of the tooth. Do not let the file dip or rock.
- Using light but firm pressure, stroke towards the front corner of the tooth.
- Lift file away from the steel on each return stroke.

# MAINTENANCE

- Put a few firm strokes on every tooth. File all left hand cutters in one direction. Then move to the other side and file the right hand cutters in the opposite direction. Occasionally remove filings from the file with a wire brush.

**⚠ WARNING:** Improper chain sharpening increases the potential of kickback.

**⚠ WARNING:** Failure to replace or repair damaged chain can cause serious injury.

**⚠ WARNING:** The saw chain is very sharp, always wear protective gloves when performing maintenance to the chain.

## TOP PLATE FILING ANGLE

See figure 35.

- **CORRECT 30°** - File holders are marked with guide marks to align file properly to produce correct top plate angle.
- **LESS THAN 30°** - For Cross Cutting.
- **MORE THAN 30°** - Feathered Edge Dulls Quickly.

## SIDE PLATE ANGLE

See figure 36.

- **CORRECT - 80°** Produced automatically if correct diameter file is used in file holder.
- **HOOKE** - "Grabs" and dulls quickly. Increases potential of **KICKBACK**.  
Results from using a file with diameter too small, or file held too low.
- **BACKWARD SLOPE** - Needs too much feed pressure, causes excessive wear to bar and chain.  
Results from using a file with diameter too large, or file held too high.

## DEPTH GAUGE CLEARANCE

See figure 37-39.

- The Raker (depth gauge) should be maintained at a clearance of .025 in. Use a depth gauge tool for checking the depth gauge clearances.

# MAINTENANCE

- Every time the chain is filed, check the depth gauge clearance.

Use a Flat File and a Depth Gauge Jointer to lower all gauges uniformly. Depth gauge jointers are available in .020 in. to .035 in. Use a .025 in. depth gauge jointer. After lowering each depth gauge, restore original shape by rounding the front. Be careful not to damage adjoining drive links with the edge of the file.

Depth gauges must be adjusted with the flat file in the same direction the adjoining cutter was filed with the round file. Use care not to contact cutter face with flat file when adjusting depth gauges.

## GUIDE BAR MAINTENANCE

See figure 40.

When the guide bar shows signs of wear, reverse it on the saw to distribute the wear for maximum bar life. The bar should be cleaned every day of use and checked for wear and damage.

Feathering or burring of the bar rails is a normal process of bar wear. Such faults should be smoothed with a file as soon as they occur.

A bar with any of the following faults should be replaced.

- Wear inside the bar rails which permits the chain to lay over sideways.
- Bent guide bar.
- Cracked or broken rails.
- Spread rails.

In addition, guide bars with a sprocket at their tip must be lubricated weekly with a grease syringe to extend the guide bar life. Using a grease syringe, lubricate weekly in the lubricating hole.

Turn the guide bar and check that the lubrication holes and chain groove are free from impurities.



# MAINTENANCE

## REVERSING THE GUIDE BAR

- Remove the chain from the bar and turn the bar over.

**NOTE:** Bottom of bar should not be on top.

- Replace the chain on the bar. Refer to **Assembling the Bar and Chain** earlier in this manual for specific information.
- Tighten the screw with your finger.
- From the finger-tight position, tighten the screw an additional 3/4 of a turn using a wrench.

**⚠ WARNING:** Remove the battery pack and make sure the chain has stopped before you do any work or making any adjustments on the saw. Failure to do so may result in accidental starting and possible serious injury.

## TRANSPORTING AND STORING

See figure 41.

- Do not store or transport the chain saw when it is running. The chain saw should always be idle before storing or transporting.
- Always place the chain cover on the bar and chain before storing or transporting the chain saw. Use caution to avoid the sharp teeth of the chain.
- Clean the chain saw thoroughly before storing. Store the chain saw indoors, in a dry place that is locked and/or inaccessible to children.
- Keep away from corrosive agents such as garden chemicals and de-icing salts.

## TROUBLESHOOTING

PROBLEM	CAUSE	SOLUTION
Bar and chain running hot and smoking.	<ol style="list-style-type: none"><li>1. Check chain tension for over tight condition</li><li>2. Chain oil tank empty.</li></ol>	<ol style="list-style-type: none"><li>1. Tension chain. Refer to <b>Chain Tension</b> earlier in this manual.</li><li>2. Check oil tank.</li></ol>
Motor runs, but chain is not rotating.	<ol style="list-style-type: none"><li>1. Chain tension too tight.</li><li>2. Check guide bar and chain assembly.</li><li>3. Check guide bar and chain for damage.</li></ol>	<ol style="list-style-type: none"><li>1. Retension chain, Refer to <b>Chain Tension</b> earlier in this manual.</li><li>2. Refer to <b>Assembling the Bar and Chain</b> earlier in this manual.</li><li>3. Inspect guide bar and chain for damage.</li></ol>

### CALL US FIRST

For any questions about operating or maintaining your product, call the Craftsman® Help Line!

Your product has been fully tested prior to shipment to ensure your complete satisfaction.

## CRAFTSMAN CHAINSAW – MODEL NUMBER 138-98946

The model number will be found on a plate attached to the motor housing. Always mention the model number in all correspondence regarding your **CHAIN SAW** or when ordering repair parts.

### SEE BACK PAGE FOR PARTS ORDERING INSTRUCTIONS

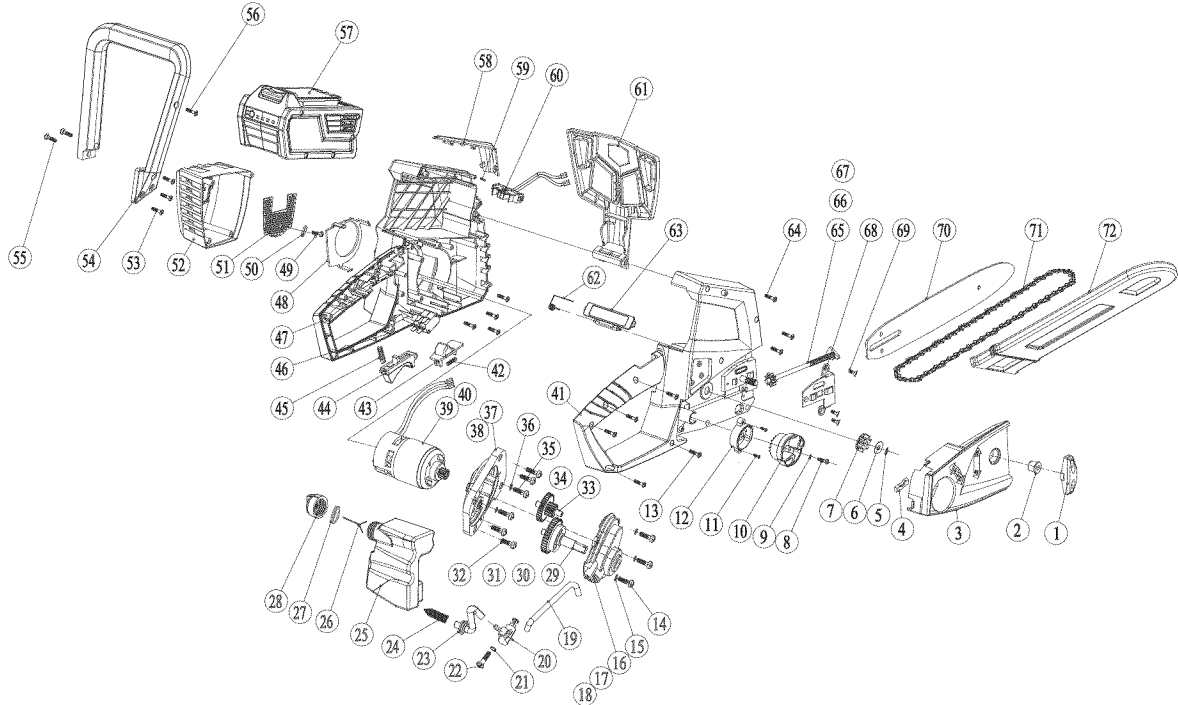

Key No.	Part Number	Description	Qty.
1	34109583-1	SIDE COVER KNOB	1
2	33901420	BUSH	1
3	34107587	SIDE COVER	1
4	34203420	RUBBER CLIP	1
5	3290875A	WASHER	1
6	33302102	WASHER HSF	1
7	33902102-1	CHAIN WHEEL	1
8	3220313A	SCREW ST4.2X14	1
9	3290186A	WASHER	1
10	34106587	TENSION KNOB	1
11	32202391	SCREW ST3.5X12-F	2
12	34108420	TENSION KNOB CLIP	1
13	3220313A	SCREW	12
14	3221198	SCREW M4X14	3
15	32911301A	SPRING WASHER	3
16	33101420	GEAR BOX COVER	1
17	32104154	6000 BEARING	1
18	3210111	BEARING	1
19	34201420	OIL OUTLET TUBE	1
20	31100329	OIL PUMP ASSY	1
21	3290186A	WASHER	1
22	3220811	SCREW M4X16	1
23	34202420	OIL TUBE	1
24	32208159 -1	SPRING	1
25	34104581	OIL TANK	1
26	34107583	OIL TANK DISTAFF	1
27	34202583	OIL CAN WASHER	1
28	34105587	OIL CAN OVER	1
29	33203587	OUTPUT SHAFT	1
30	33902420	CAM FOR OIL PUMP	1
31	33903329	GEAR C	1
32	3220313A	SCREW	4
33	33202329-1	GEAR B	1
34	33902329	GEAR A	1

## PARTS LIST

Key No.	Part Number	Description	Qty.
35	32201155	SCREW M4X9 .....	2
36	32916131	SPRING WASHER .....	2
37	33100420-2	GEAR BOX .....	1
38	3210111	BEARING .....	1
39	36101622-1	MOTOR .....	1
40	33901329	GEARING .....	1
41	34100587	RIGHT HOUSING .....	1
42	33211587	SPRING .....	1
43	34109587	SWITCH KNOB .....	1
44	34108587	SWITCH TRIGGER .....	1
45	33201587	SPRING .....	1
46	36300420	SWITCH .....	1
47	34101587	LEFT HOUSING .....	1
48	34113587	INNER VELLETT .....	1
49	3220248	SCREW .....	1
50	3290186A	WASHER .....	1
51	33302587	BOARD .....	1
52	34110587	MOTOR COVER .....	1
53	3220313A	SCREW .....	12
54	34102587	HANDLE .....	1
55	3220313A	SCREW .....	2
56	3220313A	SCREW .....	1
57	31102996	BATTERY ASSY .....	1
58	34104587	ORNAMENT BOARD .....	1
59	32901115	PIN .....	1
60	34104978	BRACKET .....	1
61	34103587	GUARD .....	1
62	33200587	TORTION SPRING .....	1
63	34111587	BOARD .....	1
64	3220313A	SCREW .....	4
65	32207159-1	TENSION GEAR SHAFT .....	1
66	33305420	TENSION BOARD .....	1
67	33904159	TENSION GEAR .....	1
68	33301587	BAR WASHER .....	1
69	32201329	SCREW ST4.2X10 .....	3
70	31100581-2	BAR .....	1
71	31101420-1	CHAIN .....	1
72	34114155-3	SHEATH .....	1

## Free Manuals Download Website

<http://myh66.com>

<http://usermanuals.us>

<http://www.somanuals.com>

<http://www.4manuals.cc>

<http://www.manual-lib.com>

<http://www.404manual.com>

<http://www.luxmanual.com>

<http://aubethermostatmanual.com>

Golf course search by state

<http://golfingnear.com>

Email search by domain

<http://emailbydomain.com>

Auto manuals search

<http://auto.somanuals.com>

TV manuals search

<http://tv.somanuals.com>