

## Operator's Manual

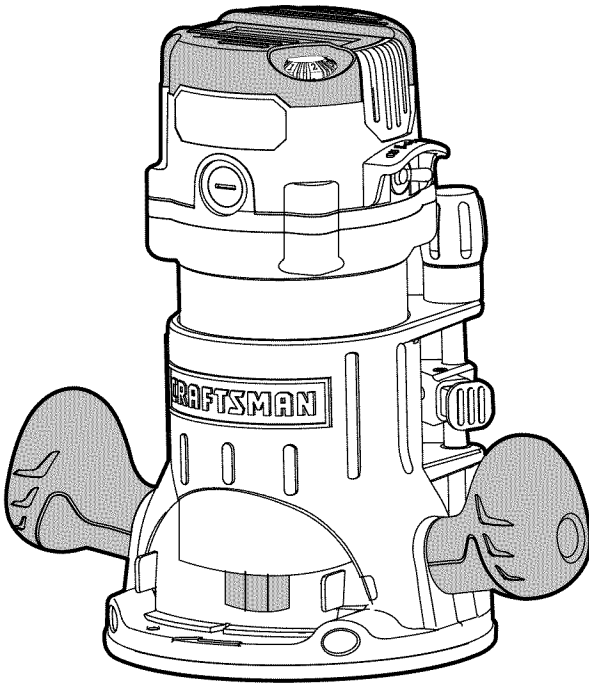

# 12.0 Amp Fixed Base Router

Model No. 320.2768



**▲ WARNING:** To reduce the risk of injury, the user must read and understand the Operator's manual before using this product.

- WARRANTY
- SAFETY
- UNPACKING
- DESCRIPTION
- OPERATION
- MAINTENANCE
- TROUBLESHOOTING
- ESPANÖL

Sears Brands Management Corporation, Hoffman Estates, IL 60179 U.S.A.

[www.craftsman.com](http://www.craftsman.com)

## TABLE OF CONTENTS

Warranty	page 2
Safety Symbols	page 3-4
Safety Instructions	page 5-10
Unpacking	page 10-11
Description	page 12-14
Operation	page 14-29
Maintenance	page 30-31
Troubleshooting	page 32
Exploded View and Part List	page 35-39
Sears Repair Parts Phone Number	Back Cover

### **CRAFTSMAN ONE YEAR LIMITED WARRANTY**

FOR ONE YEAR from the date of purchase, this product is warranted against any defects in material or workmanship. With proof of purchase, defective product will be replaced free of charge.

**For warranty coverage details to obtain free replacement, visit the web site: [www.craftsman.com](http://www.craftsman.com)**

This warranty is void if this product is ever used while providing commercial services or if rented to another person.

This warranty gives you specific legal rights, and you may also have other rights which vary from state to state.

Sears Brands Management Corporation, Hoffman Estates, IL 60179

**⚠ WARNING:** Some dust created by using power tools contains chemicals known to the state of California to cause cancer and birth defects or other reproductive harm.

**SAVE THESE INSTRUCTIONS!**

**READ ALL INSTRUCTIONS!**

This router has many features for making its use more pleasant and enjoyable. Safety, performance, and dependability have been given top priority in the design of this product making it easy to maintain and operate

## SAFETY SYMBOLS

The purpose of safety symbols is to attract your attention to possible dangers.

The safety symbols and the explanations with them deserve your careful attention and understanding. The symbol warnings do not, by themselves, eliminate any danger. The instructions and warnings they give are no substitutes for proper accident prevention measures.

**⚠ WARNING:** Be sure to read and understand all safety instructions in this manual, including all safety alert symbols such as “**DANGER**,” “**WARNING**,” and “**CAUTION**” before using this router. Failure to follow all instructions listed in this manual may result in electric shock, fire and/or serious personal injury.

### SYMBOL SIGNAL MEANING

**⚠ SAFETY ALERT SYMBOL:** Indicates **DANGER, WARNING, OR CAUTION**. May be used in conjunction with other symbols or pictographs

**⚠ DANGER:** Indicates an imminently hazardous situation, which, if not avoided, will result in death or serious injury.

**⚠ WARNING:** Indicates a potentially hazardous situation, which, if not avoided, could result in death or serious injury.

**⚠ CAUTION:** Indicates an imminently hazardous situation, which, if not avoided, may result in death or serious injury.

### Damage Prevention and Information Messages

These inform the user of important information and/or instructions that could lead to equipment or other property damage if they are not followed. Each message is preceded by the word “NOTE,” as in the example below:

**NOTE:** Equipment and/or property damage may result if these instructions are not followed.









**⚠ WARNING:** To ensure safety and reliability, all repairs should be performed at a Sears Parts & Repair Service Center.



**⚠ WARNING:** The operation of any power tools can result in foreign objects being thrown into your eyes, which can result in severe eye damage. Before beginning power tool operation, always wear safety goggles or safety glasses with side shield and a full face shield when needed. We recommend a Wide Vision Safety Mask for use over eyeglasses or standard safety glasses with side shields. Always use eye protection which is marked to comply with ANSI Z87.1

### SAVE THESE INSTRUCTIONS

Some of the following symbols may be used on this tool. Please study them and learn their meaning. Proper interpretation of these symbols will allow you to operate the tool better and more safely.

SYMBOL	NAME	DESIGNATION/EXPLANATION
V	Volts	Voltage
A	Amperes	Current
Hz	Hertz	Frequency (cycles per second)
W	Watt	Power
min	Minutes	Time
~	Alternating Current	Type of current
≡	Direct Current	Type or a characteristic of current
$n_0$	No Load Speed	Rotational speed, at no load
	Class II Construction	Double-insulated construction
.../min	Per Minute	Revolutions, strokes, surface speed, orbits, etc., per minute
	Wet Conditions Alert	Do not expose to rain or use in damp locations.
	Read The Operator's Manual	To reduce the risk of injury, user must read and understand operator's manual before using this product.
	Eye Protection	Always wear safety goggles or safety glasses with side shields and a full face shield when operating this product.
	Safety Alert	Precautions that involve your safety.
	No Hands Symbol	Failure to keep your hands away from the blade will result in serious personal injury.
	No Hands Symbol	Failure to keep your hands away from the blade will result in serious personal injury.
	No Hands Symbol	Failure to keep your hands away from the blade will result in serious personal injury.
	No Hands Symbol	Failure to keep your hands away from the blade will result in serious personal injury.
	Hot Surface	To reduce the risk of injury or damage, avoid contact with any hot surface.

# SAFETY INSTRUCTIONS

## GENERAL POWER TOOL SAFETY WARNINGS

**⚠ WARNING:** Read all safety warnings and instructions. Failure to follow the warnings and instructions may result in electric shock, fire and/or serious injury.

- **Know your power tool.** Read the operator's manual carefully. Learn the applications, as well as the specific potential hazards related to this tool. Following this rule will reduce the risk of electric shock, fire or serious injury.
- **Save these instructions.** Refer to them frequently and use them to instruct others who may use this tool. If someone borrows this tool, make sure they have these instructions also.
- **The term "power tool" in the warnings refers to your mains-operated (corded) power tool or battery-operated (cordless) power tool.**

## READ AND SAVE THESE INSTRUCTIONS

### WORK AREA SAFETY

- **Keep the work area clean and well lit.** Cluttered or dark areas invite accidents.
- **Do not operate power tools in explosive atmospheres, such as in the presence of flammable liquids, gases or dust.** Power tools create sparks which may ignite the dust or fumes.
- **Keep children and bystanders away while operating a power tool.** Distractions can cause you to lose control.

### ELECTRICAL SAFETY

- **Power tool plugs must match the outlet. Never modify the plug in any way. Do not use any adapter plugs with earthed (grounded) power tools.** Unmodified plugs and matching outlets will reduce risk of electric shock
- **Avoid body contact with earthed or grounded surfaces such as pipes, radiators, ranges and refrigerators.** There is an increased risk of electric shock if your body is earthed or grounded.
- **Do not expose power tools to rain or wet conditions.** Water entering a power tool will increase the risk of electric shock.
- **Inspect the tool cords periodically and, if damaged, have them repaired at your nearest Sears Service Center.** Be aware of the cord location.
- **Do not abuse the cord. Never use the cord for carrying, pulling or unplugging the power tool. Keep the cord away from heat, oil, sharp edges or moving parts.** Damaged or entangled cords increase the risk of electric shock.

- **When operating a power tool outdoors, use an extension cord suitable for outdoor use.** Use of a cord suitable for outdoor use reduces the risk of electric shock.
- **If operating a power tool in a damp location is unavoidable, use a ground fault circuit interrupter (GFCI) protected supply.** Use of a GFCI reduces the risk of electric shock.

## PERSONAL SAFETY

- **Stay alert, watch what you are doing and use common sense when operating a power tool. Do not use the tool while tired or under the influence of drugs, alcohol, or medication.** A moment of inattention while operating power tools may result in serious personal injury.
- **Know your power tool. Read the operator's manual carefully.** Learn the applications, as well as the specific potential hazards related to this tool. Following this rule will reduce the risk of electric shock, fire or serious injury.
- **Always wear safety glasses or eye shields when using this router.** Everyday eyeglasses have only impact-resistant lenses; they are not safety glasses.
- **Protect your lungs.** Wear a face mask or dust mask if the operation is dusty.
- **Protect your hearing.** Wear appropriate personal hearing protection during use. Under some conditions noise from this product may contribute to hearing loss.
- **All visitors and bystanders must** wear the same safety equipment that the operator of the router wears.
- **Prevent unintentional starting.** Ensure that the switch is in the OFF-position before connecting to a power source and/or battery, picking up or carrying the tool. Carrying power tools with your finger on the switch or energizing power tools that have the switch on invites accidents.
- **Remove any adjusting key or wrench before turning the power tool on.** A wrench or a key left attached to a rotating part of the power tool may result in personal injury.
- **Do not overreach. Keep proper footing and balance at all times.** This enables better control of the power tool in unexpected situations.
- **Dress properly. Do not wear loose clothing or jewelry. Keep your hair, clothing and gloves away from moving parts.** Loose clothes, jewelry or long hair can be caught in moving parts.
- **If devices are provided for the connection of dust extraction and collection facilities, ensure that these are connected and properly used.** Use of these devices can reduce dust-related hazards.

## POWER TOOL USE AND CARE

- **Do not force the power tool. Use the correct power tool for your application.** The correct power tool will do the job better and more safely at the rate for which it was designed.
- **Do not use the power tool if the switch does not turn it on and off.** Any power tool that cannot be controlled with the switch is dangerous and must be repaired.
- **Always check the tool for damaged parts before use.** Before further use of the tool, a guard or other part that is damaged should be carefully checked to determine if it will operate properly and perform its intended function. Check for misalignment or binding of moving parts, breakage of parts, and any other condition that may affect the tool's operation. A guard or other part that is damaged should be properly repaired or replaced at a Sears Service Center.
- **Disconnect the plug from the power source and/or the battery from the power tool before making any adjustments, changing accessories, or storing power tools.** Such preventive safety measures reduce the risk of starting the power tool accidentally.
- **Store idle power tools out of the reach of children and do not allow persons unfamiliar with the power tool or these instructions to operate the power tool.** Power tools are dangerous in the hands of untrained users.
- **Maintain power tools. Check for misalignment or binding of moving parts, breakage of parts and any other condition that may affect the power tool operation. If damaged, have the power tool repaired before use.** Many accidents are caused by poorly maintained power tools.
- **Keep cutting tools sharp and clean.** Properly maintained cutting tools with sharp cutting edges are less likely to bind and are easier to control.
- **Use the power tool, accessories, tool bits, etc., in accordance with these instructions, taking into account the working conditions and the work to be performed.** Use of the power tool for operations different from those intended could result in a hazardous situation.

 **WARNING:** When using power tools, basic safety precautions should always be followed to reduce the risk of fire, electric shock, and personal injury.

 **WARNING:** The operation of any tool can result in foreign objects being propelled into your eyes, resulting in severe eye damage. When operating power tool, always wear safety goggles or safety glasses with side shields and a full face shield when needed.

 **WARNING:** If any parts are missing, do not operate the tool until the missing parts have been replaced. Doing so could result in serious personal injury.

## SERVICE SAFETY

- **Have your power tool serviced by a qualified repair person using only identical replacement parts.** This will ensure that the safety of the power tool is maintained.
- **If any part of this router is missing or should break, bend, or fail** in any way; or should any electrical component fail to perform properly: shut off the power switch and remove the plug from the power source and have the missing, damaged, or failed parts replaced before resuming operation.
- **Tool service** must be performed only at a Sears Parts & Repair Service Center. Service or maintenance performed by unqualified personnel could result in a risk of injury.
- **Use only identical replacement parts** when servicing a tool. Follow the instructions in the maintenance section of this manual. Use of unauthorized parts or failure to follow maintenance instructions may create a risk of electric shock or injury.

## SPECIFIC SAFETY RULES FOR ROUTER

- **Hold power tools by insulated gripping surfaces** when performing an operation where the cutting tool may contact hidden wiring or its own cord. Contact with a “live” wire will make exposed metal parts of the tool “live” and shock the operator.
- **Use clamps or another practical way to support and secure the workpiece to a stable platform.** Holding the work by hand or against your body leaves it unstable and may lead to loss of control.
- **Maintain a firm grip** on the router with both hands to resist starting torque.
- **Never attempt to use the router motor without first installing it in an approved fixed base.** Failure to heed this warning could result in personal injury and damage to the motor.
- **Make sure that the motor housing does not move up or down when clamped in the fixed base. If the motor is not securely clamped into the base, injury could result and adjustments will not be accurate.**
- **Do not hand-hold the router in an upside down or horizontal position.** The motor can separate from the base if not properly attached according to the instructions.
- **Tighten the collet/nut securely to prevent the cutter bit from slipping.** If the collet/nut is not securely tightened, the cutter bit may detach during use, causing serious personal injury.
- **Never tighten the collet/nut without a cutter bit installed in the collet/nut.**
- **Never hold the piece being cut in your hands or across your legs.** It is important to support and clamp the workpiece properly in order to minimize body exposure, bit binding, or loss of control.



- **Always keep the chip shield clean and in place.**
- **Stay alert and clear the router cutter bit path of any obstructions before starting the motor.** Keep cutting area clear of all foreign objects while the motor is running.
- **Inspect and remove all nails from lumber before routing.**
- **Check to see that the cord will not “hang up” during routing operation.**
- **Make sure that the cutter bit is not in contact with the workpiece before the switch is turned on. The bit must always be running at full speed before contacting the workpiece.**
- **Keep hands clear** of the cutter bit when the motor is running to prevent personal injury.
- **Provide clearance under the workpiece** for the router cutter bit when through-cutting.
- **Keep cutting pressure constant.** Do not overload the motor.
- **Use only sharp cutter bits** that are not chipped or cracked. Blunt cutter bits will cause stalling and burn the workpiece.
- **Never use this router motor with a cutter bit larger than 3-1/2 inches in diameter.**
- **Always use cutter bits that are designed for this router. Never use cutter bits which are larger in diameter than the opening in the router sub-base.** Cutter bits that have cutter diameters larger than the opening could cause possible loss of control or create other hazardous condition that could cause serious personal injury.
- **The sub-base on this fixed base router has an opening of 1-1/4 inches.** To use cutter bits with a larger diameter, install and use a sub-base with a larger diameter opening (sold separately at Sears stores or other Craftsman outlets).
- **Do not use large router cutter bits for freehand routing.** Use of large cutter bits when freehand routing could cause loss of control or create hazardous conditions that could result in serious personal injury. If using a router table, large bits should be used for edging only.
- **Be sure that the cutter bit is centered in a template guide** (sold separately) prior to template guide applications to avoid personal injury or damage to finished work.
- **Do not remove more than 1/8 inch in a single pass.** Excessive depth of cut can result in loss of control that could result in personal injury.
- **After completing a cut, turn the motor OFF and let it come to complete stop before removing router from workpiece.**
- **Let the motor come to a complete stop before putting the router down.** Cutter bits coast after the power is turned off.

- **Only use router tables with on-board switch-controlled receptacles.** Failure to use router tables with all the appropriate safety features could result in serious personal injury.
- **Disconnect the tool from the power source** before making any adjustments or changing cutter bits.
- **If you are changing a bit immediately after use, be careful not to touch the collet/nut or cutter bit with your hands or fingers.** The heat buildup from cutting could cause severe burns. Always use the wrench provided.
- **Avoid “climb cutting;” see “Direction of Feed in” section in this manual.** “Climb cutting” increases the chance for loss of control resulting in possible serious injury.

**⚠ WARNING:** Bits, sockets, and tools get hot during operation. Wear gloves when touching them.

**⚠ WARNING:** Wear ear protection. Exposure to noise can cause hearing loss.

**⚠ WARNING:** To avoid injury, hold the tool by the insulated gripping surfaces only. If the tool contacts hidden wiring or its own cord, exposed metal parts of the tool could shock the operator and cause serious injury. Make sure that hidden electrical wiring, water pipes, or other hazards are not in the cutting path.

## UNPACKING

**⚠ WARNING:** Your router should never be connected to the power source when you are assembling parts, making adjustments, installing or removing bits, cleaning, or when it is not in use. Disconnecting the router will prevent accidental starting, which could cause serious personal injury.







When unpacking the box, do not discard any packing materials until all of the contents are accounted for:

1. Carefully lift the router out of the carton and place on a stable, flat surface.
2. Open the carton to locate the following:
  - Vacuum port
  - Chip shield (already installed on router)
  - 1/4 inch collet/nut
  - 1/2 inch collet/Nut (already installed on router)
  - Collet/nut wrench
  - Depth-Adjustment Wrench
  - Edge Guide
  - Manual

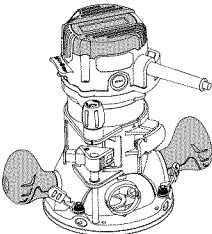
3. Inspect the items carefully to make sure that no breakage or damage has occurred during shipping. If any of the items mentioned is missing, (refer to "PARTS LIST" illustration), return the router to your nearest Sears store to have the router replaced.

**▲ WARNING:** If any part is broken or missing, do not attempt to assemble the router, plug in the power cord, or operate the router until the broken or missing part is replaced. Failure to do so could result in possible serious injury.

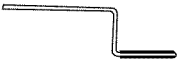
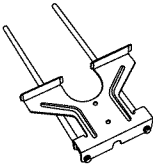
CARTON CONTENTS/LOOSE PARTS (Fig. 1)

	<p>Fixed Base Router</p>
	<p>Chip shield (already installed on router)</p>
	<p>Vacuum port</p>
	<p>1/4 inch Collet/Nut 1/2 inch Collet/Nut (already installed on router)</p>
	<p>Depth-Adjustment Wrench</p>
	<p>Edge Guide</p>
	<p>Collet/Nut Wrench</p>

# DESCRIPTION

## KNOW YOUR ROUTER (Fig.1)

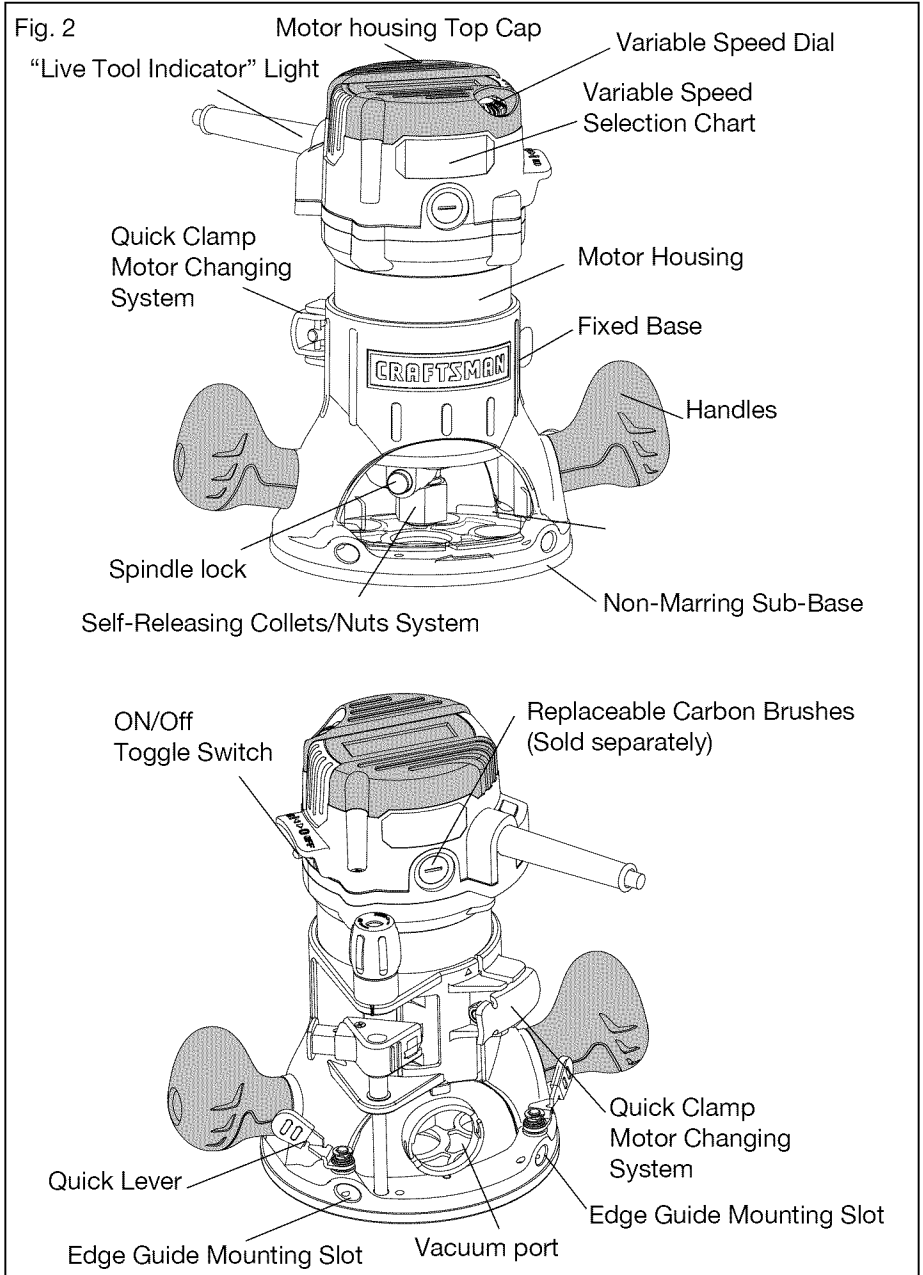

**NOTE:** Before attempting to use your router, familiarize yourself with all of the operating features and safety requirements.

Your fixed base router has a precision-built electric motor and it should only be connected to a 120-volt, 60-Hz AC only power supply (normal household current). Do not operate on direct current (DC). This large voltage drop will cause a loss of power and the motor will overheat. If the router does not operate when plugged into a correct 120-volt, 60-Hz AC only outlet, check the power supply. This router has an 8-ft., 2-wire power cord (no adapter needed).

**▲ WARNING:** Do not allow familiarity with the router to cause a lack of alertness. A fraction of a second of carelessness is enough to cause severe injury

PRODUCT SPECIFICATIONS	
Rating	12.0 Amps
No Load Speed	10,000-25,000 RPM
Peak HP	2
Input	120-volt, 60Hz AC
Collets/Nuts and Cutter bit Shank Diameters	1/4 in. and 1/2 in.
Fixed Base Diameter	6 inches
Sub-Base Opening (Diameter for cutter bit use)	1-1/4 inches
Sub-Base Thickness	1/4 inch (6mm)
Fixed Base Depth of Cut	1-3/4 inches (45mm)

**▲ WARNING:** The safe use of this product requires an understanding of the information on the tool and in this operator's manual, as well as knowledge of the project you are attempting. Before use of this product, familiarize yourself with all operating features and safety rules.

#### **This Fixed Base Router has the following features:**

1. Powerful, **12.0 Amp Soft Start Motor** develops **2 Peak HP** to handle most routing jobs.
2. **Variable-Speed Motor** runs at **10,000 to 25,000 RPM** (no-load speed).
3. **Speed Dial** allows matching proper speed to material and bit size.
4. **Electronic Feedback Circuitry** provides soft starts for longer motor life, maintains constant speed under load for a quality finish in all materials.
5. **Fixed Base features Coarse and Fine Depth Adjustments** for accurate set-ups. Ideal for use with a router table, sold separately.
6. **Spindle Lock** for easy 1-wrench bit changes. Includes **1/4 inch and 1/2 inch self-releasing collets/nuts** for use with a wide variety of 1/4 in. and 1/2 in. router bits, sold separately.

7. **100% Ball Bearings** for smooth, efficient operation and long life.
8. Base features **Ergonomically Designed Handles** for comfort and maximum control.
9. Base features **large Base Opening and large Chip Shield, combined with 3 LED Worklights** on the motor to provide high visibility of bit and workpiece.
10. **Durable Non-Marring Sub-Base** glides smoothly over the workpiece. The sub-base has a cutter-bit opening of 1-1/4 inches. Do not use a bit with a cutter diameter larger than 1-1/4 inches, as it will not pass through the sub-base opening.
11. **Base** constructed of **Die-Cast Aluminum** to provide durability and stability.
12. **Motor housing** constructed of **High Density Nylon** and **Precision Milled Cast Aluminum** for strength and exact fit into base.
13. High-impact resistant **Motor Housing Top Cap and Handles on Base** help protect tool from damage.
14. Heavy-duty **Edge Guide** for most routing applications such as decorative edging, grooving, dadoing, slotting and straight edge planing/trimming.
15. Conveniently located **ON/OFF toggle switch**, side mounted for added visibility and easy access.
16. **Vacuum Port** allows the base to attach a to 1-1/4 inch vac hose attachment, sold separately.
17. **“LIVE TOOL INDICATOR”** light is green when router is plugged into a power source. Light is located on motor housing top cap next to power cord inlet.
18. **Replaceable carbon brushes** (sold separately) for dependable service.
19. Includes **soft bag** for easy carrying and storage.

## OPERATION

**NOTE:** This tool is shipped completely assembled. To install or remove bits or add accessories such as vacuum ports for hook-up to vacs, see the following instructions.

### SELECTING THE CUTTER BIT

This router comes with 1/4 in. and 1/2 in. collets/nuts that accept cutter bits with 1/4 inch and 1/2 inch shanks, respectively.

**▲ WARNING:** Do not use a router cutter bit that has a cutter bit diameter larger than 1-1/4 inches with the sub-base that is installed on this router, as it will not fit through the sub-base opening, will cause damage to the sub-base and the motor, and could cause serious personal injury to the operator.

**NOTE:** The sub-base installed on this router has an opening of 1-1/4 inches. To use cutter bits with larger diameters, use sub-bases with larger openings, sold separately at Sears stores or other Craftsman outlets.

**⚠ WARNING:** Always turn the motor off and unplug the router before making any adjustments or installing accessories. Failure to unplug the router could result in accidental starting, which can cause serious personal injury.

## INSTALLING AND REMOVING THE CUTTER BIT (available separately) (Fig. 3, 4 and 4a)

### INSTALLING THE CUTTER BIT

1. Turn the motor off and unplug the router from the power source.
2. Remove the motor housing from the fixed base.

**NOTE:** See the instructions for installing and removing the motor housing from the fixed base on pages 17 and 18.

3. Set the motor upside down on its top cap, with the collet/nut pointing up.
4. Press the spindle-lock button to engage and lock the spindle shaft and collet/nut. (Fig. 3)
5. Place the wrench on the collet/nut and turn it counterclockwise to loosen the collet/nut slightly so that it can accept the cutter bit shank.
6. Insert the cutter bit shank into the collet/nut assembly as far as it will go, then back the shank out until the cutters are approximately 1/8 to 1/4 inch away from the face of the collet/nut. (Fig. 4, 4a)

**NOTE:** To ensure proper gripping of the cutter bit shank and minimize run-out, the shank of the cutter bit must be inserted into the collet/nut at least 5/8 inch.

7. With the cutter bit inserted and the spindle-lock button pressed in to engage the shaft, place the wrench on collet/nut and turn it clockwise until the collet/nut is firmly tightened on the cutter bit shank.

**⚠ WARNING:** Tighten the collet/nut securely to prevent the cutter bit from slipping. If the collet/nut is not securely tightened, the cutter bit may detach during use, causing serious personal injury.

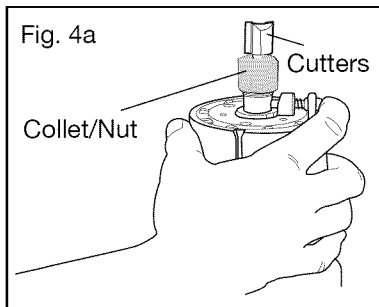
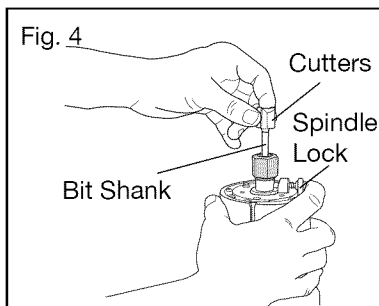
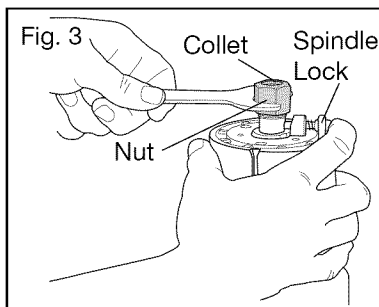

NOTE: To prevent damage to the tool, do not tighten the collet/nut without a cutter bit installed.

## REMOVING THE CUTTER BIT

1. Turn the motor off and unplug the router from the power source.
2. Remove the motor from the fixed base.

**NOTE:** See the instructions for installing and removing the motor housing from the fixed base on pages 17 and 18.

3. Set the motor upside down on its top cap, with collet/nut pointing up.
4. Press the spindle-lock button to engage and lock the spindle shaft and the collet/nut. (Fig. 3)
5. Place the wrench on the collet/nut and turn it counterclockwise to loosen the collet/nut slightly; remove the cutter bit shank.

## COLLET/NUT CARE

Before each use, inspect the collet/nut to make sure that it is clean and that it is gripping the cutter bit properly.

With the router cutter bit removed, press the spindle lock and turn the collet/nut counterclockwise until it is free from the motor spindle shaft. Blow the collet out with compressed air, and clean the tapered inside of the collet/nut with a tissue or a fine brush.

**⚠ WARNING:** Always wear safety goggles or safety glasses with side shields during power tool operations, or when blowing dust. If operation is dusty, also wear a dust mask.

Always make sure that the cutter bit shank, collet/nut and motor spindle are clean and free of woodchips, dust, residue, grease and rust before installing a cutter bit or collet/nut.

Apply a slight amount of machine oil to the spindle shaft if it looks dry.

Replace a worn or damaged collet/nut immediately.

**NOTE:** The collet/nut is self-releasing; it is not necessary to strike the collet/nut to free the router cutter bit. If the cutter bit seems to be stuck after use, loosen collet/nut a little more until it releases.

## CUTTER BITS

For faster, more accurate cutting results, keep cutter bits clean and sharpen only the inside of the cutting edges. Remove all accumulated pitch and gum from cutter bits after each use.

When sharpening cutter bits, sharpen only the inside of the cutting edge. Never grind the outside diameter. Be sure, when sharpening the end of a cutter bit, to grind so that the clearance angle the is same as originally ground.



## INSTALLING THE ROUTER MOTOR IN THE BASE (Fig. 5)

**⚠ WARNING:** Never use the router motor without installing it into either an approved fixed or plunge base. Failure to do so could result in serious personal injury and damage to motor.

**NOTE:** Before installing the motor housing in the fixed base, have the collet/nut and router cutter bit you are going to use already installed in motor housing. See “INSTALLING AND REMOVING THE CUTTER BIT”.

**⚠ WARNING:** Always turn the motor off and unplug the router from the power source before making any adjustments or installing accessories. Failure to turn the motor off and unplug the router could result in accidental starting, which can cause serious personal injury.

1. Turn the motor off and unplug the router from the power source.
2. Place the fixed base on a flat surface.
3. With the back of the fixed base facing you, open the motor clamp (A).
4. Press in Coarse Adjustment Knob (B) while you align the router motor key strip slot (C) with the key strip (D) in the fixed base.
5. When the motor's slot is aligned and engaged into the base's slot, slide the motor down into the fixed base.
6. The motor will now slide up or down to set coarse adjustments when the coarse adjustment knob is pressed in.
7. After all adjustments are made, close the motor clamp securely.

## REMOVING THE MOTOR FROM THE BASE (Fig. 5)

**⚠ WARNING:** Always turn the motor off and unplug the router from the power source before making any adjustments or installing accessories. Failure to turn the motor off and unplug the router could result in accidental starting, which can cause serious personal injury.

1. Turn the motor off and unplug the router from the power source.
2. Place the router (fixed base and motor housing) on a flat surface.
3. With the back of the router facing you, open the motor clamp (A).
4. Press in Coarse Adjustment Knob (B) while you align the motor key strip slot (C) with the key strip (D) in the fixed base.

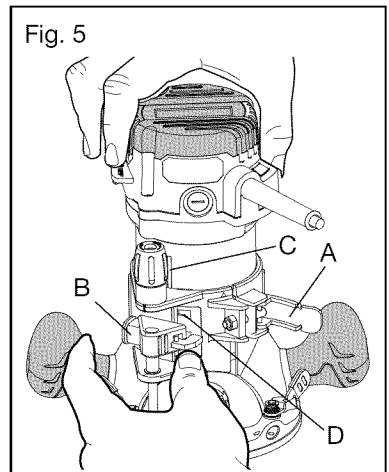

5. Set the motor upside down on its top cap with the collet pointing up and remove the cutter bit.

**⚠ WARNING:** Always remove the cutter bit from collet/nut when the router is not being used. Leaving bits installed could result in accidents causing serious personal injury.

## **ADJUSTING THE DEPTH OF CUT**

**⚠ WARNING:** Your router should never be turned on or be connected to the power source when you are assembling parts, making adjustments, installing or removing collets/nuts, cutter bits, cleaning the product or when it is not in use. Disconnecting the router will prevent accidental starting, which could cause serious personal injury.

**NOTE:** All depth adjustments on the fixed base must be made with the motor clamp open.

**NOTE:** For all fixed base routers, the cutter bit depth equals the amount of the cutter that is exposed below the surface of the sub-base.

The fixed base is designed with a fine adjustment worm-gear system. When the bit is lowered to the approximate position desired (coarse setting), the system then can be micro-adjusted to the precise depth.

### **Coarse Adjustment:**

Depressing the coarse adjustment knob (B) allows you to quickly lower or raise the cutter bit to an approximate depth setting.

### **Micro Adjustments:**

**NOTE:** Be sure that the worm gear system is engaged before making fine adjustments. Test it by turning the fine adjustment dial (C) clockwise and counter-clockwise to see if the bit lowers and raises. If it does not, press in the coarse adjustment knob and turn the fine adjustment dial until the gears engage, then reset zero "0" on depth indicator ring (D).

The depth indicator ring (D) located on the fine adjustment dial is marked in 1/64-inch increments. Turning the fine adjustment dial clockwise 180°(1/2 turn), lowers the cutter bit 1/16 inch. One full turn clockwise (360°) lowers the bit 1/8 inch.

The system allows a maximum of 7 full 360° revolutions, clockwise, to lower the cutter bit a total of 7/8 inch.

The depth indicator ring may be reset to zero "0" without moving the fine adjustment dial. This allows the user to begin adjustments from any reference point desired.

### **To Adjust Depth (Figs. 6 and 6a)**

1. Turn the motor off and unplug the router from the power source.
2. Place the router on a flat, level surface with the back of the fixed base facing you.

3. Open the motor clamp (A).
5. With the cutter bit already installed, press in the coarse adjustment knob (B), and lower the motor into the base until the cutter bit is very close to the flat surface on which the base is sitting. Turn the fine adjustment dial (C) until the cutter bit just touches the flat surface on which the base is sitting. Lock motor clamp (A).
6. While continuing to press the coarse adjustment knob (B), turn the fine adjustment dial (C) until zero "0" is aligned with the "I" mark on the base.
7. Release the coarse adjustment knob, making sure that the "0" remains aligned with the mark.
8. Place the router on two level scrap workpieces and position it so that the cutter bit can be lowered below the sub-base. (Fig. 6a).
10. Turn the fine adjustment dial (C) clockwise to lower the bit to the desired depth of cut. Turn the dial counter-clockwise to raise the cutter bit.
11. Once your depth of cut is set, close the motor clamp (A) securely.

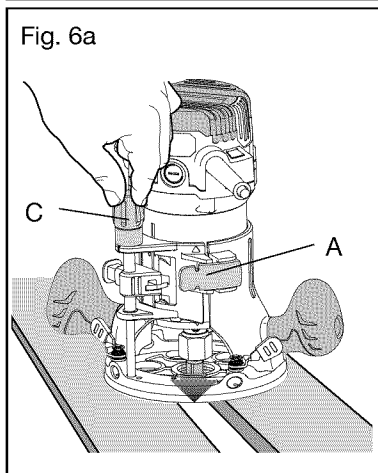
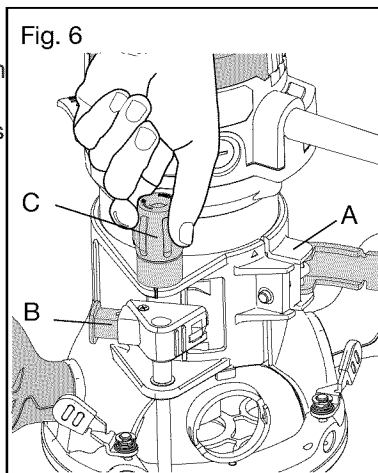

**NOTE:** Making a single deep cut is never advisable. Smaller diameter cutter bits are easily broken by too much side thrust and torque. Larger cutter bits will cause a rough cut and be difficult to guide and control. For these reasons, do not exceed 1/8 in. depth of cut in a single pass.

### TOGGLE "ON/OFF" SWITCH (Fig. 7)

Use the toggle switch located on the top cap of the motor housing to turn the router "ON" and "OFF".

The left side of the toggle switch hood (as you face it) is marked "I" for "On" and the right side (as you face it) is marked "O" for "Off". To turn the motor "ON", push the toggle switch to the left side marked "I", or "On". To turn the motor "OFF" push the toggle switch to the right side marked "O", or "Off".

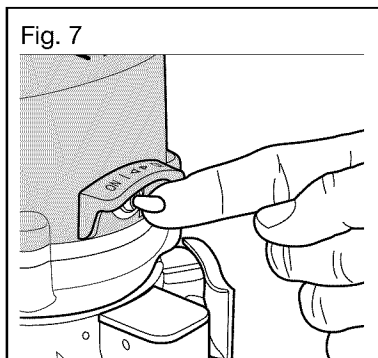

Contact the workpiece with the router and cutter bit only after the router has reached full speed. Turn the router motor “OFF” and allow the cutter bit to come to a complete stop before removing the router and cutter bit from the workpiece.

### **SOFT START FEATURE**

The soft start feature minimizes torque twist, customary in larger router motors, by limiting the speed at which the motor starts. This increases the motor’s life.

### **ELECTRONIC FEEDBACK CONTROL**

The electronic feedback control maintains a constant speed under load to provide a smooth finish.

### **LED WORKLIGHTS (Fig. 8)**

Your router motor has 3 built-in worklights located around the collet/nut to provide high visibility of workpiece when cutting. These lights are always “On” when the toggle switch is in the “On” position.

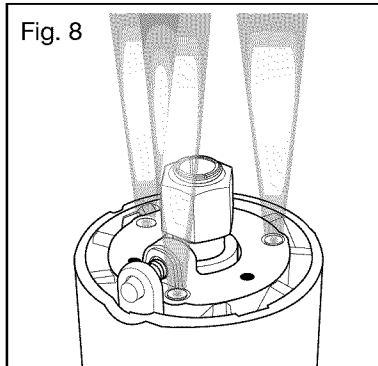

### **“LIVE TOOL INDICATOR” LIGHT (Fig. 9)**

Your router also has a “Live Tool Indicator” green light, located on the motor housing top cap where the power cord enters the motor housing. This green light is always on when router motor is plugged into power source.

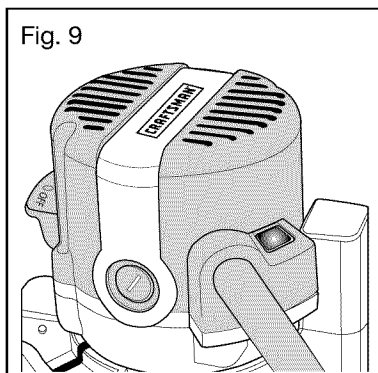

### **HEAVY-DUTY EDGE GUIDE (Fig.10)**

The Fixed-Base Router comes with a heavy-duty edge guide. This edge guide can be used as an aid in routing applications such as decorative edging, straight edge planning and trimming, grooving, dadoing and slotting.

To attach the edge guide to the fixed base, simply insert the edge guide rods into edge-guide mounting slots either from the left or the right.

Tighten the lever on the left by turning it clockwise to secure the edge guide rod (Fig.10). Tighten the lever on right by turning counterclockwise to secure the rod (Fig.10).

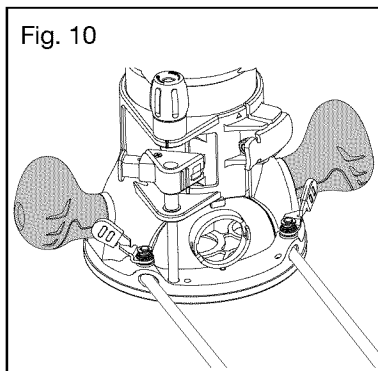

**NOTE:** If the inner screws wear down or require calibration:

- Pull the lever up and turn it clockwise and then push the lever down (Fig.10a).
- Turn the lever counterclockwise to secure the edge guide (Fig.10b).

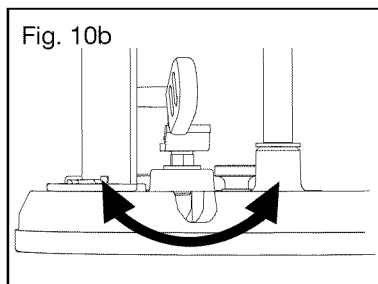
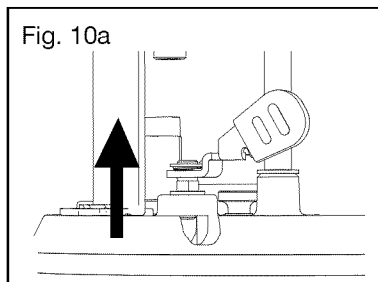

### Electronic Variable Speed Control

The electronic variable speed control feature allows the router motor speed to be matched to cutter size and material hardness for an improved finish and extended bit life.

Speed changes are made starting at “1” by rotating the Speed Control Dial to the “LEFT” to increase the speed, and to the “RIGHT” to decrease the speed as indicated on the Dial, numbered 1 through 6. The speed may be changed while the router is “ON”, but do not change the speed when the cutter bit is contacting the workpiece.

**▲ WARNING:** Do not change the speed when the cutter bit is contacting the workpiece, as this will cause excessive vibration.

Your router motor top cap has a “Variable Speed Selection Chart” located above the “ON/OFF” toggle switch to help you determine the correct speed for the cutter bit being used.

**▲ WARNING:** Before operating your router follow all safety instructions in this manual. Failure to do so could result in serious personal injury.

Variable Speed Selection Chart	
Never exceed these bit speeds	
Cutting-Bit Diameter	Max.Speed
UP to 1in.(25mm)	6
1 1/4-in. to 2-in. (30-50mm)	4-5
2 1/4-in. to 2 1/2-in. (55-65 mm)	2-3
3-in. to 3 1/2-in. (75-90mm)	1-2

Reduce the speed when using extra large bits (cutting diameter of 1 inch or greater), or heavy cutter bits. Changing the rate of feed can also improve the quality of the cut.

DIAL SETTING	RPM	APPLICATION
1	10,000	Non-ferrous metal, hardwoods, larger diameter cutter bits
2	13,000	
3	16,000	
4	19,000	Softwoods, plastics, countertops, smaller diameter cutter bits
5	22,000	
6	25,000	

The speed charts above indicate the relationship between speed settings and the cutting application. Exact settings are determined by operator experience and reference, and also by recommendations made by manufacturers of cutter bits.

## PLACING THE ROUTER ONTO THE WORKPIECE AND STARTING THE CUT

**▲ WARNING:** Before operating the router follow all safety instructions in this manual. Failure to do so could result in serious personal injury.

**NOTE:** Making test cuts is essential with most routing applications. A test cut will give a feel for the set-up, the router's speed, the depth of cut, and how the cutter bit reacts to the workpiece.

Much of routing is a trial-and-error process of making various adjustments, followed by test cuts. To avoid ruining good material, make your test cuts on scrap materials.

How you place your router onto a workpiece (starting the cut) with a fixed base depends on the type of routing you are going to produce: edge routing or internal routing, as discussed on the following pages.

For ease of operation and to maintain proper control, your router has two handles: one on each side of the router base. When operating the router, always hold it firmly with both hands (Fig. 11).

**▲ WARNING:** Always be alert and watch what you are doing. Never operate the router when you are fatigued.

## DEEP CUTS

The proper cutting depth for each pass is always determined by the material, the cutter bit size and type, and power of the motor.

Always make several progressively deeper cuts: start at one depth and then make several passes, each time increasing the cutting depth, until your desired depth is reached.

Making a cut that is too deep will stress the router motor and the cutter bit, and it may burn the workpiece and dull the cutter bit. It could also "grab" too much of the workpiece and cause you to lose of control of the router, causing a serious accident.

To be certain that your depth settings are correct, always make test cuts in scrap material similar to your workpiece before beginning the final cutting operation.

Remember, knowing the right depth for each cut comes with routing experience.

### EDGE ROUTING (Fig. 11)

1. With the depth-of-cut set, place the router on the edge of workpiece, making sure that the cutter does not contact the workpiece.
2. Clamp an edge guide (board or metal straightedge) in place to help guide the router base.
3. Turn the router "On", and allow the motor build to its full speed.
4. To begin your cut, gradually feed the cutter bit into the edge of the workpiece.
5. When the cut is complete, turn motor "Off" and allow cutter bit come to a complete stop before removing it from the workpiece.
6. Unplug the router from the power source, and inspect the finished cut in the workpiece.

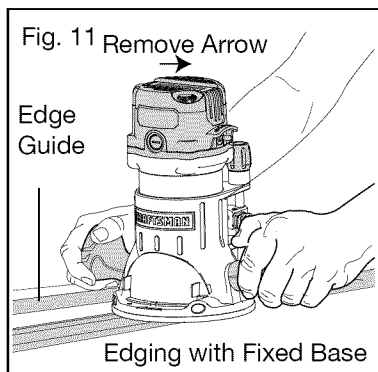

**⚠ WARNING:** Always securely clamp your workpiece and keep a firm grip on the router base with both hands at all times. Failure to do so could result in loss of control, causing possibly serious personal injury.

**⚠ WARNING:** Removing the cutter bit from the workpiece while it is still rotating could damage the workpiece and result in loss of control, causing serious personal injury.

**NOTE:** Making test cuts in scrap material that is similar to your workpiece is essential. Learning how the router's speed, depth-of-cut and cutter bit will react in the workpiece will help you produce quality cuts.

### INTERNAL ROUTING (Figs. 12, 12a, 12b and 13)

1. With the depth-of-cut set, tilt the router and place it on the workpiece with only the leading edge of the sub-base contacting the workpiece (Fig. 12).
2. Turn the motor "On" and allow motor build up to its full speed, being careful not to let the cutter bit contact workpiece.

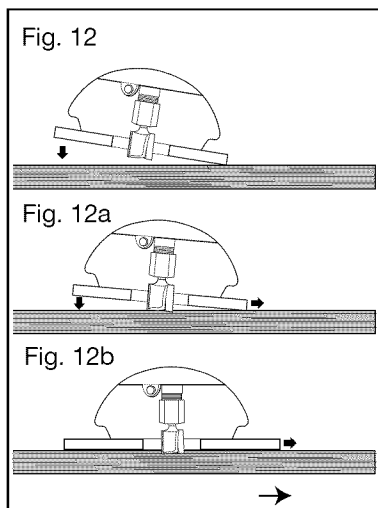

3. To begin your cut, gradually lower the cutter bit into the workpiece until the sub-base is flush with the workpiece (see Fig. 12a, 12b).
4. When the cut is completed, turn the motor “Off” and allow the cutter bit come to a complete stop before removing it from the workpiece.
5. Unplug the router from the power source, place the router upside down on the worktable, and inspect the finished cut in the workpiece.

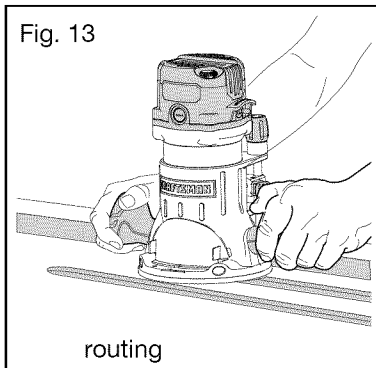

**▲ WARNING:** Always securely clamp your workpiece and keep a firm grip on the router base with both hands at all times. Failure to do so could result in loss of control, causing possible serious personal injury. If using a router table, large cutter bits should be used for edging only.

**▲ WARNING:** Removing the cutter bit from the workpiece while it is still rotating could damage the workpiece and result in loss of control, causing serious personal injury.

#### **FREEHAND ROUTING WITH THE FIXED BASE (Fig.14)**

**▲ WARNING:** Do not use large cutter bits for freehand routing. Use of large cutter bits when freehand routing could cause loss of control or create other hazardous conditions that could result in personal injury. If using a router table, large bits should be used for edging only.

When used freehand, the router becomes a flexible and versatile tool. This flexibility makes it possible to easily rout signs, relief sculptures, etc.

When freehand routing:

1. Draw or lay out the pattern on the workpiece.
2. Choose the appropriate bit.
3. Follow the instructions for INTERNAL ROUTING, and rout the pattern in two or more passes. Do not exceed 1/8-in. depth of cut in a single pass. This will help provide better control, as well as serve as a guide on the next passes.

**NOTE:** A core-box bit or V-groove bit is often used for routing letters and engraving objects. Straight bits and ball mills are often used to make relief carvings. Veining bits are used to carve small, intricate details.

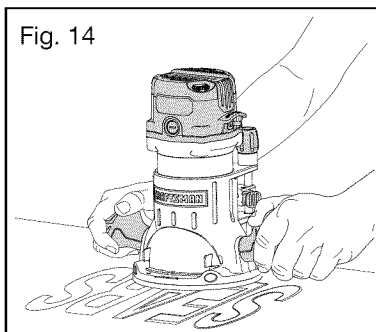



**NOTE:** Making a single deep cut is never advisable. Smaller-diameter bits are easily broken by too much side thrust and torque. Larger bits will cause a rough cut and be difficult to guide and control. For these reasons, do not exceed 1/8-in. depth of cut in a single pass.

**▲ WARNING:** Always securely clamp your workpiece in place, and keep a firm grip on the router base with both hands at all times. Failure to do so could result in loss of control causing possible serious personal injury.

### EDGING WITH A PILOT BIT (Figs.15 and 15a)

The arbor-type bits with pilots are excellent for edge shaping any workpiece edge that is straight, or is curved at a curvature equal to or greater than the radius of the bit to be used.

The pilot prevents the bit from making an excessively deep cut, and holding the pilot firmly in contact with the workpiece edge throughout prevents the cut from becoming too shallow.

#### Top Edge Shaping

Whenever the workpiece thickness, together with the desired depth of cut (as adjusted by router depth setting) are such that only the top part of the edge is to be shaped (leaving at least a 1/16 in. thick uncut portion at the bottom), the pilot can ride against the uncut portion, which serves to guide it. (Fig.15)

#### Whole Edge Shaping

If the workpiece is too thin or the bit is set so low that there will be no uncut edge against which to ride the pilot, an extra board must be placed under the workpiece to act as a guide (Fig.15a). This “guide” board must have exactly the same contour—“straight or curved” --as the workpiece edge. If it is positioned so that its edge is flush with the workpiece edge, the bit will make a full cut (in as far as the bit radius). On the other hand, if the guide is positioned (out from the workpiece edge), the bit will make less than a full cut---which will alter the shape of the finished edge.

**NOTE:** The size (diameter) of the pilot that is used determines the maximum cut width that can be made with the pilot against the workpiece edge (the small pilot exposes all of the bits; the large one reduces this amount by 1/16 in.). Any of the piloted cutter bits can be used without a pilot for edge shaping with guides.

**▲ WARNING:** Always securely clamp your workpiece and keep a firm grip on the router base with both hands at all times. Failure to do so could result in loss of control causing possible serious personal injury.

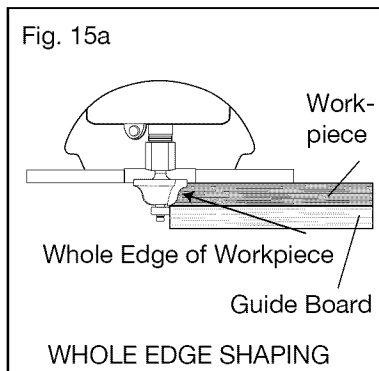
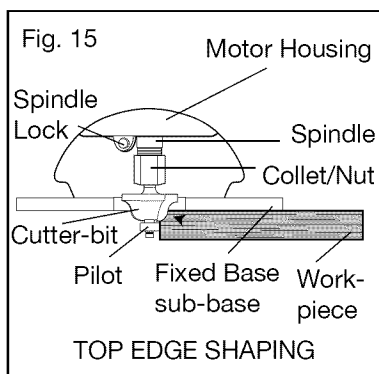

## FEEDING THE ROUTER (Fig. 16)

The secrets to professional routing are a careful set-up for the cut, selecting the proper depth of cut, knowing how the cutter bit reacts in your workpiece, and the rate and direction of feed of the router.

### DIRECTION OF FEED-- EXTERNAL CUTS (Fig. 16)

The cutter bit rotates clockwise. Feeding the bit from left to right will cause the bit to pull the router towards the workpiece (see Fig. 16). If the router is

fed in the opposite direction (right to left), the rotating force of the cutter bit will tend to throw the bit away from the workpiece. This is called “Climb-Cutting.” “Climb-Cutting” may cause loss of control, possibly resulting in personal injury. When “Climb-Cutting” is required (e.g., backing around a corner), exercise extreme caution to maintain control of the router.

The high speed of the cutter bit during a proper feeding operation (left to right), results in very little kickback under normal conditions. However, if the cutter bit strikes a knot, an area of hard grain, or a foreign object, “Kickback” may result. Kickback may damage your workpiece and could cause you to lose control of the router, possibly causing personal injury. Kickback is always in the opposite direction of the clockwise cutter bit rotation, or counterclockwise.

**To guard against and help prevent Kickback**, plan your set-up and direction of feed so that you’re always keeping the sharp edges of the cutter bit biting straight into uncut wood. Always inspect your workpiece for knots, hard grain, and foreign objects.

**⚠ WARNING:** Kickback causes the power tool to jerk back toward the user, causing possible loss of control and serious injury. Always take precautions against kickback as described in the operator’s manual.

### DIRECTION OF FEED - INTERNAL CUTS (Figs.17 and 17a)

When making an internal cut, such as a groove, dado, or slot, always have the guide you are using with the router (edge guide, straight edge, or board guide) on the right-hand side of the router as you make the cut. (Fig.17)

When the guide is positioned on the right hand side of the router, the router travel should be from left to right and “counterclockwise” around curves (see Fig. 17). This counterclockwise action around the curve could cause “Climb cutting”. Always be alert and exercise extreme caution to maintain control of the router when making this type of cut around curves.

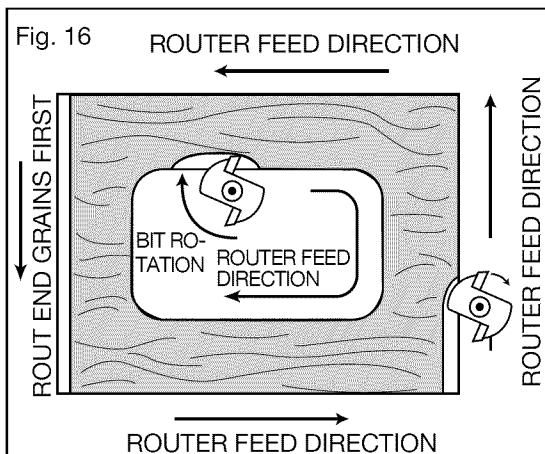

When the guide is positioned as shown in Fig. 17a, the router travel should be from left to right and clockwise around curves.

If there is a choice, the set-up in Fig. 17 is easier to use, but there is the possibility of “Climb Cutting” around curves. In either case, Fig. 17 or Fig. 17a, the sideways thrust of the router cutting is always against the guide, as is proper.

**⚠ WARNING:** Always securely clamp the workpiece in place, and keep a firm grip on the router base with both hands at all times. Failure to do so could result in loss of control causing possible serious personal injury.

### RATE OF FEED (Figs. 18 and 18a)

The proper rate of feed depends on several factors: the hardness and moisture content of the workpiece, the depth of cut, and the cutting diameter of the bit. When cutting shallow grooves in soft woods such as pine, you may use a faster rate of feed. When making deep cuts in hardwoods such as oak, you should use a slower rate of feed.

### FEEDING TOO FAST (Fig. 18)

Clean and smooth cuts can only be achieved when the cutter bit is rotating at a relatively high speed, taking very small bites and producing tiny, clean cut chips.

Forcing the feed of the cutter bit forward too rapidly slows the rotation speed of the cutter bit, and the bit takes larger bites as it rotates. Bigger bites mean bigger chips and a rough finish. This forcing action can also cause the router motor to overheat.

Under extreme force-feeding conditions, the rotations can become so slow and the bites become so large that chips become partially cut off, causing splintering and gouging of the workpiece.

The router will make clean, smooth cuts if it is allowed to run freely without the overload of forced feeding. You can detect forced feeding

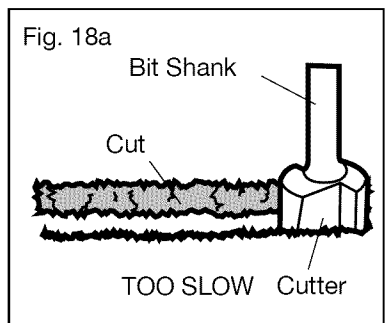
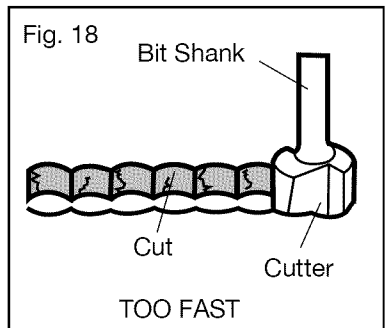
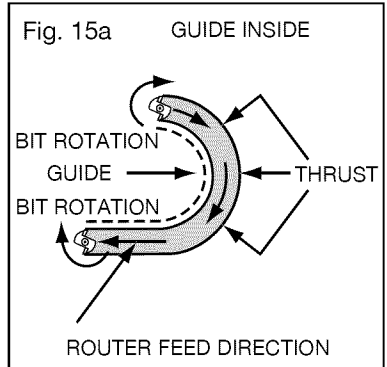
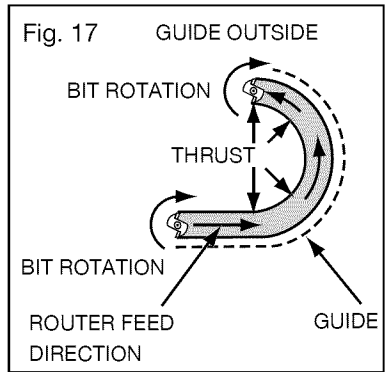

by the sound of the motor. Its usual high-pitched whine will sound lower and stronger as it loses speed. Holding the router against the workpiece will also come more difficult.

### FEEDING TOO SLOWLY (Fig. 18a)

When you feed the cutter bit too slowly, the rotating cutter bit does not cut into new wood rapidly enough to take a bite. Instead, it scrapes away sawdust-like particles. This scraping produces heat, which can glaze, burn, and mar the cut in the workpiece and, in extreme cases, overheat the cutter bit.

When the cutter bit is scraping instead of cutting, the router is more difficult to control as you feed it.

With the reduced load on the motor caused by the slow feed, the cutter bit has a tendency to bounce off the sides of the cut in the workpiece, producing a cut with a rippled finish instead of clean straight sides.

### CHIP SHIELD (Fig. 19)

**▲ WARNING:** Always wear eye protection. The chip shield is not intended as a safety guard.

To remove the chip shield from the fixed base, press inward on the tabs until the chip shield releases from base and then remove the chip shield. To attach, place the chip shield back in position and flex the sides while pushing in the shield until it snaps back into place (Fig. 19).

**▲ WARNING:** The chip shield helps to keep dust and chips away from the operator; it will not stop objects larger than woodchips thrown from the bit.

**▲ CAUTION:** Always have the chip shield in place on the base when operating the router.

**▲ WARNING:** Always turn the motor off and unplug the router from the power source before making any adjustments or installing accessories. Failure to turn the motor off and unplug router could result in accidental starting which can cause serious personal injury.

### DUST COLLECTION WITH VAC ADAPTER (Fig. 20)

**The vac adapter is sized to accept a 1-1/4 in. vac hose, sold separately.**

To attach the vacuum port onto the fixed base, align the two tabs on the port with the two slots on the port at back of the base, and secure it by turning it clockwise (Fig.20)

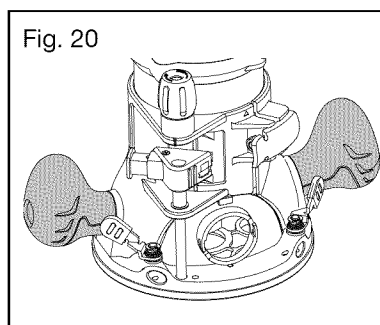
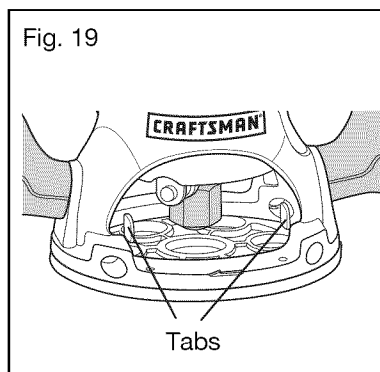

## TO ADJUST DEPTH WITH DEPTH-ADJUSTMENT WRENCH (Figs. 21, 21a)

**NOTE:** The Depth-Adjustment Wrench supplied is used to adjust the depth when the router is fixed to the router table (Model No. 320. 28180), sold separately (Fig. 21).

**⚠ WARNING:** Always read and follow all directions for mounting the router to a router table and for use of the router table.

**⚠ WARNING:** Always turn the router motor off and unplug the router from the power source before making any adjustments or installing accessories. Failure to turn the router motor off and unplug the router could result in accidental starting, which can cause serious personal injury.

**⚠ WARNING:** Only use router tables with proper guarding for the cutting bit and with “on-board,” switch-controlled receptacles. Failure to use router tables with appropriate safety features could result in serious personal injury.

When using the fixed base to attach the router to the router table, the bit depth can be adjusted by turning the Micro Adjustment Dial clockwise or counterclockwise with the wrench supplied. (Fig. 21a) The depth of the cut can be read on the scale dial. Each mark on the scale indicates a 1/64-in. change in depth setting.

1. Turn off the router.
2. Loosen the router motor clamp.
3. Insert the wrench into the adjusting hole on the tabletop. Turn the adjustment bolt on the router clockwise with the wrench to move the collet/nut up, or counterclockwise to move the collet/nut down.
4. When the desired depth of cut is set, tighten the router motor clamp. The precise depth of cut can be measured with a ruler.

Fig. 21

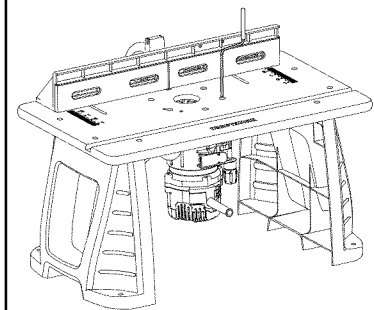
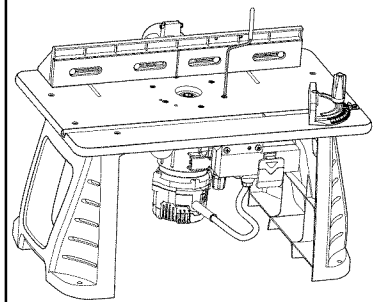

Fig. 21a



## MAINTENANCE

**⚠ WARNING:** To ensure safety and reliability, all repairs should be performed by a qualified service technician at a Sears Service Center.

### GENERAL

Only the parts shown on the parts list are intended for repair or replacement by the customer. All other parts represent an important part of the double-insulation system and should be serviced only by a qualified Craftsman service technician.

**⚠ WARNING:** For your safety, always turn off the switch and unplug the router motor from the power source before performing any maintenance or cleaning.

It has been found that electric tools are subject to accelerated wear and possible premature failure when they are used to work on fiberglass, wallboard, spackling compounds or plaster. The chips and grindings from these materials are highly abrasive to electrical tool parts, such as bearings, brushes, commutators, etc. Consequently, it is not recommended that this tool be used for extended work on any fiberglass material, wallboard, spackling compound, or plaster. During any use on these materials, it is extremely important that the tool is cleaned frequently by blowing with an air jet.

**⚠ WARNING:** Always wear safety goggles or safety glasses with side shields during power tool operations, or when blowing dust. If operation is dusty, also wear a dust mask.

### ROUTINE MAINTENANCE

**⚠ WARNING:** Do not at any time allow brake fluids, gasoline, petroleum-based products, penetrating oils, etc. to come in contact with plastic parts. Chemicals can damage, weaken, or destroy plastic, which may result in serious personal injury.

1. When work has been completed, clean the tool to allow smooth functioning of the tool over time.
2. Use clean, damp cloths to wipe the tool.
3. Check the state of all electrical cables.
4. Keep the motor air openings free from oil, grease, and sawdust or woodchips, and store the tool in a dry place.
5. Be certain that all moving parts are well lubricated, particularly after lengthy exposure to damp and/or dirty conditions.

**⚠ WARNING:** For your safety, always turn off the switch and unplug the router motor from the power source before performing any maintenance or cleaning.

Refer to “Collet/Nut Care and Cutter Bits” for cleaning care.

## REPLACEMENT OF CARBON BRUSHES (Fig. 22)

Replacement brush sets are available through Sears Parts and Repair Centers.

1. Unplug the router motor before inspecting or replacing brushes.
2. Replace both carbon brushes when either has less than 1/4-in. length of carbon remaining, or if the spring or wire is damaged or burned.
3. Using a slotted screwdriver, remove the black, plastic cap on each side of the router motor (Fig. 22) and carefully withdraw the spring-loaded brush assemblies. Keep brushes clean and sliding freely in their guide channels.

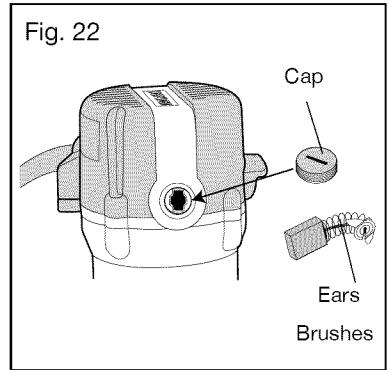

**NOTE:** To reinstall the same brushes, make sure that the brushes go back in the same way they came out. This will avoid the need for a break-in period.

4. Insert new brush assemblies into the guide channels with the carbon part going in first, being certain to fit the two metal “ears” into their slots in the channel (Fig. 22).
5. Remember to replace both end caps after inspecting or servicing brushes. Tighten the caps snugly, but do not over-tighten. The router should be allowed to “run in” (run at no load without a cutter bit) for 5 minutes before use, to seat the new brushes properly.

**⚠ WARNING:** For your safety, always turn off the switch and unplug the router motor from the power source before performing any maintenance or cleaning.

## LUBRICATION

All of the bearings in this tool are lubricated with a sufficient amount of high-grade lubricant for the life of the tool under normal operating conditions. Therefore, no further lubrication is required.

## TROUBLESHOOTING

PROBLEM	CAUSE	SOLUTION
The router does not work	Plug is not plugged into the power source.	Plug the cord into the power source.
	Switch is in "OFF" position.	Put the switch to "ON" position.
	The carbon brushes have worn out completely.	Remove the brush caps, and replace the old brushes with new ones.
The surface of the workpiece is not smooth after cutting	The bit is dull.	Change to a sharp bit.
	Routing at an inappropriate bit speed	Select an appropriate bit speed.
Bit can not be installed	Bit size is inappropriate for the collet/nut	Use 1/4-in shaft bits with the 1/4-inch collet; use 1/2-in shaft bits with the 1/2-inch collet.

## ACCESSORIES

















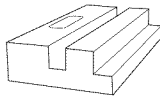



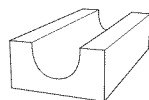

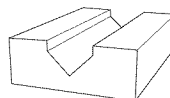

**⚠ WARNING:** The use of attachments or accessories that are not recommended for this tool might be dangerous and could result in serious injury. Sears and other Craftsman outlets offer a large selection of Craftsman router accessories designed for specific routing applications.

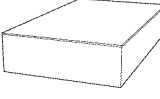

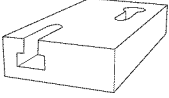
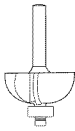
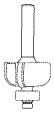



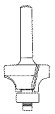

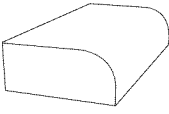

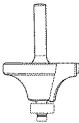
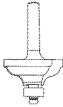
There is a large selection of Craftsman Router Cutting bits available in High-Speed Steel or Carbide Tipped High-Speed Steel for all your routing needs.

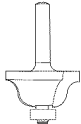
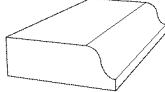
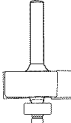
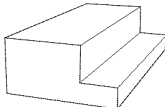
In addition to a wide variety of router bits, Sears also offers accessories such as: Router tables, various template sets, universal router fence with lock knobs (64181), 11 pc. bushing set (64180) and clear sub-base sets; 6pc. fixed base (64182); 6 pc. plunge base (64183).

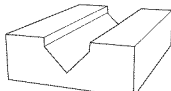
**⚠ WARNING:** Only use router tables with proper guarding for the cutting bit and with "on-board" switch-controlled receptacles. Failure to use router tables with appropriate safety features could result in serious personal injury.

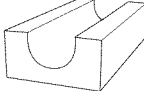

<p>1/8-in. straight</p>  <p>5/16-in. straight</p>  <p>3/8-in. straight</p>  <p>1/2-in. straight</p>  <p>1/4-in. straight</p>  <p>3/4-in. straight</p> 	<p>straight</p> 
<p>3/8-in. dove tail</p>  <p>1/2-in. dove tail</p> 	<p>dovetail</p> 
<p>1/2-in. round nose</p> 	<p>round nose</p> 
<p>1/2-in. 90 d v groove</p> 	<p>v groove</p> 
<p>1/2 x 1-in. flush trim</p>  <p>1/2-in. flush trim</p>  <p>3/8x1/2-in. flush trim</p>  <p>1/4-in. flush trim</p> 	<p>flush trim</p> 
<p>3/8-in. keyhole</p> 	<p>keyhole</p> 
<p>1/2-in. cove</p>  <p>1/4-in. cove</p> 	<p>cove</p> 
<p>3/8-in. round over</p>  <p>1/8-in. round over</p>  <p>1/4-in. round over</p>  <p>1/2-in. round over</p> 	<p>round over</p> 

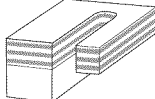
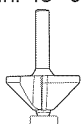
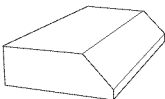
<p>1/2-in. bead and cove</p>  <p>1/16-in. classic cove with bead</p> 	 bead cove  classic cove & bead
<p>1/4-in. roman ogee</p> 	<p>Roman ogee</p> 
<p>3/8-in. rabbeting</p> 	<p>rabbeting</p> 
<p>1/4-in. veining</p> 	<p>veining</p> 
<p>1/2-in. core box</p> 	<p>core box</p> 
<p>1/2-in. mortising</p> 	<p>mortising</p> 
<p>1/4-in. panel pilot</p> 	<p>panel pilot</p> 
<p>1-3/8-in. 45° chamfer</p> 	<p>chamfer</p> 

# PARTS LIST

## 12.0 Amp Fixed Base Router Model No. 320.2768

The Model Number will be found on the Nameplate attached to the motor unit .  
Always mention the Model Number when ordering parts for this tool.

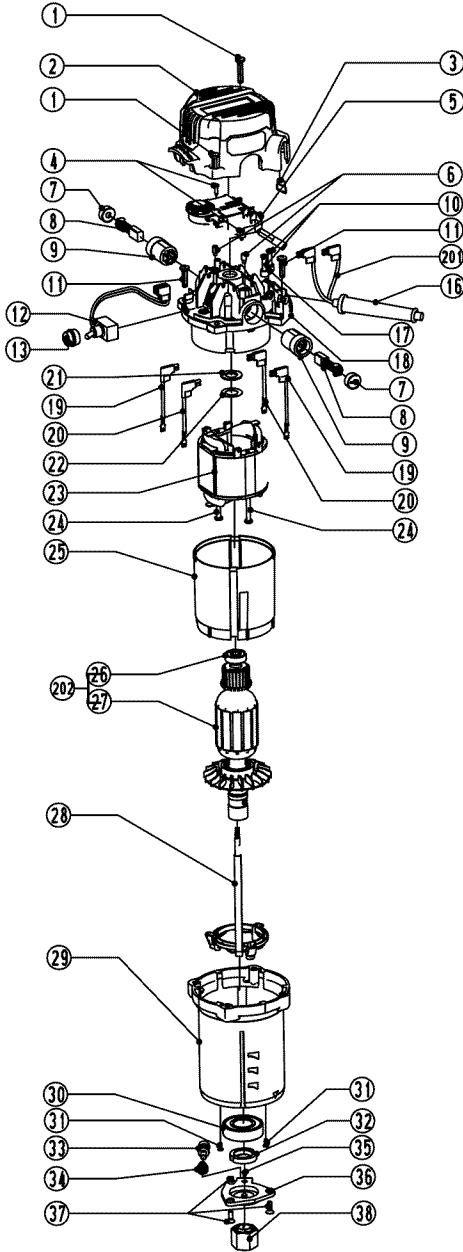

# PARTS LIST

## 12.0 Amp Fixed Base Router Model No. 320.2768

The Model Number will be found on the Nameplate attached to the motor unit .  
Always mention the Model Number when ordering parts for this tool.

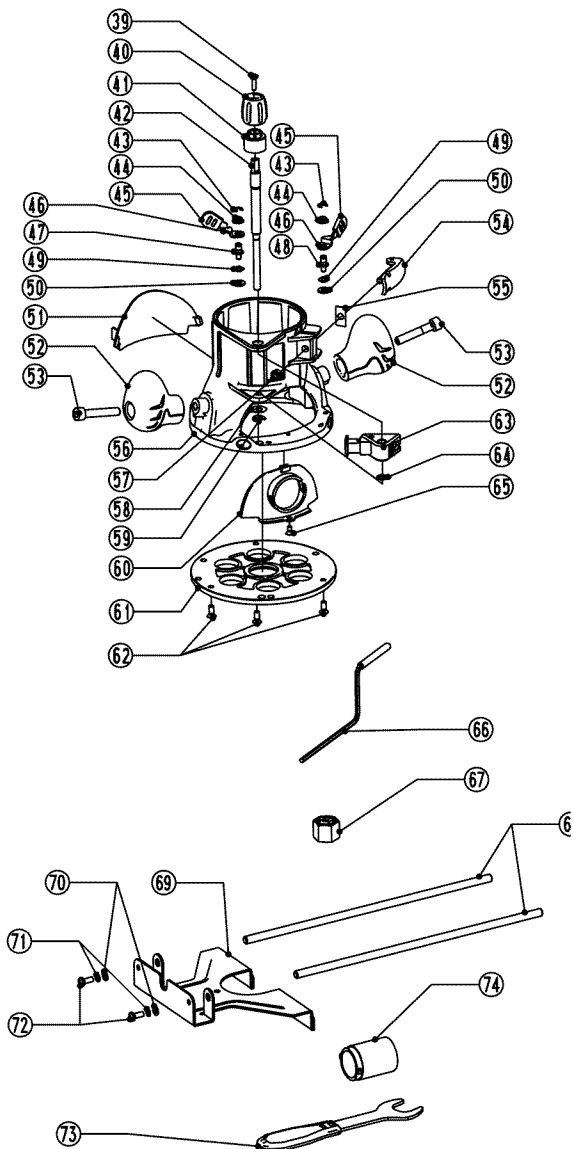

Explosive drawing

Back cover

## PARTS LIST

No	Part No	Part Name	QTY
1	5610220000	Screw	2
2	3321133000	Rear Cover	1
3	3121518000	Transparent Cap	1
4	5610017000	Tapping Screw	2
5	4890638000	Speed Adjustor	1
6	5620017000	Screw	2
7	3120537000	Brush Cover	2
8	4960019000	Carbon Brush Assy	2
9	2800005000	Brush Holder Assy	2
10	5610106000	Tapping Screw	2
11	5610059000	Screw	2
12	2823115000	Switch Assy	1
13	3122851000	Seal Ring	1
201	4810002000	Power Cord Assy	1
14	4930008000	Sleeve	2
15	4930038000	Receptacle	2
16	3121064000	Cord Guard	1
17	3122798000	Cord Anchorage	1
18	3125685000	Middle Housing	1
19	2822038000	Inner Wire Assy	2
20	2822039000	Inner Wire Assy	2
21	3121049000	Rubber Spring	1
22	3700249000	Washer	1
23	2740118000	Stator	1
24	5610049000	Tapping Screw	2
25	3125687000	Fan Baffle	1
202	2823131000	Rotor Assy	1
26	5700008000	Ball Bearing	1
27	2750184000	Rotor	1
28	2823021000	LED Holder Assy	1
29	3421186000	Motor Housing	1
30	5700056000	Ball Bearing	1
31	5610076000	Tapping Screw	2

## PARTS LIST

No	Part No	Part Name	QTY
32	5630179000	Nut	1
33	3551635000	Spindle Lock	1
34	3660174000	Stop Spring	1
35	5620061000	Screw	1
36	3421190000	Spindle Lock Cover	1
37	5620069000	Screw	3
38	2823121000	Collet Assembly	1
39	5620041000	Screw	1
40	3320460000	Adjusting Knob	1
41	3123281000	Indicator	1
42	3550841000	Shaft	1
43	5660005000	"E" Ring	4
44	3660498000	Spring	4
45	3126054000	Handle Sleeve	4
46	3705047000	Lever	4
47	5620466000	Screw	2
48	5620467000	Screw	2
49	5650407000	Wave Washer	4
50	5650166000	Washer	2
51	3121637000	Chip Shield	1
52	3121635000	Handle	4
53	5620024000	Screw	4
54	2823122000	Lever Assy	2
55	3703872000	Plate	1
56	2823126000	Mounting Assy	1
57	5630015000	Nut	2
58	5650050000	Washer	1
59	5660177000	"E" Ring	1
60	3123294000	Dust Bracket	1
61	3125119000	Base Plate	1
62	5620074000	Screw	3
63	2822272000	Adjusting Assy	1

## PARTS LIST

No	Part No	Part Name	QTY
64	5650337000	Washer	1
65	5620067000	Screw	1
66	3402220000	Depth Adjusting Lever	1
67	2823125000	Collet Assy	1
68	3550588000	Guiding Rod	2
69	3703925000	Fence	1
70	5650013000	Washer	2
71	5650015000	Spring Washer	2
72	5620050000	Screw	2
73	3402471000	Wrench	1
74	3123286000	Vaccum Adapter	1

# Get it fixed, at your home or ours!

## Your Home

For troubleshooting, product manuals and expert advice:



[www.managemylife.com](http://www.managemylife.com)

For repair – **in your home** – of **all** major brand appliances, lawn and garden equipment, or heating and cooling systems, **no matter who made it, no matter who sold it!**

For the replacement parts, accessories and owner's manuals that you need to do-it-yourself.

For Sears professional installation of home appliances and items like garage door openers and water heaters.

**1-800-4-MY-HOME®**

(1-800-469-4663)

[www.sears.com](http://www.sears.com)

Call anytime, day or night

(U.S.A. and Canada)

[www.sears.ca](http://www.sears.ca)

## Our Home

For repair of carry-in items like vacuums, lawn equipment, and electronics, call anytime for the location of the nearest

### Sears Parts & Repair Service Center

**1-800-488-1222** (U.S.A.)

[www.sears.com](http://www.sears.com)

**1-800-469-4663** (Canada)

[www.sears.ca](http://www.sears.ca)

To purchase a protection agreement on a product serviced by Sears:

**1-800-827-6655** (U.S.A.)

**1-800-361-6665** (Canada)

Para pedir servicio de reparación a domicilio, y para ordenar piezas:

**1-888-SU-HOGAR®**

(1-888-784-6427)

[www.sears.com](http://www.sears.com)

Au Canada pour service en français:

**1-800-LE-FOYER<sup>MC</sup>**

(1-800-533-6937)

[www.sears.ca](http://www.sears.ca)

# Sears

© Registered Trademark / <sup>TM</sup> Trademark of KCD IP, LLC in the United States, or Sears Brands, LLC in other countries

© Marca Registrada / <sup>TM</sup> Marca de Fábrica de KCD IP, LLC en Estados Unidos, o Sears Brands, LLC in otros países

<sup>MC</sup> Marque de commerce / <sup>MD</sup> Marque déposée de Sears Brands, LLC



## Free Manuals Download Website

<http://myh66.com>

<http://usermanuals.us>

<http://www.somanuals.com>

<http://www.4manuals.cc>

<http://www.manual-lib.com>

<http://www.404manual.com>

<http://www.luxmanual.com>

<http://aubethermostatmanual.com>

Golf course search by state

<http://golfingnear.com>

Email search by domain

<http://emailbydomain.com>

Auto manuals search

<http://auto.somanuals.com>

TV manuals search

<http://tv.somanuals.com>