

Operator's Manual

CRAFTSMAN[®]

25cc/1.5 cu.in. 2-Cycle

17 Inch Cutting Path / .080 In. Line

GASOLINE WEEDWACKER[®]

Model No.

358.796280

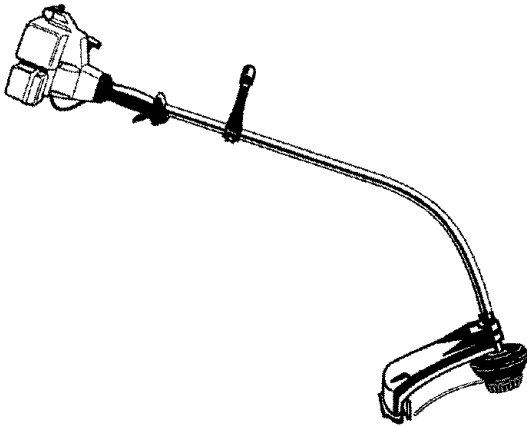

WARNING:

Read and follow all Safety Rules and Operating Instructions before first use of this product.



For answers to your questions about this product:
Call 7 am-7 pm, Mon.-Sat., or 10 am-7 pm, Sun.

1-800-235-5878 (Hours listed are Central Time)

Sears, Roebuck and Co., Hoffman Estates, IL 60179 USA

530088549 3/1/00

SAFETY

ASSEMBLY

OPERATION

MAINTENANCE

PARTS LIST

ESPAÑOL

TABLE OF CONTENTS

Warranty Statement	2	Storage	11
Safety Rules	2	Troubleshooting Chart	12
Assembly	4	Emissions Statement	12
Operation	5	Parts List	14
Maintenance	8	Spanish	17
Service & Adjustments	9	Parts and Ordering	Back

WARRANTY STATEMENT

FULL ONE YEAR WARRANTY ON CRAFTSMAN® GAS POWERED WEEDWACKER® LINE TRIMMER.

For one year from the date of purchase, when this Craftsman Gas Powered Weedwacker Line Trimmer is maintained, lubricated, and tuned up according to the operating and maintenance instructions in the Operator's Manual, Sears will repair, free of charge, any defect in materials or workmanship.

This warranty excludes nylon line, spark plug, and air filter, which are expendable parts and become worn during normal use.

If this Weedwacker line trimmer is used for commercial purposes, this warranty applies for only 90 days from the date of purchase. If this Weedwacker line trimmer is used for rental purposes, this warranty applies for only 30 days from the date of purchase. This warranty applies only while this product is in use in the United States.

WARRANTY SERVICE IS AVAILABLE BY RETURNING THE WEEDWACKER LINE TRIMMER TO THE NEAREST SEARS SERVICE CENTER IN THE UNITED STATES.

This warranty gives you specific legal rights, and you may also have other rights which vary from state to state.

Sears, Roebuck and Co., D/817 WA Hoffman Estates, IL 60179

SAFETY RULES

⚠ WARNING: When using gardening appliances, basic safety precautions must always be followed to reduce the risk of fire and serious injury. Read and follow all instructions.

This power unit can be dangerous! Operator is responsible for following instructions and warnings on unit and in manual. Read entire Operator's Manual before using unit! Be thoroughly familiar with the controls and the proper use of the unit. Restrict the use of this unit to persons who have read, understand, and will follow the instructions and warnings on the unit and in the manual. Never allow children to operate this unit.

SAFETY INFORMATION
ON THE UNIT



⚠ DANGER: Never use blades or felling devices. This unit is designed

for line trimmer use only. Use of any other accessories or attachments will increase the risk of injury.



⚠ WARNING: Trimmer line throws objects violently. You and others can be blinded/injured. Wear eye and leg protection. Keep body parts clear of rotating line. Keep children, bystanders, and animals 50 feet (15 meters) away. If approached stop unit immediately.

Eye Protection

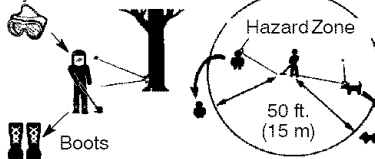

If situations occur which are not covered in this manual, use care and good judgment. If you need assistance, contact your Sears Service Center or call 1-800-235-5878.

OPERATOR SAFETY

- Always wear safety eye protection.
- Always wear long pants, long sleeves, boots, and gloves. Wearing safety leg guards is recommended. Do not go barefoot or wear sandals. Stay clear of spinning line.
- Secure hair above shoulder length. Secure or remove loose clothing or clothing with loosely hanging ties, straps, tassels, etc. They can be caught in moving parts. Being fully covered also helps protect you from debris and pieces of toxic plants thrown by spinning line.
- Do not operate when you are tired, ill, upset, or under the influence of alcohol, drugs, or medication.
- Wear hearing protection.
- Never start or run inside a closed room or building. Breathing exhaust fumes can kill.
- Keep handles free from oil and fuel.

UNIT / MAINTENANCE SAFETY

- Disconnect the spark plug before performing maintenance except carburetor adjustments.
- Look for and replace damaged or loose parts before each use. Look for and repair fuel leaks before use. Keep in good working condition.
- Replace trimmer head parts that are chipped, cracked, broken, or damaged in any other way before using the unit.
- Make sure unit is assembled correctly as shown in this manual.
- Make carburetor adjustments with lower end supported to prevent line from contacting any object.
- Keep others away when making carburetor adjustments.
- Use only recommended Craftsman accessories and replacement parts.

FUEL SAFETY

- Mix and pour fuel outdoors.
- Keep away from sparks or flames.
- Use a container approved for fuel.
- Do not smoke or allow smoking near fuel or the unit.

- Wipe up all fuel spills.
- Move at least 10 feet (3 meters) away from fueling site before starting engine.
- Stop engine and allow to cool before removing fuel cap.

CUTTING SAFETY

- Use only for trimming, scalping, mowing, edging, and sweeping. Do not use for pruning or hedge trimming.
- Inspect the area before each use. Remove objects (rocks, broken glass, nails, wire, etc.) which can be thrown by or become entangled in line. Hard objects can damage the trimmer head and be thrown causing serious injury.
- Keep firm footing and balance. Do not overreach.
- Keep all parts of your body away from muffler and spinning line. Keep engine below waist level. A hot muffler can cause serious burns.
- Cutting on left side of the shield will throw debris away from the operator.

TRANSPORTING AND STORAGE

- Allow engine to cool; secure unit before storing or transporting in vehicle.
- Empty the fuel tank before storing or transporting the unit. Use up fuel left in the carburetor by starting the engine and letting it run until it stops.
- Store unit and fuel in area where fuel vapors cannot reach sparks or open flames from water heaters, electric motors or switches, furnaces, etc.
- Store unit so line limiter cannot accidentally cause injury. The unit can be hung by the tube.
- Store unit out of reach of children.

If situations occur which are not covered in this manual, use care and good judgment. If you need assistance, call 1-800-235-5878.

SPECIAL NOTICE: This unit is not equipped with a temperature limiting muffler and spark arresting screen which meets the requirements of California Codes 4442 and 4443. All U.S. forest land and the states of California, Idaho, Maine, Minnesota, New Jersey, Oregon, and Washington require by law that many internal combustion en-

gines be equipped with a spark arrester screen. If you operate in a locale where such regulations exist, you are legally responsible for installing and maintaining the operating condition of these parts. Failure to do so is a violation of law. Contact a Sears Service Center for the correct parts.

SPECIAL NOTICE: Exposure to vibrations through prolonged use of gasoline powered hand tools could cause blood vessel or nerve damage in the fingers, hands, and joints of people prone to circulation disorders or abnormal swellings. Prolonged use

in cold weather has been linked to blood vessel damage in otherwise healthy people. If symptoms occur such as numbness, pain, loss of strength, change in skin color or texture, or loss of feeling in the fingers, hands, or joints, discontinue the use of this tool and seek medical attention. An anti-vibration system does not guarantee the avoidance of these problems. Users who operate power tools on a continual and regular basis must monitor closely their physical condition and the condition of this tool.

ASSEMBLY

CARTON CONTENTS

Check carton contents against the following list.

Model 358.796280

- Trimmer
- Shield
- Wing Nut (screwed onto shield)
- Container of Oil
- Replacement Spool

Examine parts for damage. Do not use damaged parts.

NOTE: If you need assistance or find parts missing or damaged, call 1-800-235-5878.

It is normal for the fuel filter to rattle in the empty fuel tank.

Finding fuel or oil residue on muffler is normal due to carburetor adjustments and testing done by the manufacturer.

ASSEMBLY

WARNING: If received assembled, repeat all steps to ensure your unit is properly assembled and all fasteners are secure.

ADJUSTING THE HANDLE

WARNING: When adjusting the handle, be sure it remains between the trigger and the safety label.

- Loosen wing nut or knob on handle.
- Rotate the handle on the tube to an upright position; retighten wing nut.

ATTACHING SHIELD

WARNING: The shield must be properly installed. The shield provides partial protection from the risk of thrown objects to the operator and others and is equipped with a line limiter which cuts excess line to the proper length. The line limiter (on underside of shield) is sharp and can cut you. For proper orientation, see illustration in OPERATION section.

- Remove wing nut from shield.
- Insert bracket into slot as shown.
- Pivot shield until bolt passes through hole in bracket.
- Securely tighten wing nut onto bolt.

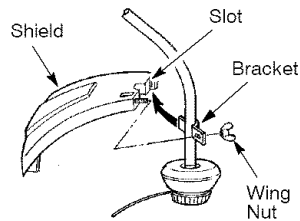

OPERATION

KNOW YOUR TRIMMER

READ THIS OPERATOR'S MANUAL AND SAFETY RULES BEFORE OPERATING YOUR UNIT. Compare the illustrations with your unit to familiarize yourself with the location of the various controls and adjustments. Save this manual for future reference.

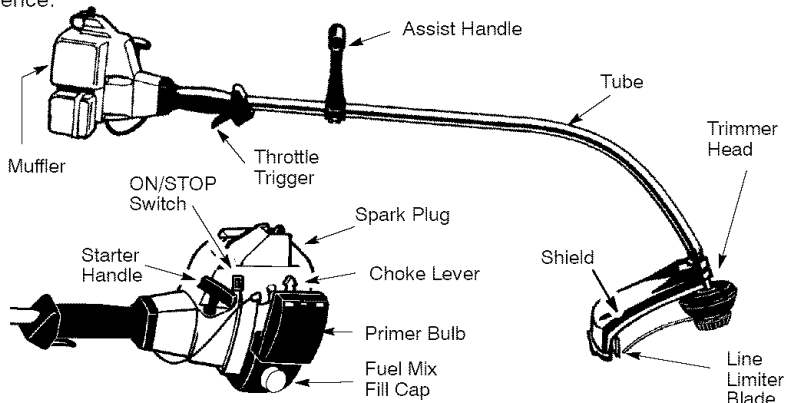

ON/STOP SWITCH

The STOP switch is used to stop engine. Press and hold switch to stop engine.

PRIMER BULB

The PRIMER BULB removes air from the carburetor and fuel lines and fills them with fuel. This allows you to start the engine with fewer pulls on the starter rope. Activate the primer bulb by pressing it and allowing it to return to its original form.

CHOKE

The CHOKE helps to supply fuel to the engine to aid in cold starting. Activate the choke by moving the choke lever to the FULL CHOKE position. After the engine attempts to start, move the choke lever to the HALF CHOKE position. Once engine has started, move the choke lever to the OFF CHOKE position.

BEFORE STARTING ENGINE

WARNING: Be sure to read the fuel information in the safety rules before you begin. If you do not understand the safety rules, do not attempt to fuel your unit. Call 1-800-235-5878.

FUELING ENGINE

This engine is certified to operate on unleaded gasoline. Before operation, gasoline must be mixed with a good quality 2-cycle air-cooled engine oil. We recommend Craftsman brand oil. Mix gasoline and oil at a ratio of 40:1 (A 40:1 ratio is obtained by mixing 3.2 ounces of oil with 1 gallon of unleaded gasoline). DO NOT USE automotive oil or boat oil. These oils will cause

engine damage. When mixing fuel, follow instructions printed on container.

Once oil is added to gasoline, shake container momentarily to assure that the fuel is thoroughly mixed. Always read and follow the safety rules relating to fuel before fueling your unit.

IMPORTANT

Experience indicates that alcohol blended fuels (called gasohol or using ethanol or methanol) can attract moisture which leads to separation and formation of acids during storage. Acidic gas can damage the fuel system of an engine while in storage.

To avoid engine problems, empty the fuel system before storage for 30 days

or longer. Drain the gas tank, start the engine and let it run until the fuel lines and carburetor are empty. Use fresh fuel next season.

Never use engine or carburetor cleaner products in the fuel tank or permanent damage may occur.

See the STORAGE section for additional information.

STOPPING YOUR ENGINE

- Press and hold the ON/STOP switch in the STOP position.
- If engine does not stop, move choke lever to FULL CHOKE position.

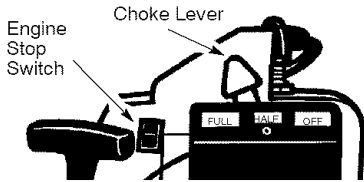

STARTING YOUR ENGINE COLD ENGINE OR WARM ENGINE AFTER RUNNING OUT OF FUEL

⚠ WARNING: The trimmer head will turn while starting the engine. Avoid any contact with the muffler. A hot muffler can cause serious burns.

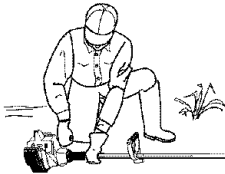

- Set unit on a flat surface.
- Slowly press the primer bulb 6 times.
- Move choke lever to FULL CHOKE position.
- Squeeze the throttle trigger fully and hold through *all remaining steps*.

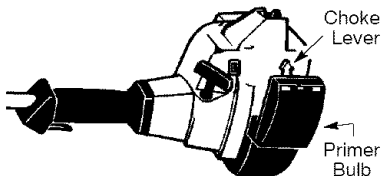

- Pull starter rope handle sharply 6 times.

NOTE: If the engine sounds as if it is trying to start before the 6th pull, go to the next step.

- Move choke lever to HALF CHOKE position.
- Pull starter rope sharply until engine runs, but no more than 6 pulls.

NOTE: If the engine has not started after 6 pulls (at HALF CHOKE), check to make sure the choke lever is in the proper position. Then, move the choke lever to the FULL CHOKE position and press the primer bulb 6 times; squeeze and hold the throttle trigger and pull the starter rope 2 more times. Move the choke lever to HALF CHOKE and pull the starter rope until the engine runs, but no more than 6 more pulls. If the engine still has not started, it is probably flooded. Proceed to STARTING A FLOODED ENGINE.

- Allow the engine to run 10 seconds, then move the choke lever to OFF CHOKE. Allow the unit to run for 30 more seconds at OFF CHOKE before releasing the throttle trigger.

NOTE: If engine dies with the choke lever at the OFF CHOKE position, move the choke lever to HALF CHOKE and pull the rope until engine runs.

STARTING A WARM ENGINE

- Move the choke lever to the HALF CHOKE position.
- Squeeze and hold the throttle trigger. Keep throttle trigger fully squeezed until the engine runs smoothly.
- Pull starter rope sharply until engine runs, but no more than 5 pulls.
- Allow engine to run 15 seconds, then move the choke lever to OFF CHOKE.

NOTE: If engine has not started, pull starter rope 5 more pulls. If engine still does not run, it is probably flooded.

DIFFICULT STARTING OR STARTING A FLOODED ENGINE

Flooded engines can be started by placing the choke lever in the OFF CHOKE position; then, pull the rope to clear the engine of excess fuel. This could require pulling the starter handle many times depending on how badly the unit is flooded.

If the unit still doesn't start, refer to TROUBLESHOOTING CHART or call 1-800-235-5878.

OPERATING INSTRUCTIONS

OPERATING POSITION

ALWAYS WEAR:

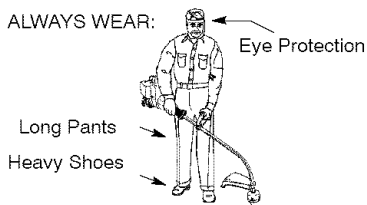

Cut from your right to your left.

Do not run the engine at a higher speed than necessary. The cutting line will cut efficiently when the engine is run at less than full throttle. At lower speeds, there is less engine noise and vibration. The cutting line will last longer and will be less likely to "weld" onto the spool.

Always release the throttle trigger and allow the engine to return to idle speed when not cutting.

To stop engine:

- Release the throttle trigger.
- Push and hold the engine stop switch in the STOP or OFF position until the unit has fully stopped.

TRIMMER LINE ADVANCE

The cutting head advances line automatically. Do not tap head on the ground to advance line. This may break parts and cause cutting head to malfunction.

Upon unit start up, the line will advance automatically to the correct cutting path length.

Always keep the shield in place when the tool is being operated.

⚠ WARNING: Use only .080" (2 mm) diameter round line. Other sizes and shapes of line will not advance properly and will result in improper cutting head function or can cause serious injury. Do not use other materials such as wire, string, rope, etc. Wire can break off during cutting and become a dangerous missile that can cause serious injury.

CUTTING METHODS

⚠ WARNING: Use minimum speed and do not crowd the line when cutting around hard objects (rock, gravel, fence posts, etc.), which can damage the trimmer head, become entangled in the line, or be thrown causing a serious hazard.

- The tip of the line does the cutting. You will achieve the best performance and minimum line wear by not crowding the line into the cutting area. The right and wrong ways are shown below.

Tip of the Line Does The Cutting

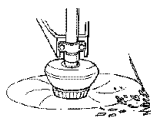

Right

Line Crowded Into Work Area



Wrong

- The line will easily remove grass and weeds from around walls, fences, trees and flower beds, but it also can cut the tender bark of trees or shrubs and scar fences.
- For trimming or scalping, use less than full throttle to increase line life and decrease head wear, especially:
 - During light duty cutting.
 - Near objects around which the line can wrap such as small posts, trees or fence wire.
- For mowing or sweeping, use full throttle for a good clean job.

⚠ WARNING: Always wear eye protection. Never lean over the trimmer head. Rocks or debris can ricochet or be thrown into eyes and face and cause blindness or other serious injury.

TRIMMING - Hold the bottom of the trimmer head about 3 in. (8 cm) above the ground and at an angle. Allow only the tip of the line to make contact. Do not force trimmer line into work area.

Trimming

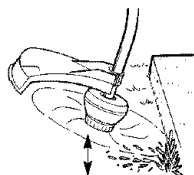

3 in. (8 cm)
Above Ground

SCALPING - The scalping technique removes unwanted vegetation. Hold the bottom of the trimmer head about 3 in. (8 cm) above the ground and at an angle. Allow the tip of the line to strike the ground around trees, posts, monuments, etc. This technique increases line wear.

Scalping

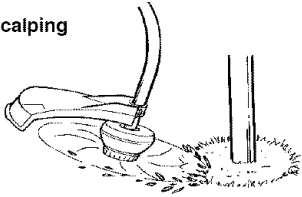

MOWING - Your trimmer is ideal for mowing in places conventional lawn mowers cannot reach. In the mowing position, keep the line parallel to the ground. Avoid pressing the head into the ground as this can scalp the ground and damage the tool.

Mowing

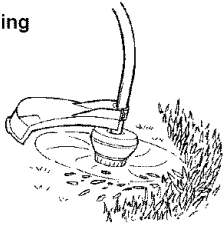

SWEEPING - The fanning action of the rotating line can be used for a quick and easy clean up. Keep the line parallel to and above the surfaces being swept and move the tool from side to side.

Sweeping

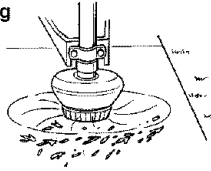

EDGING - Your unit can be used for edging sidewalks, patios, driveways, etc. While edging, allow the tip of the line to make contact. Do not force line. Take extra caution while edging as objects can be struck.

Edging

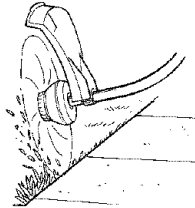

MAINTENANCE

MAINTENANCE SCHEDULE

CARE & MAINTENANCE TASK	WHEN TO PERFORM
Check for Loose fasteners and parts	Before each use
Check for damaged or worn parts	Before each use
Clean unit and labels	After each use
Clean air filter	Every 5 hours of operation
Replace spark plug	Yearly

GENERAL RECOMMENDATIONS

The warranty on this unit does not cover items that have been subjected to operator abuse or negligence. To receive full value from the warranty, the operator must maintain unit as instructed in this manual. Various adjustments will need to be made periodically to properly maintain your unit.

CHECK FOR LOOSE FASTENERS AND PARTS

- Spark Plug Boot
- Air Filter
- Housing Screws
- Assist Handle Screws
- Debris Shield

CHECK FOR DAMAGED OR WORN PARTS

Refer replacement of damaged/worn parts to your Sears Service Center.

- ON/STOP Switch - Ensure ON/STOP switch functions properly by pressing and holding the switch in the STOP position. Make sure engine stops; then restart engine and continue.
- Fuel Tank - Discontinue use of unit if fuel tank shows signs of damage or leaks.
- Debris Shield - Discontinue use of unit if debris shield is damaged.

CLEAN UNIT & LABELS

- Clean the unit using a damp cloth with a mild detergent.
- Wipe off unit with a clean dry cloth.

CLEAN AIR FILTER

A dirty air filter decreases engine performance and increases fuel consumption and harmful emissions. Always clean after every 5 hours of operation.

- Clean the cover and the area around it to keep dirt from falling into the carburetor chamber when the cover is removed.

- Remove parts as illustrated.
- NOTE:** Do not clean filter in gasoline or other flammable solvent to avoid creating a fire hazard or producing harmful evaporative emissions.
- Wash the filter in soap and water.
 - Allow filter to dry.
 - Add a few drops of oil to the filter; squeeze the filter to distribute oil.
 - Replace parts.

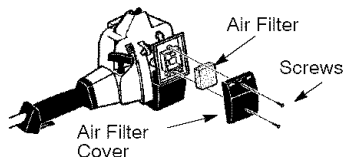

REPLACE SPARK PLUG

Replace the spark plug each year to ensure the engine starts easier and runs better. Set spark plug gap at .025 in. Ignition timing is fixed and nonadjustable.

- Twist, then pull off spark plug boot.
- Remove spark plug from cylinder and discard.
- Replace with Champion CJ-8Y spark plug and tighten with a 3/4 in. socket wrench (10-12 ft.-lbs).
- Reinstall the spark plug boot.

SERVICE AND ADJUSTMENTS

LINE REPLACEMENT

Pre-wound spools offer the most convenient method for replacing line and ensuring optimum performance.

- Replacement spools are color-coded to ensure use of the correct spool with your unit. Be sure to use the same color spool as the existing spool.

NOTE: Always clear dirt and debris from cutting head components when performing any type of maintenance.

- Hold spool and unscrew cap by turning in the direction shown on top of the cap.
- Remove line guide ring and spool.

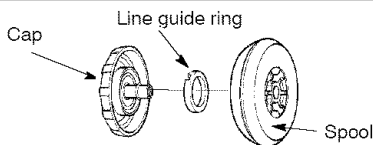

Use a pre-wound spool or refill spool with line. If using a pre-wound spool, remove tape strip from line and spool.

REFILLING THE SPOOL WITH LINE

⚠ WARNING: Use only .080" (2 mm) diameter round line. Other sizes and shapes of line will not advance properly and will result in im-

proper cutting head function or can cause serious injury. Do not use other materials such as wire, string, rope, etc. Wire can break off during cutting and become a dangerous missile that can cause serious injury.

- Cut a length of 30 feet of .080" (2 mm) diameter round Craftsman brand line.

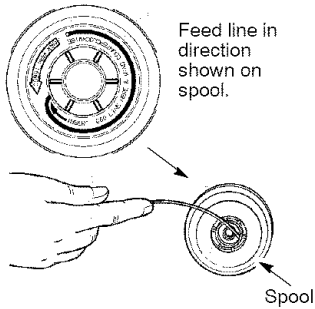

- Insert one end of line into center cavity of empty spool. Ensure line will feed into spool in the direction shown on the spool (counterclockwise).
- Continue feeding line into spool, leaving 4 - 6 inches (10 - 15 cm) unwound from center of spool.

INSTALLING SPOOL WITH LINE

- Install replacement spool.
- Thread line through line guide ring.

Line through guide ring

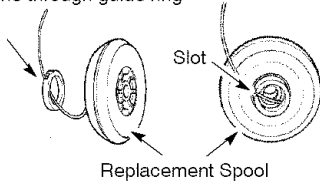

- Rest guide ring on spool and place line through slot. Allow line to extend 4 - 6 inches (10 - 15 cm) from center of spool.
- Ensure line remains in slot while screwing cap on to the shaft. **Only tighten cap hand tight!**

CARBURETOR ADJUSTMENT

⚠ WARNING: The trimmer head will be spinning during most of this procedure. Wear your protective equipment and observe all safety precautions. After making mixture adjustments, recheck idle speed.

Carburetor adjustment is critical and if done improperly can permanently damage the engine as well as the carburetor. If you require further assistance or are unsure about performing this procedure, call our customer assistance help line at 1-800-235-5878. Old fuel, a dirty air filter, a dirty fuel filter, or flooding may give the impression of an improperly adjusted carburetor. Check these conditions before adjusting the carburetor.

The carburetor has been carefully set at the factory. Adjustments may be necessary if you notice any of the following conditions:

- Engine will not idle. See IDLE SPEED under adjusting procedure.
- Engine dies or hesitates instead of accelerating. See ACCELERATION CHECK under adjusting procedure.
- Loss of cutting power. See MIXTURE ADJUSTMENT under adjusting procedure.

There are two adjustment screws on the carburetor.

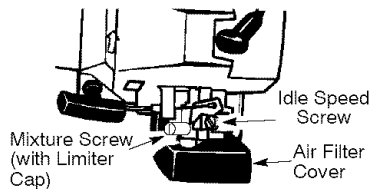

CARBURETOR PRESETS

When making carburetor preset adjustments, do not force plastic limiter caps beyond stops or damage will occur.

If carburetor presets are not needed, proceed to ADJUSTING PROCEDURE, IDLE SPEED.

To adjust presets:

- Turn mixture screw counterclockwise until it stops.
- Turn the idle speed screw clockwise until it stops. Now turn counterclockwise 4-1/2 turns.
- Start motor, cut grass for 3 minutes, and proceed to the adjustment section. If engine does not start, refer to TROUBLESHOOTING CHART or call 1-800-235-5878.
- If engine performance is acceptable at the preset positions, no further adjustment is necessary.

ADJUSTING PROCEDURE

Idle Speed

Allow engine to idle. Adjust speed until engine runs without stalling.

- Turn clockwise to increase engine speed if engine stalls or dies.
- Turn counterclockwise to decrease speed.

No further adjustments are necessary if performance is satisfactory.

Mixture Adjustment "H"

DO NOT operate engine at full throttle for prolonged periods while making adjustments. Damage to the engine can occur. Ensure line is fully extended.

Based on performance while cutting, turn the mixture adjustment in 1/16-turn increments as follows:

- Clockwise until the engine has good power while cutting with no hesitation. Do not adjust by sound or speed, but judge by how well the engine performs while cutting.
- Counterclockwise if the engine has speed but dies or lacks power while cutting.

After completing adjustments, check for acceleration. Reset if necessary.

Acceleration Check

If engine dies or hesitates instead of accelerating, turn mixture adjustment counterclockwise until you have smooth acceleration. Recheck and adjust as necessary for acceptable performance.

STORAGE

Prepare unit for storage at end of season or if it will not be used for 30 days or more.

WARNING:

- Allow engine to cool, and secure the unit before storing or transporting.
- Store unit and fuel in a well ventilated area where fuel vapors cannot reach sparks or open flames from water heaters, electric motors or switches, furnaces, etc.
- Store unit with all guards in place. Position unit so that any sharp object cannot accidentally cause injury.
- Store unit and fuel well out of the reach of children.

EXTERNAL SURFACES

If your unit is to be stored for a period of time, clean it thoroughly before storage. Store in a clean dry area.

- Lightly oil external metal surfaces.

FUEL SYSTEM

Under FUELING ENGINE in the OPERATION section of this manual, see message labeled **IMPORTANT** regarding the use of gasohol in your engine.

Fuel stabilizer is an acceptable alternative in minimizing the formation of fuel gum deposits during storage. Add

stabilizer to the gasoline in the fuel tank or fuel storage container. Follow the mix instructions found on stabilizer container. Run engine at least 5 minutes after adding stabilizer.

Craftsman 40:1, 2-cycle engine oil (air cooled) is already blended with fuel stabilizer. If you do not use this Sears oil, you can add a fuel stabilizer to your fuel tank.

INTERNAL ENGINE

- Remove spark plug and pour 1 teaspoon of 40:1, 2-cycle engine oil (air cooled) through the spark plug opening. Slowly pull the starter rope 8 to 10 times to distribute oil.
- Replace spark plug with new one of recommended type and heat range.
- Clean air filter.
- Check entire unit for loose screws, nuts, and bolts. Replace any damaged, broken, or worn parts.
- At the beginning of the next season, use only fresh fuel having the proper gasoline to oil ratio.

OTHER

- Do not store gasoline from one season to another.
- Replace your gasoline can if it starts to rust.

TROUBLESHOOTING CHART

TROUBLE	CAUSE	REMEDY
Engine will not start.	<ul style="list-style-type: none"> • Engine flooded. • Fuel tank empty. • Spark plug not firing. • Fuel not reaching carburetor. • Compression low. 	<ul style="list-style-type: none"> • See "Starting Instructions." • Fill tank with correct fuel mixture. • Install new spark plug. • Check for dirty fuel filter; replace. Check for kinked or split fuel line; repair or replace. • Contact a Sears Service Center.
Engine will not idle properly.	<ul style="list-style-type: none"> • Idle speed set too low. • Idle speed set too high. • Carburetor requires adjustment. • Crankshaft seals worn. • Compression low. 	<ul style="list-style-type: none"> • Adjust idle speed screw clockwise to increase speed. • Adjust idle speed screw counter-clockwise to reduce speed. • See "Carburetor Adjustments." • Contact a Sears Service Center. • Contact a Sears Service Center.
Engine will not accelerate, lacks power, or dies under a load.	<ul style="list-style-type: none"> • Air filter dirty. • Spark plug fouled. • Carburetor requires adjustment. • Carbon build up. • Compression low. 	<ul style="list-style-type: none"> • Clean or replace air filter. • Clean or replace spark plug and re-gap. • See "Carburetor Adjustments." • Contact a Sears Service Center. • Contact a Sears Service Center.
Engine smokes excessively.	<ul style="list-style-type: none"> • Choke partially on. • Fuel mixture incorrect. • Air filter dirty. • Carburetor requires adjustment. 	<ul style="list-style-type: none"> • Move choke to off position. • Empty fuel tank and refill with correct fuel mixture. • Clean or replace air filter. • See "Carburetor Adjustments."
Engine runs hot.	<ul style="list-style-type: none"> • Fuel mixture incorrect. • Spark plug incorrect. • Carburetor requires adjustment • Carbon build up. 	<ul style="list-style-type: none"> • See "Fueling Your Unit." • Replace with correct spark plug. • See "Carburetor Adjustments." • Contact a Sears Service Center.

U.S. EPA EMISSION CONTROL WARRANTY STATEMENT

YOUR WARRANTY RIGHTS AND OBLIGATIONS: The U. S. Environmental Protection Agency and SEARS, ROEBUCK AND CO., USA are pleased to explain the emissions control system warranty on your lawn and garden equipment engine. All new utility and lawn and garden equipment engines must be designed, built, and equipped to meet the stringent anti-smog standards. SEARS must warrant the emission control system on your lawn and garden equipment engine for the periods of time listed below provided there has been no

abuse, neglect, or improper maintenance of your lawn and garden equipment engine. Your emission control system includes parts such as the carburetor and the ignition system.

Where a warrantable condition exists, SEARS will repair your lawn and garden equipment engine at no cost to you. Expenses covered under warranty include diagnosis, parts and labor.

MANUFACTURER'S WARRANTY COVERAGE: If any emissions related part on your engine (as listed under Emissions Control Warranty Parts List) is defective or a defect in the ma-

materials or workmanship of the engine causes the failure of such an emission related part, the part will be repaired or replaced by SEARS. **OWNER'S WARRANTY RESPONSIBILITIES:** As the lawn and garden equipment engine owner, you are responsible for the performance of the required maintenance listed in your Owner's Manual. SEARS recommends that you retain all receipts covering maintenance on your lawn and garden equipment engine, but SEARS cannot deny warranty solely for the lack of receipts or for your failure to ensure the performance of all scheduled maintenance.

As the lawn and garden equipment engine owner, you should be aware that SEARS may deny you warranty coverage if your lawn and garden equipment engine or a part of it has failed due to abuse, neglect, improper maintenance, unapproved modifications, or the use of parts not made or approved by the original equipment manufacturer. You are responsible for presenting your lawn and garden equipment engine to a SEARS authorized repair center as soon as a problem exists. Warranty repairs should be completed in a reasonable amount of time, not to exceed 30 days. If you have any questions regarding your warranty rights and responsibilities, you should contact your nearest authorized service center or call SEARS at 1-800-473-7247.

WARRANTY COMMENCEMENT DATE: The warranty period begins on the date the lawn and garden equipment engine is purchased. **LENGTH OF COVER-**

AGE: This warranty shall be for a period of two years from the initial date of purchase. **WHAT IS COVERED: REPAIR OR REPLACEMENT OF**

PARTS. Repair or replacement of any warranted part will be performed at no charge to the owner at an approved SEARS servicing center. If you have any questions regarding your warranty rights and responsibilities, you should contact your nearest authorized service center or call SEARS at 1-800-473-7247. **WARRANTY PERIOD:** Any warranted part which is not

scheduled for replacement as required maintenance, or which is scheduled only for regular inspection to the effect of "repair or replace as necessary" shall be warranted for 2 years. Any warranted part which is scheduled for replacement as required maintenance shall be warranted for the period of time up to the first scheduled replacement point for that part. **DIAGNOSIS:** The owner shall not be charged for diagnostic labor which leads to the determination that a warranted part is defective if the diagnostic work is performed at an approved SEARS servicing center. **CONSEQUENTIAL DAMAGES:** SEARS may be liable for damages to other engine components caused by the failure of a warranted part still under warranty. **WHAT IS NOT COVERED:** All failures caused by abuse, neglect, or improper maintenance are not covered. **ADD-ON OR MODIFIED PARTS:** The use of add-on or modified parts can be grounds for disallowing a warranty claim. SEARS is not liable to cover failures of warranted parts caused by the use of add-on or modified parts. **HOW TO FILE A CLAIM:** If you have any questions regarding your warranty rights and responsibilities, you should contact your nearest authorized service center or call SEARS at 1-800-473-7247. **WHERE TO GET WARRANTY SERVICE:** Warranty services or repairs shall be provided at all SEARS service centers. call: 1-800-473-7247. **MAINTENANCE, REPLACEMENT AND REPAIR OF EMISSION RELATED PARTS:** Any SEARS approved replacement part used in the performance of any warranty maintenance or repair on emission related parts will be provided without charge to the owner if the part is under warranty. **EMISSION CONTROL WARRANTY PARTS LIST:** Carburetor, Ignition System: Spark Plug (covered up to maintenance schedule), Ignition Module. **MAINTENANCE STATEMENT:** The owner is responsible for the performance of all required maintenance as defined in the owner's manual.

Free Manuals Download Website

<http://myh66.com>

<http://usermanuals.us>

<http://www.somanuals.com>

<http://www.4manuals.cc>

<http://www.manual-lib.com>

<http://www.404manual.com>

<http://www.luxmanual.com>

<http://aubethermostatmanual.com>

Golf course search by state

<http://golfingnear.com>

Email search by domain

<http://emailbydomain.com>

Auto manuals search

<http://auto.somanuals.com>

TV manuals search

<http://tv.somanuals.com>