

SEARS

OWNER'S MANUAL

Model No.

390.291198

390.291358

390.291558

390.291658

390.291698

390.291758

CAUTION:

Read and Follow
All Safety Rules and
Operating Instructions
Before First Use of
This Product.

Save This Manual For
Future Reference.

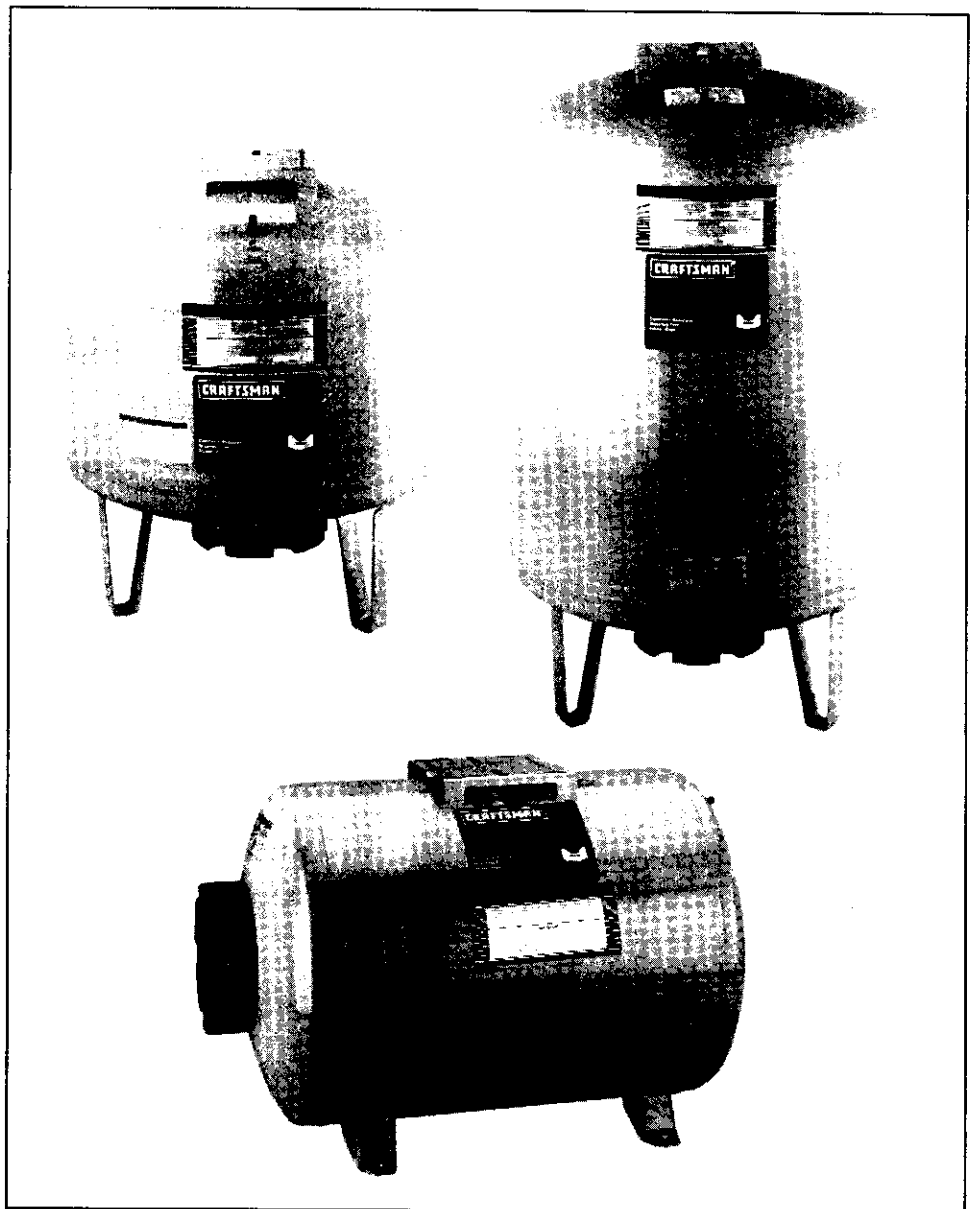

CRAFTSMAN® CAPTIVE AIR® TANK

- Safety Instructions
- Installation
- Operation
- Service Hints
- Repair Parts

Sears, Roebuck and Co., Hoffman Estates, IL 60179 U.S.A.

READ AND FOLLOW SAFETY INSTRUCTIONS!



⚠ DANGER

⚠ WARNING

⚠ CAUTION

This is the safety alert symbol. When you see this symbol on your tank or in this manual, look for one of the following signal words and be alert to the potential for personal injury:

DANGER warns about hazards that **will** cause serious personal injury, death or major property damage if ignored.

WARNING warns about hazards that **will** or **can** cause serious personal injury, death or major property damage if ignored.

CAUTION warns about hazards that **will** or **can** cause minor personal injury or property damage if ignored.

The label **NOTICE** indicates special instructions which are important but not related to hazards.

Carefully read and follow all safety instructions in this manual and on tank.

Keep safety labels in good condition.

Replace missing or damaged safety labels.

RULES FOR SAFE INSTALLATION AND OPERATION

1. Read these Rules and the Instructions carefully. Failure to follow them could cause serious bodily injury and/or property damage.

⚠ WARNING
Hazardous pressure

These water storage tanks are designed for operation on cold well water systems limited to a maximum working pressure of 100 pounds per square inch (PSI). If your water system can exceed 100 P.S.I., install a Sears No. 2729 relief valve on the system. Failure to follow these instructions can cause tank blow-up and result in serious injury.

NOTICE: Although No. 2729 Relief Valve is set to open at 75 PSI, for your safety Captive Air® Tanks are designed and rated to operate at up to 100 PSI.

2. Be sure installation meets all local plumbing, pump, electrical and well codes.
3. Always test water from well for purity before using. Call your local health department for testing procedure.
4. Before installing or servicing your pump, BE SURE pump power source is disconnected.

FULL FIVE YEAR WARRANTY on CRAFTSMAN® CAPTIVE AIR® TANK

For five years from the date of purchase, Sears will replace the tank free of charge, if defective in materials or workmanship. This warranty does not cover repairs or replacement parts necessary because of abuse or negligence, including failure to install, adjust and operate this tank according to the instructions in the owner's manual.

LIMITATION OF LIABILITY

SEARS WILL NOT BE LIABLE FOR LOSS OR DAMAGE TO PROPERTY OR ANY INCIDENTAL OR CONSEQUENTIAL LOSS OR EXPENSE FROM PROPERTY DAMAGE DUE DIRECTLY OR INDIRECTLY FROM THE USE OF THIS PRODUCT.

Some states do not allow the exclusion or limitation of incidental or consequential damages, so the above limitation or exclusion may not apply to you.

WARRANTY SERVICE IS AVAILABLE BY SIMPLY CONTACTING THE NEAREST SEARS SERVICE CENTER/DEPARTMENT IN THE UNITED STATES. FOR SERVICE OUTSIDE THE U.S.A., CONTACT YOUR LOCAL SEARS SERVICE CENTER OR STORE.

This warranty gives you specific legal rights, and you may also have other rights which vary from state to state.

Sears, Roebuck and Co., Dept. 817 WA, Hoffman Estates, IL 60179

CONTENTS

WARRANTY	2
SAFETY	2
INSTALLATION	3-6
OPERATION	7
SERVICE HINTS	7-9
REPAIR PARTS.....	10-11

INTRODUCTION

Please read our instructions before you install and use your tank. This will help you obtain full benefits from this tank. It will also help you avoid needless service expense that result from causes we cannot control and cannot cover in our Warranty.

BASIC TOOLS AND MATERIALS NEEDED

PLASTIC PIPE INSTALLATIONS

TOOLS	MATERIALS
Pipe Wrenches	Plastic Pipe and Fittings (as required to complete job).
Screwdriver	Teflon Tape (DO NOT use pipe joint compound on plastic fittings) or Plasto-Joint Stik*
Knife or Saw to Cut Plastic Pipe	
Tire Pressure Gauge	

GALVANIZED STEEL PIPE INSTALLATIONS

TOOLS	MATERIALS
Pipe Wrenches	Galvanized Pipe and Fittings (as required to complete job).
Screwdrivers	Pipe Joint Compound or Teflon tape
Pipe Cutting and Threading Tools	
Tire Pressure Gauge	

INSTALLATION



If your system can develop more than 100 PSI pressure, install a Sears No. 2729 relief valve in system to prevent possibility of

tank blow-up.

NOTICE: DO NOT use any type of lubricant other than water on Hose to Plastic fittings.

If rigid piping is installed to elbow on inlet flange, BE SURE to support the piping.

For proper installation of your pump to tank, follow one of the typical installations on Page 4 and 5. Use Teflon tape on all threaded connections to tank.

Standard pipe fittings, such as nipples, tees and elbows must be purchased locally. If you are using a horizontal jet pump mounted on top of tank, Figures 5 and 6, Kit No. 2788 is required. See Page 10 for contents of kit.

If your present system has an air volume control (AVC), remove it and plug AVC port on pump.

Complete pump, tank, and piping system MUST be protected against below freezing temperature. Failure to do so could cause severe damage and voids the warranty.

* Lake Chemical Co., Chicago, Illinois.

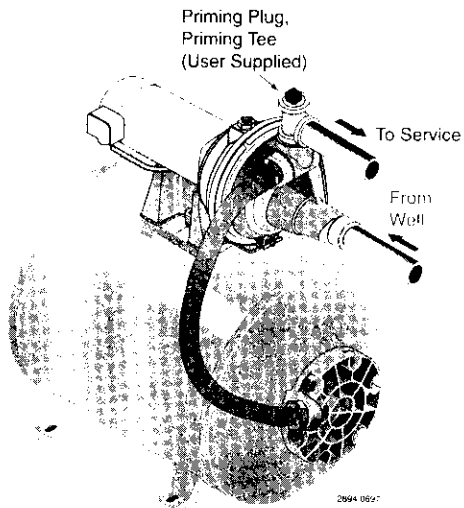

FIGURE 1 – Typical Installation: Shallow Well Jet On Horizontal Tank. To Mount Pump To Tank, Purchase Tank Fittings Kit 2788.

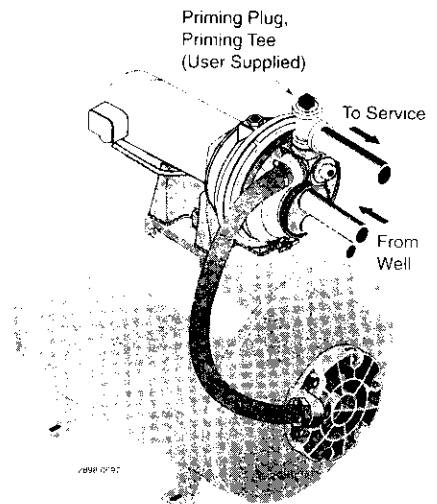

FIGURE 2 – Typical Installation: Deep Well Jet On Horizontal Tank. To Mount Pump To Tank, Purchase Tank Fittings Kit 2788.

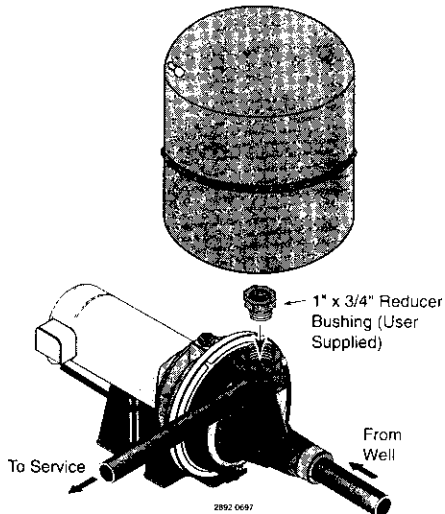

FIGURE 3 – 2 Gallon Tank Mounted Above Shallow Well Jet Pump

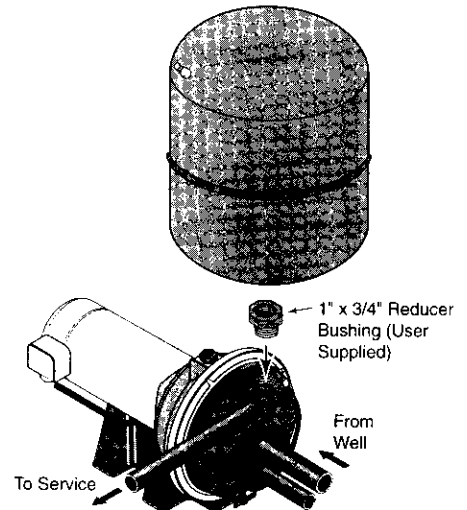

FIGURE 4 – 2 Gallon Tank Mounted Above Deep Well Jet Pump

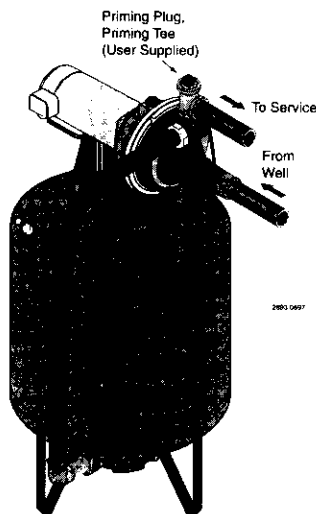

FIGURE 5 – Vertical Tank With Shallow Well Jet Pump

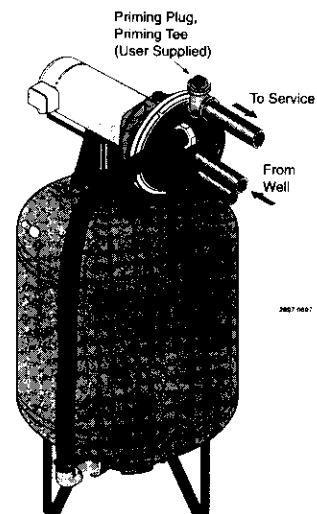
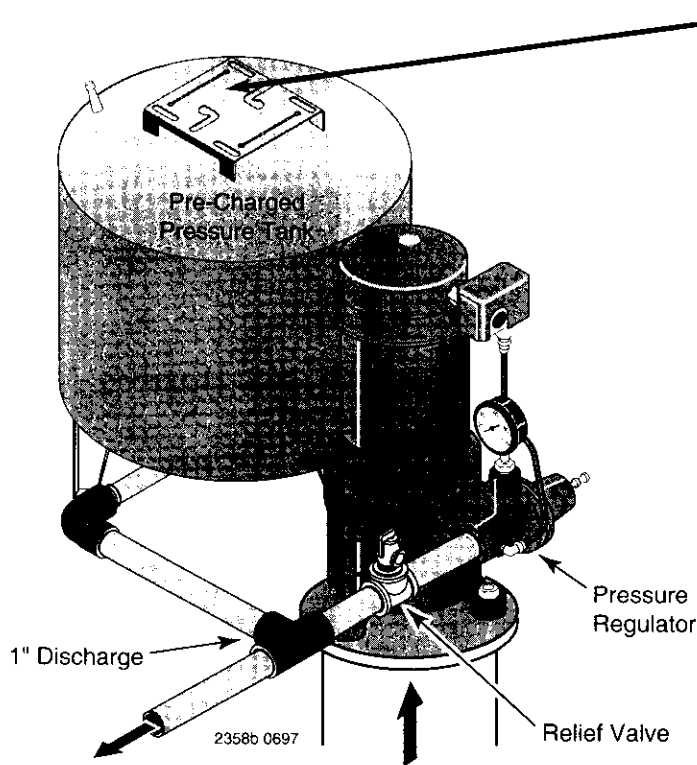

FIGURE 6 – Vertical Tank With Deep Well Jet Pump

INSTALLATION



NOTICE: 50 and 85 gallon tanks are not equipped with mounting bracket. Install pump beside tank as shown.

NOTICE: When using plastic fitting or installing a plastic pump, use only Teflon tape or Plasto-Joint Stik on male threads.

- 1* - 1" x 1" Tee
- 2* - 1" Nipple
- 3* - 1-1/4" X 1" Reducer Bushing Required for 50 and 85 gallon tanks.

*Not furnished - must be purchased locally

Pump To Tank Fittings Package - Not Furnished With Tank, Purchase Kit Stock No. 2788 From Your Sears Store.

FIGURE 6 - 19, 36, 50 and 85 Gallon Tanks With Multi-Stage Pumps

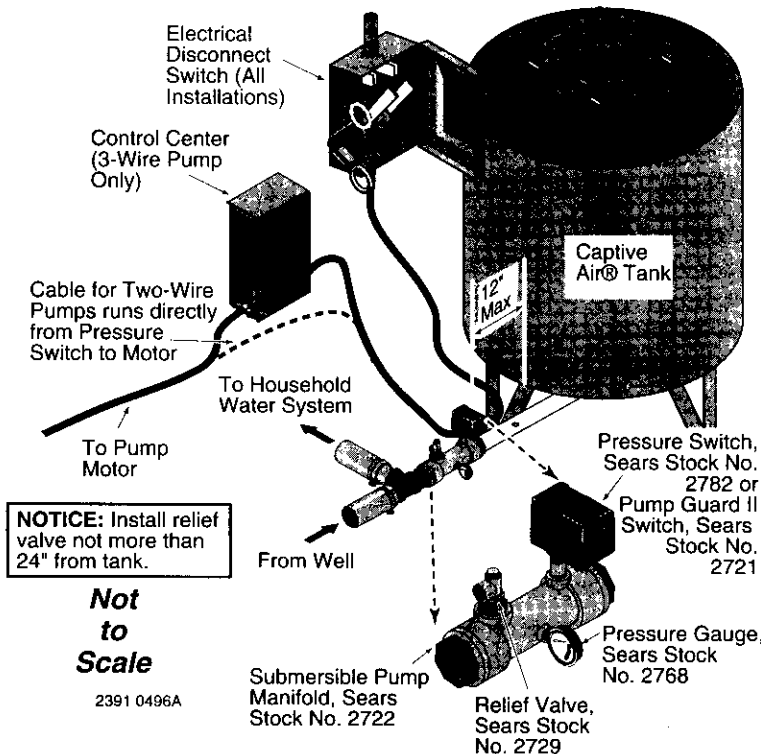

- TANK SIZES**
- 19 GALLON**
- 36 GALLON**
- 50 GALLON****
- 85 GALLON****

WARNING High capacity pumps should be used with the 50 or 85 gallon tank only.

** 1-1/4" to 1" reducer required for 1" piping.

Note: Relief Valve (No. 2729) must be purchased separately.

FIGURE 7 - Tanks With High Capacity Or Residential Size Submersible Pumps

INSTALLATION

⚠ WARNING
Hazardous
pressure

If your system can develop more than 100 PSI pressure, install a Sears No. 2729 relieve valve in system to prevent possibility of tank blow-up.

NOTICE: All Captive Air® Tanks except Models 390.291198 and 390.291358 are designed to operate in the vertical position.

The tank is shipped from the factory with a pre-charge of air. This system DOES NOT require the use of any outside air charging devices such as air volume controls on jet pumps, or bleeder orifices on submersible pumps.

Captive Air® Tanks can be connected together to increase the supply of usable water (drawdown). Two tanks of the same size will double the supply and three tanks will triple the supply. See Figures 8 and 9 for typical installations.

When using a submersible pump, the manifold and switch assembly must be installed in the pipe line as close to the center of the tanks as possible. See Figures 8 and 9.

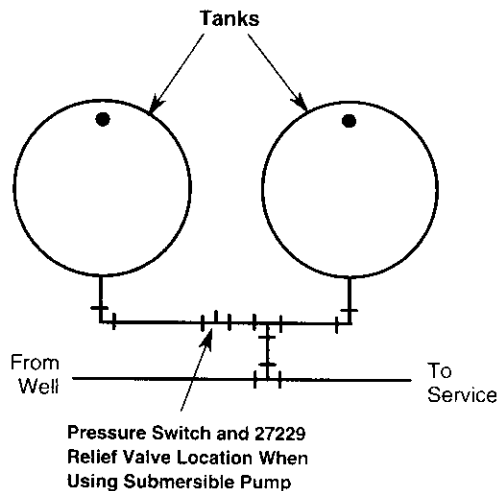

FIGURE 8

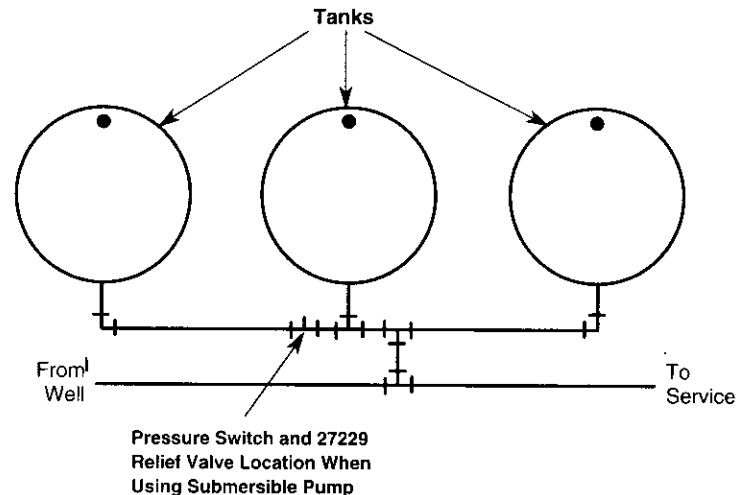

FIGURE 9

OPERATION

BEFORE YOU START YOUR PUMP

Your tank is factory charged with forty (40) pounds of air pressure. To determine pressure switch setting, see pump owner's manual. If your pump pressure switch cut-in setting is less than forty (40) pounds, the tank air pressure MUST be reduced to this cut-in pressure switch setting (see table). To do this, bleed air from the valve located on top of the tank. Check pressure frequently with an accurate tire pressure gauge until correct pressure has been reached.

Conventional pump pressure switch settings on SEARS pumps are as follows:

CUT IN/CUT OFF	PRECHARGE
20/40 PSI	20 PSI
30/50 PSI	30 PSI
40/60 PSI	40 PSI

NOTICE: For years of trouble free service, check pre-charge annually. See service hints (Page 7) for procedure.

NOTICE: Release and expel all air out of the piping system and the water reservoir portion of the Captive Air® Tank. This is required on new installations, pumps requiring repriming and pumps that have been apart for service. To accomplish this, open faucets farthest away from tank and start the pump. Observe the sputtering water flow from faucets. This is a mixture of air and water. Allow pump to run until there is a steady air free stream of water. Open and close faucets repeatedly until you are sure all air has been removed.

If air continues to remain in system, check for leaks in piping on suction side of pump system (Jet Pumps Only).

If you have a submersible pump, remove the bleeder orifices in the pipe (just below the well seal) and replace bleeder orifice with pipe plugs.

OPERATION

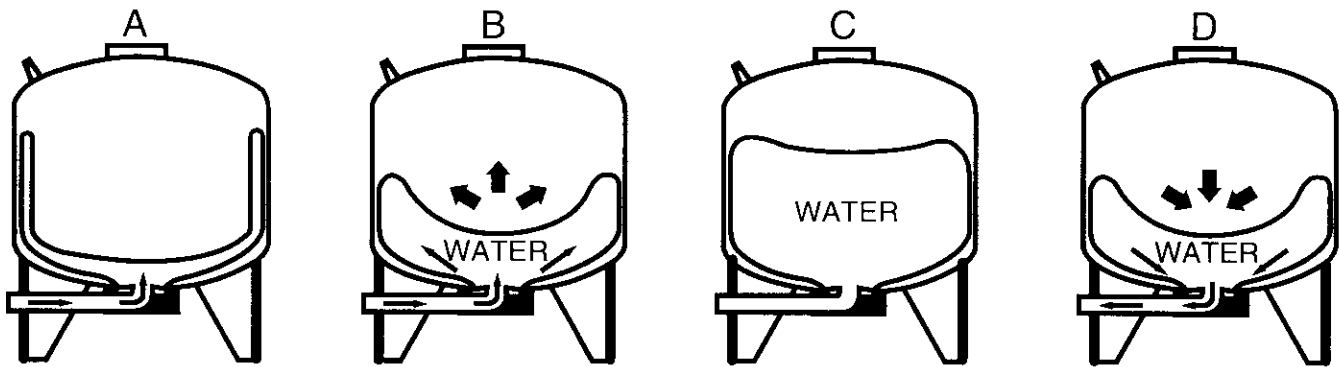

Tank is nearly empty:
Water storage bag is at bottom. Air expands to fill space above bag. The pump starts.

Water starts to fill the bag:
As bag fills, air above the bag is compressed.

Bag is full to capacity:
Air is compressed to the utmost for maximum draw-down. The pump stops.

Water is being drawn from the bag:
Compressed air in the tank forces water out.

FIGURE 10

SERVICE HINTS

NOTICE: To prevent waterlogging, check tank air charge annually.

TO CHECK TANK AIR CHARGE

If drawdown (amount of water that comes out of tank per pump cycle) decreases significantly, check as follows:

1. Check air charge in tank. Shut off electric power to pump, open faucet near tank, and drain completely.
2. At the air valve in top of tank, check air pressure with standard tire pressure gauge. Air pressure should be the same as pump pressure switch cut-in setting.
3. If the air pressure is below the cut-in setting, add air to the tank. Use an air compressor or a portable air storage tank.
4. Use soap or liquid detergent to check for air leaks around air valve. Continuous bubbling indicates a leak. If necessary, install new core in air valve. This is the same as those used for automobile tubeless tires.

TO CHECK PUMP PRESSURE SWITCH

1. Start the pump and allow the pressure switch to shut it off.
2. Check the tank air pressure with the tire gauge. It should be the same as the cut-off pressure for your system. (See "OPERATION" section on Page 6 for correct pressures).
3. If the pressure reading is different from your system recommended pressure, the switch should be replaced.

REPLACEMENT OF AIR VALVE

If air valve becomes broken, or leaks beyond repair, it may be necessary to replace it.

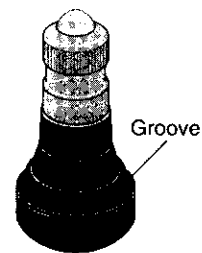

FIGURE 12

It is a standard tubeless tire valve which snaps in position in groove as it is pulled up thru hole from inside tank.

1. Disconnect power to pump.
2. Relieve (drain) ALL water in system by opening faucet closest to tank.
3. Relieve (expel) ALL air pressure in tank by removing core from inside of valve.
4. Disconnect outside piping only to tank.

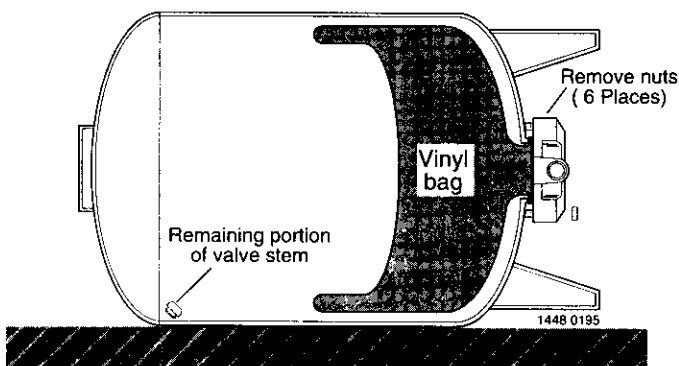

FIGURE 11

SERVICE HINTS

5. With sharp knife, cut off stem as close to tank as possible. Push remaining portion into tank.
6. Lay tank on side and remove six (6) nuts from studs. Tap cover to break seal and remove cover assembly from tank. You can now see the vinyl bag. See Figure 11.
7. Before removing vinyl bag from groove seat in tank, BE SURE all water is drained from bag. This can be accomplished by tipping tank upright and allowing remaining water to drain.
8. Carefully remove lip portion of bag from groove seat and push bag into tank.
9. Block up tank as shown in Figure 13. This will allow cut off portion of stem to slide down to bottom of tank. Reach in around bag until you find it and remove it.

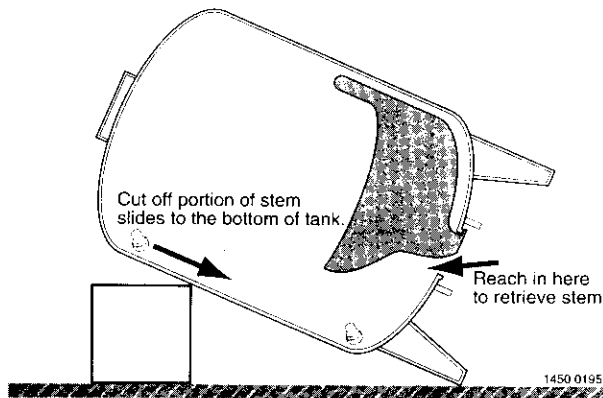

FIGURE 13

10. Wipe a thin film of soapy solution on top half of replacement stem and insert in stem hole in top of tank. It is necessary to use a valve stem pulling tool to pull stem thru opening. This tool is the same as used by your local filling station and Sears Automotive Center when servicing tubeless tires.
11. Pull neck of bag out of tank opening and seat in groove. BE SURE ring groove is clean.
12. Clean sealing surface of cover assembly and place on studs.
13. Hand tighten all nuts on studs.
CAUTION It is important that nuts be tightened as follows: First, hand tighten all nuts. Then tighten one nut to a snug fit. Next, tighten the one opposite to a snug fit. Proceed, tightening the others in opposite pairs to a snug fit. Recheck all nuts in same opposite patterns to be sure they are evenly tightened and you have a good seal. DO NOT overtighten, as you may twist the studs off the tank. With a torque wrench, tighten to 85 inch pounds.
14. Tip tank upright and assemble for operation.
15. Recharge tank with proper amount of air.

TESTING FOR LEAKAGE OF VINYL BAG

1. Disconnect power to pump.
2. Relieve (drain) ALL water in system by opening faucet closest to tank.
3. Relieve (expel) ALL air pressure in tank by removing core from inside of air valve.
4. Disconnect outside piping only to tank.
5. Turn tank upside down.

NOTICE: BE CAREFUL not to damage air valve when tipping tank. Removal of air valve is not required. If water leaks out of the valve core opening, the vinyl bag has a hole in it and must be replaced.

PROCEDURE FOR REPLACING VINYL BAG

WARNING Be sure all air has been expelled from tank before removing nuts.

FOR 6, 19 AND 36 GALLON TANKS

1. Carefully lay tank on its side.
2. Remove nuts around cover plate.
3. Tap cover to break the seal and remove cover assembly from tank. You can now see the vinyl bag.
4. Bag cannot be removed in one piece. Wherever convenient, grip bag with pliers and pull outward. At the same time cut bag with sharp knife or single-edged razor blade. Continue pulling and cutting until bag is completely removed.
5. Clean and dry inside of tank.

NOTICE: Before replacement bag can be inserted in tank, it must be tightly rolled up as follows:

1. Place bag on clean surface with opening up.
2. Flatten bag and force air out.
3. Tightly roll bag towards center opening.
4. Before center opening is covered up, force air out of remaining portion of bag.
5. Finish rolling bag.
6. As an aid for inserting bag in tank, sprinkle outside with talcum powder.
7. With tank upside down, push tightly rolled bag into tank.
8. Put your arm in bag and push sidewalls outward. It is NOT important that all wrinkles be removed.
9. Clean flange ring and groove of tank.
10. Pull lip of bag through tank opening and place in ring groove.
11. MAKE SURE it seals properly in groove.
12. Clean sealing surface of cover assembly and place on studs.

SERVICE HINTS

13. Install nuts and washers on studs. Hand tighten all nuts.

▲ CAUTION It is important that nuts be tightened as follows: First, hand tighten all nuts. Then tighten one nut to a snug fit. Next, tighten the one opposite to a snug fit. Proceed, tightening the others in opposite pairs to a snug fit. Recheck all nuts in same opposite patterns to be sure they are evenly tightened and you have a good seal. **DO NOT** overtighten, as you may twist the studs off the tank. With a torque wrench, tighten to 85 inch pounds.

14. Tip tank upright and reassemble for operation.

15. Recharge tank with proper amount of air.

FOR 50 AND 85 GALLON TANKS



Be sure all air has been expelled from tank before removing nuts.

1. Carefully lay tank on its side.
2. Remove nuts around cover plate.
3. Tap cover to break the seal and remove cover assembly from tank. You can now see the vinyl bag.
4. Bag cannot be removed in one piece. Wherever convenient, grip bag with pliers and pull outward. At the same time cut bag with sharp knife or single-edged razor blade. Continue pulling and cutting until bag is completely removed.
5. Clean and dry inside of tank.
6. Place bag on its side on dry clean surface.
7. Flatten bag and force air out.
8. Starting on one side, tightly roll bag to other side.

NOTICE: Before opening is rolled closed, force remaining air out.

9. Finish rolling bag.
10. As a aid for inserting bag in tank, sprinkle outside with talcum powder.
11. With tank on its side, push tightly rolled bag into tank opening.

NOTICE: Push bag in tank only the length of the rolled bag.

12. Insert arm in bag and push sidewalls outward. It is **NOT** important that all wrinkles be removed.
13. Clean flange ring and groove to tank.

NOTICE: Two people are required for the following steps:

14. Holding the bag, stand tank open end up.

NOTICE: **DO NOT** damage air valve. It may be of help to lean tank in corner.

15. Pull lip ring of bag through tank opening and place in ring groove.

16. **MAKE SURE** it seats properly in groove.

17. Clean sealing surface of cover assembly and place on studs.

18. Install nuts and washers on studs. Hand tighten all nuts.

NOTICE: It is important that nuts be tightened as follows: First, hand tighten all nuts. Then tighten one nut to a snug fit. Next, tighten the one opposite to a snug fit. Proceed, tightening the others in opposite pairs to a snug fit. Recheck all nuts in same opposite patterns to be sure they are evenly tightened and you have a good seal. **DO NOT** overtighten, as you may twist the studs off the tank. With a torque wrench, tighten to 85 inch pounds.

19. Tip tank upright and reassemble for operation.

20. Recharge tank with proper amount of air.

PUMP TO TANK FITTINGS PACKAGE NO. 2788

Pump to tank fittings Package No. 2788 is not furnished. You may purchase it at your local Sears Store.

Required to install all SEARS Captive Air® Tanks with shallow/deep well jet pump.

REPAIR PARTS

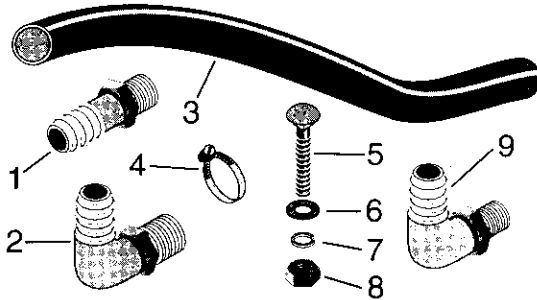

KEY NO.	PART NO.	PART DESCRIPTION
1	U78-777PA	Adapter - 1" NPT (Male) by 1" Insert (2 Req.)
2	U78-770P	Elbow - 3/4" NPT (Male) by 1" Insert
3	U74-37J	Hose
4	U19-55SS	Clamp - Hose (2 Req.)
5	U30-701ZP	Bolt - 3/8" - 16 x 1-3/4" Lg. (2 Req.)
6	U43-62ZP	Flat Washer - 3/8" (2 Req.)
7	U43-12ZP	Lock Washer - 3/8" (2 Req.)
8	U36-38ZP	Nut - Hex 3/8" - 16 (2 Req.)
9	U78-769P	Elbow - 1" NPT (Male) by 1" Insert (2 Req.)

CAPTIVE AIR® TANK (6 GALLON) MODEL 390.291198 (19 GALLON) MODEL 390.291358

REPAIR PARTS

KEY NO.	MODEL 390.291198 PART NO.	MODEL 390.291358 PART NO.	PART DESCRIPTION
•	U20-7	U20-13	Bag - Vinyl
1	U31-442P	-	Inlet Flange
1A	-	U31-446P	Inlet Flange
2	U36-202BT†	U36-202BT†	Nut 5/16 - 18 Hex (6 Req.)
3	-	U78-777PA	Adapter 1" NPT Male
3	U78-770P	-	Elbow - 3/4" NPT (Male) by 1" Insert
4	U212-160†	U212-160†	Air Valve w/Cap

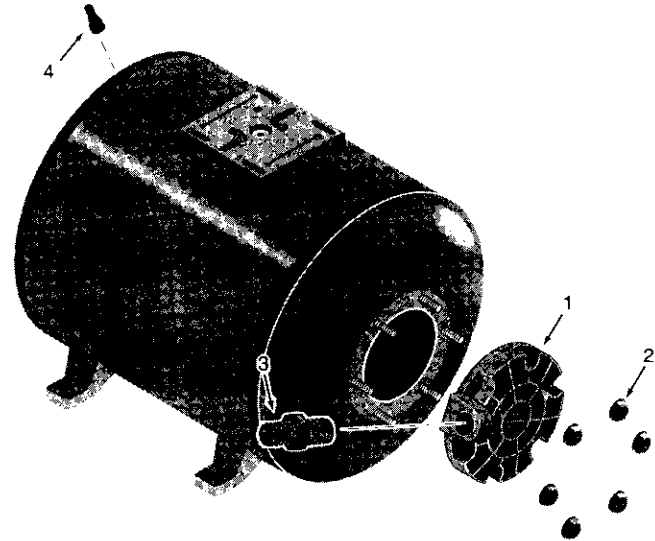

2878 0697

• Not Illustrated.

† Standard hardware item, may be purchased locally.

To order parts, call:
Sears Product Service
1-800-366-278

CAPTIVE AIR® TANK

MODEL 390.291558 (19 GALLON)

MODEL 390.291698 (50 GALLON)

MODEL 390.291658 (36 GALLON)

MODEL 390.291758 (85 GALLON)

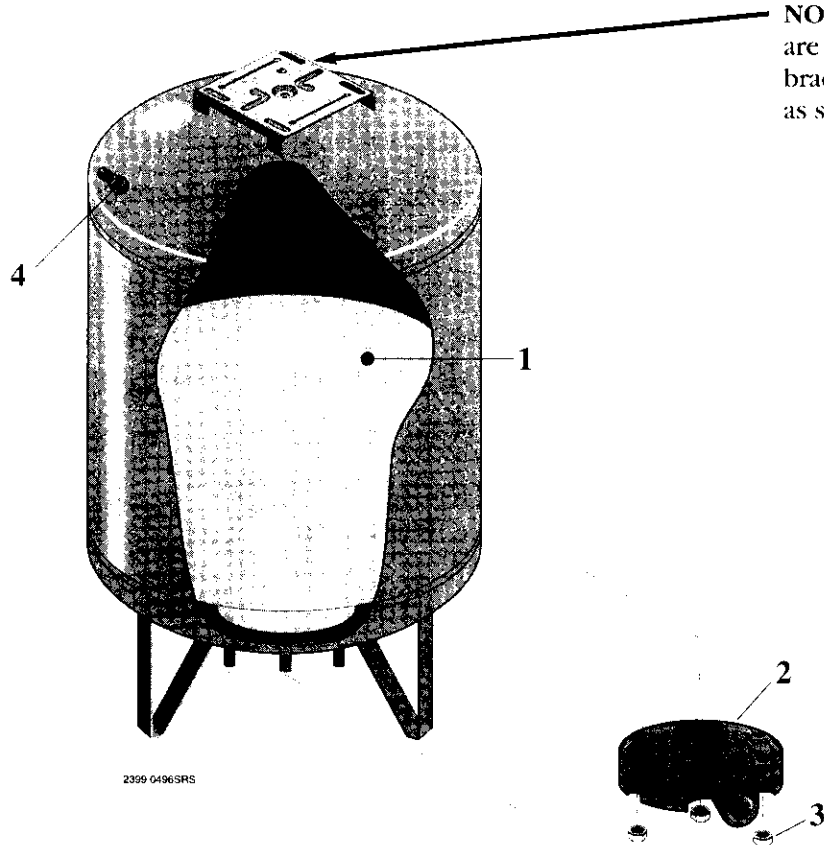

NOTICE: 50 and 85 gallon tanks are not equipped with mounting bracket. Install pump beside tank as shown on Page 5.

REPAIR PARTS

Key No.	390.291558 19 Gallon Tank	390.291658 36 Gallon Tank	390.291698 50 Gallon Tank	390.291758 85 Gallon Tank	Part Description
1	U20-8	U20-9	U20-10	U20-14	Bag - Vinyl
2	U31-446P	U31-446P	U31-447P	U31-447P	Inlet Flange
3	U36-202BT†	U36-202BT†	U36-202BT†	U36-202BT†	Nut - 5/16 - 18 Hex. (6 Req.)
4	U212-160†	U212-160†	U212-160†	U212-160†	Air Valve w/cap

†Standard hardware item, may be purchased locally.

To order parts, call:
Sears Product Service
1-800-366-7278

SEARS

OWNER'S MANUAL

Model No.

390.291198

390.291358

390.291558

390.291658

390.291698

390.291758

The model number of your Captive Air® Tank will be found on a label attached to the tank.

When requesting service or ordering parts, always give the following information:

- Product Type
- Model Number
- Part Number
- Part Description

CRAFTSMAN® CAPTIVE AIR® TANK

For the repair or replacement parts you need

Call 7 am - 7 pm, 7 days a week

1-800-366-PART

(1-800-366-7278)

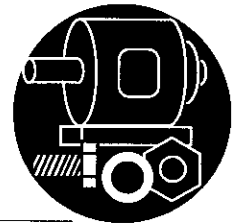

For in-home major brand repair service

Call 24 hours a day, 7 days a week

1-800-4-REPAIR

(1-800-473-7247)



For the location of a
Sears Repair Service Center in your area

Call 24 hours a day, 7 days a week

1-800-488-1222



For information on purchasing a Sears
Maintenance Agreement or to inquire
about an existing Agreement

call 9 am - 5 pm, Monday-Saturday

1-800-827-6655



SEARS
REPAIR SERVICES

America's Repair Specialists

Sears, Roebuck and Co., Hoffman Estates, IL 60179 U.S.A.

Free Manuals Download Website

<http://myh66.com>

<http://usermanuals.us>

<http://www.somanuals.com>

<http://www.4manuals.cc>

<http://www.manual-lib.com>

<http://www.404manual.com>

<http://www.luxmanual.com>

<http://aubethermostatmanual.com>

Golf course search by state

<http://golfingnear.com>

Email search by domain

<http://emailbydomain.com>

Auto manuals search

<http://auto.somanuals.com>

TV manuals search

<http://tv.somanuals.com>