

SEARS

OWNER'S MANUAL

Model No.
390.306062

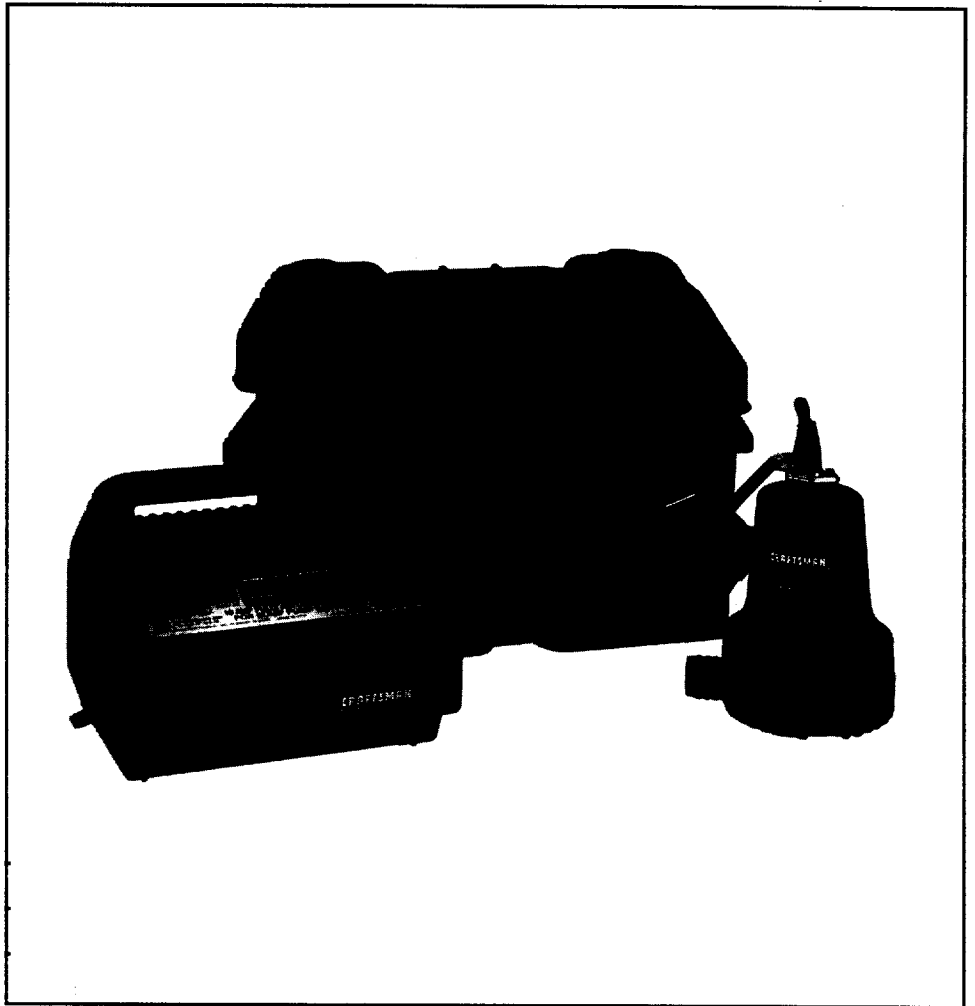

CAUTION:
Read and Follow
All Safety Rules and
Operating Instructions
Before First Use of
This Product.

Save This Manual For
Future Reference.

CRAFTSMAN® BATTERY OPERATED BACKUP SUMP PUMP

- Safety Instructions
- Operation
- Installation
- Troubleshooting
- Repair Parts

Sears, Roebuck and Co., Hoffman Estates, IL 60179 U.S.A.

CONTENTS

Introduction/Warranty	2
Safety	2
Performance	3
Charger Operation	3
Battery Requirements	4
Installation/Operation	4-5
Electrical	5-6
Service/Troubleshooting	6-7
Repair Parts	7

INTRODUCTION

Please take a few minutes to read our instructions before installing your Backup Sump Pump. It will help to assure perfect installation and help you avoid needless service expenses.

IMPORTANT SAFETY INSTRUCTIONS for BATTERY CHARGER

▲ WARNING Risk of electrical shock, fire, or explosion. Read all instructions in owner's manual and on charger, pump, and battery before using battery charger.

1. Unplug battery charger before attempting any cleaning. Turning off controls does not reduce the risk of electrical shock.
2. Charge only rechargeable 12-volt lead-acid batteries. Other types may burst when charged with this charger.
3. Do not let charger get wet.
4. Use only attachments recommended or sold by battery charger manufacturer.
5. When unplugging charger, grasp plug (not cord) to avoid risk of damage to cord or plug.
6. Locate cord so that it cannot be stepped on, tripped over, damaged, stretched, or flooded.
7. Do not modify cord or plug.
8. Do not attempt to service charger; it has no user-serviceable parts. If charger is dropped, struck, or otherwise damaged, take it to a qualified service technician.

SAVE THESE INSTRUCTIONS

FULL ONE-YEAR WARRANTY ON CRAFTSMAN BATTERY BACK-UP SUMP PUMP
 For one year from the date of purchase, Sears will repair or replace this pump, free of charge, if defective in materials or workmanship.

LIMITED WARRANTY ON CRAFTSMAN BATTERY BACK-UP SUMP PUMP
 After one year from the date of purchase, Sears will furnish the materials and charge a replacement part for any defective parts. You pay labor.

This warranty does not cover the pump or its components because of abuse or negligence, including failure to follow instructions, or if the pump is used for purposes not intended in the owner's manual.

LIMITATION OF LIABILITY
 SEARS WILL NOT BE LIABLE FOR ANY DAMAGE TO PROPERTY OR FOR INCIDENTS OR CONSEQUENTIAL LOSS OR EXPENSES, INCLUDING PROPERTY DAMAGE, DIRECTLY OR INDIRECTLY FROM THE USE OF THIS PRODUCT.

Some states do not allow the exclusion or limitation of incidental or consequential damages, so the above limitation or exclusion may not apply to you.

WARRANTY SERVICE IS AVAILABLE BY SIMPLY CONTACTING THE NEAREST SEARS SERVICE CENTER/DEPARTMENT IN THE UNITED STATES.

This warranty applies only to the original purchaser in the United States.
 This warranty does not apply to the pump and may also vary, our pump will vary from state to state.

Sears, Roebuck and Co., Dept. 817-47, Hoffman Estates, IL 60179

RULES FOR SAFE INSTALLATION AND OPERATION

Carefully read and follow all safety instructions in this manual or on pump.

▲ This is the safety alert symbol. When you see this symbol on your pump or in this manual, look for one of the following signal words and be alert to the potential for personal injury!

▲ DANGER DANGER warns about hazards that will cause serious personal injury, death or major property damage if ignored.

▲ WARNING WARNING warns about hazards that can cause serious personal injury, death or major property damage if ignored.

▲ CAUTION CAUTION warns about hazards that will or can cause minor personal injury or property damage if ignored.

The word NOTICE indicates special instructions which are important but not related to hazards.

1. To avoid risk of serious bodily injury and property damage, read safety instructions carefully before installing pump.
2. Follow local and/or national plumbing and electrical codes when installing pump. A ground fault circuit interrupter (GFCI) is recommended for use on any electrical appliance submerged in water.

3. Use this pump only for backup sump pump duty in a residential application. It is not designed as a primary sump pump.
4. **⚠ WARNING Hazardous Voltage.** Can cause severe or fatal electrical shock. Do not plug in or unplug battery charger while standing on a wet floor or in water. Be sure one hand is free when plugging in or unplugging charger. If basement floor is wet, disconnect power to basement before walking on floor.
5. Do not lift pump by electrical cord.
6. Pump water only with this pump.
7. Do not run pump dry. To do so will damage seals and can cause leaking and property damage.
8. Pump is permanently lubricated at the factory. Do not try to lubricate it!
9. Keep battery charger and battery box in a dry, cool, well ventilated area.
10. To avoid danger of fire or explosion, keep sparks and flame away from battery.
11. **⚠ WARNING Battery acid is corrosive.** Do not spill on skin, clothing, or battery charger. Wear eye protection when working on battery.
12. Maximum vertical pumping distance is 15 feet.
13. Make sure sump is clear of debris.

BASIC TOOLS AND MATERIALS NEEDED

Pipe Wrenches	Screwdriver
Hacksaw	1-1/4" Check Valve
Adjustable Wrench	Teflon Tape
Knife	12-volt Battery

GENERAL INFORMATION

The Battery-Powered Back-up Sump Pump is not a substitute for your primary sump pump. It is designed as a backup pump to pinch-hit for your primary sump pump during a power outage or other problem which prevents normal operation. Do not use it to pump flammable liquids or chemicals.

Keep battery charger dry and protected from damage.

In an emergency (such as an extended power outage) which depletes the system battery, your automobile battery may be temporarily substituted. Be sure to replace the system battery as soon as possible.

CHARGER OPERATION

Backup pump will start automatically when sump water level rises far enough to trip float switch. After a delay of about 4 seconds, alarm will sound. Silence alarm by pushing ALARM TEST/RESET button. In normal (switch actuated) operation, alarm is locked out until about 4 seconds after float switch has dropped to OFF position; cycle can then begin again.

Test alarm by pushing ALARM TEST/RESET button when alarm is not sounding. Alarm will then sound as long as button is held down. Pushing ALARM TEST/RESET button to test alarm overrides lockout, so alarm can be tested at any time.

If alarm sounds, check operation of primary pump, which may need service. If battery backup operation is due to a power outage, alarm will sound, but no service is likely to be required to primary pump.

Battery charger has capacity to run pump and charge battery at the same time as long as power to the charger is not interrupted. If power to charger circuit is interrupted, the length of time that the backup pump will run depends on the Ampere-hour capacity of the battery used.

Extended periods of operation (for example, during an extended power outage) may exhaust the battery. However, once the load is removed, usually it will self-regenerate far enough to allow the charger to start. The battery charger will begin charging the battery as long as the battery has a charge of at least 1/2 volt, and power is available to the charger.

After power is restored, charger will automatically re-charge battery fully in about six hours.

NOTICE: Some trouble conditions will cause the alarm to sound. See chart below for causes and action:

PROBLEM	ACTION
Back-up pump has run	Push 'Reset'. Check main pump.
Power out more than 24 hours	Disconnect charger from battery. Call power company.
Continuous charging more than 24 hours	Disconnect charger from battery. Check for defective battery.
Loose connection or no power to charger	Disconnect charger from battery. Check plug, receptacle, and power at main breaker.

After restoring power or replacing battery, alarm can be reset.

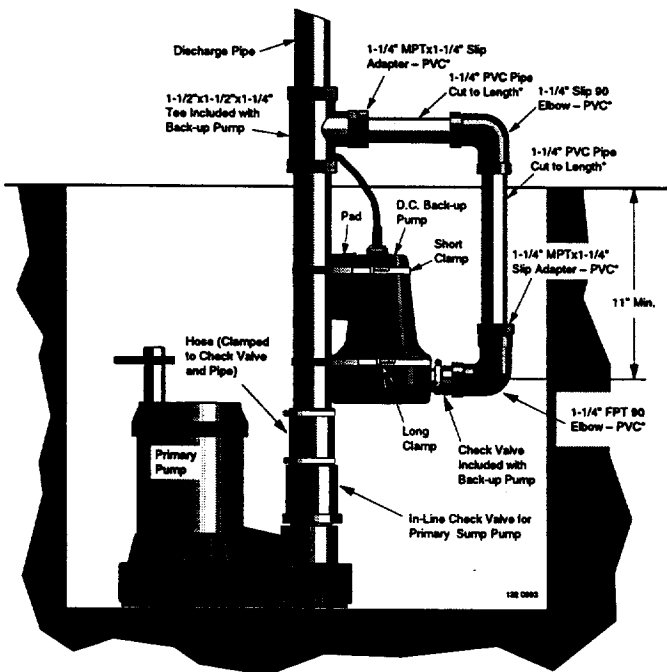

* Purchase locally.

For small/shallow sump pits install as illustrated above. Installation Kit 2785 includes the necessary clamps and support pad needed for this installation. Follow other instructions in the owner's manual.

Figure 1 – Installation in small or shallow sumps – use Kit 2785; sump diameter is exaggerated for clarity.

TABLE I Performance Chart/Sears DieHard Size 24M or 27M

	VERTICAL PUMPING DISTANCE					
	8 FEET		10 FEET		12 FEET	
Battery Size	27M	24M	27M	24M	27M	24M
Gallons Per Minute	18.0	18.0	14.5	14.5	11.5	11.5
Hours Available	9.6	8.3	9.9	8.3	6.8	5.7
Total Gallons Pumped	7,212	6,055	5,557	4,939	3,727	3,189

BATTERY REQUIREMENTS

▲ WARNING Hazardous electrical current. Can cause severe burns and start a fire if battery terminals are short circuited. Install battery in box. To prevent accidental shorting across battery terminals, strap cover securely on battery box. Do not leave battery uncovered. Do not allow children to play around sump pump installation.

Your Backup Sump Pump depends on the battery used with it for power. The better the battery, the better the performance of the pump. We recommend use of a SEARS DieHard Size 27M or 24M Deep-Cycle Marine battery. This battery will perform well for many hours and stands up well to long periods of little or no use.

In an emergency a SEARS DieHard Size 27M or 24M standard automobile battery may be used. However, an automotive battery may require charging after only 1 to 2 hours of continuous use, and the repeated charging cycles may cause early plate failure in the battery.

Use only a new, fully charged battery that will fit in the battery box (maximum size 12-5/8" long, 7" wide and 9-3/8" high including terminals).

PUMP INSTALLATION and OPERATION

NOTICE: We recommend a trial fitting of all components before gluing anything. This will allow you to check pump mounting height, float switch clearance, etc., while adjustments can still be easily made.

1. Mark side of sump six inches down from top.
2. Fill sump until primary sump pump starts; normal high water level should not be above mark made in step 1. If it is higher, backup float switch may not swing far enough for proper operation. To lower high water level, adjust switch on primary sump pump. See primary pump owner's manual.
3. Drain sump. Measure down 11 inches from top of sump; mark this point on side of sump. Install tee with center of threaded inlet at least this far below top of sump to allow sufficient room for float switch to swing (see Figure 2A).
4. Make sure that installation will not interfere with primary sump pump operation as follows:
 - A. Backup pump installation must not interfere with primary sump pump float switch swing.
 - B. Normal high water level must never be high enough to start backup sump pump.
 - C. Install a check valve (SEARS Stock No. 2789) in the main sump pump discharge pipe between the pump and the backup mounting tee (see Figures 2A and 2B).

Flow through this check valve must be away from the main sump pump; don't install it backwards! This check valve will prevent recirculation into the sump during battery-powered pump operation.

5. Cut rigid discharge pipe from primary sump pump to length. Use PVC piping. Tee supplied is 1-1/2" slip fit; if necessary use 1-1/4" bushings supplied.

NOTICE: Use any tee that fits sump pump discharge line; the adapter that is supplied (Key No. 10, Page 7) will fit any galvanized or plastic 1-1/4" tee. Do not glue the tee until all parts have been trial fitted.

6. Thread adapter into tee (Figure 2B). When installed, molded-in 'up' should be on top.
7. Install backup pump check valve in adapter. Tab on backup pump check valve fits into notch at top of adapter.
8. For trial assembly, slip pump into backup pump check valve to check pump mounting height and to make sure that there is no interference with float switch operation on either pump; be sure floats will not rub on side of sump, catch between pump and sump wall, interfere with each other, etc.
9. Remove pump from adapter; remove tee.
10. Using PVC glue, permanently reinstall tee in primary sump pump discharge pipe.

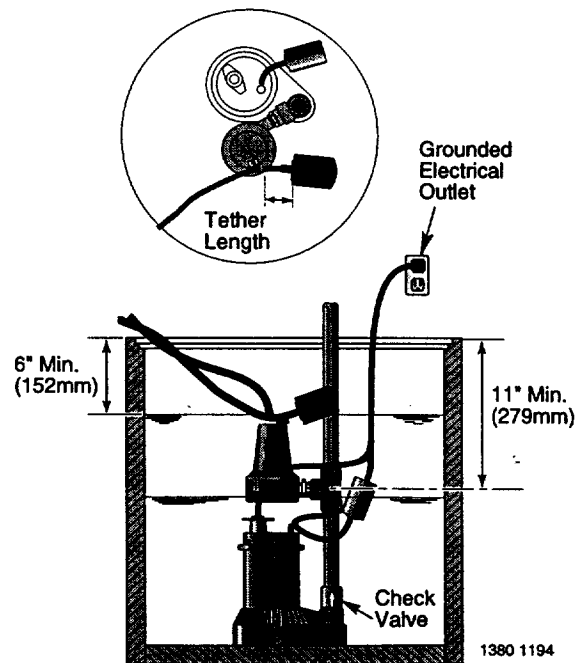
**Figure 2A - Standard Installation**

⚠ WARNING Hazardous fumes. Follow cement manufacturer's instructions. Use PVC cement only in a well ventilated place away from fire or flame.

11. Put clamp on adapter; leave loose. Mount check valve in adapter; thread assembly into tee.
12. Slip pump into check valve. Tighten clamp.

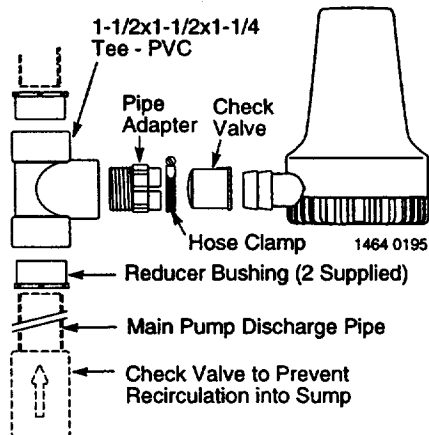

Figure 2B – Installation Diagram

13. Make sure battery is fully charged; then check operation by disconnecting power to primary sump pump and filling sump until Backup Sump Pump starts. Run Backup Pump through one complete cycle.

ELECTRICAL CONNECTIONS

⚠ WARNING Hazardous voltage. Can cause serious or fatal electrical shock. Review safety instructions, Page 2, before operating charger.

If your outlet is not grounded, install a copper wire (at least 14 gauge) from the outlet box to a cold water pipe. Use ground clamp on pipe. BE SURE that the cold water pipe used has metal continuity to electrical ground. Battery charger is double insulated. DO NOT modify cord or plug.

CHARGER/BATTERY INSTALLATION

NOTICE: Alarm will sound when charger is first connected to battery. Press ALARM TEST/RESET button on charger. If alarm continues to sound, disconnect one charger lead from the battery and reconnect it. Press ALARM TEST/RESET again; alarm will stop sounding.

1. Connect charger as shown in Figure 3.
 - A. Connect Positive (+) lead from charger to positive battery post.
 - B. Connect Negative (-) lead from charger to negative battery post.
 - C. Third lead from charger is factory connected to lead from pump motor/float switch.

NOTICE: If charger is connected backwards, pump will not operate properly, battery will not charge.

2. Plug in power cord to a 115-125 Volt AC outlet delivering at least 2 amps. Do not use a switch controlled outlet. Mark circuit in main power panel "Backup sump pump power supply; do not turn off".

3. With charger properly connected and plugged in, the panel on the front of the charger will appear as in one of the following:

- A. If battery is dead, charger will supply about 10 amps power (see Figure 4A).
- B. If battery is near full charge, charger will deliver about 5 amps power (see Figure 4B).

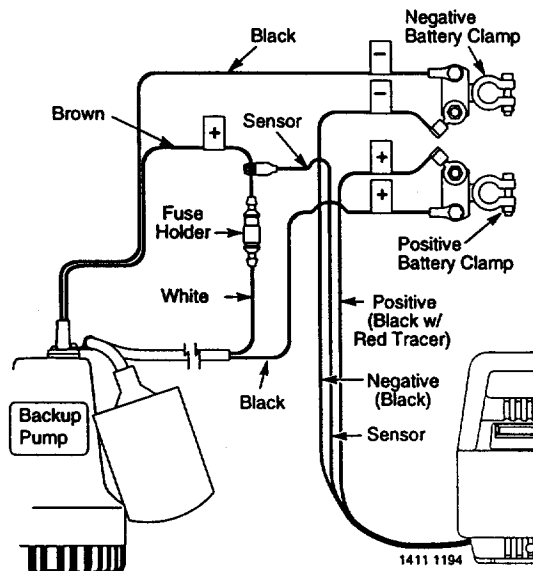
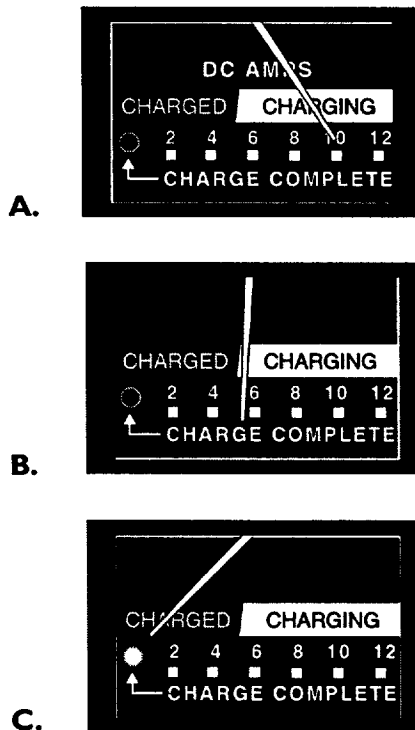

Figure 3 – Wiring Connections



1413 1194

Figure 4 – Battery Backup Control Panel

- A. Battery depleted - charging current 10 amps.
- B. Battery nearly charged - current about 5 amps.
- C. Charge complete - current 0 amps, LED lights up.

- C. If battery is fully charged, charging current will be 0 amps and green LED lamp will be lighted (see Figure 4C).
4. The charger is equipped with a self-resetting circuit breaker which protects it from temporary overloads. In case of an overload, the circuit breaker will open. It automatically resets after a short cool-down period. In some conditions where the overload is extended the breaker will cycle, repeating the open/reset process indefinitely. When this happens, normally the charger will emit a clicking sound as the breaker opens and resets.

NOTICE: If the clicking sound continues for more than 30 minutes or so, check for reversed charger connections to the battery and for shorted cells in the battery.

BATTERY MAINTENANCE

NOTICE: To protect battery case from chipping and gouging, do not let battery sit on concrete floor. Install battery on a shelf or protective pad (plywood, 2x4s, etc.). Always install battery in a dry location that is protected from flooding. Every three months, check battery as follows to maintain battery in best condition:

1. Unplug battery charger.
2. On batteries with removable top caps, measure specific gravity of the electrolyte. Use a hydrometer (available at auto parts stores). If the specific gravity of any cell is less than 1.225 or if there is more than .050 variation between cells, replace the battery.
3. Check electrolyte level and refill as needed.
4. Check battery terminals and clamps for tightness and corrosion. Clean and tighten as needed.
5. Plug in battery charger.

TROUBLESHOOTING

Pump won't run.

1. Check all connections.
2. Check for low or defective battery.
3. Check that automatic switch is free to swing up and down.
4. Blown fuse in switch circuit. Unplug pump and check to see if impeller is free to turn. If impeller is locked, remove the housing around the impeller and remove the obstruction. Reassemble pump and reconnect. Replace fuse.

Motor hums but pump won't run:

1. Check for low or defective battery.

Pump runs but pumps very little or no water:

1. Make sure a check valve is installed and functioning between primary pump discharge and Backup Sump Pump tee.
2. Check for obstruction in discharge pipe.
3. Discharge pipe length and/or height exceeds capacity of pump. See Table I, Page 4, for pump capacity.
4. Check for low or defective battery.

Pump cycles too frequently:

1. Tether length too short on automatic float switch. Make sure that tether is at least 2"; see Figure 2.

2. Main check valve located between discharge of primary pump and the Backup Sump Pump tee or check valve not installed or working properly. Install or repair as required.

SWITCH REPLACEMENT

1. Unplug battery charger from wall outlet.
 2. Disconnect both battery clamps from battery terminals.
 3. Unbolt black switch wire from battery clamp.
 4. Unplug fuse holder in white wire; save fuse.
 5. Make a note of tether length (see Figure 2) before loosening cord clamp.
 6. Remove cord from cord clamp and replace with new cord. Make sure tether length is the same as the old switch's tether.
 7. Strip insulation off of white wire on new switch, leaving 3/8" bare wire exposed at the wire end (see Figure 5).
 8. Insert stripped wire end in small end of fuse holder half; crimp holder onto wire and check crimp for tightness (Figure 6).
- NOTICE:** Be sure that fuse holder half which you are installing will mate with fuse holder half on pump wire.
9. Insert fuse into holder and snap halves of housing together (Figure 7).
 10. Remount block on band and cord clamp assembly on pump.
 11. Strip black switch wire back 3/8" from end of wire. Crimp wire terminal onto end of wire and check for tightness.
 12. Bolt black switch wire onto battery terminal clamp.

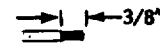

Figure 5

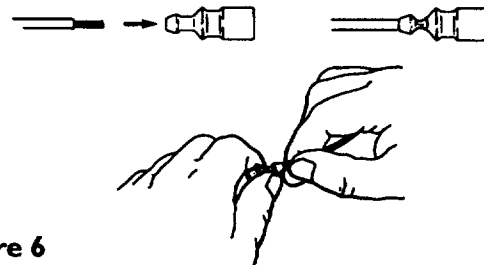

Figure 6

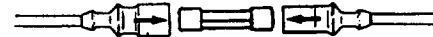

Figure 7

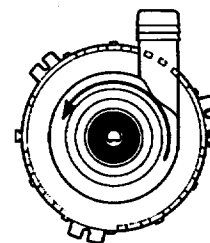

Figure 8

13. Reinstall battery clamps:

A. Black switch wire clamps to positive battery terminal.

B. Black pump wire clamps to negative battery terminal.

NOTICE: DO NOT reverse terminal connections.

14. Turn pump upside down; unclip and remove screen. Do not remove screw-mounted bottom plate. Lift switch to momentarily "bump" pump. Check for correct operation and rotation (pump must rotate counter-clockwise when looking at end of shaft - Figure 8). If not, reverse wires to battery and recheck.

15. Replace screen.

16. Plug in charger to wall outlet.

17. Fill sump with water and check switch action. Adjust tether if necessary.

CAUTION DO NOT test run pump for more than 5 seconds without water in it. Running pump dry for extended periods could damage pump and voids warranty.

Craftsman Battery Backup Sump Pump Model 390.306062

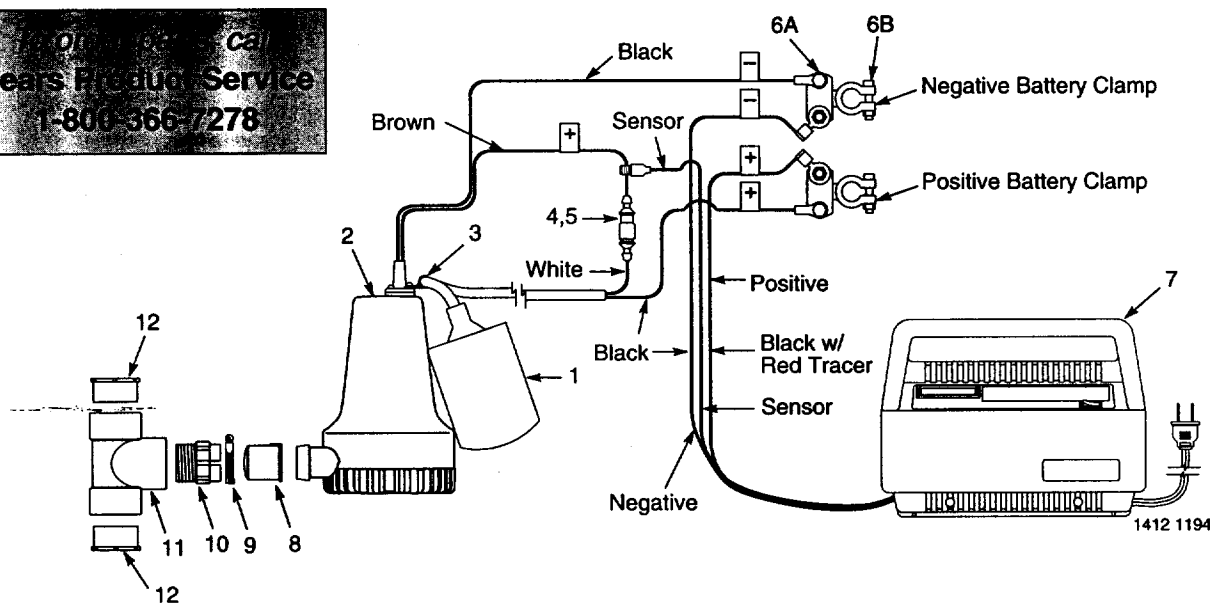
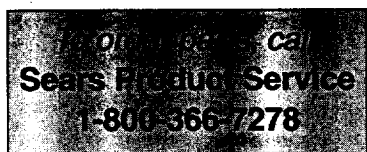

REPAIR PARTS LIST

Key No.	Part No.	Part Description
1	PS217-5E	Switch Assembly #
2	PS17-41	Pump Complete***
3	CC0030-13	Cord Clamp
4	U17-1148	Fuse Holder
5	U17-1149	15-Amp Time-Delay Fuse (2 supplied †)
6A	**	Wire Terminal (4 Req.)
6B	**	Battery Terminal Clamps (2 Req.)
*	PS17-100	Battery Case (includes strap and strap brackets)
7	PS117-77A	Charger***
8	PS22-1	Check Valve
9	**	Hose Clamp 1" min. - 2" max. S.S.
10	PS78-3P	Pipe Adapter
11	U78-846P	Tee 1-1/2 x 1-1/2 x 1-1/4 PVC
12	U78-876P	Reducer Bushing (2 Req.)

When ordering, also order Key Nos. 4 (Fuse Holder) and 5 (Fuse) required for installation.

* Not illustrated.

** Standard Hardware Item; purchase locally.

*** No component parts available for pump or battery charger.

† Second fuse is supplied as spare.

SEARS

OWNER'S MANUAL

Model No.
390.306062

The model number of your Backup Sump Pump will be located on the pump, not the battery charger.

When requesting service or ordering parts, always give the following information:

- Product Type
- Model Number
- Part Number
- Part Description

CRAFTSMAN® BATTERY OPERATED BACKUP SUMP PUMP

For the repair or replacement parts you need

Call 7 am - 7 pm, 7 days a week

1-800-366-PART

(1-800-366-7278)

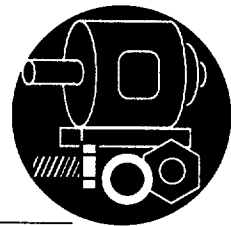

For in-home major brand repair service

Call 24 hours a day, 7 days a week

1-800-4-REPAIR

(1-800-473-7247)



For the location of a
Sears Repair Service Center in your area

Call 24 hours a day, 7 days a week

1-800-488-1222



For information on purchasing a Sears
Maintenance Agreement or to inquire
about an existing Agreement

call 9 am - 5 pm, Monday-Saturday

1-800-827-6655



SEARS
REPAIR SERVICES
America's Repair Specialists

Sears, Roebuck and Co., Hoffman Estates, IL 60179 U.S.A.

Free Manuals Download Website

<http://myh66.com>

<http://usermanuals.us>

<http://www.somanuals.com>

<http://www.4manuals.cc>

<http://www.manual-lib.com>

<http://www.404manual.com>

<http://www.luxmanual.com>

<http://aubethermostatmanual.com>

Golf course search by state

<http://golfingnear.com>

Email search by domain

<http://emailbydomain.com>

Auto manuals search

<http://auto.somanuals.com>

TV manuals search

<http://tv.somanuals.com>