

Owner's Manual

**CRAFTSMAN®**

Double Insulated

# **BUFFER/POLISHER SYSTEM**

Model No. 646.106591

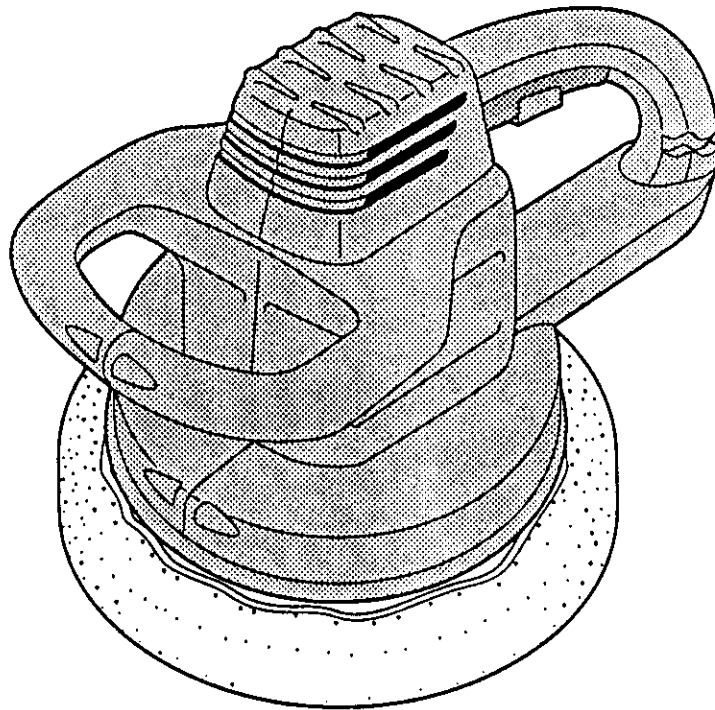

## **CAUTION:**

Read and follow all safety rules and operating instructions before first use of this product.

- Safety Rules
- Operation
- Maintenance
- Accessories
- Español

**Save this manual for future reference.**

**Sears, Roebuck and Co., Hoffman Estates, IL 60179 USA**

Visit our Craftsman website: [www.sears.com/craftsman](http://www.sears.com/craftsman)

# SAFETY RULES



**WARNING:** Read and understand all instructions.

Failure to follow all instructions listed below may result in electric shock, fire and/or serious personal injury.

**SAVE THESE INSTRUCTIONS.**

## WORK AREA

- Keep your work area clean and well lit. Cluttered benches and dark areas invite accidents.
- Do not operate power tools in explosive atmospheres, such as in the presence of flammable liquids, gases, or dust. Power tools create sparks which may ignite the dust or fumes.
- Keep bystanders, children, and visitors away while operating a power tool. Distractions can cause you to lose control.

## ELECTRICAL SAFETY

- Double insulated tools are equipped with a polarized plug (one blade is wider than the other.) This plug will fit in a polarized extension cord only one way. If the plug does not fit fully in the outlet, reverse the plug. If it still does not fit, contact a qualified electrician to install a polarized outlet. Do not change the plug in any way to make it fit your extension cord. Double insulation eliminates the need for the three-wire grounded power cord and grounded power supply system.
- Avoid body contact with grounded surfaces such as pipes, radiators, ranges and refrigerators. There is an increased risk of electric shock if your body is grounded.
- Don't expose power tools to rain or wet conditions. Water entering a power tool will increase the risk of electric shock.
- Do not abuse the extension cord. Never use the cord to carry the tools or pull the plug from an outlet. Keep cord away from heat, oil, sharp edges or moving parts. Replace damaged cords immediately. Damaged cords increase the risk of electric shock.
- When operating a power tool outside, use an outdoor extension cord marked "W-A" or "W." These cords are rated for outdoor use and reduce the risk of electric shock.

## PERSONAL SAFETY

- Stay alert, watch what you are doing and use common sense when operating a power tool. Do not use tool while tired or under the influence of drugs, alcohol, or medication. A moment of inattention while operating power tools may result in serious personal injury.
- Dress properly. Do not wear loose clothing or jewelry. Contain long hair. Keep your hair, clothing, and gloves away from moving parts. Loose clothes, jewelry, or long hair can be caught in moving parts.
- Avoid accidental starting. Be sure switch is off before plugging in. Carrying tools with your finger on the switch or plugging in tools with the switch on invites accidents.
- Do not overreach. Keep proper footing and balance at all times. Proper footing and balance enables better control of the tool in unexpected situations.
- Use safety equipment. Always wear eye protection. Dust mask, non-skid safety shoes, hard hat, or hearing protection must be used for appropriate conditions.

## TOOL USE AND CARE

- Use clamps or other practical ways to secure and support the workpiece to a stable platform. Holding the work by hand or against your body is unstable and may lead to loss of control.
- Do not force tool. Use the correct tool for your application. The correct tool will do the job better and safer at the rate for which it is designed.
- Do not use tool if switch does not turn it on or off. A tool that cannot be controlled with the switch is dangerous and must be repaired.
- Disconnect the plug from the power source before making any adjustments, changing accessories, or storing the tool. Such preventive safety measures reduce the risk of starting the tool accidentally.

## TOOL USE AND CARE

- Store idle tools out of reach of children and other untrained persons. Tools are dangerous in the hands of untrained users.
- Maintain tools with care. Properly maintained tools are less likely to bind and are easier to control.
- Check for misalignment or binding of moving parts, breakage of parts, and any other condition that may affect the tool's operation. If damaged, have the tool serviced before using. Many accidents are caused by poorly maintained tools.

- Use only accessories that are recommended by the manufacturer for your model. Accessories that may be suitable for one tool may create a risk of injury when used on another tool.

## SERVICE

- Tool service must be performed only by qualified repair personnel. Service or maintenance performed by unqualified personnel may result in a risk of injury.
- When servicing a tool, use only identical replacement parts. Follow instructions in the maintenance section of this manual. Use of unauthorized parts or failure to follow maintenance instructions may create a risk of electric shock or injury.

## OPERATION

Before you begin, make sure your car is clean and dry. The work area should be dry also. If necessary, remove road tar with a general cleaner before polishing. Also, remove excess grease spots, bug stains, etc.

**NOTE:** The Wax & Polishing Solution containers shown in the illustrations are representative. Yours may look different.

### A

Place the blue wax applicator bonnet on pad as shown. Make sure the elastic is tucked down securely and evenly around the underside of the pad.

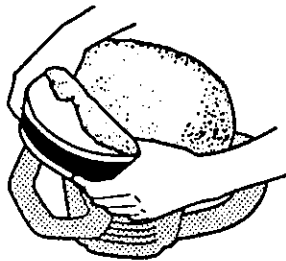

### B FOR PASTE WAX

Spread about a heaping teaspoonful of wax evenly over the entire surface of the wax applicator bonnet. Use a putty knife or any flat object. **DO NOT APPLY WAX DIRECTLY TO CAR.**

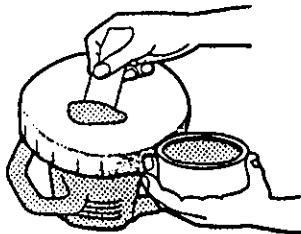

### C FOR LIQUID WAX

Apply three swirls of liquid wax on the wax applicator bonnet. **DO NOT APPLY WAX DIRECTLY TO CAR.** This first application should do about 1/4 of the car. For the second and third applications of wax, use half the quantity stated above. The bonnet will not absorb as much when reloading.

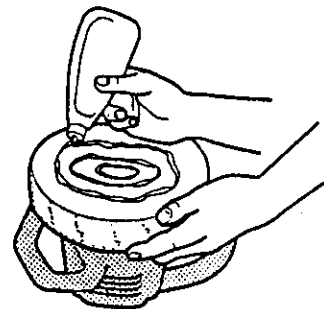

### D

The polisher is turned on and off by squeezing and releasing the trigger switch. The LOCK button on the trigger switch can be used to lock the machine in ON position while it is running. To lock, depress the LOCK button as you release the trigger switch. To release LOCK, press the trigger switch.

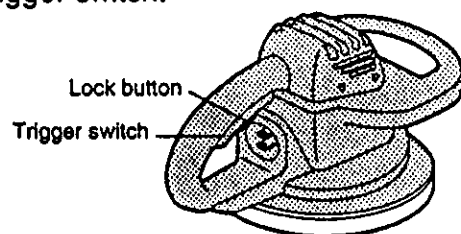

**E**

There is a cord lock feature on the handle to prevent the extension cord from detaching during use. Plug the cord into the unit, then secure the cord as shown.

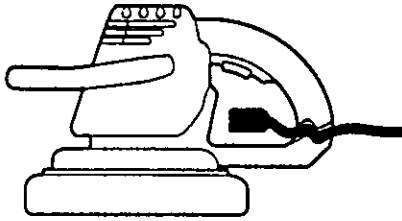
**F**

**ALWAYS START AND STOP THE POLISHER ON OR AGAINST THE CAR SURFACE.**

Place the extension cord over your shoulder and do flat surfaces first—hood, trunk and roof. Cover areas quickly with broad, sweeping strokes in a criss-cross pattern.

**DO NOT press down on the polisher.** The machine's action, not pressure, does the best job.

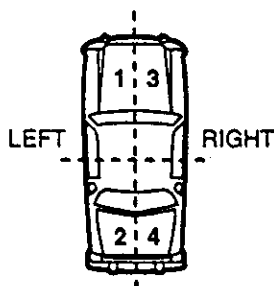
**G**

After flat surfaces are covered with wax, do sides of the car. Hold the polisher as shown. Let the cord hang free. It is not necessary to use a criss-cross motion on doors and fenders.

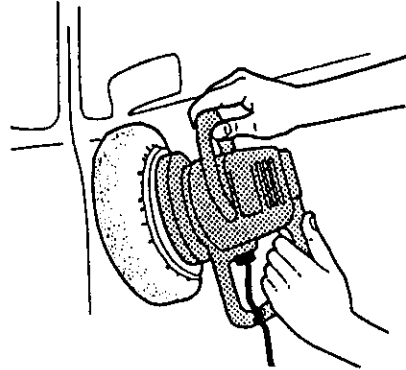
**H**

Remove the wax applicator bonnet and use it to hand-polish all hard-to-reach surfaces; under the bumpers, around the door handles, etc.

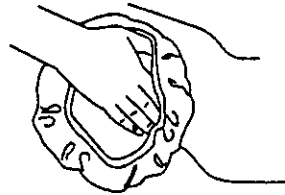
**I**

Throw away the wax applicator bonnet and put a clean terrycloth bonnet on the polisher.

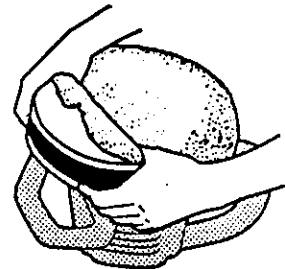
**J**

Polish the wax in the same order it was applied. Use long, sweeping strokes in a criss-cross pattern. Do not press hard. Let the polisher do the work.

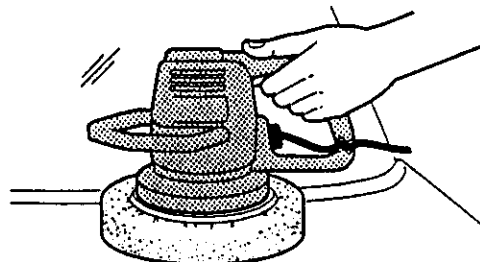

## CARE AND MAINTENANCE

- Terrycloth bonnets are 100% cotton and can be machine-washed in cold water with a small amount of detergent, then machine-dried at low heat. However, hand-washing and **air drying** is recommended for longer terrycloth bonnet life.
- Wax applicator bonnets are to be used only **once**, then thrown away.
- To prolong pad life and shape, **always store polisher with pad face up**.
- Remove bonnet from pad when polisher is not in use so that pad can dry out and retain its original shape.
- Badly oxidized paint may require several applications. **DO NOT USE ABRASIVE COMPOUNDS.**
- The most common error is applying too much wax. If pad becomes saturated, it will not last as long, and **polishing will be more difficult and take longer.**
- If applicator bonnet continually comes off pad, you may be using too much wax.
- If buffing seems difficult, you may have used too much wax.
- Use only mild soap and a damp sponge to clean polisher. Do not immerse any part in liquid. If polisher needs repair, use only identical replacement parts illustrated and listed on Page 6.
- The lamb's wool bonnet is only to be used for the final buff. Do not use it to apply or remove wax.
- Lamb's wool bonnets can be cleaned by hand washing in lukewarm water and mild detergent; then machine dry at the lowest setting.

### TO REPLACE PAD ASSEMBLY

1. Insert screwdriver through aperture between polisher and pad, and brace against counterweight.

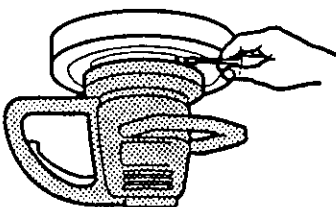

2. Remove center bolt with 1/2" deep well socket wrench, turning clockwise.

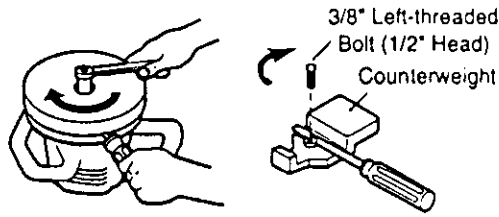

3. Replace pad assembly and turn bolt counterclockwise.

### CARTON CONTENTS

- Buffer/Polisher (1) 120VAC, .80 amps
- Wax Applicator Bonnet (1)
- Terrycloth Bonnet (1)

### AVAILABLE ACCESSORIES

Item	Stock#
100% Lamb's Wool Bonnet (1)	10604
Terrycloth Bonnets (2)	10603
Wax Applicator Bonnets (4)	10609
Cleaner/Glaze (8 oz.)	10996
Clear Pro™ Wax (8 oz.)	10995
Wax (8 oz.)	10998

### FULL ONE YEAR WARRANTY

If this product fails due to a defect in material or workmanship within one year from the date of purchase, Sears will at its option repair or replace it free of charge. Return this product to a Sears Service Center for repair, or to place of purchase for replacement. **Note:** Bonnets and foam sponge rubber pad are expendable items and are not covered by this warranty.

If this product is used for commercial purposes, this warranty applies for only 90 days from the date of purchase.

This warranty gives you specific legal rights, and you may also have other rights which vary from state to state.

**Sears Roebuck and Co., Dept. 817WA,  
Hoffman Estates, IL 60179**

# PARTS LIST

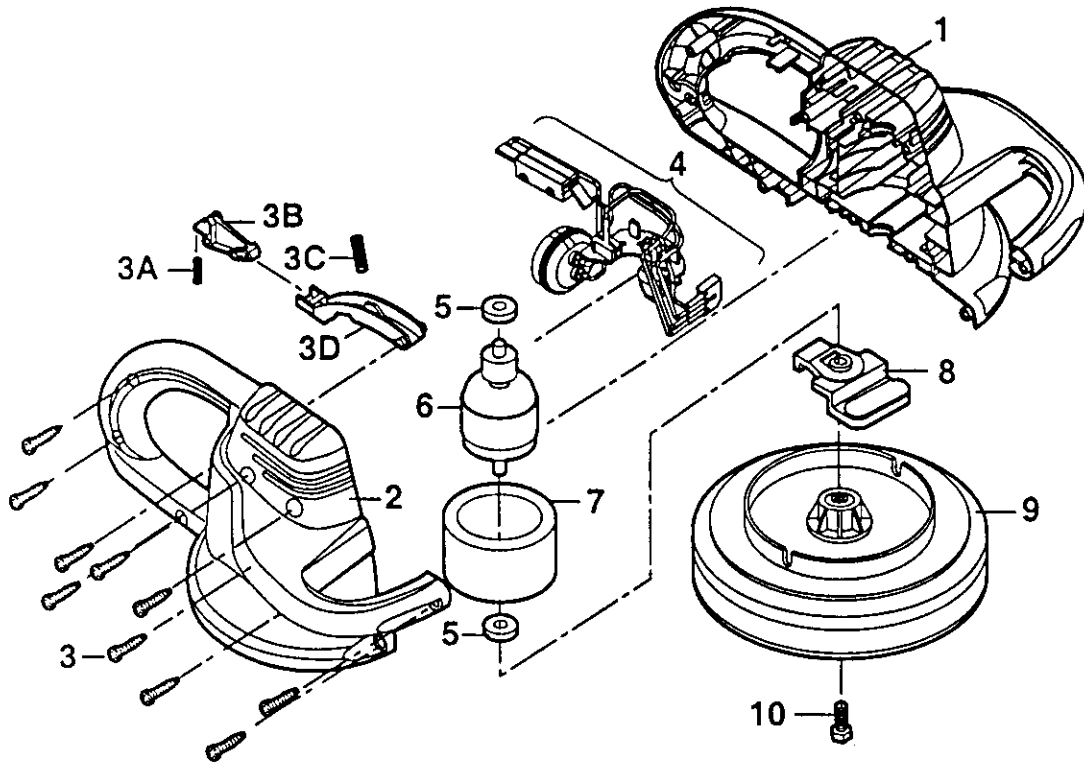

KEY NO.	PART NO.	DESCRIPTION	QTY.
1	41P26042	Support Housing	1
2	41P26224	Cover Housing	1
3	41P18020-1	Screw Kit 3/4" (includes 10 screws)	1
3A	41P18605	Small Spring, Lock Button	1
3B	41P14021	Lock Button	1
3C	41P18606	Large Spring, Switch Actuator	1
3D	41P14020	Switch Actuator	1
4	41P2503901	Wire Harness Sub Assembly	1
5	41P18501	Bearing	2
6	41P21518	Armature Assembly	1
7	41P23204	Magnet, Yoke Assembly	1
8	41P17000	Counterweight	1
9	41P27014	Pad/Pad Holder Assembly (pre-assembled)	1
10	41P18024	Left-Handed Threaded Bolt	1
	41P58063	Owner's Manual	1

**For in-home major brand repair service:**

Call 24 hours a day, 7 days a week

**1-800-4-MY-HOME<sup>SM</sup>** (1-800-469-4663)

**Para pedir servicio de reparación a domicilio – 1-800-676-5811**

**For the repair or replacement parts you need:**

Call 6 a.m. – 11 p.m. CST, 7 days a week

**PartsDirect<sup>SM</sup>**

**1-800-366-PART** (1-800-366-7278)

[www.sears.com/partsdirect](http://www.sears.com/partsdirect)

**Para ordenar piezas con entrega a domicilio – 1-800-659-7084**

**For the location of a Sears Service Center in your area:**

Call 24 hours a day, 7 days a week

**1-800-488-1222**

**To purchase or inquire about a Sears Maintenance Agreement:**

Call 7 a.m. – 5 p.m. CST, Monday – Saturday

**1-800-827-6655**



## Free Manuals Download Website

<http://myh66.com>

<http://usermanuals.us>

<http://www.somanuals.com>

<http://www.4manuals.cc>

<http://www.manual-lib.com>

<http://www.404manual.com>

<http://www.luxmanual.com>

<http://aubethermostatmanual.com>

Golf course search by state

<http://golfingnear.com>

Email search by domain

<http://emailbydomain.com>

Auto manuals search

<http://auto.somanuals.com>

TV manuals search

<http://tv.somanuals.com>