

# CHAMBERLAIN®

## Belt Drive Battery Backup Garage Door Opener

### Models

- HD920EV
- HD930EV
- LW5000EV
- WD962KEV
- WD962KPEV
- WD962MLEV
- 349544

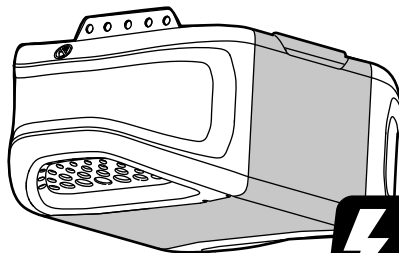

WORKS EVEN WHEN THE POWER IS OUT.

- Please read this manual and the enclosed safety materials carefully!
- Fasten the manual near the garage door after installation.
- The door **WILL NOT CLOSE** unless the Protector System® is connected and properly aligned.
- Periodic checks of the garage door opener are required to ensure safe operation.
- The model number label is located on the left side panel of your garage door opener.
- This garage door opener is compatible with MyQ® and Security+ 2.0™ accessories.
- **DO NOT enable the Timer-to-Close feature if you are installing the garage door opener on a one-piece door. The Timer-to-Close is to be used ONLY with sectional doors.**

FOR RESIDENTIAL USE ONLY

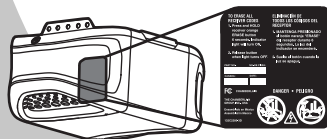

Write down the following information for future reference:

Model Number:

Serial Number:

Date of Purchase:

## CONTENTS

Preparation . . . . .	1-4
Assembly . . . . .	5-9
Installation . . . . .	10-19
Install the Door Control . . . . .	20-21
Install the Protector System® . . . . .	22-25
Power . . . . .	26-28
Adjustments . . . . .	29-31
Battery Backup . . . . .	32-33
Operation . . . . .	34
Features . . . . .	35
Door Control . . . . .	36-38
Remote Control . . . . .	39-40
To Erase the Memory . . . . .	40
To Open the Door Manually . . . . .	40
Maintenance . . . . .	41
Troubleshooting . . . . .	42-43
Accessories . . . . .	44
Warranty . . . . .	45
Repair Parts . . . . .	46-47



www.chamberlain.com

The Chamberlain Group, Inc.  
845 Larch Avenue  
Elmhurst, Illinois 60126-1196

# Preparation

## Safety Symbol and Signal Word Review

This garage door opener has been designed and tested to offer safe service provided it is installed, operated, maintained and tested in strict accordance with the instructions and warnings contained in this manual.

When you see these Safety Symbols and Signal Words on the following pages, they will alert you to the possibility of **serious injury or death** if you do not comply with the warnings that accompany them. The hazard may come from something mechanical or from electric shock. Read the warnings carefully.

### **WARNING**

**Mechanical**

### **WARNING**

**Electrical**

When you see this Signal Word on the following pages, it will alert you to the possibility of damage to your garage door and/or the garage door opener if you do not comply with the cautionary statements that accompany it. Read them carefully.

### **CAUTION**

## Check the Door

### **WARNING**

To prevent possible **SERIOUS INJURY** or **DEATH**:

- ALWAYS call a trained door systems technician if garage door binds, sticks, or is out of balance. An unbalanced garage door may NOT reverse when required.
- NEVER try to loosen, move or adjust garage door, door springs, cables, pulleys, brackets or their hardware, ALL of which are under **EXTREME** tension.
- Disable ALL locks and remove ALL ropes connected to garage door **BEFORE** installation and operating garage door opener to avoid entanglement.

### **CAUTION**

To prevent damage to garage door and opener:

- ALWAYS disable locks **BEFORE** installing and operating the opener.
- ONLY operate garage door opener at 120 V, 60 Hz to avoid malfunction and damage.

1. Disable locks and remove any ropes connected to the garage door.
2. Lift the door halfway up. Release the door. If balanced, it should stay in place, supported entirely by its springs.
3. Raise and lower the door to check for binding or sticking. If your door binds, sticks, or is out of balance, call a trained door systems technician.
4. Check the seal on the bottom of the door. Any gap between the floor and the bottom of the door must not exceed 1/4 inch (6 mm). Otherwise, the safety reversal system may not work properly.
5. The opener should be installed above the center of the door. If there is a torsion spring or center bearing plate in the way of the header bracket, it may be installed within 4 feet (1.2 m) to the left or right of the door center. See page 12.

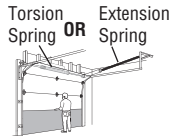

# Preparation

## Additional Items You May Need:

Survey your garage area to see if you will need any of the following items:

- **(2) 2X4 PIECES OF WOOD**  
May be used to fasten the header bracket to the structural supports. Also used to position the garage door opener during installation and for testing the safety reversing sensors.
- **SUPPORT BRACKET AND FASTENING HARDWARE**  
Must be used if you have a finished ceiling in your garage.
- **EXTENSION BRACKETS (MODEL 41A5281) OR WOOD BLOCKS**  
Depending upon garage construction, extension brackets or wood blocks may be needed to install the safety reversing sensor.
- **FASTENING HARDWARE**  
Alternate floor mounting of the safety reversing sensor will require hardware not provided.
- **OUTSIDE QUICK RELEASE (MODEL 7702CB)**  
Required for a garage with NO access door.
- **DOOR REINFORCEMENT**  
Required if you have a lightweight steel, aluminum, fiberglass or glass panel door.
- **RAIL EXTENSION KIT**  
Required if your garage door is more than 7 feet (2.13 m) high.

## Tools Needed

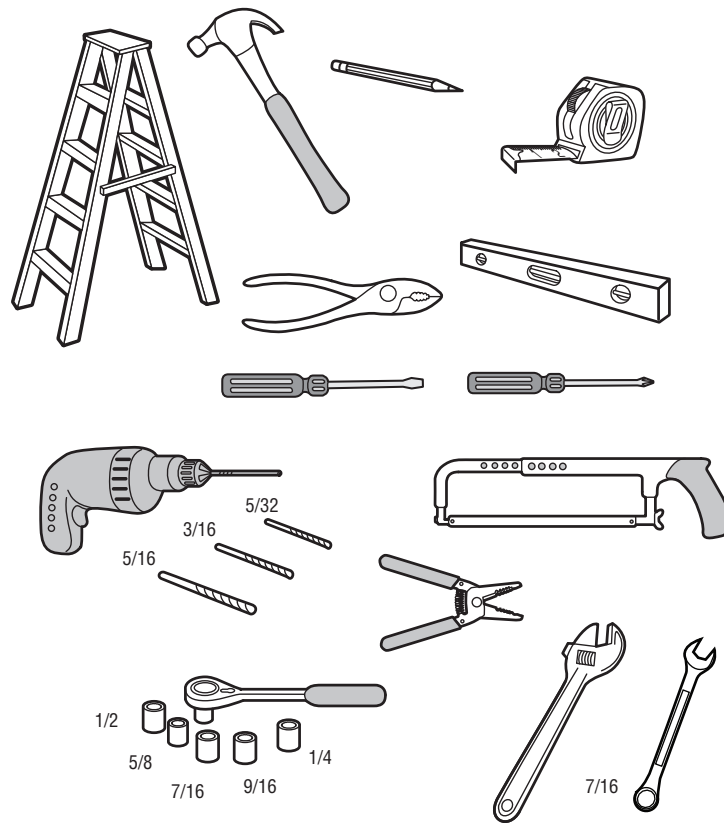

# Preparation

## Carton Inventory

Your garage door opener is packaged in one carton which contains the motor unit and all parts illustrated below. Accessories vary depending on the garage door opener model purchased. Depending on your model, other accessories may be included with your garage door opener. Instructions for these accessories will be attached to the accessory and are not included in this manual. If anything is missing, carefully check the packing material. Hardware for assembly and installation is shown on the next page. Save the carton and packing material until the installation and adjustment is complete. The images throughout this manual are for reference only and your product may look different.

- A. Header bracket
  - B. Pulley
  - C. Door bracket
  - D. Curved door arm
  - E. Straight door arm  
(Packaged inside front rail section)
  - F. Trolley
- NOTE:** Be sure to assemble the trolley before sliding onto rail.

- G. Emergency release rope and handle
- H. Rail (1 front and 4 center sections)
- I. Hanging brackets (2)  
(Packaged inside the front rail section)
- J. Garage door opener (motor unit)
- K. Sprocket cover and screws
- L. "U" bracket
- M. Belt
- N. Door control (Motion-Detecting Control Panel or Smart Control Panel®)
- O. Remote control
- P. **The Protector System®**

Safety reversing sensors with 2 conductor white and white/black wire attached: Sending Sensor (1), Receiving Sensor (1), and Safety Sensor Brackets (2)

## NOT SHOWN

White and red/white wire  
Owner's manual

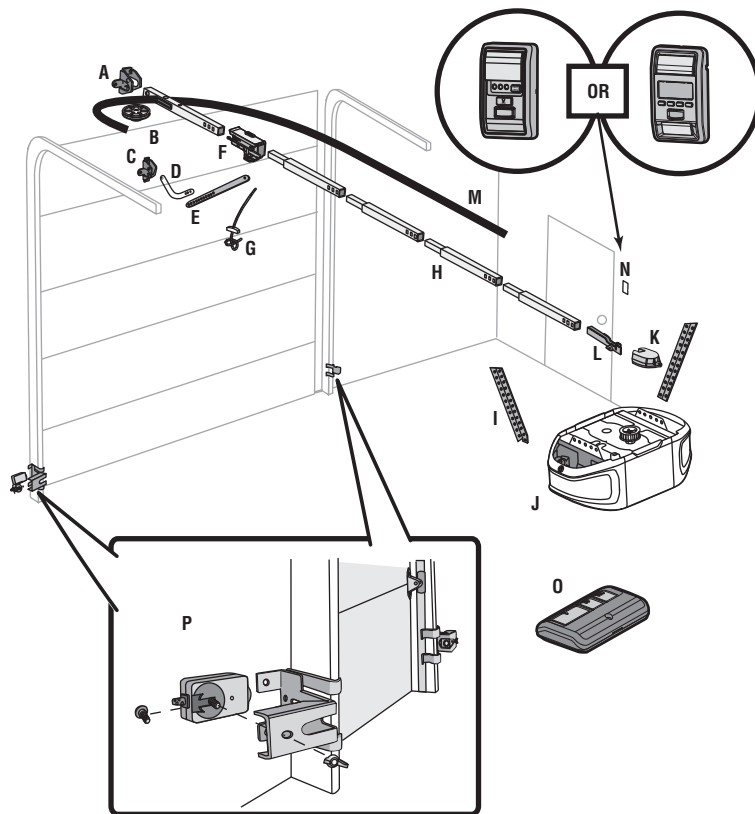

# Preparation

## Hardware Inventory

### ASSEMBLY HARDWARE

Bolt  
1/4"-20x1-3/4"

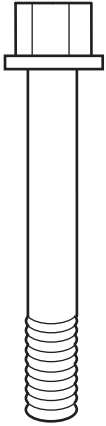

Lock Nut  
1/4"-20

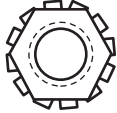

Lock Washer 3/8"



Nut 3/8"



Bolt

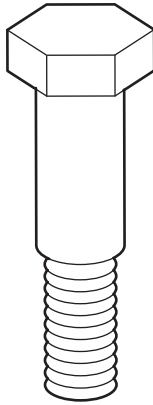

Hex Screw  
#8x3/8" (3)  
(packed with the  
sprocket cover)



### INSTALLATION HARDWARE

Self-Threading Screw  
1/4"-14x5/8" (2)

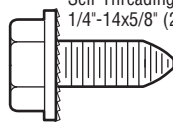

Lag Screw 5/16"-9x1-5/8" (4)

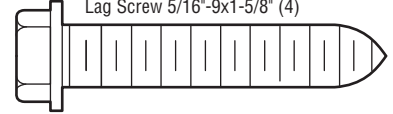

Clevis Pin 5/16"x1-1/2"

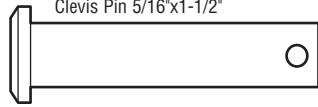

Clevis Pin 5/16"x1-1/4"

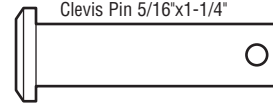

Clevis Pin 5/16"x1"

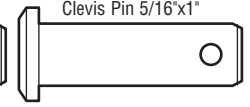

Carriage Bolt  
1/4"-20x1/2" (2)

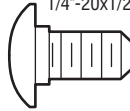

Wing Nut 1/4"-20 (2)



Hex Bolt 5/16"-18x7/8" (4)



Nut  
5/16"-18 (6)



Lock Washer  
5/16"-18 (5)



Ring Fastener (3)



### DOOR CONTROL HARDWARE

Screw 6-32x1" (2)

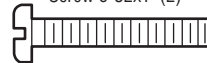

Drywall Anchors (2)

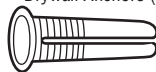

Screw 6ABx1" (2)

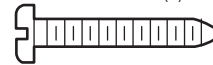

Insulated  
Staples  
(Not Shown)

# Assembly

## STEP 1 Assemble the rail and trolley

### CAUTION

To prevent INJURY from pinching, keep hands and fingers away from the joints while assembling the rail.

To avoid installation difficulties, do not run the garage door opener until instructed to do so.

The front rail has a cut out "window" at the door end (see illustration). The hole above this window is larger on the top of the rail than on the bottom. A smaller hole 3-1/2" (8.9 cm) away is close to the rail edge. Rotate the back rail so it has a similar hole close to the opposite edge, about 4-3/4" (12 cm) from the far end.

1. Remove the straight door arm and hanging bracket packaged inside the front rail and set aside for Installation Step 5 and 9. **NOTE:** To prevent INJURY while unpacking the rail carefully remove the straight door arm stored within the rail section.
2. Align the rail sections on a flat surface as shown and slide the tapered ends into the larger ones. Tabs along the side will lock into place.
3. Place the motor unit on packing material to protect the cover, and rest the back end of the rail on top. For convenience, put a support under the front end of the rail.
4. As a temporary stop, insert a screwdriver into the hole 10" (25 cm) from the front end of the rail, as shown.
5. Check to be sure there are 4 plastic wear pads inside the inner trolley. If they became loose during shipping, check all packing material. Snap them back into position as shown.
6. Slide the trolley assembly toward the screwdriver as shown.
7. Slide the rail onto the "U" bracket, until it reaches all the stops on the top and sides of the "U" bracket.

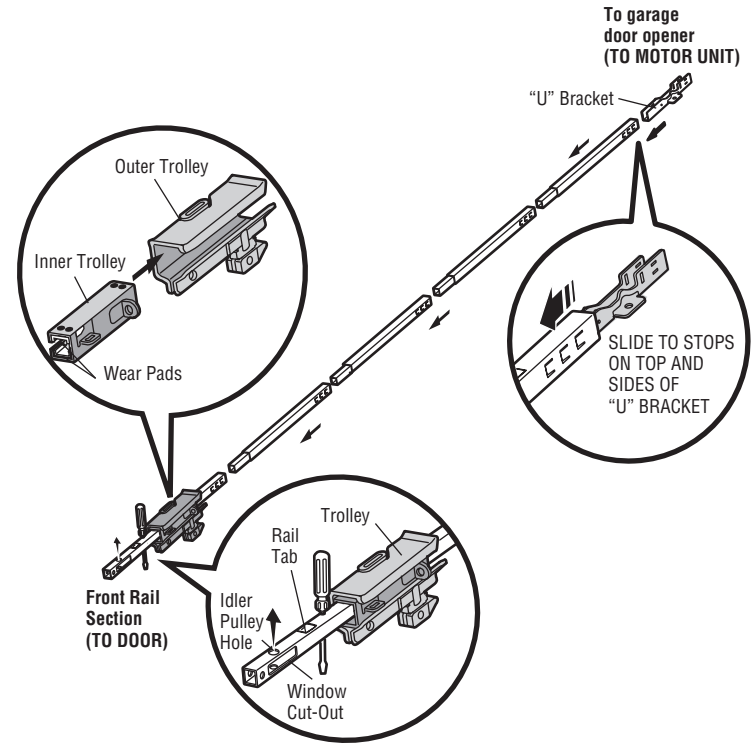

# Assembly

## STEP 2 Fasten the rail to the motor unit

### CAUTION

To avoid SERIOUS damage to garage door opener, use ONLY those bolts/fasteners mounted in the top of the opener.

1. Insert a 1/4"-20x1-3/4" bolt into the cover protection bolt hole on the back end of the rail as shown. Tighten securely with a 1/4"-20 lock nut. Do NOT overtighten.
2. Remove the two bolts from the top of the motor unit.
3. Use the carton to support the front end of the rail.
4. Place the "U" bracket, flat side down onto the motor unit and align the bracket holes with the bolt holes.
5. Fasten the "U" bracket with the previously removed bolts; DO NOT use any power tools. The use of power tools may permanently damage the garage door opener.

#### HARDWARE

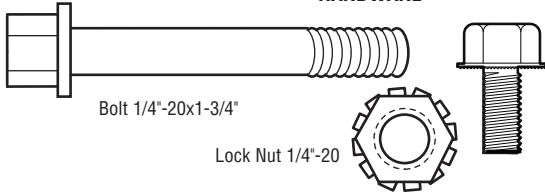

Bolts  
(Mounted in the  
garage door opener)

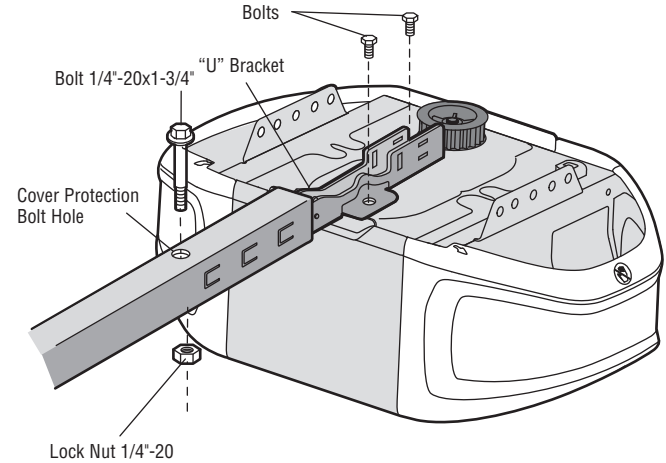

# Assembly

## STEP 3 Install the idler pulley

1. Lay the belt beside the rail, as shown. Grasp the end with the hooked trolley connector and pass approximately 12" (30 cm) of belt through the window. Keep the ribbed side toward the rail, and allow it to hang until Assembly Step 4.
2. Remove the tape from the idler pulley. The inside center should be pre-greased. If dry, regrease to ensure proper operation.
3. Place the idler pulley into the window as shown.
4. Insert the idler bolt from the top through the rail and pulley. Tighten with a 3/8" lock washer and nut underneath the rail until the lock washer is compressed.
5. Rotate the pulley to be sure it spins freely.
6. Locate the rail tab. The rail tab is between the idler bolt and the trolley in the front rail section. Use a flat head screwdriver and lift the rail tab until the tab is vertical (90°).

### HARDWARE

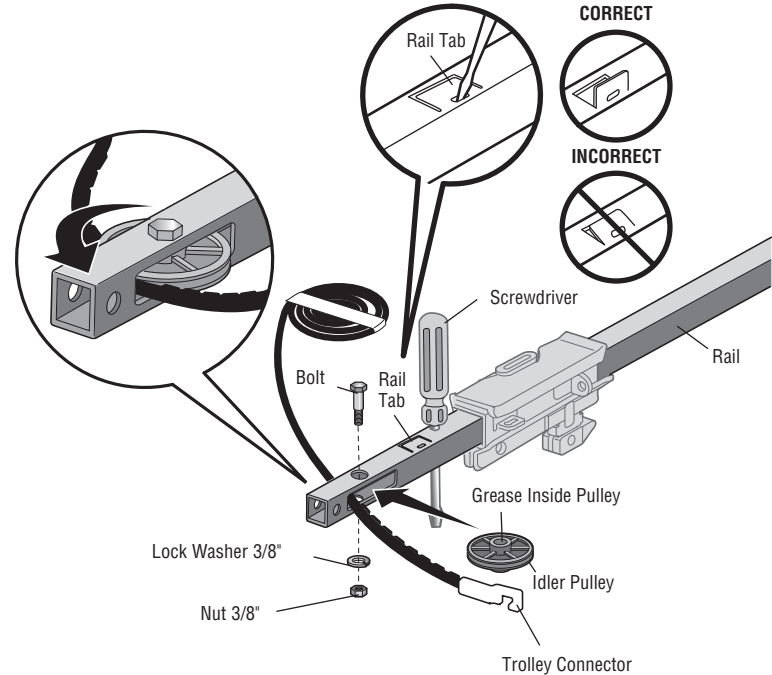
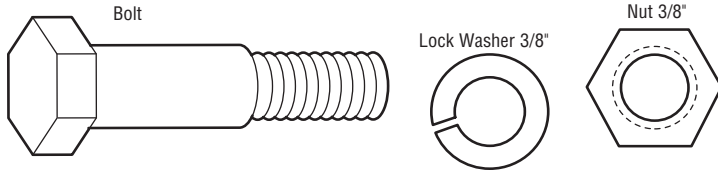



# Assembly

## STEP 4 Install the belt

1. Pull the belt around the idler pulley and toward the trolley. The ribbed side must contact the pulley.
2. Hook the trolley connector into the retaining slot on the trolley. **(a)**
3. With the trolley against the screwdriver, dispense the remainder of the belt along the rail toward the motor unit around the sprocket. The sprocket teeth must engage the belt. **(b)**
4. Thread the inner nut and lock washer onto the trolley thread shaft **(c)**. Check to make sure the belt is not twisted.
5. Insert the trolley threaded shaft through the hole in the trolley. Be sure the belt is not twisted. **(c)**
6. Loosely thread the outer nut onto the trolley threaded shaft.
7. Remove the screwdriver.

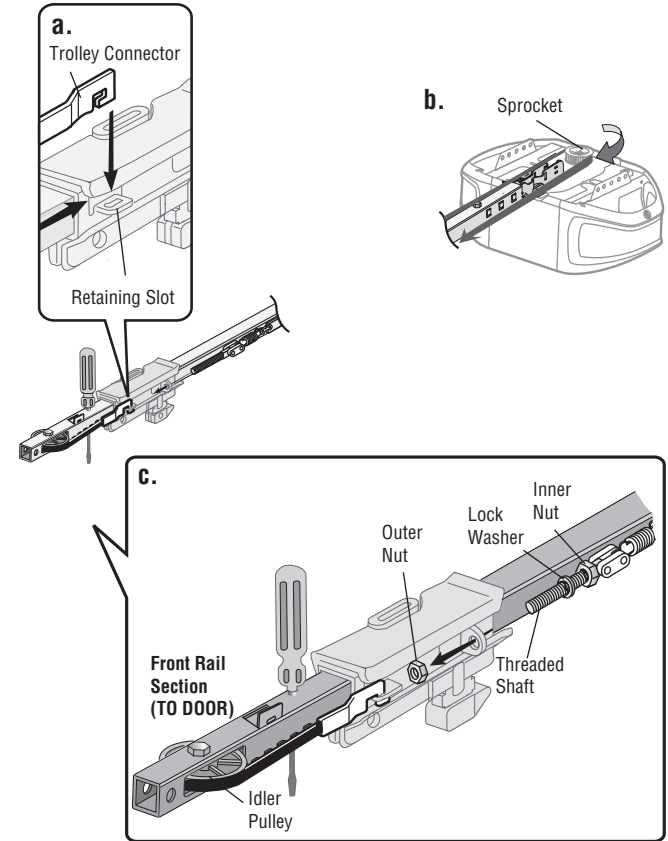

# Assembly

## STEP 5 Tighten the belt and install the sprocket cover

### **WARNING**

To avoid possible **SERIOUS INJURY** to finger from moving garage door opener:

- ALWAYS keep hand clear of sprocket while operating opener.
- Securely attach sprocket cover **BEFORE** operating.

1. Spin the inner nut and lock washer down the trolley threaded shaft, away from the trolley
2. To tighten the belt, turn outer nut in the direction shown until the line on the spring retainer plate is visible. Be sure the belt is not twisted, and the ribbed side faces the rail.
3. Tighten the inner nut to secure the adjustment. This sets the spring to optimum belt tension.
4. Position the sprocket cover over the sprocket as shown and fasten to the mounting plate with 8x3/8" hex screws provided.

**You have now finished assembling your garage door opener. Please read the following warnings before proceeding to the installation section.**

### HARDWARE

Hex Screw #8x3/8"  
(Packed with the sprocket cover)

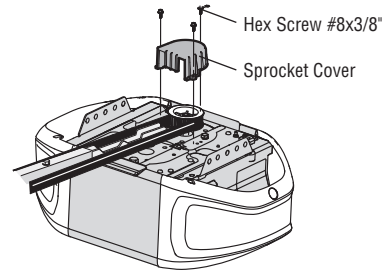
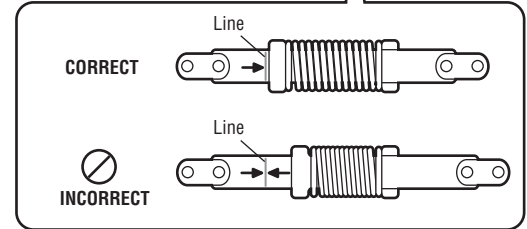
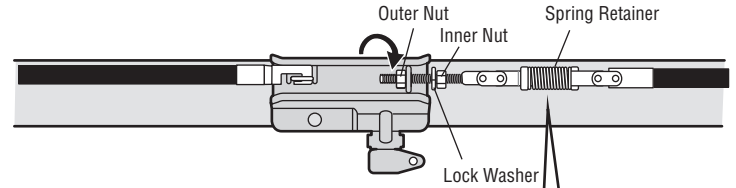

## IMPORTANT INSTALLATION INSTRUCTIONS



### To reduce the risk of SEVERE INJURY or DEATH:

1. READ AND FOLLOW ALL INSTALLATION WARNINGS AND INSTRUCTIONS.
2. Install garage door opener ONLY on properly balanced and lubricated garage door. An improperly balanced door may NOT reverse when required and could result in SEVERE INJURY or DEATH.
3. ALL repairs to cables, spring assemblies and other hardware MUST be made by a trained door systems technician BEFORE installing opener.
4. Disable ALL locks and remove ALL ropes connected to garage door BEFORE installing opener to avoid entanglement.
5. Install garage door opener 7 feet (2.13 m) or more above floor.
6. Mount the emergency release within reach, but at least 6 feet (1.83 m) above the floor and avoiding contact with vehicles to avoid accidental release.
7. NEVER connect garage door opener to power source until instructed to do so.
8. NEVER wear watches, rings or loose clothing while installing or servicing opener. They could be caught in garage door or opener mechanisms.
9. Install wall-mounted garage door control:
  - within sight of the garage door.
  - out of reach of children at minimum height of 5 feet (1.5 m).
  - away from ALL moving parts of the door.
10. Place entrapment warning label on wall next to garage door control.
11. Place manual release/safety reverse test label in plain view on inside of garage door.
12. Upon completion of installation, test safety reversal system. Door MUST reverse on contact with a 1-1/2" (3.8 cm) high object (or a 2x4 laid flat) on the floor.
13. To avoid SERIOUS PERSONAL INJURY or DEATH from electrocution, disconnect ALL electric and battery power BEFORE performing any service or maintenance.
14. DO NOT enable the Timer-to-Close functionality if operating either one-piece or swinging garage doors. To be enabled ONLY when operating a sectional door.

# Installation

## STEP 1 Determine the header bracket location

### **WARNING**

To prevent possible **SERIOUS INJURY** or **DEATH**:

- Header bracket **MUST** be **RIGIDLY** fastened to structural support on header wall or ceiling, otherwise garage door might **NOT** reverse when required. **DO NOT** install header bracket over drywall.
- Concrete anchors **MUST** be used if mounting header bracket or 2x4 into masonry.
- **NEVER** try to loosen, move or adjust garage door, springs, cables, pulleys, brackets, or their hardware, **ALL** of which are under **EXTREME** tension.
- **ALWAYS** call a trained door systems technician if garage door binds, sticks, or is out of balance. An unbalanced garage door might **NOT** reverse when required.

Installation procedures vary according to garage door types. Follow the instructions which apply to your door.

1. Close the door and mark the inside vertical centerline of the garage door.
2. Extend the line onto the header wall above the door.

**You can fasten the header bracket within 4 feet (1.22 m) of the left or right of the door center only if a torsion spring or center bearing plate is in the way; or you can attach it to the ceiling when clearance is minimal. (It may be mounted on the wall upside down if necessary, to gain approximately 1/2" (1 cm).**

If you need to install the header bracket on a 2x4 (on wall or ceiling), use lag screws (not provided) to securely fasten the 2x4 to structural supports.

3. Open your door to the highest point of travel as shown. Draw an intersecting horizontal line on the header wall 2" (5 cm) above the high point:
  - 2" (5 cm) above the high point for sectional door and one-piece door with track.
  - 8" (20 cm) above the high point for one-piece door without track.

This height will provide travel clearance for the top edge of the door. **NOTE:** If the total number of inches exceeds the height available in your garage, use the maximum height possible, or refer to page 12 for ceiling installation.

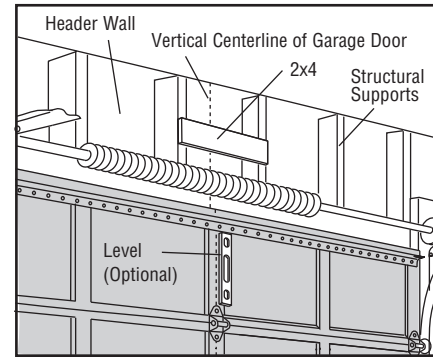

### OPTIONAL CEILING MOUNT FOR HEADER BRACKET

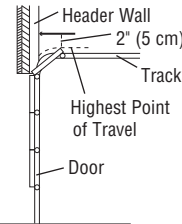
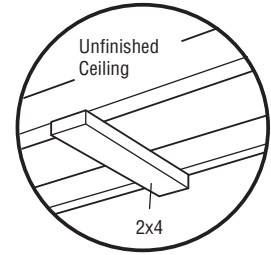

Sectional door with curved track

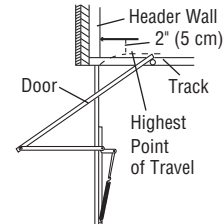

One-piece door with horizontal track

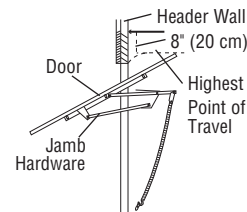

One-piece door without track:  
jamb hardware

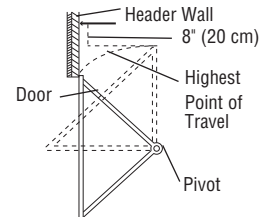

One-piece door without track:  
pivot hardware

# Installation

## STEP 2 Install the header bracket

You can attach the header bracket either to the wall above the garage door, or to the ceiling. Follow the instructions which will work best for your particular requirements. **Do not install the header bracket over drywall. If installing into masonry, use concrete anchors (not provided).**

### HARDWARE

Lag Screw 5/16"-9x1-5/8"

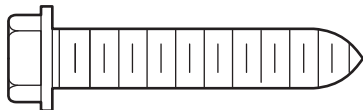

## OPTION A WALL INSTALLATION

1. Center the bracket on the vertical centerline with the bottom edge of the bracket on the horizontal line as shown.
2. Mark the vertical set of bracket holes. Drill 3/16" pilot holes and fasten the bracket securely to a structural support with the hardware provided.

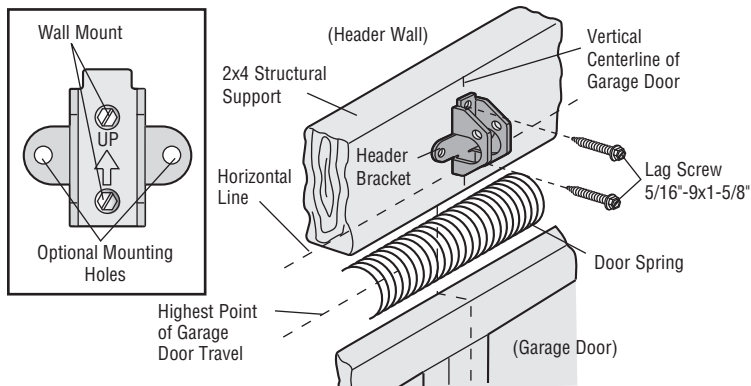

## OPTION B CEILING INSTALLATION

1. Extend the vertical centerline onto the ceiling as shown.
2. Center the bracket on the vertical mark, no more than 6" (15 cm) from the wall. Make sure the arrow is pointing away from the wall. The bracket can be mounted flush against the ceiling when clearance is minimal.
3. Mark the side holes. Drill 3/16" pilot holes and fasten bracket securely to a structural support with the hardware provided.

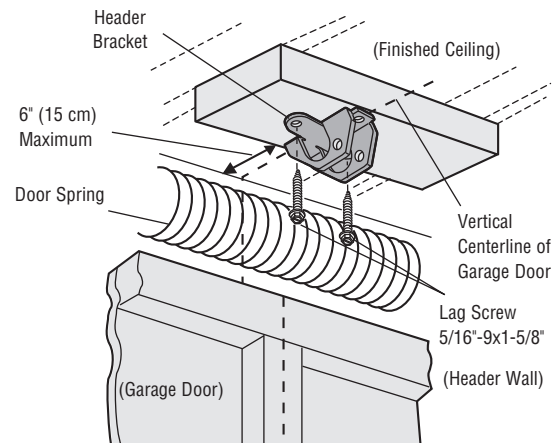
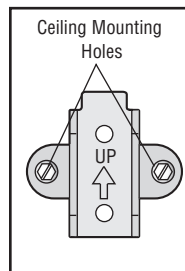

# Installation

## STEP 3 Attach the rail to the header bracket

1. Align the rail with the header bracket. Insert the clevis pin through the holes in the header bracket and rail. Secure with the ring fastener.

**NOTE:** Use the packing material as a protective base for the garage door opener.

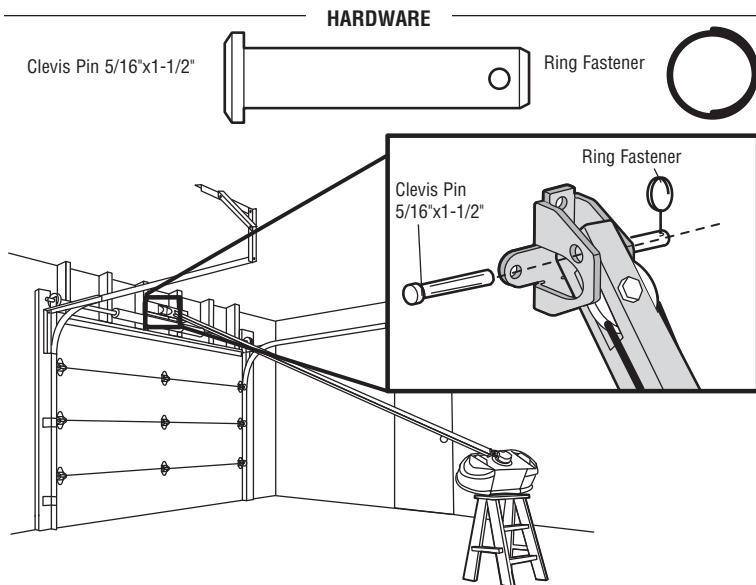

## STEP 4 Position the garage door opener

### CAUTION

To prevent damage to garage door, rest garage door opener rail on 2x4 placed on top section of door.

1. Remove the packing material and lift the garage door opener onto a ladder.
2. Fully open the door and place a 2x4 (laid flat) under the rail. For one-piece doors without tracks, lay the 2x4 on it's side.

**NOTE:** A 2x4 is ideal for setting the distance between the rail and the door. If the ladder is not tall enough you will need help at this point. If the door hits the trolley when it is raised, pull the trolley release arm down to disconnect the inner and outer trolley. Slide the outer trolley toward the garage door opener. The trolley can remain disconnected until instructed.

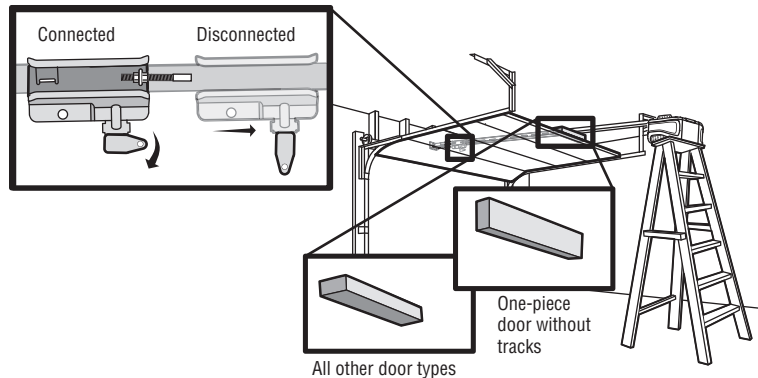

# Installation

## STEP 5 Hang the garage door opener

### **WARNING**

To avoid possible **SERIOUS INJURY** from a falling garage door opener, fasten it **SECURELY** to structural supports of the garage. Concrete anchors **MUST** be used if installing **ANY** brackets into masonry.

Hanging the garage door opener will vary depending on your garage. Below are three example installations. Your installation may be different. For **ALL** installations the garage door opener **MUST** be connected to structural supports. The instructions illustrate one of the examples below.

Finished Ceiling

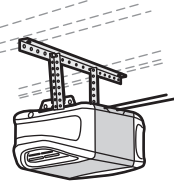
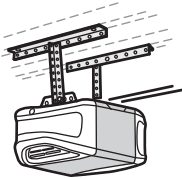

Unfinished Ceiling

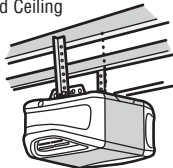

### HARDWARE

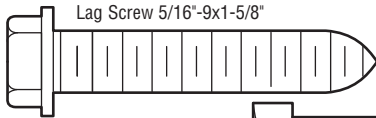

Lag Screw 5/16"-9x1-5/8"

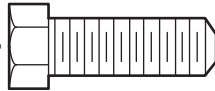

Hex Bolt 5/16"- 18x7/8"



Lock Washer 5/16"-18



Nut 5/16"-18

1. On finished ceilings, use the lag screws to attach a support bracket (not provided) to the structural supports before installing the garage door opener.
2. Make sure the garage door opener is aligned with the header bracket. Measure the distance from each side of the garage door opener to the support bracket.
3. Cut both pieces of the hanging bracket to required lengths.
4. Attach the end of each hanging bracket to the support bracket with appropriate hardware (not provided).
5. Attach the garage door opener to the hanging brackets with the hex bolts, lock washers, and nuts.
6. Remove the 2x4 and manually close the door. If the door hits the rail, raise the header bracket.

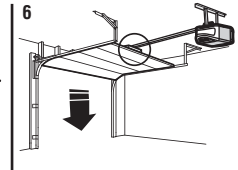
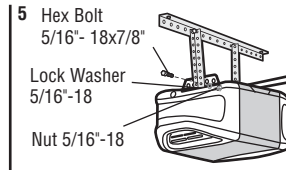
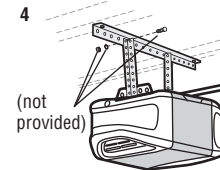
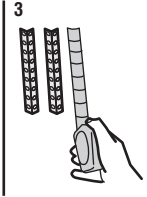
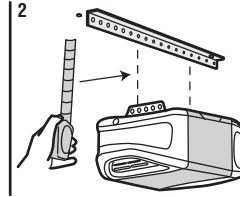
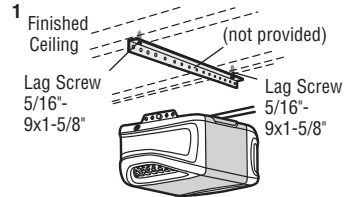

# Installation

## STEP 6 Install the light bulbs

### CAUTION

To prevent possible OVERHEATING of the end panel or light socket:

- Use ONLY A19 incandescent (100W maximum) or compact fluorescent (26W maximum) light bulbs.
- DO NOT use incandescent bulbs larger than 100W.
- DO NOT use compact fluorescent light bulbs larger than 26W (100W equivalent).
- DO NOT use halogen bulbs.
- DO NOT use short neck or specialty light bulbs.

1. Pull on the top sides of the light lens and rotate the light lens down.
2. Insert an A19 incandescent (100W maximum) or compact fluorescent (26W, 100W equivalent) light bulb into the light socket.
3. Rotate the lens up to close.

**NOTE:** Do not use halogen, short neck, or specialty light bulbs as these may overheat the end panel or light socket. Do not use LED bulbs as they may reduce the range or performance of your remote controls.

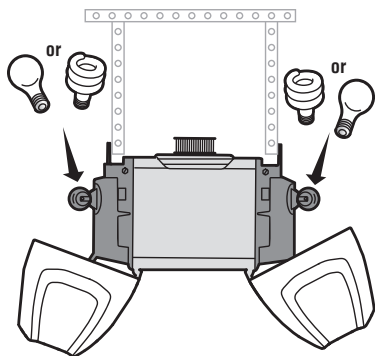

## STEP 7 Attach the emergency release rope and handle

### ! WARNING

To prevent possible SERIOUS INJURY or DEATH from a falling garage door:

- If possible, use emergency release handle to disengage trolley ONLY when garage door is CLOSED. Weak or broken springs or unbalanced door could result in an open door falling rapidly and/or unexpectedly.
- NEVER use emergency release handle unless garage doorway is clear of persons and obstructions.
- NEVER use handle to pull door open or closed. If rope knot becomes untied, you could fall.

1. Insert one end of the emergency release rope through the handle. Make sure that "NOTICE" is right side up. Tie a knot at least 1 inch (2.5 cm) from the end of the emergency release rope.
2. Insert the other end of the emergency release rope through the hole in the trolley release arm. Mount the emergency release within reach, but at least 6 feet (1.83 m) above floor, avoiding contact with vehicles to prevent accidental release and secure with a knot.

**NOTE:** If it is necessary to cut the emergency release rope, seal the cut end with a match or lighter to prevent unraveling. Ensure the emergency release rope and handle are above the top of all vehicles to avoid entanglement.

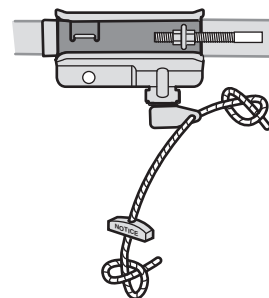



# Installation

## STEP 8 Install the door bracket

### CAUTION

Fiberglass, aluminum or lightweight steel garage doors **WILL REQUIRE** reinforcement BEFORE installation of door bracket. Contact your door manufacturer for reinforcement kit.

Figure 1 shows one piece of angle iron as the horizontal brace. For the vertical brace, 2 pieces of angle iron are used to create a U-shaped support. The best solution is to check with your garage door manufacturer for an opener installation door reinforcement kit.

**NOTE:** Many door reinforcement kits provide for direct attachment of the clevis pin and door arm. In this case you will not need the door bracket; proceed to the next step.

A horizontal and vertical reinforcement is needed for lightweight garage doors (fiberglass, aluminum, steel, doors with glass panel, etc.) (not provided).

A horizontal reinforcement brace should be long enough to be secured to two or three vertical supports. A vertical reinforcement brace should cover the height of the top panel.

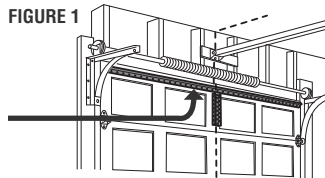
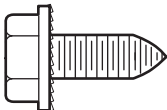

FIGURE 1

#### HARDWARE

Self-Threading Screw  
1/4"-14x5/8"



### OPTION A SECTIONAL DOORS

1. Center the door bracket on the previously marked vertical centerline used for the header bracket installation. Note correct UP placement, as stamped inside the bracket.
2. Position the top edge of the bracket 2"-4" (5-10 cm) below the top edge of the door, OR directly below any structural support across the top of the door.
3. Mark, drill holes and install as follows, depending on your door's construction:

**Metal or light weight doors using a vertical angle iron brace between the door panel support and the door bracket:**

- Drill 3/16" fastening holes. Secure the door bracket using the two self threading screws. (Figure 2)
- Alternately, use two 5/16" bolts, lock washers and nuts (not provided). (Figure 3)

**Metal, insulated or light weight factory reinforced doors:**

- Drill 3/16" fastening holes. Secure the door bracket using the self-threading screws. (Figure 4)

**Wood Doors:**

- Use top and bottom or side to side door bracket holes. Drill 5/16" holes through the door and secure bracket with 5/16"x2" carriage bolts, lock washers and nuts (not provided). (Figure 5)

**NOTE:** The 1/4"-14x5/8" self-threading screws are not intended for use on wood doors.

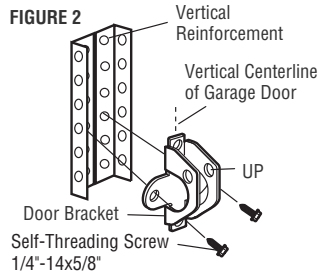

FIGURE 2

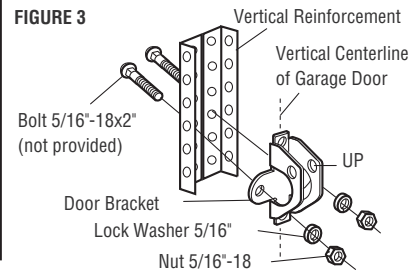

FIGURE 3

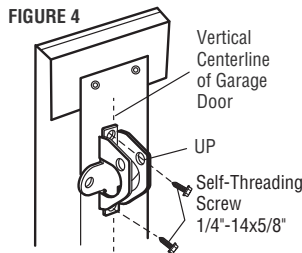

FIGURE 4

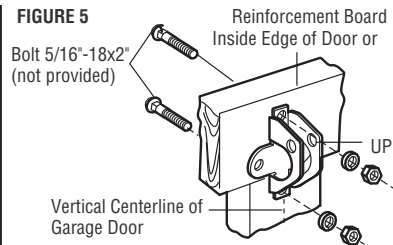

FIGURE 5

# Installation

## STEP 8 Install the door bracket (continued)

### OPTION B ONE-PIECE DOORS

1. Center the door bracket on the top of the door, in line with the header bracket as shown.
2. Mark either the left and right, or the top and bottom holes.

#### Metal Doors:

- Drill 3/16" pilot holes and fasten the bracket with the self-threading screws provided.

#### Wood Doors:

- Drill 5/16" holes and use 5/16"x2" carriage bolts, lock washers and nuts (not provided) or 5/16"x1-1/2" lag screws (not provided) depending on your installation needs.

**NOTE:** The door bracket may be installed on the top edge of the door if required for your installation. (Refer to the dotted line optional placement drawing.)

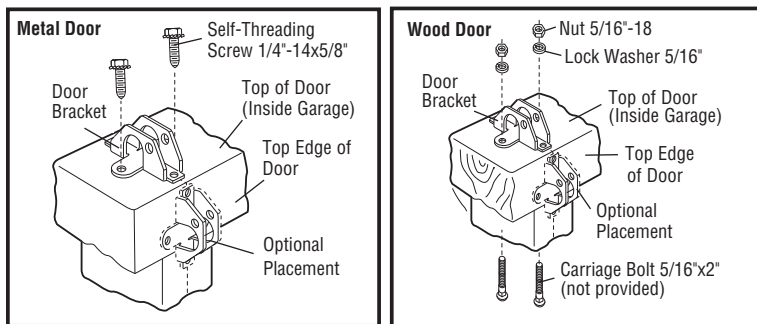
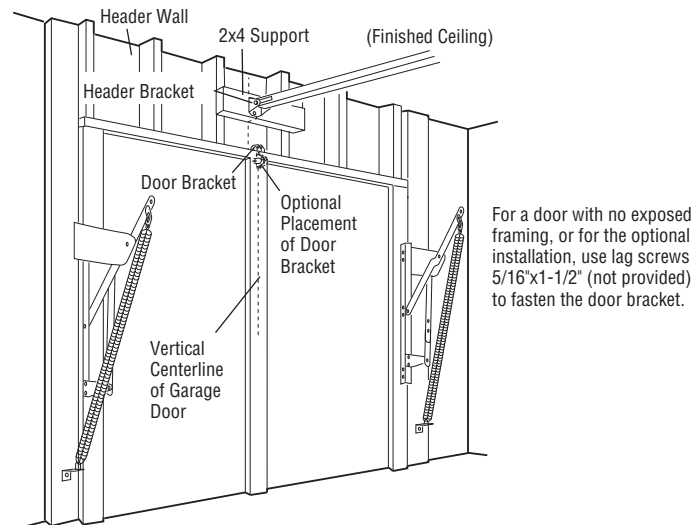

# Installation

## STEP 9 Connect the door arm to the trolley

Installation will vary according to the garage door type. Follow the instructions which apply to your door.

### OPTION A SECTIONAL DOORS

**IMPORTANT:** The groove on the straight door arm **MUST** face away from the curved door arm.

1. Close the door. Disconnect the trolley by pulling the emergency release handle.
2. Attach the straight door arm to the outer trolley using the clevis pin. Secure with the ring fastener.
3. Attach the curved door arm to the door bracket using the clevis pin. Secure with the ring fastener.
4. Bring arm sections together. Find two pairs of holes that line up and join sections. Select holes as far apart as possible to increase door arm rigidity and attach using the bolts, nuts, and lock washers.
5. Pull the emergency release handle toward the garage door opener until the trolley release arm is horizontal. The trolley will re-engage automatically when the garage door opener is activated.

**NOTE:** If the holes in the curved door arm and the straight door arm do not align, reverse the straight door arm, select two holes (as far apart as possible) and attach using bolts, nuts, and lock washers. If the straight door arm is hanging down too far, you may cut 6 inches (15 cm) from the solid end.

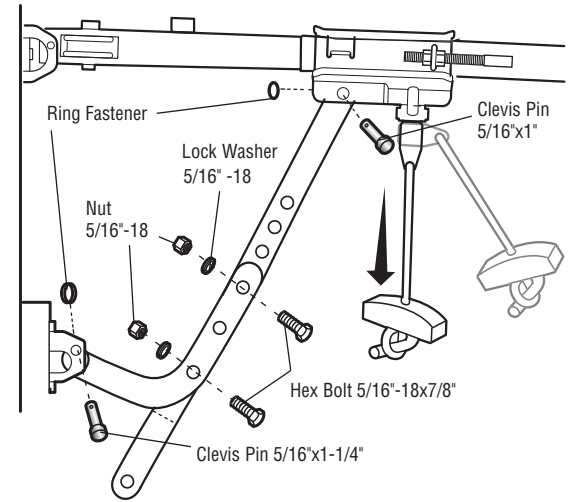
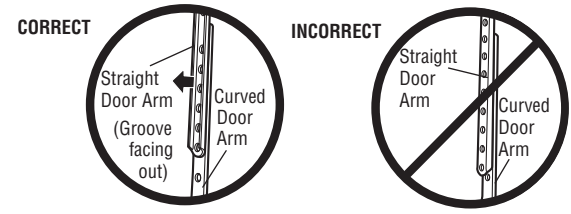

### HARDWARE

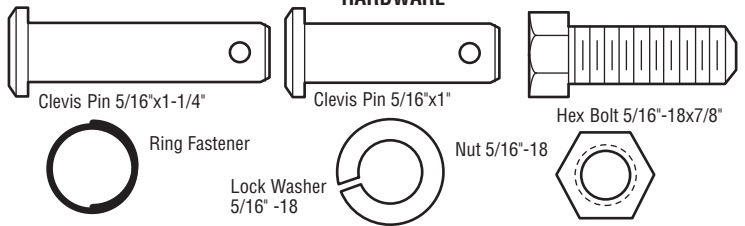

# Installation

## STEP 9 Connect the door arm to the trolley (continued)

### OPTION B ONE-PIECE DOORS

**IMPORTANT:** The groove on the straight door arm **MUST** face away from the curved door arm.

1. Close the door. Disconnect the trolley by pulling the emergency release handle.
2. Fasten the straight door arm and the curved door arm together to the longest possible length (with a 2 or 3 hole overlap) using the bolts, nuts, and lock washers.
3. Attach the straight door arm to the door bracket using the clevis pin. Secure with the ring fastener.
4. Attach the curved door arm to the trolley using the clevis pin. Secure with the ring fastener.
5. Pull the emergency release handle toward the garage door opener until the trolley release arm is horizontal.

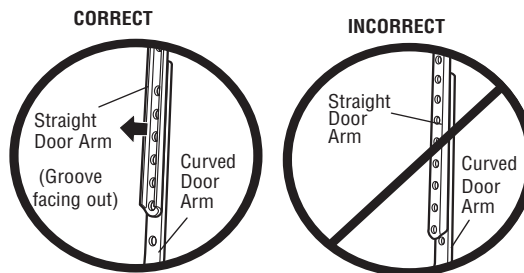
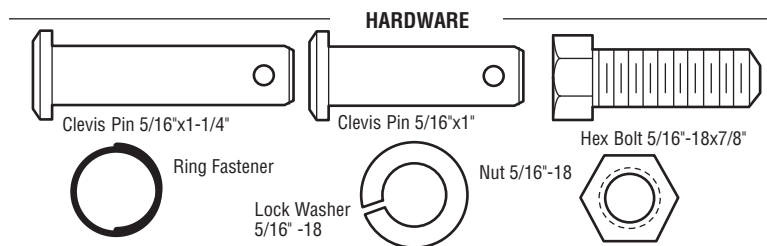

### One-Piece Door without Track

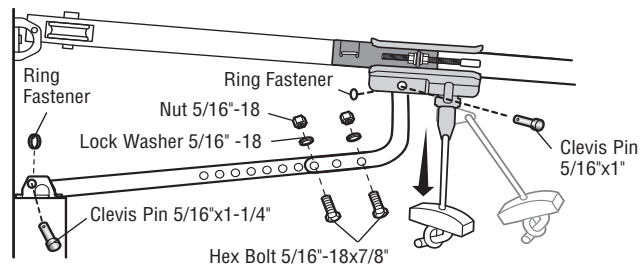

### One-Piece Door with Track

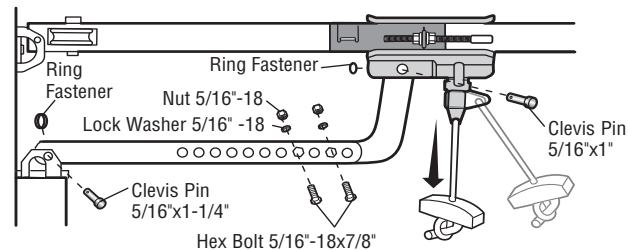

# Installation

## STEP 10 Install the door control

### WARNING

To prevent possible SERIOUS INJURY or DEATH from electrocution:

- Be sure power is NOT connected BEFORE installing door control.
- Connect ONLY to 12 VOLT low voltage wires.

To prevent possible SERIOUS INJURY or DEATH from a closing garage door:

- Install door control within sight of garage door, out of reach of children at a minimum height of 5 feet (1.5 m), and away from ALL moving parts of door.
- NEVER permit children to operate or play with door control push buttons or remote control transmitters.
- Activate door ONLY when it can be seen clearly, is properly adjusted, and there are no obstructions to door travel.
- ALWAYS keep garage door in sight until completely closed. NEVER permit anyone to cross path of closing garage door.

### INTRODUCTION

Compatible with MyQ™ enabled accessories, see page 45. Your garage door opener is compatible with up to 2 MyQ™ door controls. **NOTE:** Older Chamberlain door controls and third party products are not compatible.

Install the door control within sight of the door at a minimum height of 5 feet (1.5 m) where small children cannot reach, and away from the moving parts of the door. For gang box installations it is not necessary to drill holes or install the drywall anchors. Use the existing holes in the gang box.

**NOTE:** Your product may look different than the illustrations.

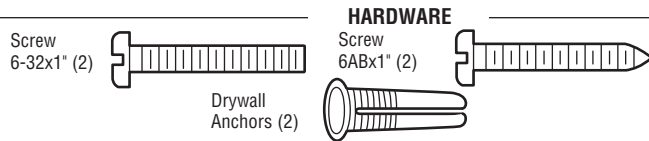

1. Strip 7/16 inch (11 mm) of insulation from one end of the wire and separate the wires.
2. Connect one wire to each of the two screws on the back of the door control. The wires can be connected to either screw. If your garage is pre-wired for the door control choose any two wires to connect, note which wires are used so the correct wires are connected to the garage door opener in a later step.
3. Mark the location of the bottom mounting hole and drill a 5/32 inch (4 mm) hole.
4. Install the bottom screw, allowing 1/8 inch (3 mm) to protrude from the wall.
5. Position the bottom hole of the door control over the screw and slide down into place.
6. Lift the push bar up and mark the top hole.
7. Remove the door control from the wall and drill a 5/32 inch (4 mm) hole for the top screw.
8. Position the bottom hole of the door control over the screw and slide down into place. Attach the top screw.

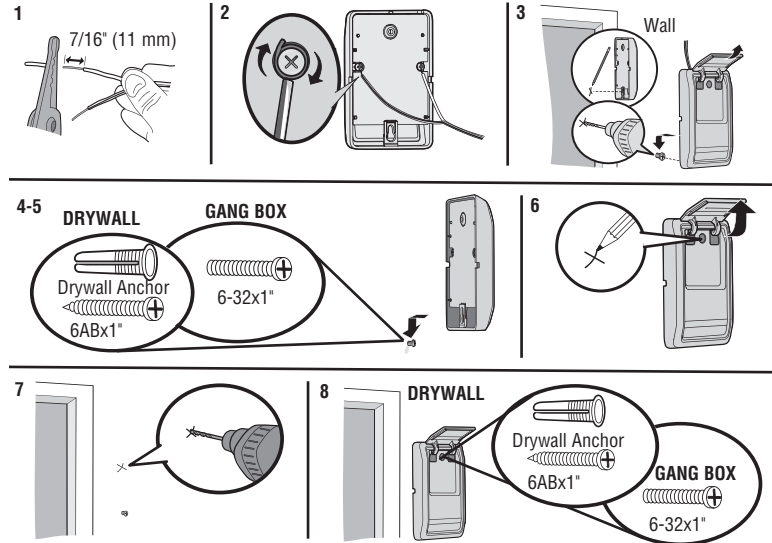

# Installation

## STEP 11 Wire the door control to the garage door opener

### HARDWARE

Insulated Staple  
(Not Shown)

1. Run the white and red/white wire from the door control to the garage door opener. Attach the wire to the wall and ceiling with the staple (not applicable for gang box or pre-wired installations). Do not pierce the wire with the staple as this may cause a short or an open circuit.
2. Strip 7/16 inch (11 mm) of insulation from the end of the wire near the garage door opener.
3. Connect the wire to the red and white terminals on the garage door opener. If your garage is pre-wired make sure you use the same wires that are connected to the door control. To insert or release wires from the terminal, push in the tab with screwdriver tip.

1

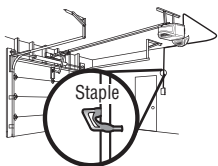

2

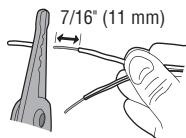

3

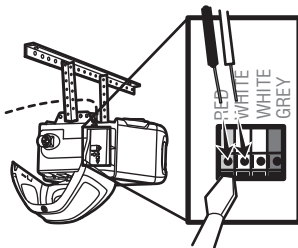

## STEP 12 Attach the warning labels

1. Attach the entrapment warning label on the wall near the door control with tacks or staples.
2. Attach the manual release/safety reverse test label in a visible location on the inside of the garage door.

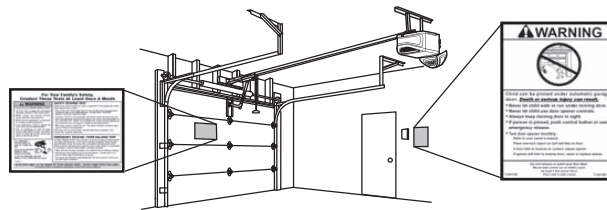

# Installation

## STEP 13 Install the Protector System®

### **WARNING**

Be sure power is NOT connected to the garage door opener BEFORE installing the safety reversing sensor.

To prevent SERIOUS INJURY or DEATH from closing garage door:

- Correctly connect and align the safety reversing sensor. This required safety device MUST NOT be disabled.
- Install the safety reversing sensor so beam is NO HIGHER than 6" (15 cm) above garage floor.

### IMPORTANT INFORMATION ABOUT THE SAFETY REVERSING SENSORS

The safety reversing sensors must be connected and aligned correctly before the garage door opener will move in the down direction.

The sending sensor (with an amber LED) transmits an invisible light beam to the receiving sensor (with a green LED). If an obstruction breaks the light beam while the door is closing, the door will stop and reverse to the full open position, and the garage door opener lights will flash 10 times.

**NOTE:** For energy efficiency the garage door opener will enter sleep mode when the door is fully closed. The sleep mode shuts the garage door opener down until activated. The sleep mode is sequenced with the garage door opener light bulb; as the light bulb turns off the sensor LEDs will turn off and whenever the garage door opener lights turn on the sensor LEDs will light. The garage door opener will not go into the sleep mode until the garage door opener has completed 5 cycles upon power up.

**NOTE:** When installing the safety reversing sensors check the following:

- Sensors are installed inside the garage, one on either side of the door.
- Sensors are facing each other with the lenses aligned and receiving sensor lens does not receive direct sunlight.
- Sensors are no more than 6 inches (15 cm) above the floor and the light beam is unobstructed.

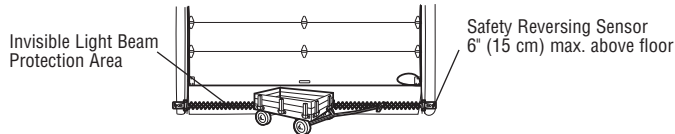

### HARDWARE

Carriage Bolt  
1/4"-20x1/2"

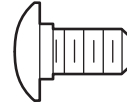

Wing Nut  
1/4"-20



The safety reversing sensors can be attached to the door track, the wall, or the floor. The sensors should be no more than 6 inches (15 cm) above the floor. If the door track will not support the sensor bracket a wall installation is recommended. Choose one of the following installations.

### OPTION A DOOR TRACK INSTALLATION

1. Slide the curved arms of the sensor bracket around the edge of the door track. Snap into place so that the sensor bracket is flush against the track.
2. Slide the carriage bolt into the slot on each sensor.
3. Insert the bolt through the hole in the sensor bracket and attach with the wing nut. The lenses on both sensors should point toward each other. Make sure the lens is not obstructed by the sensor bracket.

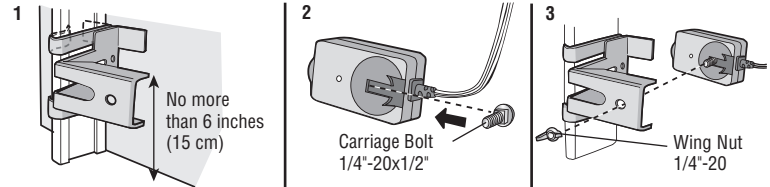

# Installation

## STEP 13 Install the Protector System® (continued)

### OPTION B WALL INSTALLATION

If additional clearance is needed an extension bracket (not provided) or wood blocks can be used. Make sure each bracket has the same amount of clearance so they will align correctly.

1. Position the sensor bracket against the wall with the curved arms facing the door. Make sure there is enough clearance for the beam to be unobstructed. Mark holes.
2. Drill 3/16 inch pilot holes for each sensor bracket and attach the sensor brackets to the wall using lag screws (not provided).
3. Slide the carriage bolt into the slot on each sensor.
4. Insert the bolt through the hole in the sensor bracket and attach with the wing nut. The lenses on both sensors should point toward each other. Make sure the lens is not obstructed by the sensor bracket.

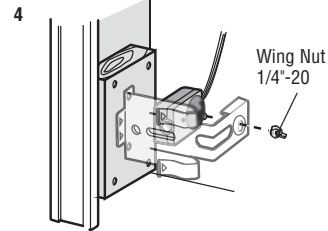
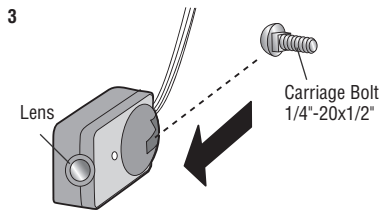
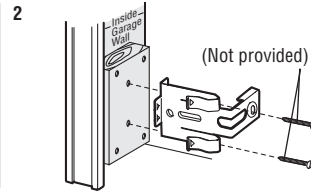
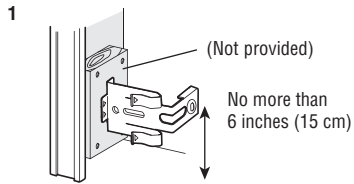

### OPTION C FLOOR INSTALLATION

Use an extension bracket (not provided) or wood block to raise the sensor bracket if needed.

1. Carefully measure the position of both sensor brackets so they will be the same distance from the wall and unobstructed.
2. Attach the sensor brackets to the floor using concrete anchors (not provided).
3. Slide the carriage bolt into the slot on each sensor.
4. Insert the bolt through the hole in the sensor bracket and attach with the wing nut. The lenses on both sensors should point toward each other. Make sure the lens is not obstructed by the sensor bracket.

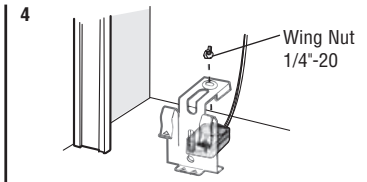
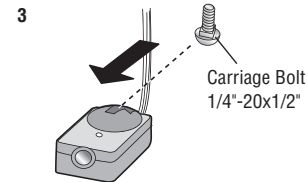
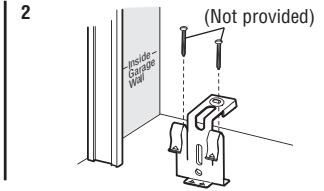
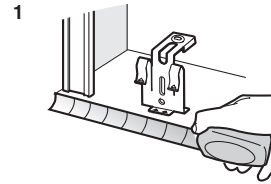



# Installation

## STEP 14 Wire the Safety Reversing Sensors

If your garage already has wires installed for the safety reversing sensors, proceed to page 25.

### HARDWARE

Insulated Staple  
(Not Shown)

### OPTION A INSTALLATION WITHOUT PRE-WIRING

1. Run the wire from both sensors to the garage door opener. Attach the wire to the wall and ceiling with the staples.
2. Strip 7/16 inch (11 mm) of insulation from each set of wires. Separate the wires. Twist the white wires together. Twist the white/black wires together.
3. Insert the white wires into the white terminal on the garage door opener. Insert the white/black wires into the grey terminal on the garage door opener. To insert or remove the wires from the terminal, push in the tab with a screwdriver tip.

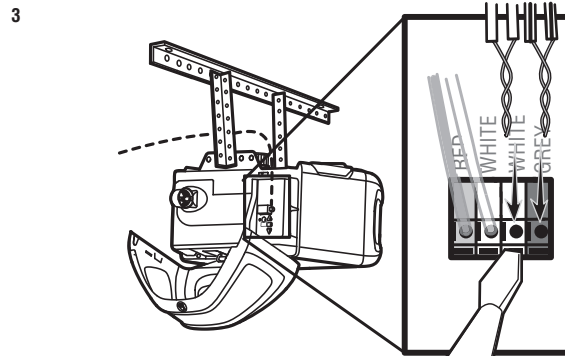
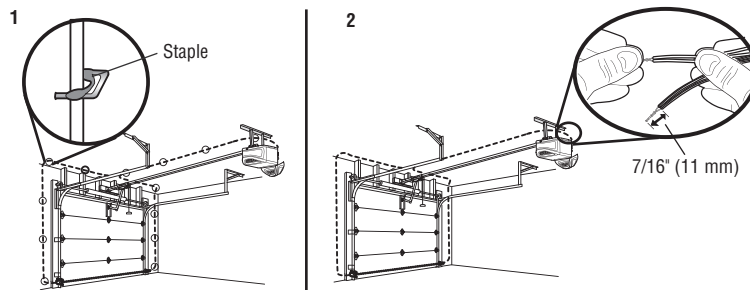

# Installation

## STEP 14 Wire the Safety Reversing Sensors (continued)

### OPTION B PRE-WIRED INSTALLATION

1. Cut the end of the safety reversing sensor wire, making sure there is enough wire to reach the pre-installed wires from the wall.
2. Separate the safety reversing sensor wires and strip 7/16 inch (11 mm) of insulation from each end. Choose two of the pre-installed wires and strip 7/16 inch (11 mm) of insulation from each end. Make sure that you choose the same color pre-installed wires for each sensor.
3. Connect the pre-installed wires to the sensor wires with wire nuts making sure the colors correspond for each sensor. For example, the white wire would connect to the yellow wire and the white/black wire would connect to the purple wire.
4. At the garage door opener, strip 7/16 inch (11 mm) of insulation from each end of the wires previously chosen for the safety reversing sensors. Twist the like-colored wires together.
5. Insert the wires connected to the white safety sensor wires to the white terminal on the garage door opener. Insert the wires that are connected to the white/black safety sensor wires to the grey terminal on the garage door opener.

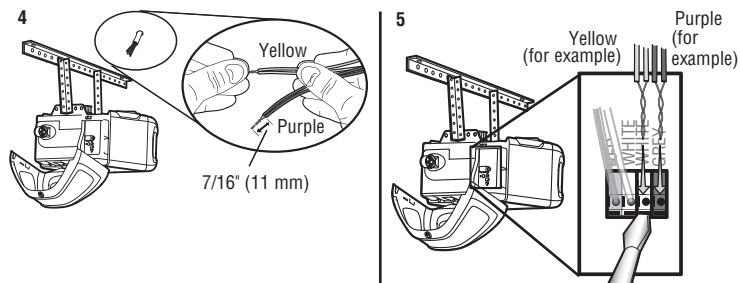
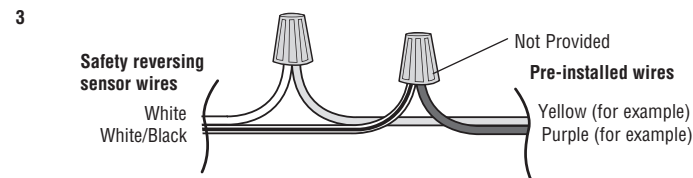
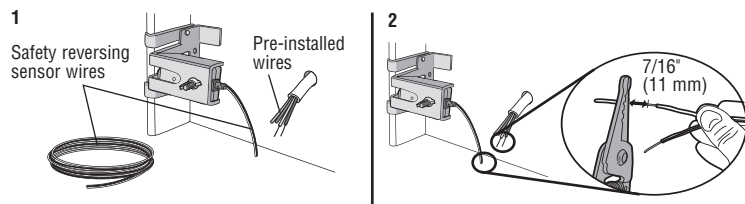

# Installation

## STEP 15 Connect power

### **WARNING**

To prevent possible **SERIOUS INJURY** or **DEATH** from electrocution or fire:

- Be sure power is **NOT** connected to the opener, and disconnect power to circuit **BEFORE** removing cover to establish permanent wiring connection.
- Garage door installation and wiring **MUST** be in compliance with **ALL** local electrical and building codes.
- **NEVER** use an extension cord, 2-wire adapter, or change plug in any way to make it fit outlet. Be sure the opener is grounded.

**To avoid installation difficulties, do not activate the garage door opener at this time.**

To reduce the risk of electric shock, your garage door opener has a grounding type plug with a third grounding pin. This plug will only fit into a grounding type outlet. If the plug doesn't fit into your outlet, contact a qualified electrician to install the proper outlet.

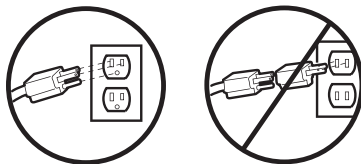

**THERE ARE TWO OPTIONS FOR CONNECTING POWER:**

### **OPTION A** TYPICAL WIRING

1. Plug in the garage door opener into a grounded outlet.
2. **DO NOT** run garage door opener at this time.

### **OPTION B** PERMANENT WIRING (Models manufactured before October 2012)

If permanent wiring is required by your local code, refer to the following procedure. To make a permanent connection through the 7/8 inch hole in the top of the motor unit (according to local code):

1. Be sure power is **NOT** connected to the opener, and disconnect power to circuit.
2. Remove the garage door opener cover and set aside.
3. Remove the attached green ground terminal.
4. Cut black and white wires and strip away 1/2 inch (1 cm) of insulation, 3 inch (7.5 cm) before spade terminals.
5. Remove the power cord from opener.
6. Install a conduit or flex cable adapter to the 7/8 inch hole.
7. Run wires through conduit, cut to proper length and strip insulation.
8. Attach with wire nuts provided. Attach the ground wire to the green ground screw. **The opener must be grounded.**
9. Properly secure wire under plastic ties so that wire does not come in contact with moving parts.
10. Reinstall the cover. **DO NOT** run garage door opener at this time.

#### PERMANENT WIRING

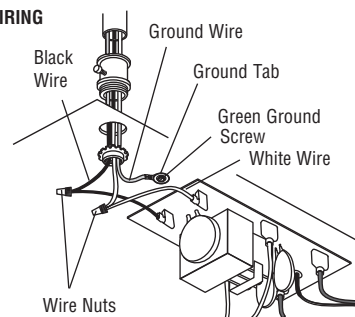

Refer to page 27 for models manufactured after October 2012.

# Installation

## OPTION B PERMANENT WIRING (Models manufactured after October 2012)

If permanent wiring is required by your local code, refer to the following procedure. To make a permanent connection through the 7/8 inch hole in the top of the motor unit (according to local code):

1. Remove the motor unit cover screws and set the cover aside.
2. Remove the attached 3-prong cord.
3. Connect the black (line) wire to the screw on the brass terminal; the white (neutral) wire to the screw on the silver terminal; and the ground wire to the green ground screw. **The opener must be grounded.**
4. Reinstall the cover.

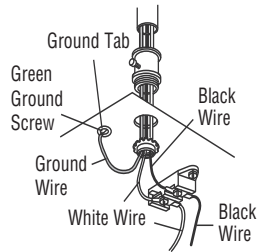

# Installation

## STEP 16 Ensure the safety reversing sensors are aligned

The door will not close if the sensors have not been installed and aligned correctly.

When the light beam is obstructed or misaligned while the door is closing, the door will reverse and the garage door opener lights will flash ten times. If the door is already open, it will not close. The sensors can be aligned by loosening the wing nuts, aligning the sensors, and tightening the wing nuts.

Check to make sure the LEDs in both sensors are glowing steadily. The LEDs in both sensors will glow steadily if they are aligned and wired correctly.

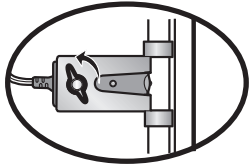

If the receiving sensor is in direct sunlight, switch it with sending sensor so it is on the opposite side of the door.

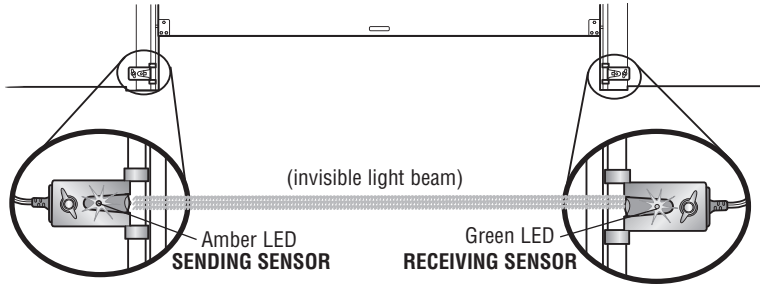

### IF THE AMBER LED ON THE SENDING SENSOR IS NOT GLOWING:

1. Make sure there is power to the garage door opener.
2. Make sure the sensor wire is not shorted/broken.
3. Make sure the sensor has been wired correctly: white wires to white terminal and white/black wires to grey terminal.

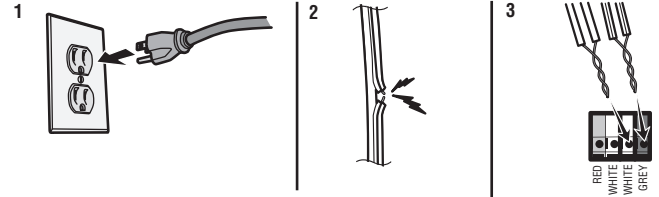

### IF THE GREEN LED ON THE RECEIVING SENSOR IS NOT GLOWING:

1. Make sure the sensor wire is not shorted/broken.
2. Make sure the sensors are aligned.

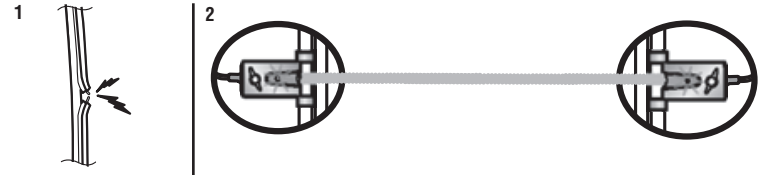

## STEP 17 Ensure the door control is wired correctly

If the door control has been installed and wired correctly, a message will display on the Smart Control Panel screen or the command LED on the Motion-Detecting Control Panel will blink.

# Adjustments

## Introduction

### **WARNING**

Without a properly installed safety reversal system, persons (particularly small children) could be **SERIOUSLY INJURED** or **KILLED** by a closing garage door.

- Incorrect adjustment of garage door travel limits will interfere with proper operation of safety reversal system.
- After ANY adjustments are made, the safety reversal system **MUST** be tested. Door **MUST** reverse on contact with 1-1/2" (3.8 cm) high object (or 2x4 laid flat) on floor.

### **CAUTION**

To prevent damage to vehicles, be sure fully open door provides adequate clearance.

Your garage door opener is designed with electronic controls to make setup and adjustments easy. The adjustments allow you to program where the door will stop in the open (UP) and close (DOWN) position. The electronic controls sense the amount of force required to open and close the door. The force is adjusted automatically when you program the travel.

If anything interferes with the door's upward travel it will stop. If anything interferes with the door's downward travel, it will reverse.

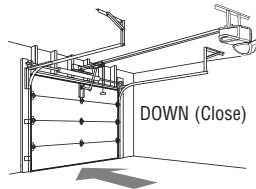
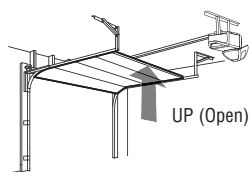

## One-Piece Doors Only

When setting the UP travel for a one-piece door ensure that the door does not slant backwards when fully open (UP). If the door is slanted backwards this will cause unnecessary bucking and/or jerking when the door is opening or closing.

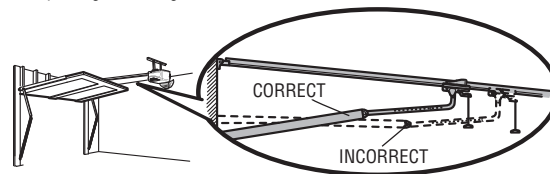

## Programming Buttons

The programming buttons are located on the left side panel of the garage door opener and are used to program the travel.

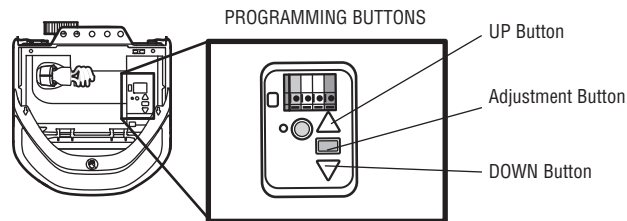

To watch a short instructional video on how to program the travel on your new garage door opener use your smartphone to read the QR Code:



# Adjustments

## STEP 1 Program the Travel

### WARNING

Without a properly installed safety reversal system, persons (particularly small children) could be SERIOUSLY INJURED or KILLED by a closing garage door.

- Incorrect adjustment of garage door travel limits will interfere with proper operation of safety reversal system.
- After ANY adjustments are made, the safety reversal system MUST be tested. Door MUST reverse on contact with 1-1/2" (3.8 cm) high object (or 2x4 laid flat) on floor.

1. Press and hold the Adjustment Button until the UP Button begins to flash and/or a beep is heard.
2. Press and hold the UP Button until the door is in the desired UP position. **NOTE:** The UP and DOWN Buttons can be used to move the door up and down as needed.
3. Once the door is in the desired UP position press and release the Adjustment Button. The garage door opener lights will flash twice and the DOWN Button will begin to flash.
4. Press and hold the DOWN Button until the door is in the desired DOWN position. **NOTE:** The UP and DOWN Buttons can be used to move the door up and down as needed.
5. Once the door is in the desired DOWN position press and release the Adjustment Button. The garage door opener lights will flash twice and the UP Button will begin to flash.
6. Press and release the UP Button. When the door travels to the programmed UP position, the DOWN Button will begin to flash.
7. Press and release the DOWN Button. The door will travel to the programmed DOWN position. Programming is complete.

\* If the garage door opener lights are flashing 5 times during the steps for Program the Travel, the programming has timed out. If the garage door opener lights are flashing 10 times during the steps for Program the Travel, the safety reversing sensors are misaligned or obstructed (refer to page 28). When the sensors are aligned and unobstructed, cycle the door through a complete up and down cycle using the remote control or the UP and DOWN buttons. Programming is complete. If you are unable to operate the door up and down, repeat the steps for Programming the Travel.

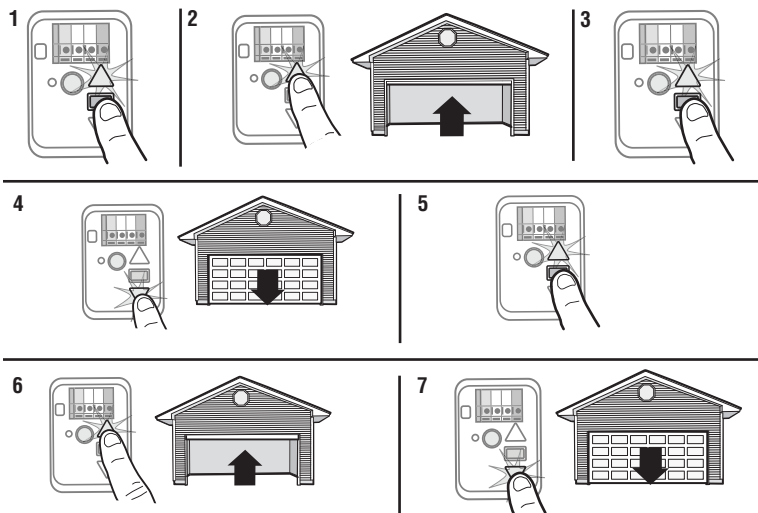
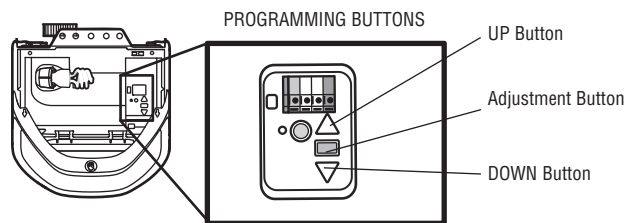

# Adjustments

## STEP 2 Test the Safety Reversal System

### **WARNING**

Without a properly installed safety reversal system, persons (particularly small children) could be **SERIOUSLY INJURED** or **KILLED** by a closing garage door.

- Safety reversal system **MUST** be tested every month.
- After **ANY** adjustments are made, the safety reversal system **MUST** be tested. Door **MUST** reverse on contact with 1-1/2" (3.8 cm) high object (or 2x4 laid flat) on the floor.

1. With the door fully open, place a 1-1/2 inch (3.8 cm) board (or a 2x4 laid flat) on the floor, centered under the garage door.
2. Press the remote control push button to close the door. The door **MUST** reverse when it makes contact with the board.

If the door stops and does not reverse on the obstruction, the down travel needs to be increased (refer to Adjustment Step 1). Repeat the test. When the door reverses upon contact with the 1-1/2 inch board, remove the board and open/close the door 3 or 4 times to test the adjustment. If the garage door opener continues to fail the safety reversal test, call a trained door systems technician.

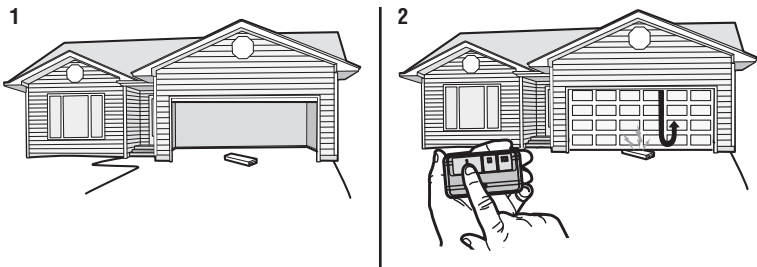

## STEP 3 Test the Protector System®

### **WARNING**

Without a properly installed safety reversing sensor, persons (particularly small children) could be **SERIOUSLY INJURED** or **KILLED** by a closing garage door.

1. Open the door. Place the garage door opener carton in the path of the door.
2. Press the remote control push button to close the door. The door will not move more than an inch (2.5 cm), and the garage door opener lights will flash 10 times.

The garage door opener will not close from a remote control if the LED in either safety reversing sensor is off (alerting you to the fact that the sensor is misaligned or obstructed). If the garage door opener closes the door when the safety reversing sensor is obstructed (and the sensors are no more than 6 inches [15 cm] above the floor), call for a trained door systems technician.

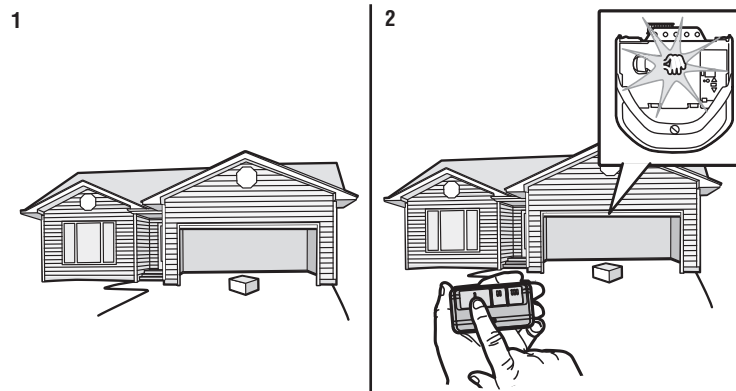



# Battery Backup

## STEP 1 Install the Battery

### **WARNING**

To reduce the risk of FIRE or INJURY to persons:

- Disconnect ALL electric and battery power BEFORE performing ANY service or maintenance.
- Use ONLY Chamberlain part # 41A6357-1 for replacement battery.
- DO NOT dispose of battery in fire. Battery may explode. Check with local codes for disposal instructions.

### **CAUTION**

ALWAYS wear protective gloves and eye protection when changing the battery or working around the battery compartment.

1. Unplug the garage door opener.
2. Open the light lens on the right side panel of the garage door opener. Use a Phillips head screwdriver to remove the battery cover on the garage door opener.
3. Partially insert the battery into the battery compartment with the terminals facing out.
4. Connect red (+) and black (-) wires from the garage door opener to the corresponding terminals on the battery.
5. Replace the battery cover.
6. Plug in the garage door opener.
7. Wait for the green Battery Status LED to start flashing before proceeding to test the battery.

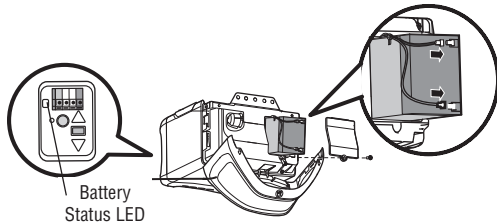

## STEP 2 Test the Battery

1. Unplug the garage door opener. The battery status LED will wither glow solid orange indicating opener is operating on battery power or will flash indicating low battery power. Make sure the garage door opener is unplugged.
2. Open and close the door using the remote control or door control. The garage door opener may run slower if the battery is not fully charged. The battery will take 24 hours to fully charge.
3. Plug in the garage door opener. Verify the battery status LED is flashing green, indicating the battery is charging.



# Battery Backup

## Charge the Battery

The battery charges when the garage door opener is plugged into a 110Vac electrical outlet that has power and requires 24 hours to fully charge. A fully charged battery supplies 12Vdc to the garage door opener for one to two days of normal operation during an electrical power outage. After the electrical power has been restored, the battery will recharge within 24 hours. The battery will last approximately 1 to 2 years with normal usage. Instructions for replacement are provided with the battery. To obtain maximum battery life and prevent damage, disconnect the battery when the garage door opener is unplugged for an extended period of time, such as a summer or winter home.

**NOTE:** When the garage door opener is in battery backup mode the garage door opener lights, Timer-to-Close, and Remote Close features are unavailable.

## Battery status LED

### GREEN LED:

All systems are normal.

- A solid green LED light indicates the battery is fully charged.
- A flashing green LED indicates the battery is being charged.

### ORANGE LED:

The garage door opener has lost power and is in battery backup mode.

- A solid orange LED with beep, sounding approximately every 2 seconds, indicates the garage door opener is operating on battery power.
- A flashing orange LED with beep, sounding every 30 seconds, indicates the battery is low.

### RED LED:

The garage door opener's 12V battery needs to be replaced.

- A solid red LED with beep, sounding every 30 seconds, indicates the 12V battery will no longer hold a charge and needs to be replaced. Replace the battery back up to maintain the battery backup feature.

**NOTE:** The Battery Status LED is most visible with the garage door opener light off. Battery does not have to be fully charged to operate the garage door opener.

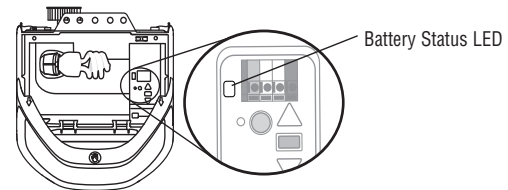

# IMPORTANT SAFETY INSTRUCTIONS



## To reduce the risk of SEVERE INJURY or DEATH:

1. READ AND FOLLOW ALL WARNINGS AND INSTRUCTIONS.
  2. ALWAYS keep remote controls out of reach of children. NEVER permit children to operate or play with garage door control push buttons or remote controls.
  3. ONLY activate garage door when it can be seen clearly, it is properly adjusted, and there are no obstructions to door travel.
  4. ALWAYS keep garage door in sight and away from people and objects until completely closed. NO ONE SHOULD CROSS THE PATH OF THE MOVING DOOR.
  5. NO ONE SHOULD GO UNDER A STOPPED, PARTIALLY OPENED DOOR.
  6. If possible, use emergency release handle to disengage trolley ONLY when garage door is CLOSED. Use caution when using the release with the door opener. Weak or broken springs or unbalanced door could result in an open door falling rapidly and/or unexpectedly and increasing the risk of SEVERE INJURY or DEATH.
  7. NEVER use emergency release handle unless garage doorway is clear of persons and obstructions.
  8. NEVER use handle to pull garage door open or closed. If rope knot becomes untied, you could fall.
  9. After ANY adjustments are made, the safety reversal system MUST be tested.
  10. Safety reversal system MUST be tested every month. Garage door MUST reverse on contact with 1-1/2" (3.8 cm) high object (or a 2x4 laid flat) on the floor. Failure to adjust the garage door opener properly increases the risk of SEVERE INJURY or DEATH.
  11. ALWAYS KEEP GARAGE DOOR PROPERLY BALANCED (see page 2). An improperly balanced door may NOT reverse when required and could result in SEVERE INJURY or DEATH.
  12. ALL repairs to cables, spring assemblies and other hardware, ALL of which are under EXTREME tension, MUST be made by a trained door systems technician.
  13. ALWAYS disconnect electric power to garage door opener BEFORE making ANY repairs or removing covers.
  14. This operator system is equipped with an unattended operation feature. The door could move unexpectedly. NO ONE SHOULD CROSS THE PATH OF THE MOVING DOOR.
  15. DO NOT enable the Timer-to-Close functionality if operating either one-piece or swinging garage doors. To be enabled ONLY when operating a sectional door.
- 16. SAVE THESE INSTRUCTIONS.**

# Operation

## Features

Your garage door opener is equipped with features to provide you with greater control over your garage door operation.

### Alert2Close

The Alert2Close feature provides a visual and an audible alert that an unattended door is closing.

### TIMER-TO-CLOSE (TTC)

The Timer-to-Close feature automatically closes the door after a specified time period that can be adjusted using the door control. **DO NOT enable TTC if operating a one-piece door. TTC is to be used ONLY with sectional doors.** Factory default is set to off. The garage door opener will beep and the lights will flash before closing the door. The TTC feature will deactivate if the garage door encounters an obstruction twice; or the safety reversing sensors are incorrectly installed. The garage door will reverse open and WILL NOT close until the obstructions are clear or the safety reversing sensors are correctly installed. When the obstruction has been cleared or the safety reversing sensors have been aligned, the door will close when the garage door opener is activated. TTC WILL NOT work if the garage door opener is operating by battery power or if the safety reversing sensors are misaligned. This feature is NOT intended to be the primary method of closing the door. **A keyless entry should be installed in the event of an accidental lock out when using this feature.**

### MyQ®

MyQ® technology uses a 900MHz signal to provide two-way communication between the garage door opener and MyQ® enabled accessories. Your garage door opener is compatible with up to 8 MyQ® accessories.

### REMOTE CONTROLS AND DOOR CONTROLS (MyQ®)

Your garage door opener has already been programmed at the factory to operate with your remote control, which changes with each use, randomly accessing over 100 billion new codes. Compatible with MyQ® enabled accessories, see page 44.

**NOTE:** Older Chamberlain remote controls, door controls, and third party products are not compatible.

MyQ® Accessories	MEMORY CAPACITY
Remote Controls	Up to 8
Door Controls	Up to 2 MyQ® door controls
Keyless Entries	Up to 1

## THE PROTECTOR SYSTEM® (SAFETY REVERSING SENSORS)

When properly connected and aligned, the safety reversing sensors will detect an obstruction in the path of the infrared beam. If an obstruction breaks the infrared beam while the door is closing, the door will stop and reverse to full open position, and the opener lights will flash 10 times. If the door is fully open, and the safety reversing sensors are not installed, or are misaligned, the door will not close from a remote control. However, you can close the door if you hold the button on the door control or keyless entry until the door is fully closed. The safety reversing sensors do not effect the opening cycle.

## ENERGY CONSERVATION

For energy efficiency the garage door opener will enter sleep mode when the door is fully closed. The sleep mode shuts the garage door opener down until activated. The sleep mode is sequenced with the garage door opener light bulb; as the light bulb turns off the sensor LEDs will turn off and whenever the garage door opener lights turn on the sensor LEDs will light. The garage door opener will not go into the sleep mode until the garage door opener has completed 5 cycles upon power up.

## LIGHTS

The garage door opener light bulbs will turn on when the opener is initially plugged in; power is restored after interruption, or when the garage door opener is activated. The lights will turn off automatically after 4-1/2 minutes. An incandescent A19 light bulb (100 watt maximum) or for maximum energy efficiency a 26W (100W equivalent) compact fluorescent light (CFL) bulb may be used. **NOTE: Do not use halogen, short neck, or specialty light bulbs as these may overheat the end panel or light socket. Do not use LED bulbs as they may reduce the range or performance of your remote controls.**

### Light Feature

The garage door opener is equipped with an added feature; the lights will turn on when someone enters through the open garage door and the safety reversing sensor infrared beam is broken. For added control over the light bulbs on your garage door opener, see page 36 and 37.

## BATTERY BACKUP

The battery backup system allows access in and out of your garage, even when the power is out. When the garage door opener is operating on battery power, the garage door opener will run slower, the light will not function, the Battery Status LED will glow solid orange, and a beep will sound approximately every 2 seconds.

# Operation

## Using your Garage Door Opener

The garage door opener can be activated through a wall-mounted door control, remote control, wireless keyless entry or MyQ® accessory.

When the door is closed and the garage door opener is activated the door will open. If the door senses an obstruction or is interrupted while opening the door will stop. When the door is in any position other than closed and the garage door opener is activated the door will close. If the garage door opener senses an obstruction while closing, the door will reverse. If the obstruction interrupts the sensor beam the garage door opener lights will blink 10 times. However, you can close the door if you hold the button on the door control or keyless entry until the door is fully closed. The safety reversing sensors do not affect the opening cycle.

The safety reversing sensor must be connected and aligned correctly before the garage door opener will move in the down direction.

## Using the Motion Detecting Control Panel

### SYNCHRONIZE THE DOOR CONTROL

To synchronize the door control to the garage door opener, press the push bar until the garage door opener activates (it may take up to 3 presses). Test the door control by pressing the push bar, each press of the push bar will activate the garage door opener.

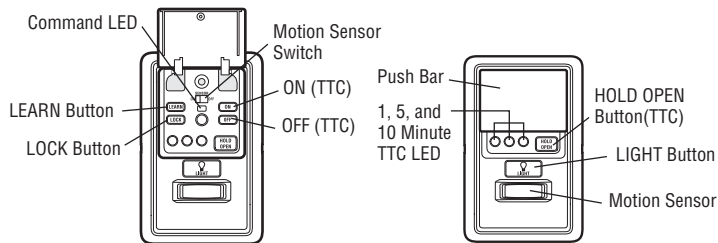

### MOTION DETECTING CONTROL PANEL FEATURES

#### PUSH BAR

Press the push bar to open or close the door.

#### LIGHTS

##### Light Button

Press the LIGHT button to turn the garage door opener lights on or off. When the lights are turned on they will stay on until the LIGHT button is pressed again, or until the garage door opener is activated. Once the garage door opener is activated the lights will turn off after the specified period of time (the factory setting is 4-1/2 minutes). The LIGHT button will not control the lights when the door is in motion.

##### To change the amount of time the garage door opener lights will stay on:

Press and hold the LOCK button (approximately 10 seconds) until the garage door opener lights flash. The time interval is indicated by the number times the garage door opener flashes:

- 1 flash is 1-1/2 minutes
- 2 flashes is 2-1/2 minutes
- 3 flashes is 3-1/2 minutes
- 4 flashes is 4-1/2 minutes

To cycle through the time intervals repeat the step above.

##### Light Feature

The lights will turn on when someone enters through the open garage door and the safety reversing sensor infrared beam is broken.

- **Deactivate:** Press and hold the LIGHT button (approximately 10 seconds) until the garage door opener lights turn on, then off again.
- **Activate:** Start with the garage door opener lights on. Press and hold the LIGHT button (approximately 10 seconds) until the garage door opener lights turn off, then on again.

If the command LED is continuously blinking, the LOCK feature needs to be deactivated.

# Operation

## Motion Detecting Control Panel (continued)

### LOCK

The LOCK feature is designed to prevent activation of the garage door opener from remote controls while still allowing activation from the door control and keyless entry. This feature is useful for added peace of mind when the home is empty (i.e. vacation).

- **Activate:** Press and hold the LOCK button for 2 seconds. The command LED will flash as long as the lock feature is activated and your handheld remote control will not operate your door at this time.
- **Deactivate:** Press and hold the LOCK button again for 2 seconds. The command LED will stop flashing and normal operation will resume.

### TIMER-TO-CLOSE

**DO NOT enable TTC if operating a one-piece door.** The TTC can be turned on or off and the time interval can be adjusted to 1, 5, and 10 minute intervals. Once the TTC has been set and the door is open, the selected close interval will blink and begin to count down to close the door.

- **Activate:** Press and hold the ON button until one of the TTC LEDs light up. Then press the ON button again to cycle through the time interval options (the corresponding TTC LED will light for each time interval). The garage door opener light bulbs will blink as confirmation.
- **Deactivate:** Press and hold the OFF button until all TTC LEDs turn off and a beep is heard from the motor unit.
- **Temporarily hold door open (suspend TTC):** Press and release the HOLD OPEN button. Press the HOLD OPEN button again to resume normal TTC operation.

### PROGRAM

Any compatible remote controls, wireless keyless entry, or MyQ™ accessories can be programmed to the garage door opener by pressing the Learn button.

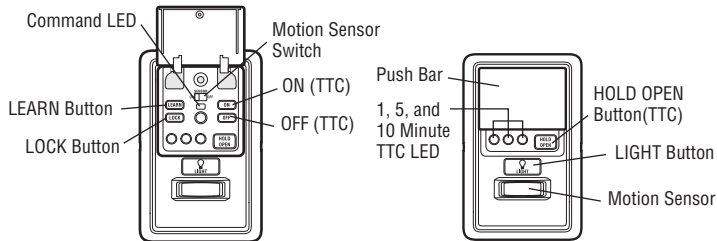

## Using the Smart Control Panel

### SYNCHRONIZE THE DOOR CONTROL

To synchronize the door control to the garage door opener, press the push bar until the garage door opener activates (it may take up to 3 presses). Test the door control by pressing the push bar, each press of the push bar will activate the garage door opener.

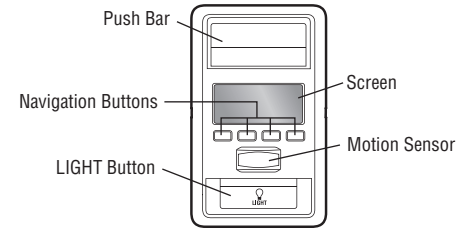

### SMART CONTROL PANEL FEATURES

#### PUSH BAR

Press the push bar to open or close the door.

#### LIGHTS

##### Light Button

Press the LIGHT button to turn the garage door opener lights on or off. When the lights are turned on they will stay on until the LIGHT button is pressed again, or until the garage door opener is activated. Once the garage door opener is activated the lights will turn off after the specified period of time (the factory setting is 4-1/2 minutes). The LIGHT button will not control the lights when the door is in motion. The duration of the light timing can be adjusted by accessing the menu using the navigation buttons.

##### Motion Sensor

The motion sensor will automatically turn on the garage door opener lights when motion is detected. The lights will come on for the set period of time, then shut off. The factory setting is on and set at 4-1/2 minutes.

# Operation

## Using the Smart Control Panel (continued)

### Light Feature

The lights will turn on when someone enters through the open garage door and the safety reversing sensor infrared beam is broken. If using the garage door opener light as a work light, turn the light on using the light button on the wall control or the light will turn off if you are beyond the range of the sensor.

### LOCK

The LOCK feature is designed to prevent activation of the garage door opener from remote controls while still allowing activation from the door control and keyless entry. This feature is useful for added peace of mind when the home is empty (i.e. vacation).

When the Lock feature is on, your remote controls have been disabled and a message will display on the door control (Figure 1).

### TIMER-TO-CLOSE (TTC)

**DO NOT enable TTC if operating a one-piece door.** TTC can be set to automatically close your garage door from the fully open position after a specified period of time (1, 5, 10 minute intervals or a custom setting up to 99 minutes). The screen on the door control can display the status of the TTC. Once the TTC has been set and the door is open, the selected close interval will be displayed on the screen and toggle between the time and TTC message. When the TTC is on, a message will display on the door control screen (Figure 2).

To temporarily suspend the TTC feature press and release the HOLD button. Press REL button to resume normal TTC operation (Figure 3).

### BATTERY BACKUP

If your garage door opener has a battery backup one of two messages will display on the door control if there is a problem with the battery (Figures 4 and 5).

Figure 1

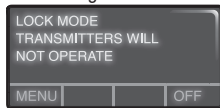

Figure 2

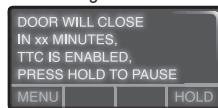

Figure 3

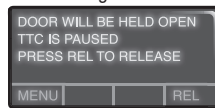

Figure 4

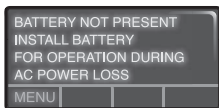
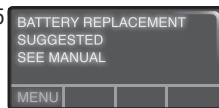
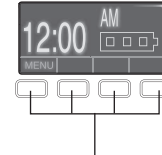
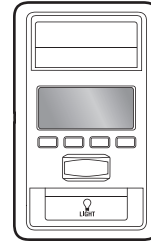

Figure 5



## SMART CONTROL PANEL MENU

The features on the door control can be programmed through a series of menus on the screen and the navigation buttons.



### Screen

The screen will display the time, temperature, and current battery charge (if applicable) until the menu button is pressed, and then it will display the menu options. If there is a problem with the garage door opener the screen will display the Diagnostic Code.

### Navigation Buttons

Use the navigation buttons to make selections and program features.

## FEATURES MENU

Press the navigation button below "MENU" to view the Features menu.



Set the time, choose 12 or 24 hour clock and show/hide clock.

Set the Timer-to-Close feature off/on and set the time interval before door closes.

Enable/disable lock.

Add remote controls, MyQ™ devices, an extra remote button to control your garage door opener lights, or a keyless entry.

## SETTINGS MENU

Press the navigation button below the down arrow till you see TEMPERATURE to view the Settings menu.



Display the temperature in Fahrenheit or Celsius and show/hide the temperature.

Select a language.

Set duration for garage door opener light to stay on after operation, selectable range of 1-1/2 to 4-1/2 minutes. Turn the Motion sensor off/on, and turn the entry light feature off/on.

Adjust the contrast of the screen.

# Operation

## Remote Control

Your remote control has been programmed at the factory to operate with your garage door opener.

Older Chamberlain remote controls are NOT compatible, see page 44 for compatible accessories. Programming can be done through the door control or the learn button the garage door opener. To program additional accessories refer to the instructions provided with the accessory or visit [www.chamberlain.com](http://www.chamberlain.com). If your vehicle is equipped with a Homelink®, you may require an external adapter depending on the make, model, and year of your vehicle. Visit [www.homelink.com](http://www.homelink.com) for additional information.

## TO ADD, REPROGRAM, OR CHANGE A REMOTE CONTROL/KEYLESS ENTRY PIN USING THE MOTION-DETECTING CONTROL PANEL

1. Press the LEARN button on the door control to enter Programming Mode.
2. Press the LEARN button again, the LED will flash once.
3. **Remote Control:**

Press the button on the remote control that you wish to operate your garage door.

### Keyless Entry:

Enter a 4-digit personal identification number (PIN) of your choice on the keyless entry keypad. Then press the ENTER button.

The garage door opener lights will flash (or two clicks will be heard) when the code has been programmed. Repeat the steps for programming additional remote controls or keyless entry devices.

- 1 The command LED will flash once.

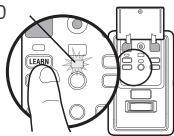

- 2 The command LED will flash once again.

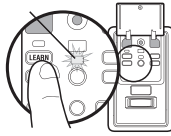

3

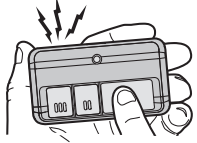

OR

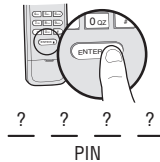

## TO ADD, REPROGRAM, OR CHANGE A REMOTE CONTROL/KEYLESS ENTRY PIN USING THE SMART CONTROL PANEL

1. Press the navigation button below "MENU" to view the Features menu.
2. Use the navigation buttons to scroll to "PROGRAM".
3. Select "REMOTE" or "KEYPAD" to program from the program menu.
4. **Remote Control:**

Press the button on the remote control that you wish to operate your garage door.

### Keyless Entry:

Enter a 4-digit personal identification number (PIN) of your choice on the keyless entry keypad. Then press the ENTER button.

The garage door opener lights will flash (or two clicks will be heard) when the code has been programmed. Repeat the steps for programming additional remote controls or keyless entry devices. If programming is unsuccessful, program the remote using the learn button.

1

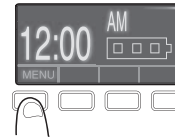

2

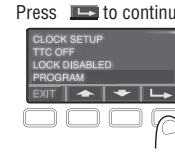

3

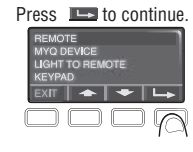

4



OR

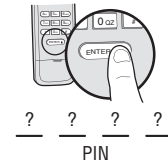



# Operation

## Remote Control (continued)

### PROGRAM A REMOTE CONTROL USING THE LEARN BUTTON

1. Locate the Learn Button.
2. Press and immediately release the Learn button. The Learn LED will glow steady for 30 seconds. Within 30 seconds...
3. Press and hold the button on the remote control that you wish to use. Release the button when the garage door opener lights blink or two clicks are heard. When replacing the light lens cover, ensure the antenna wires are hanging straight down.

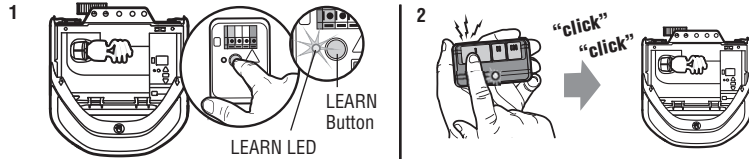

## To Erase the Memory

### ERASE ALL REMOTE CONTROLS AND KEYLESS ENTRIES

1. Press and hold the learn button on garage door opener until the learn LED goes out (approximately 6 seconds). All remote control and keyless entry codes are now erased. Reprogram any accessory you wish to use.

### ERASE ALL DEVICES (Including MyQ® enabled accessories)

1. Press and hold the learn button on garage door opener until the learn LED goes out (approximately 6 seconds).
2. Immediately press and hold the learn button again until the learn LED goes out. All codes are now erased. Reprogram any accessory you wish to use.

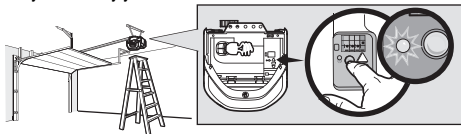

## To Open the Door Manually

### **WARNING**

To prevent possible **SERIOUS INJURY** or **DEATH** from a falling garage door:

- If possible, use emergency release handle to disengage trolley **ONLY** when garage door is **CLOSED**. Weak or broken springs or unbalanced door could result in an open door falling rapidly and/or unexpectedly.
- **NEVER** use emergency release handle unless garage doorway is clear of persons and obstructions.
- **NEVER** use handle to pull door open or closed. If rope knot becomes untied, you could fall.

### DISCONNECT THE TROLLEY

1. The door should be fully closed if possible.
2. Pull down on the emergency release handle so the trolley release arm snaps to the vertical position. The door can now be raised and lowered as often as necessary.

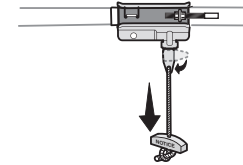

### RECONNECT THE TROLLEY

1. Pull the emergency release handle toward the garage door opener so the trolley release arm snaps to the horizontal position. The trolley will reconnect on the next UP or DOWN operation, either manually or by using the door control or remote control.

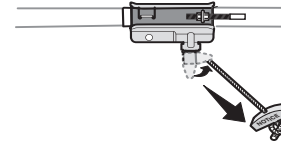

# Maintenance

## Maintenance Schedule

### EVERY MONTH

- Manually operate door. If it is unbalanced or binding, call a trained door systems technician.
- Check to be sure door opens and closes fully. Adjust if necessary, see page 29.
- Test the safety reversal system. Adjust if necessary, see page 29.

### EVERY YEAR

- Oil door rollers, bearings and hinges. The garage door opener does not require additional lubrication. Do not grease the door tracks.
- Test the battery backup and consider replacing the battery to ensure the garage door opener will operate during an electrical power outage, see page 32 to test the battery backup.

## The Remote Control Battery

### WARNING

To prevent possible **SERIOUS INJURY** or **DEATH**:

- NEVER allow small children near batteries.
- If battery is swallowed, immediately notify doctor.

To reduce risk of fire, explosion or chemical burn:

- Replace **ONLY** with 3V2032 coin batteries.
- **DO NOT** recharge, disassemble, heat above 212°F (100°C) or incinerate.

The 3V2032 lithium battery should produce power for up to 5 years. If the battery is low, the remote control's LED will not flash when the button is pressed.

To replace battery, pry open the case first in the middle (1), then at each side (2 and 3) with the visor clip.

Replace the batteries with only 3V2032 coin cell batteries. Insert battery positive side up. Dispose of old batteries properly.

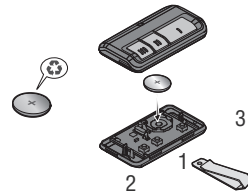

NOTICE: To comply with FCC and/or Industry Canada (IC) rules, adjustment or modifications of this transceiver are prohibited. THERE ARE NO USER SERVICEABLE PARTS. Any changes or modifications not expressly approved by the party responsible for compliance could void the user's authority to operate the equipment.

This device complies with Part 15 of the FCC rules and IC RSS-210. Operation is subject to the following two conditions: (1) this device may not cause harmful interference, and (2) this device must accept any interference received, including interference that may cause undesired operation.

This Class B digital apparatus complies with Canadian ICES-003.

AVIS: Les règles de la FCC et/ou d'Industrie Canada (IC) interdisent tout ajustement ou toute modification de ce récepteur. IL N'EXISTE AUCUNE PIÈCE SUSCEPTIBLE D'ÊTRE ENTRETENUE PAR L'UTILISATEUR. Tout changement ou toute modification non expressément approuvé par la partie responsable de la conformité peut avoir pour résultat d'annuler l'autorité de l'utilisateur de faire fonctionner l'équipement.

Cet appareil est conforme aux dispositions de la partie 15 du règlement de la FCC et de l' norme IC RSS-210. Son utilisation est assujettie aux deux conditions suivantes: (1) ce dispositif ne peut causer des interférences nuisibles, et (2) ce dispositif doit accepter toute interférence reçue, y compris une interférence pouvant causer un fonctionnement non souhaité.

Cet appareil numérique de la classe B est conforme à la norme NMB-003 du Canada.

# Troubleshooting

## Diagnostic Chart

Your garage door opener is programmed with self-diagnostic capabilities. The UP and DOWN arrows on the garage door opener flash the diagnostic codes.

DIAGNOSTIC CODE		SYMPTOM	SOLUTION
Up Arrow Flash(es)	Down Arrow Flash(es)		
1	1	The garage door opener will not close and the light bulbs flash.	Safety sensors are not installed, connected, or wires may be cut. Inspect sensor wires for a disconnected or cut wire.
1	2	The garage door opener will not close and the light bulbs flash.	There is a short or reversed wire for the safety sensors. Inspect safety sensor wire at all staple and connection points, replace wire or correct as needed
1	3	The door control will not function.	The wires for the door control are shorted or the door control is faulty. Inspect safety sensor wire at all staple points and connection points and replace wire or correct as needed.
1	4	The garage door opener will not close and the light bulbs flash.	Safety sensors are misaligned or were momentarily obstructed. Realign both sensors to ensure both LEDs are steady and not flickering. Make sure nothing is hanging or mounted on the door that would interrupt the sensor's path while closing.
1	5	Door moves 6-8" stops or reverses.	Manually open and close the door. Check for binding or obstructions, such as a broken spring or door lock, correct as needed. Check wiring connections at travel module and at the logic board. Replace travel module if necessary.
		No movement, only a single click.	Manually open and close the door. Check for binding or obstructions, such as a broken spring or door lock, correct as needed. Replace logic board if necessary.
		Opener hums for 1-2 seconds no movement.	Manually open and close the door. Check for binding or obstructions, such as a broken spring or door lock, correct as needed. Replace motor if necessary.
1	6	Door coasts after it has come to a complete stop.	Program travel to coasting position or have door balanced by a trained door systems technician.
2	1-5	No movement, or sound.	Replace logic board.
3	2	Unable to set the travel or retain position.	Check travel module for proper assembly, replace if necessary.
3	3	The battery status LED is constantly flashing green.	Battery backup charging circuit error, replace the logic board.

# Troubleshooting

DIAGNOSTIC CODE		SYMPTOM	SOLUTION
Up Arrow Flash(es)	Down Arrow Flash(es)		
4	1-4	Door is moving stops or reverses.	Manually open and close the door. Check for binding or obstructions, such as a broken spring or door lock, correct as needed. If the door is binding or sticking contact a trained door systems technician. If door is not binding or sticking attempt to reprogram travel (refer to page 29).
4	5	Opener runs approximately 6-8", stops and reverses.	Communication error to travel module. Check travel module connections, replace travel module if necessary.
4	6	The garage door opener will not close and the light bulbs flash.	Safety sensors are misaligned or were momentarily obstructed. Realign both sensors to ensure both LEDs are steady and not flickering. Make sure nothing is hanging or mounted on the door that would interrupt the sensor's path while closing.

## The garage door opener can beep for several reasons:

- Operating on battery power or the 12 Vdc battery needs to be replaced, see page 32.
- Garage door opener has been activated through a device or feature such as Timer-to-Close or garage door monitor, see page 35.

## My remote control will not activate the garage door:

- Verify the lock feature is not activated on the door control.
- Reprogram the remote control.
- If the remote control will still not activate the door check the diagnostic codes to ensure the garage door opener is working properly.

## My door will not close and the light bulbs blink on my motor unit:

The safety reversing sensor must be connected and aligned correctly before the garage door opener will move in the down direction.

- Verify the safety sensors are properly installed, aligned and free of any obstructions.

## My garage door opener light(s) will not turn off when the door is open:

The garage door opener is equipped with a feature that turns the light on when the safety reversing sensors have been obstructed or when the motion sensor on the door control detects movement in the garage. These features can be disabled using the door control, see page 35.

## My neighbor's remote control opens my garage door:

Erase the memory from your garage door opener and reprogram the remote control(s).

## The LEDs on the door control blink:

If you have a Smart Control Panel installed and the TTC is set to a custom time, press the ON button on the Premium Motion-Detecting Control Panel to set the time properly.

## My vehicle's Homelink® is not programming to my garage door opener:

Depending on the make, model, and year of your vehicle an external adapter may be required. Visit [www.homelink.com](http://www.homelink.com) for additional information.

# Accessories

**7702CB Outside Quick Release:**  
Required for a garage with NO access door.



**41A5281 Extension Brackets:**  
(Optional) For safety reversing sensor installation onto the wall or floor.



**8808CB 8 Foot (2.4 m) Rail Extension:**  
To allow an 8 foot (2.4 m) door to open fully.

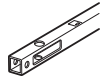

**PILCEV MyQ® Remote Light Control:**  
Control home lighting and garage doors with one remote. For use with plug-in lamps. Synchronize to work with MyQ® compatible garage door openers and remote controls.



**8810CB 10 Foot (3 m) Rail Extension:**  
To allow a 10 foot (3 m) door to open fully.

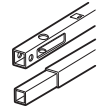

**CLLP1 Laser Parking Assistant:**  
Park in the right spot every time! A laser beam is activated by your garage door opener and projected on to the dashboard of your vehicle to guide perfect parking.



**41A6357-1 Standby Power System Battery:**  
Provides backup power to the garage door opener.



**CLSS1 System Surge Protector:**  
The Garage Door Opener Surge Protector is designed to protect Chamberlain garage door openers against damage from lightning and power surges. Easy to install.



**AGDMEV Garage Door and Gate Monitor:**  
Monitor open/closed status for up to 4 MyQ® compatible garage door openers and close them from anywhere in the home.



**BIK01 Installation Upgrade Kit:**  
The Installation Upgrade Kit includes all components needed to hang garage door openers up to 24" (61 cm) from the ceiling.



**953EV Remote Control:**  
Works with ALL Chamberlain openers from 1993-present. MyQ® compatible. Includes visor clip.



**956EV Keychain Remote Control:**  
Works with ALL Chamberlain openers from 1993-present. MyQ® compatible. With key ring.



**940EV Wireless Keypad:**  
For use outside of the home to enable access to the garage using a 4-digit PIN. Works with ALL Chamberlain openers from 1993-present. MyQ® compatible.



# Warranty

## Contact Information

For installation and service information call:

**1-800-528-9131**

Before calling, please have the model number of the garage door opener. If you are calling about a Troubleshooting issue, it is recommended that you have access to your garage door opener while calling. If you are ordering a repair part please have the following information: part number, part name, and model number.

Address repair parts orders to:  
**The Chamberlain Group, Inc.**  
**6050 S. Country Club Road**  
**Tucson, AZ 85706**

### CHAMBERLAIN® FIVE YEAR LIMITED WARRANTY LIFETIME MOTOR AND BELT LIMITED WARRANTY ONE YEAR LIMITED WARRANTY FOR THE BATTERY BACKUP SYSTEM

The Chamberlain Group, Inc. ("Seller") warrants to the first retail purchaser of this product, for the residence in which this product is originally installed, that it is free from defects in materials and/or workmanship for a period of five years from the date of purchase, except that the motor and belt are warranted to be free from defects in materials and/or workmanship for the lifetime of the product while you own your residence, and the Battery Backup System is warranted to be free from defects in materials and/or workmanship for a period of one year from the date of purchase. The proper operation of this product is dependent on your compliance with the instructions regarding installation, operation, and maintenance and testing. Failure to comply strictly with those instructions will void this limited warranty in its entirety.

If, during the limited warranty period, this product appears to contain a defect covered by this limited warranty, call 1-800-528-9131, toll free, before dismantling this product. You will be advised of disassembly and shipping instructions when you call. Then send the product or component, pre-paid and insured, as directed to our service center for warranty repair. Please include a brief description of the problem and a dated proof-of-purchase receipt with any product returned for warranty repair. Products returned to Seller for warranty repair, which upon receipt by Seller are confirmed to be defective and covered by this limited warranty, will be repaired or replaced (at Seller's sole option) at no cost to you and returned pre-paid. Defective parts will be repaired or replaced with new or factory rebuilt parts at Seller's sole option. [You are responsible for any costs incurred in removing and/or reinstalling the product or any component.]

**ALL IMPLIED WARRANTIES FOR THE PRODUCT, INCLUDING BUT NOT LIMITED TO ANY IMPLIED WARRANTIES OF MERCHANTABILITY AND FITNESS FOR A PARTICULAR PURPOSE, ARE LIMITED IN DURATION TO THE APPLICABLE LIMITED WARRANTY PERIOD SET FORTH ABOVE FOR THE RELATED COMPONENT(S), AND NO IMPLIED WARRANTIES WILL EXIST OR APPLY AFTER SUCH PERIOD. Some States do not allow limitations on how long an implied warranty lasts, so the above limitation may not apply to you. THIS LIMITED WARRANTY DOES NOT COVER NON-DEFECT DAMAGE, DAMAGE CAUSED BY IMPROPER INSTALLATION, OPERATION OR CARE (INCLUDING, BUT NOT LIMITED TO ABUSE, MISUSE, FAILURE TO PROVIDE REASONABLE AND NECESSARY MAINTENANCE, UNAUTHORIZED REPAIRS OR ANY ALTERATIONS TO THIS PRODUCT), LABOR CHARGES FOR REINSTALLING A REPAIRED OR REPLACED UNIT, REPLACEMENT OF CONSUMABLE ITEMS (E.G., BATTERIES IN REMOTE CONTROL TRANSMITTERS AND LIGHT BULBS), OR UNITS INSTALLED FOR NON-RESIDENTIAL USE. THIS LIMITED WARRANTY DOES NOT COVER ANY PROBLEMS WITH, OR RELATING TO, THE GARAGE DOOR OR GARAGE DOOR HARDWARE, INCLUDING BUT NOT LIMITED TO THE DOOR SPRINGS, DOOR ROLLERS, DOOR ALIGNMENT OR HINGES. THIS LIMITED WARRANTY ALSO DOES NOT COVER ANY PROBLEMS CAUSED BY INTERFERENCE. UNDER NO CIRCUMSTANCES SHALL SELLER BE LIABLE FOR CONSEQUENTIAL, INCIDENTAL OR SPECIAL DAMAGES ARISING IN CONNECTION WITH USE, OR INABILITY TO USE, THIS PRODUCT. IN NO EVENT SHALL SELLER'S LIABILITY FOR BREACH OF WARRANTY, BREACH OF CONTRACT, NEGLIGENCE OR STRICT LIABILITY EXCEED THE COST OF THE PRODUCT COVERED HEREBY. NO PERSON IS AUTHORIZED TO ASSUME FOR US ANY OTHER LIABILITY IN CONNECTION WITH THE SALE OF THIS PRODUCT.**

Some states do not allow the exclusion or limitation of consequential, incidental or special damages, so the above limitation or exclusion may not apply to you. This limited warranty gives you specific legal rights, and you may also have other rights, which vary from state to state.

# Repair Parts

## Rail Assembly Parts

Description	Part Number
1 Belt	41A5250
2 Pulley	144C54
3 Master Link	4A1008
4 Rail	41A5665
5 Trolley Assembly	41C5141-1
6 "U" Bracket	12D598-1
<b>Not Shown</b>	
Wear Pads	183A163
Spring Retainer	41B4103-2
Hardware Bag	041A7920-2
Owner's Manual	114A4242

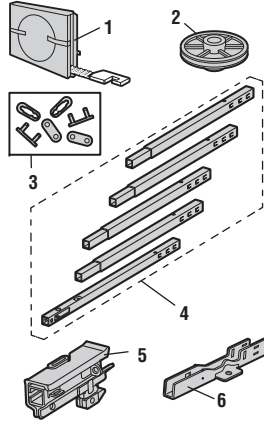

## Accessories

Description	Part Number
1 Motion-Detecting Control Panel	41A7327-1
2 Smart Control Panel®	41A7305-1
3 Remote Control	953ESTD

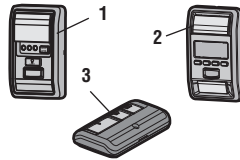

## Installation Parts

Description	Part Number
1 Curved Door Arm	178B35
2 Door Bracket with Clevis Pin and Fastener	41A5047-1
3 Emergency Release Rope and Handle	41A2828
4 Header Bracket with Clevis Pin and Fastener	41A5047-2
5 Remote Control Visor Clip	29B137
6 Safety Sensor Bracket	41A5266-1
7 Safety Sensor Kit Receiving and sending sensors with wire	41A5034
8 Straight Door Arm	178B34
9 White and Red/White Wire	41B4494-1
10 3V2030 Lithium Battery	10A20
11 Hanging Brackets	12B776

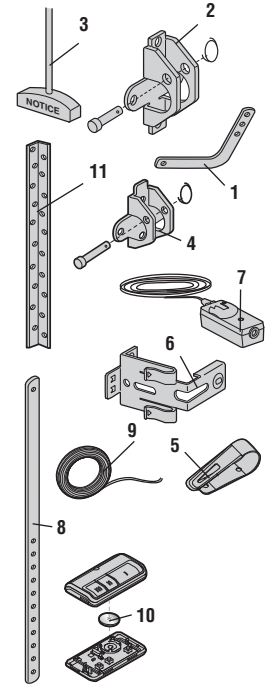

# Repair Parts

## Garage Door Opener Parts

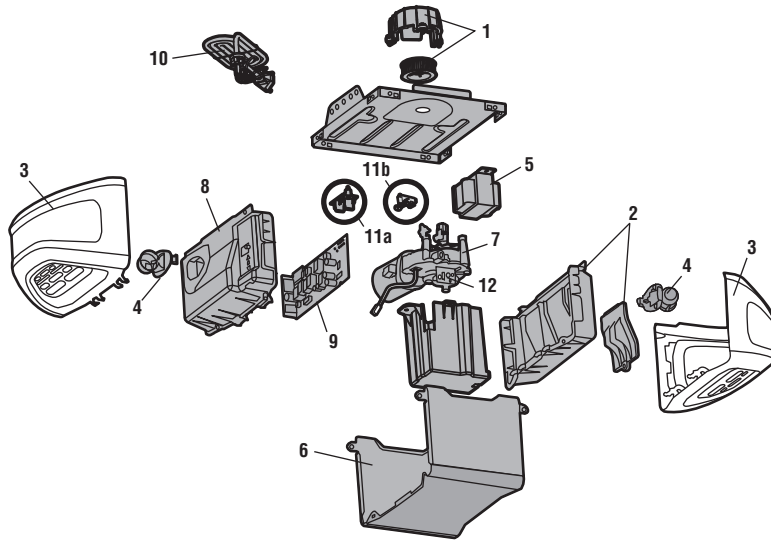

Description	Part Number
1 Sprocket and Sprocket Cover with Screws (Model HD930EV ONLY) Sprocket and Sprocket Cover with Screws (All other models)	041C1751 41C589-2
2 End Panel with light socket	41D7639
3 Light Lens Model WD962KEV/KPEV/MLEV Model HD920EV/HD930EV Model LW5000EV	41D7570 41D7572 41D7571
4 Light Socket	41C279
5 Transformer	41A7635
6 Cover Model WD962KEV/KPEV/MLEV Model HD920EV Model LW5000EV Model HD930EV	41A7620-6 41A7620-3 41A7620 041A7620-15
7 Motor with Travel Module	41D1739-1
8 End Panel for Receiver Logic Board with light socket	41D7638
9 Receiver Logic Board (Model HD930EV ONLY) Receiver Logic Board (All other models)	045DCT125 45DCT
10 Line Cord (Models manufactured before October 2012) Line Cord (Models manufactured after October 2012)	41B135-1 41B4245-1
11a Filter Board with Screws (Models manufactured before October 2012)	41B7611
11b Terminal Block (Models manufactured after October 2012)	41A3150
12 Travel Module	41A7114-7
<b>Not Shown</b>	
Wire Harness with Screws (Models manufactured before October 2012)	41B7418
Wire Harness with Screws (Models manufactured after October 2012)	041B7610-1



## Free Manuals Download Website

<http://myh66.com>

<http://usermanuals.us>

<http://www.somanuals.com>

<http://www.4manuals.cc>

<http://www.manual-lib.com>

<http://www.404manual.com>

<http://www.luxmanual.com>

<http://aubethermostatmanual.com>

Golf course search by state

<http://golfingnear.com>

Email search by domain

<http://emailbydomain.com>

Auto manuals search

<http://auto.somanuals.com>

TV manuals search

<http://tv.somanuals.com>