

DCS-2210/2230

Version 1.0

# Full HD PoE Wireless N Cube Network Camera

## User Manual

Business Class Networking

---

# Table of Contents

<b>Product Overview</b> .....	<b>4</b>	Add Media .....	39
Package Contents.....	4	Add Event .....	41
System Requirements .....	4	Add Recording .....	43
<b>Hardware Overview</b> .....	<b>5</b>	SD Card.....	45
Front .....	5	Advanced .....	46
Rear.....	6	Digital Input/Output .....	46
Side .....	7	ICR and IR.....	47
<b>Configuration</b> .....	<b>8</b>	HTTPS.....	48
Configuration with Wizard .....	8	Access List.....	49
Web-based Configuration Utility .....	13	Maintenance .....	50
D-ViewCam Setup Wizard.....	15	Device Management .....	50
Live Video .....	17	Backup and Restore .....	51
Setup.....	19	Firmware Upgrade.....	52
Wizard .....	19	Status .....	53
Internet Connection Setup Wizard.....	19	Device Info .....	53
Motion Detection Setup Wizard.....	22	Logs .....	54
Network Setup.....	24	Help .....	55
Wireless Setup(DCS-2230 only) .....	26	<b>Appendix</b> .....	<b>56</b>
Dynamic DNS .....	27	DI/DO Input Specifications .....	56
Image Setup .....	28	Technical Specifications .....	57
Audio and Video.....	30	Technical Specifications .....	58
Preset.....	32	<b>Contacting Technical Support</b> .....	<b>60</b>
Motion Detection .....	34	<b>Warranty</b> .....	<b>61</b>
Time and Date.....	35	<b>Registration</b> .....	<b>67</b>
Event Setup.....	36		
Application.....	37		
Add Server.....	38		

---

# Preface

D-Link reserves the right to revise this publication and to make changes in the contents hereof without obligation to notify any person or organization of such revisions or changes.

## Manual Revisions

Revision	Date	Description
1.0	October 13, 2011	DCS-2210/2230 Revision A1 with firmware version 1.00

## Trademarks

D-Link and the D-Link logo are trademarks or registered trademarks of D-Link Corporation or its subsidiaries in the United States or other countries. All other company or product names mentioned herein are trademarks or registered trademarks of their respective companies.

Copyright © 2011 D-Link Corporation.

All rights reserved. This publication may not be reproduced, in whole or in part, without prior expressed written permission from D-Link Systems, Inc.

# Package Contents



DCS-2210 or DCS-2230 Full HD PoE/Wireless N Cube Network Camera



Camera stand



CAT5 Ethernet cable



Power adapter



CD-ROM with User Manual and software



Quick Installation Guide

If any of the above items are missing, please contact your reseller.

# System Requirements

- Existing 10/100 Ethernet-based network or 802.11 n/g wireless network(Wireless for DCS-2230 )
- Computer with Windows 7/Vista/XP for Camera Setup Wizard
- Internet Explorer, Firefox, Opera, or other web browser for web interface (Internet Explorer recommended for full functionality)

If any of the above items are missing, please contact your reseller.

# Hardware Overview

## Front

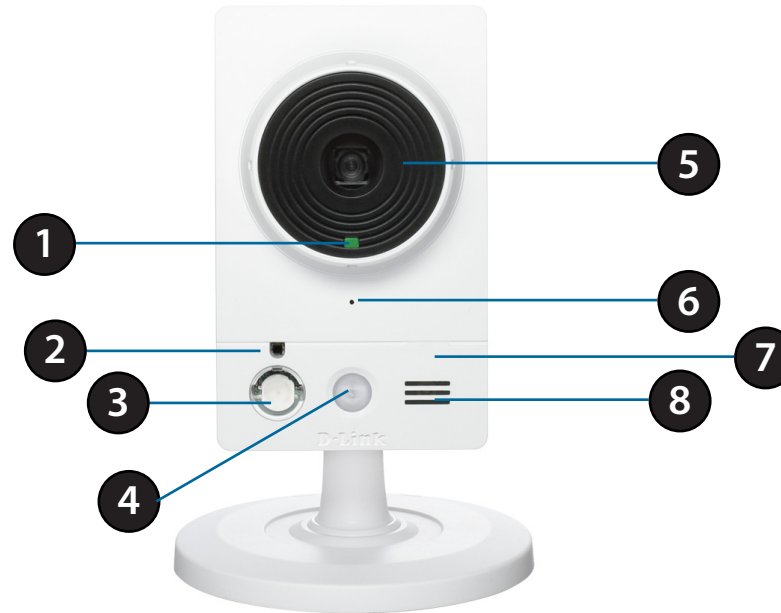

1	<b>Status LED</b>	Indicates the camera's current status
2	<b>ICR Sensor</b>	The IR-Cut Removable sensor monitors lighting conditions and switches between color and infrared accordingly
3	<b>Infrared LED</b>	Used to illuminate the camera's field of view at night
4	<b>PIR</b>	Passive Infrared sensor for motion detect
5	<b>Camera Lens</b>	Records video of the surrounding area
6	<b>Microphone</b>	Records audio from the surrounding area
7	<b>WPS LED (DCS2230 only)</b>	WPS status indicator LED
8	<b>Speaker</b>	Audio output

## Rear

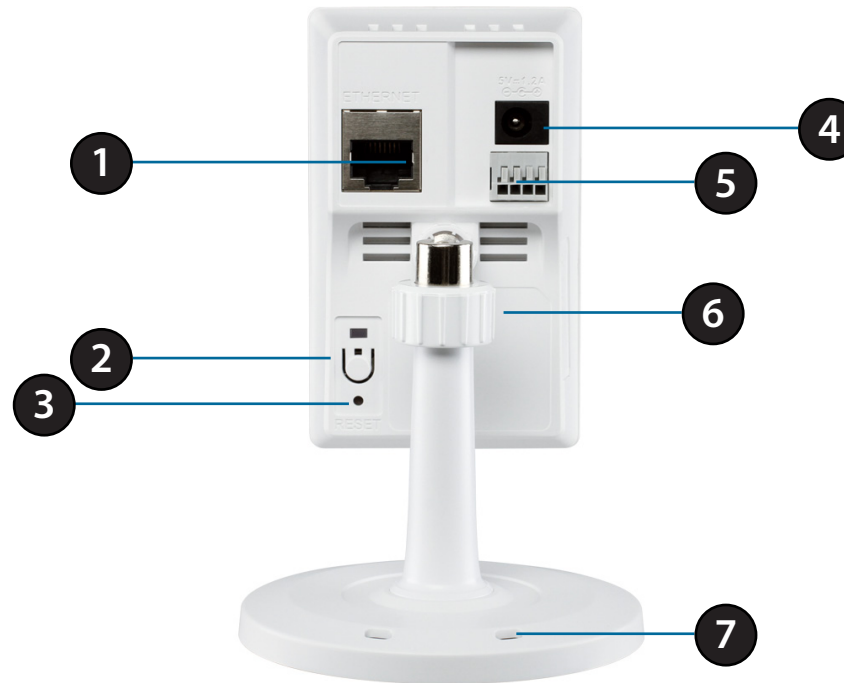

1	<b>Ethernet</b>	RJ45 connector for Ethernet (DCS-2210 support PoE which can also be used to power the camera)
2	<b>WPS Button (DCS-2230 only)</b>	Press this button, then press the WPS button on your router to set up a wireless connection automatically
3	<b>Reset</b>	Press and hold this button for 10 seconds to reset the camera
4	<b>Power Connector</b>	Connects to the included DC 5 V power adapter
5	<b>I/O Connector</b>	I/O connectors for external devices
6	<b>Adjustment Ring</b>	Tighten or loosen the adjustment ring to adjust the camera's position
7	<b>WPS LED (DCS2230 only)</b>	Can be used with cable ties to attach camera to a surface

## Side

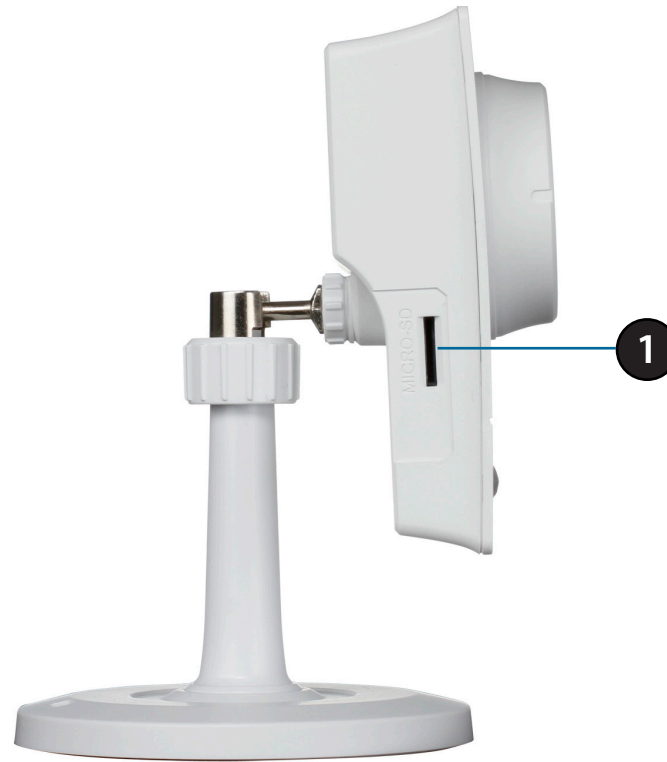

1	<b>Micro SD Card Slot</b>	Local storage for storing recorded image and video
---	---------------------------	--

# Configuration with Wizard

Insert the DCS-2210/DCS-2230 CD into your computer's CD-ROM drive to begin the installation. If the Autorun function on your computer is disabled, or if the D-Link Launcher fails to start automatically, click **Start > Run**. Type **D:\autorun.exe**, where D: represents the drive letter of your CD-ROM drive.

Click **Installation Wizard** to begin the installation.

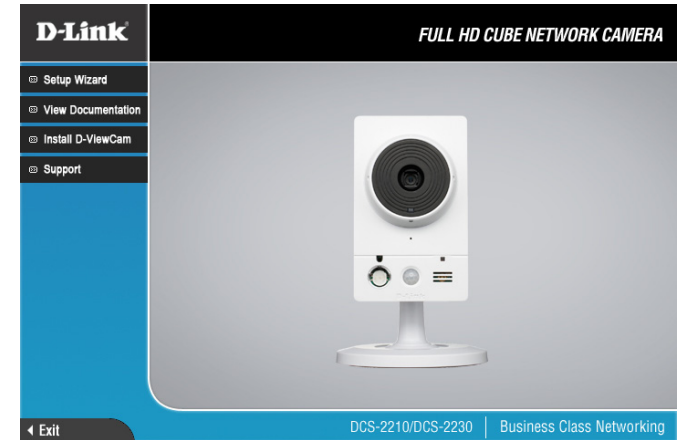

After clicking Setup Wizard, the window on the right will open.

Click **Next** to continue.

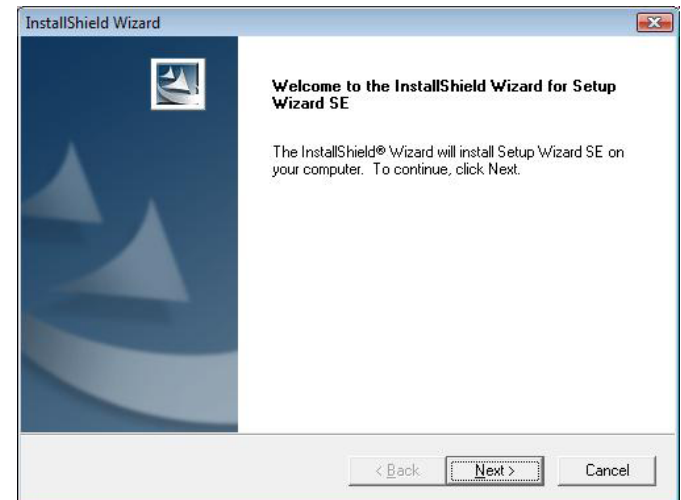



Click **Yes** to accept the License Agreement.

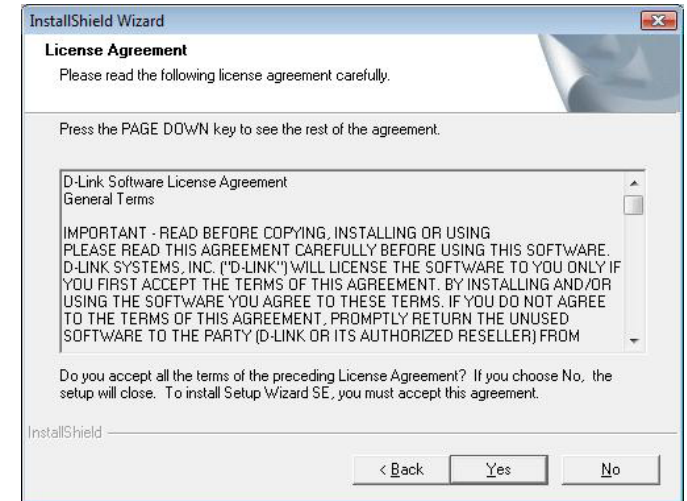

To start the installation process, click **Next**.

**Note:** The installation may take several minutes to finish.

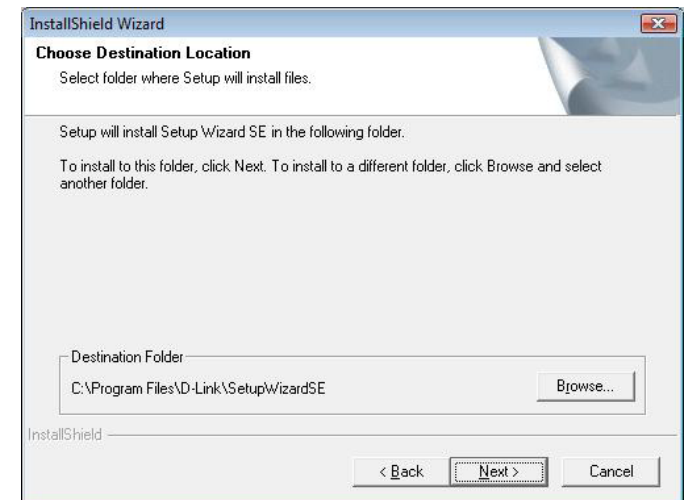

Click **Finish** to complete the installation.

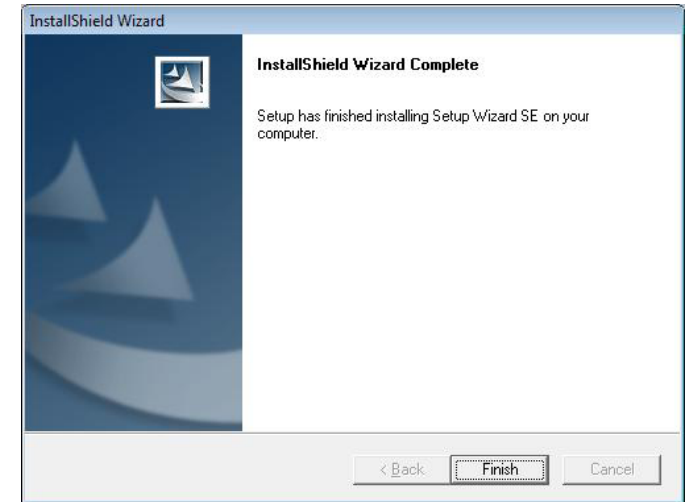

Click on the **D-Link Setup Wizard SE** icon that was created in your Windows Start menu.

**Start > D-Link > Setup Wizard SE**

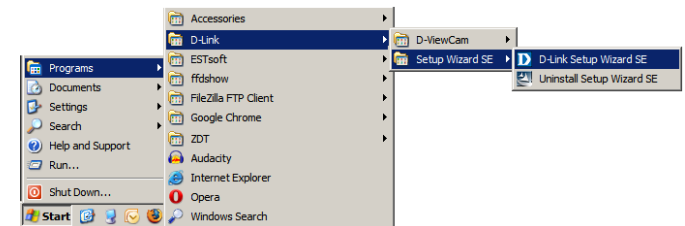

## Configuration

The Setup Wizard will appear and display the MAC address and IP address of your camera(s). If you have a DHCP server on your network, a valid IP Address will be displayed. If your network does not use a DHCP server, the network camera's default static IP address **192.168.0.20** will be displayed.

Click the **Wizard** button to continue.

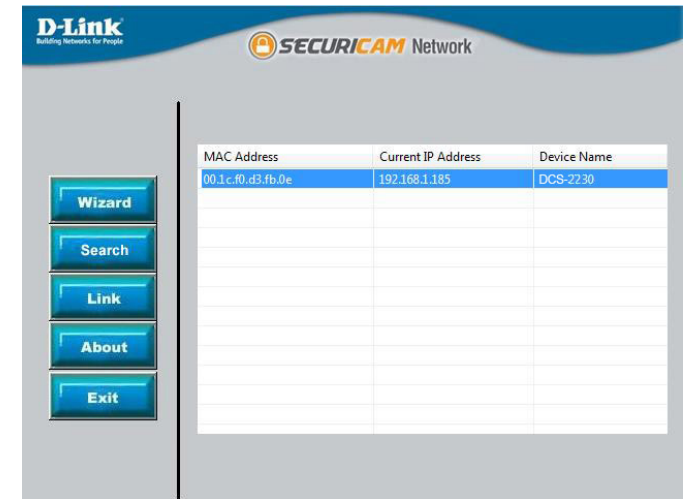

Enter the Admin ID and password. When logging in for the first time, the default Admin ID is **admin** with the password left blank.

Click **Next**, to proceed to the next page.



## Configuration

Select DHCP if your camera obtains an IP address automatically when it boots up. Select static IP if the camera will use the same IP address each time it is started.

Click **Next**, to proceed to the next page.

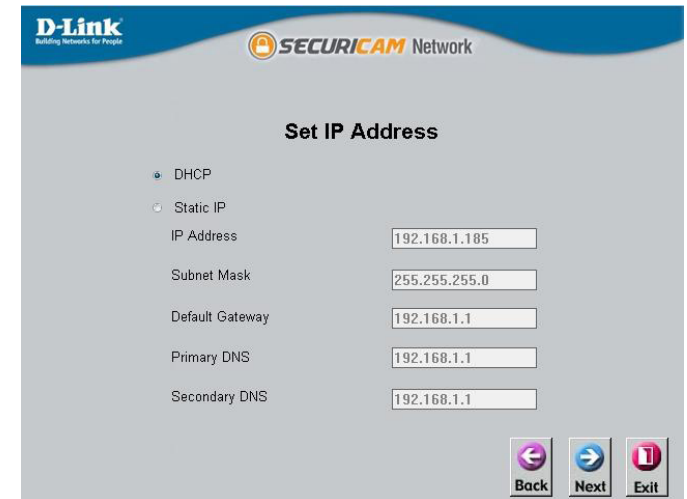

The screenshot shows the 'Set IP Address' configuration screen in the D-Link SECURICAM Network setup wizard. The 'DHCP' option is selected with a radio button. Below it, the 'Static IP' option is also present but unselected. The static IP configuration fields are filled with the following values: IP Address (192.168.1.185), Subnet Mask (255.255.255.0), Default Gateway (192.168.1.1), Primary DNS (192.168.1.1), and Secondary DNS (192.168.1.1). At the bottom right, there are three buttons: 'Back' (left arrow), 'Next' (right arrow), and 'Exit' (power icon).

Take a moment to confirm your settings and click **Restart**.



The screenshot shows the completion screen of the D-Link SECURICAM Network setup wizard. The 'Admin ID' field is filled with 'admin'. The 'Password' field is empty. The other fields (IP Address, Subnet Mask, Primary DNS, Secondary DNS) contain the same values as in the previous screen. Below the fields, a message reads: 'The Setup Wizard has completed. Click on 'Back' to modify your settings. Click 'Restart' to save your current settings and reboot the Internet Camera.' At the bottom right, there are two buttons: 'Back' (left arrow) and 'Restart' (refresh icon).

# Web-based Configuration Utility

This section explains how to configure your new D-Link Network Camera using the Web-based Configuration Utility.

Click on the **D-Link Setup Wizard SE** icon that was created in your Windows Start menu.

**Start > D-Link > Setup Wizard SE**

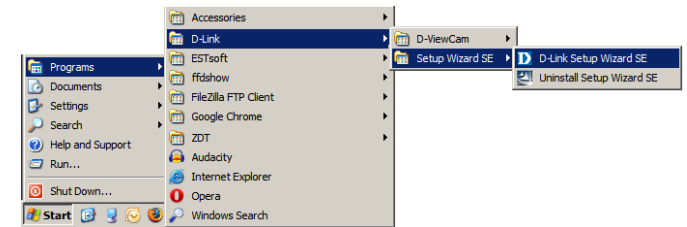

Select the camera and click the button labeled **"Link"** to access the web configuration.

The Setup Wizard will automatically open your web browser to the IP address of the camera.



Alternatively, you may manually open a browser and enter the IP address of the camera: **192.168.0.20**

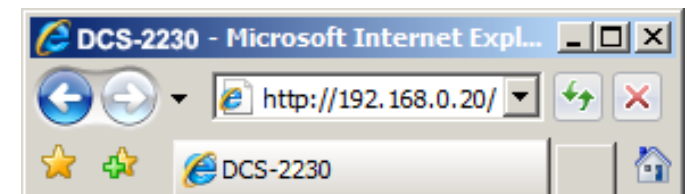

## Configuration

Enter **admin** as the default username and leave the password blank.

Click **OK** to continue.

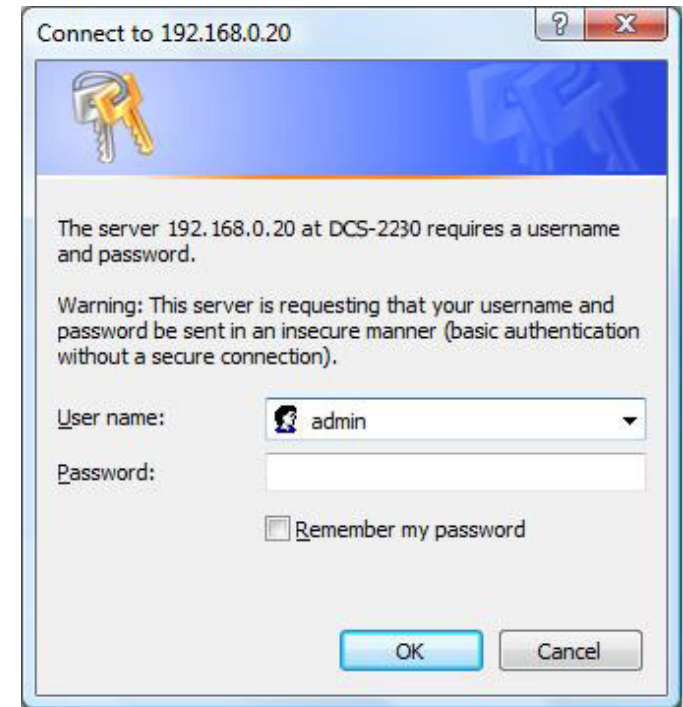

This section shows your camera's live video. You can select your video profile and view or operate the camera. For additional information about web configuration, please refer to the user manual included on the CD-ROM or the D-Link website.

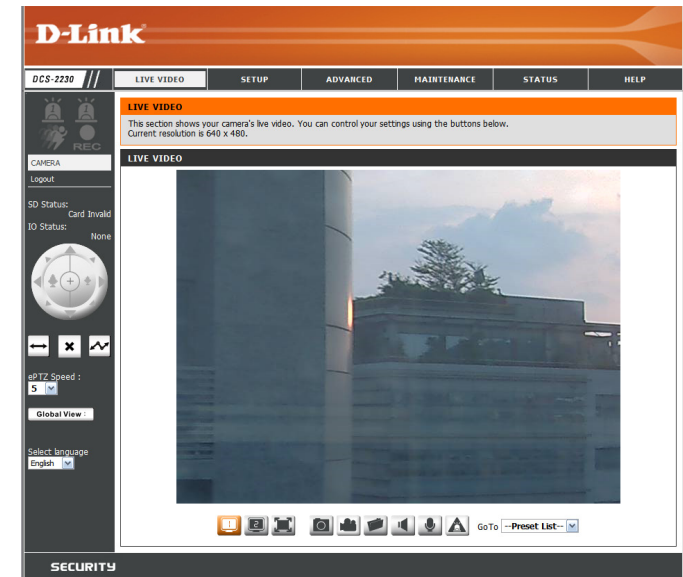

# D-ViewCam Setup Wizard

D-ViewCam software is included for the administrator to manage multiple D-Link IP cameras remotely. You may use the software to configure all the advanced settings for your cameras. D-ViewCam is a comprehensive management tool for IP surveillance.

Insert the CD-ROM into the CD-ROM drive. Click "**Install D-ViewCam Software**" from the menu, and select "**D-ViewCam**" to install the VMS software.



Follow the Installation Wizard to install D-ViewCam.

Click **Next** to continue.

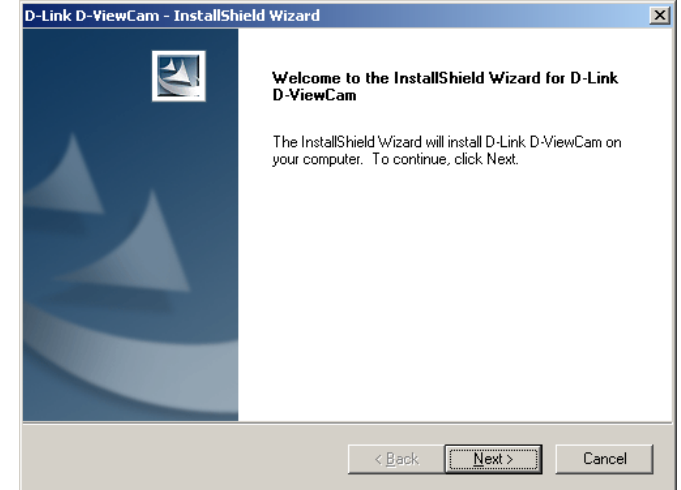

Click **Finish** to complete the installation.

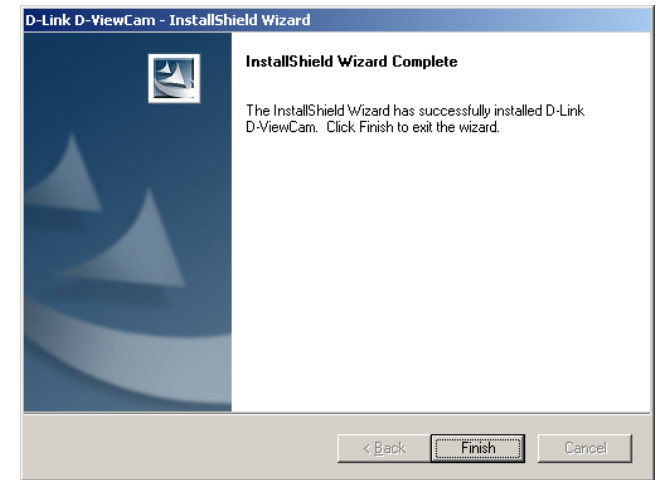

To start the D-ViewCam, select **Start > All Programs > D-Link D-ViewCam > Main Console**.

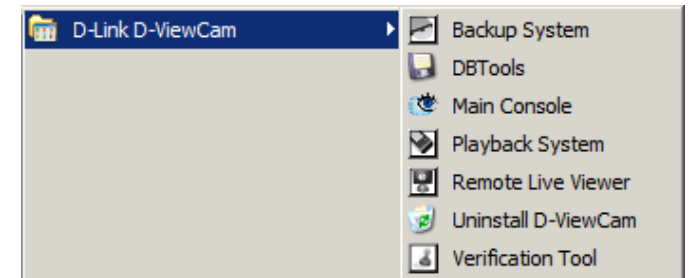

For more detail operation of using D-ViewCam software, please refer to D-ViewCam Manual.

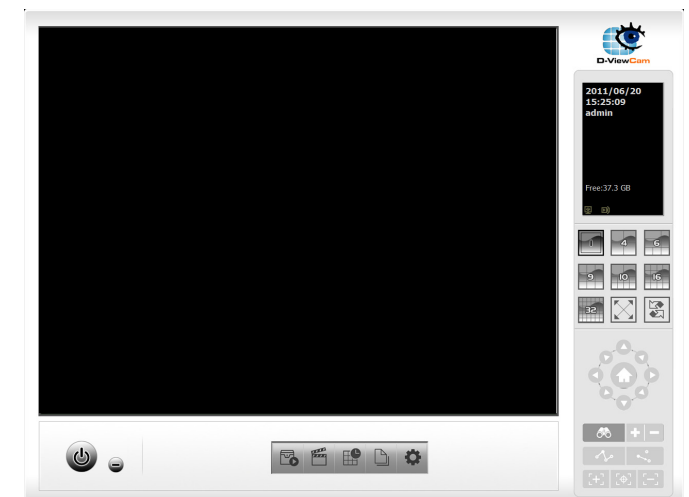















# Live Video

This section shows your camera's live video. You may select any of the available icons listed below to operate the camera. You may also select your language using the drop-down menu on the left side of the screen.

You can zoom in and out on the live video image using your mouse. Right-click to zoom out or left-click to zoom in on the image.

	<b>Digital Input Indicator</b>	This indicator will change color when a digital input signal is detected.
	<b>Motion Trigger Indicator</b>	This indicator will change color when a trigger event occurs.  <b>Note:</b> The video motion feature for your camera must be enabled.
	<b>Recording Indicator</b>	When a recording is in progress, this indicator will change color.



-  Video Profile 1
-  Video Profile 2
-  Video Profile 3
-  Full screen mode
-  Taking a Snapshot
-  Recording a Video Clip
-  Set a Storage Folder
-  Listen/Stop Listening
-  Talk/Stop Talking
-  Start/Stop Digital Output

	<b>Control Pad</b>	This control pad can be used to electronically pan, tilt, and zoom within the camera's predefined view area, if one has been defined.
---	--------------------	---

**Go To:** If any presets have been defined, selecting a preset from this list will display it.

**SD Status:** This option displays the status of the SD card. If no SD card has been inserted, this screen will display the message "Card Invalid."

**IO Status:** This option displays the status of your I/O device if a device has been connected.

**PTZ Control:** This camera uses electronic pan/tilt/zoom (ePTZ) to select and view areas of interest in the field of view. Please see page 30 for information about setting the frame size and view window area.

**ePTZ Speed:** You may select a value between 0 and 64. 0 is the slowest and 64 is the fastest.

**Global View:** This window indicates the total field of view (FOV) of the camera. The red box indicates the visible region of interest (ROI).

**Language:** You may select the interface language using this menu.

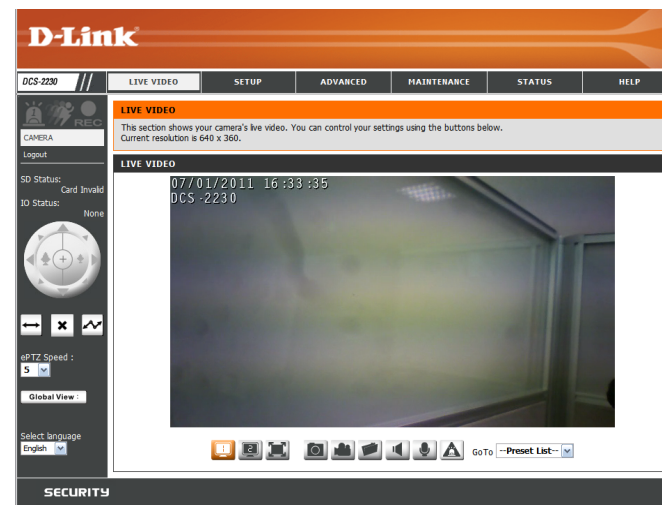

	<b>Auto Pan</b>	Starts the automatic panning function. The ROI will pan from back and forth within the FOV
	<b>Stop</b>	Stops the camera ePTZ motion
	<b>Preset Path</b>	Starts the camera's motion along the predefined path

# Setup Wizard

To configure your Network Camera, click **Internet Connection Setup Wizard**. Alternatively, you may click **Manual Internet Connection Setup** to manually configure your Network Camera and skip to page 26.

To quickly configure your Network Camera's motion detection settings, click **Motion Detection Setup Wizard**. If you want to enter your settings without running the wizard, click **Manual Motion Detection Setup** and skip to page 34.

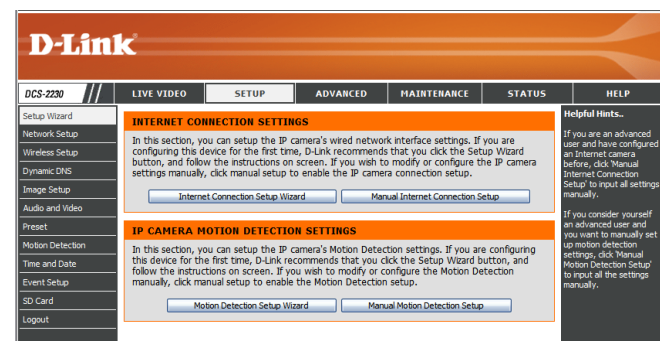

## Internet Connection Setup Wizard

This wizard will guide you through a step-by-step process to configure your new D-Link Camera and connect the camera to the internet. Click **Next** to continue.

**Note:** Select DHCP if you are unsure of which settings to choose.

Click **Next** to continue.

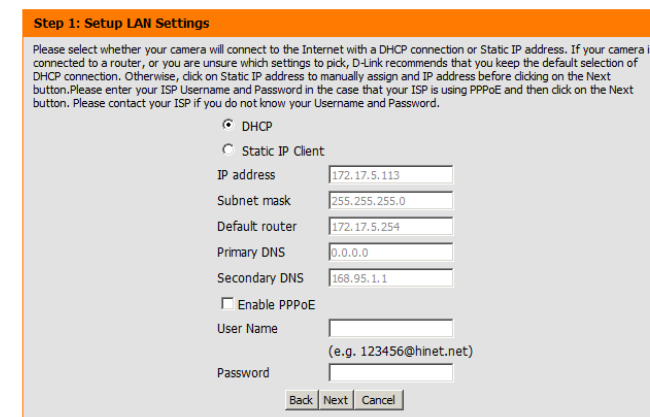
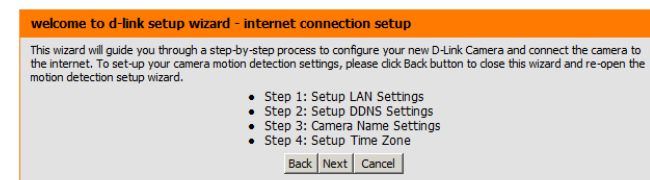

## Configuration

Select **Static IP** if your Internet Service Provider has provided you with connection settings, or if you wish to set a static address within your home network. Enter the correct configuration information and click **Next** to continue.

If you are using PPPoE, select **Enable PPPoE** and enter your user name and password, otherwise click **Next** to continue.

If you have a Dynamic DNS account and would like the camera to update your IP address automatically, Select **Enable DDNS** and enter your host information. Click **Next** to continue.

Enter a name for your camera and click **Next** to continue.

**Step 1: Setup LAN Settings**

Please select whether your camera will connect to the Internet with a DHCP connection or Static IP address. If your camera is connected to a router, or you are unsure which settings to pick, D-Link recommends that you keep the default selection of DHCP connection. Otherwise, click on Static IP address to manually assign and IP address before clicking on the Next button. Please enter your ISP Username and Password in the case that your ISP is using PPPoE and then click on the Next button. Please contact your ISP if you do not know your Username and Password.

DHCP  
 Static IP Client

IP address   
Subnet mask   
Default router   
Primary DNS   
Secondary DNS

Enable PPPoE  
User Name   
(e.g. 123456@hinet.net)  
Password

**Step 2: Setup DDNS Settings**

If you have a Dynamic DNS account and would like the camera to update your IP address automatically, enable DDNS and enter in your host information below. Please click on the Next button to continue.

Enable DDNS

Server Address  <<

Host Name   
User Name   
Password   
Verify Password   
Timeout  (hours)

**Step 3: Camera Name Settings**

D-Link recommends that you rename your camera for easy accessibility. You can then identify and connect to your camera via this name. Please assign a name of your choice before clicking on the Next button.

IP Camera Name

## Configuration

---

Configure the correct time to ensure that all events will be triggered as scheduled. Click **Next** to continue.

If you have selected DHCP, you will see a summary of your settings, including the camera's IP address. Please write down all of this information as you will need it in order to access your camera.

Click **Apply** to save your settings.

**Step 4: Setup Time Zone**

Please configure the correct time to ensure that all events are triggered, captured and scheduled at the correct time and day and then click on the Next button.

Time Zone

Enable Daylight Saving

**Step 5: Setup complete**

Below is a summary of your camera settings. Click on the Back button to review or modify settings or click on the Apply button if all settings are correct. It is recommended to note down these settings in order to access your camera on the network or via your web browser.

IP Address	DHCP
IP Camera Name	DCS-2230
Time Zone	(GMT+08:00) Taipei
DDNS	Disable
PPPoE	Disable

# Motion Detection Setup Wizard

This wizard will guide you through a step-by-step process to configure your camera's motion detection functions.

Click **Next** to continue.

## Step 1

This step will allow you to enable or disable motion detection, specify the detection sensitivity, and adjust the camera's ability to detect movement.

You may specify whether the camera should capture a snapshot or a video clip when motion is detected.

Please see the **Motion Detection** section on page 34 for information about how to configure motion detection.

## Step 2

This step allows you to enable motion detection based on a customized schedule. Specify the day and hours. You may also choose to always record motion.

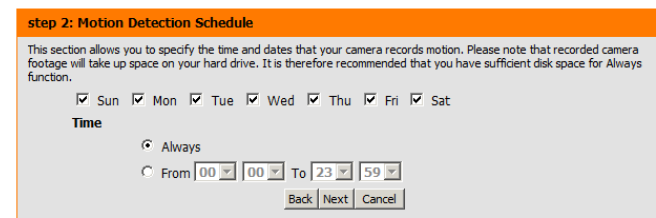
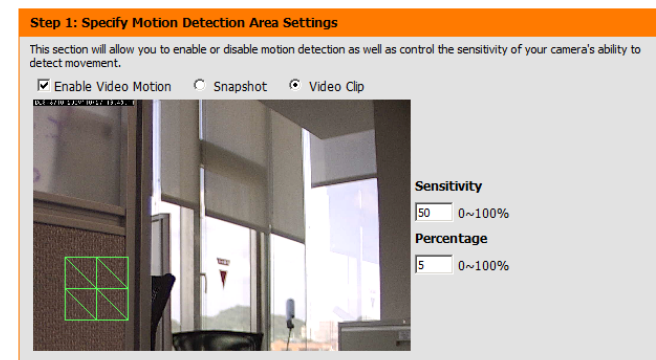
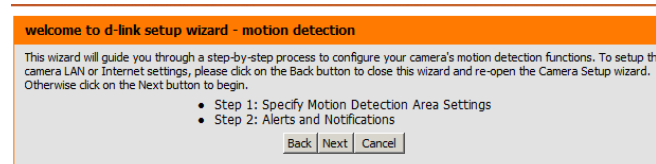

## Step 3

This step allows you to specify how you will receive event notifications from your camera. You may choose not to receive notifications, or to receive notifications via e-mail or FTP.

Please enter the relevant information for your e-mail or FTP account.

Click **Next** to continue.

**Step 3: Alerts and Notification**

This final step allows you to specify how you receive notification of camera events. Choose between an email notification or alternatively you can setup an FTP Notification. You will need your email account settings or FTP details. If you are unsure of this information, please contact your ISP. Once you have entered this information, please click on the Next button.

Do not notify me

Email

Sender email address

Recipient email address

Server address

User name

Password

Port

FTP

Server address

Port

User name

Password

Remote folder name

## Step 4

You have completed the Motion Detection Wizard.

Please verify your settings and click **Apply** to save them.

**Step 4: Setup Complete**

You have completed your camera setup. Please click the Back button if you want to review or modify your settings or click on the Apply button to save and apply your settings.

Motion Detection : Enable

EVENT : Video Clip

Schedule Day : Sun , Mon , Tue , Wed , Thu , Fri , Sat ,

Schedule Time : Always

Alerts and Notification : Email

Please wait a few moments while the camera saves your settings and restarts.

**Step 4: Setup Complete**

You have completed your camera setup. Please click the Back button if you want to review or modify your settings or click on the Apply button to save and apply your settings.

Changes saved.IP Camera's network is restarting, please wait for 3 seconds ...

# Network Setup

Use this section to configure the network connections for your camera. All relevant information must be entered accurately. After making any changes, click the **Save Settings** button to save your changes.

**LAN Settings:** This section lets you configure settings for your local area network.

**DHCP:** Select this connection if you have a DHCP server running on your network and would like your camera to obtain an IP address automatically.

**Static IP Address:** You may obtain a static or fixed IP address and other network information from your network administrator for your camera. A static IP address may simplify access to your camera in the future.

**IP Address:** Enter the fixed IP address in this field.

**Subnet Mask:** This number is used to determine if the destination is in the same subnet. The default value is 255.255.255.0.

**Default Gateway:** The gateway used to forward frames to destinations in a different subnet. Invalid gateway settings may cause the failure of transmissions to a different subnet.

**Primary DNS:** The primary domain name server translates names to IP addresses.

**Secondary DNS:** The secondary DNS acts as a backup to the primary DNS.

**Enable UPnP:** Enabling this setting allows your camera to be configured as a UPnP device on your network.

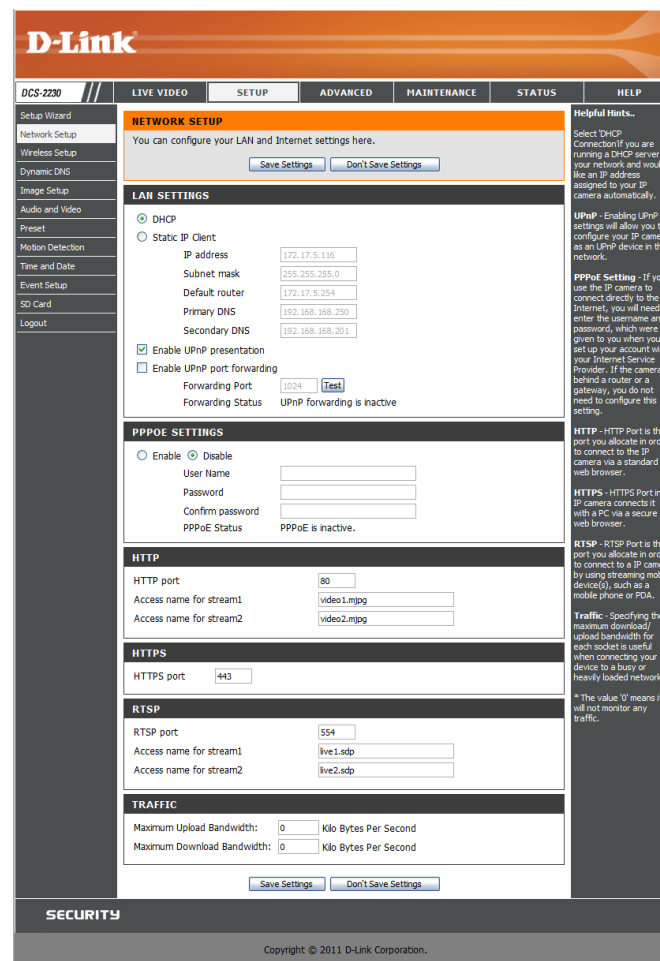



**Enable UPnP Port Forwarding:** Enabling this setting allows the camera to add port forwarding entries into the router automatically on a UPnP capable network.

**Enable PPPoE:** Enable this setting if your network uses PPPoE.

**User Name / Password:** Enter the username and password for your PPPoE account. Re-enter your password in the Confirm Password field. You may obtain this information from your ISP.

**HTTP Port:** The default port number is 80.

**Access Name for Stream 1~3:** The default name is video#.mjpg, where # is the number of the stream.

**HTTPS Port:** You may use a PC with a secure browser to connect to the HTTPS port of the camera. The default port number is 443.

**RTSP Port:** The port number that you use for RTSP streaming to mobile devices, such as mobile phones or PDAs. The default port number is 554. You may specify the address of a particular stream. For instance, live1.sdp can be accessed at `rtsp://x.x.x.x/video1.sdp` where the x.x.x.x represents the ip address of your camera.

**Maximum Upload/Download Bandwidth:** Specifying the maximum download/upload bandwidth for each socket can be useful when connecting your device to a busy or heavily loaded network. Entering a value of '0' indicates that the camera should not monitor bandwidth. Specifying other values will limit the camera's transfer speed to the specified number of kilobytes per second.

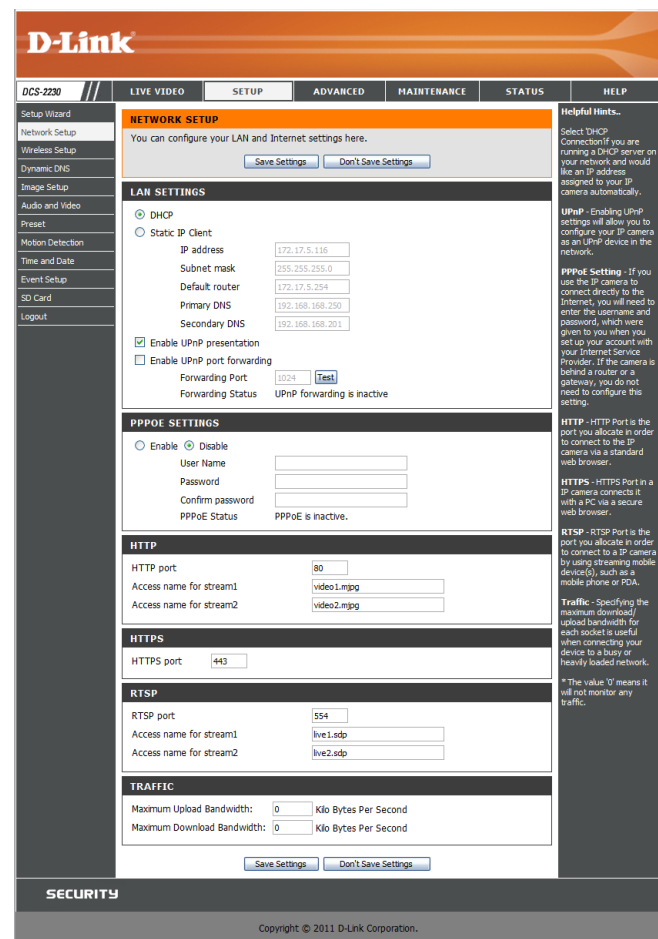

## Wireless Setup(DCS-2230 only)

This section allows you to set up and configure the wireless settings on your camera. After making any changes, click the **Save Settings** button to save your changes.

**Site Survey:** Click the **Rescan** button to scan for available wireless networks. After scanning, you can use the drop-down box to select an available wireless network. The related information (SSID, Wireless Mode, Channel, Authentication, Encryption) will be automatically filled in for you.

**SSID:** Enter the SSID of the wireless access point you wish to use.

**Wireless Mode:** Use the drop-down box to select the mode of the wireless network you wish to connect to. Infrastructure is normally used to connect to an access point or router. Ad-Hoc is usually used to connect directly to another computer.

**Channel:** If you are using Ad Hoc mode, select the channel of the wireless network you wish to connect to, or select Auto.

**Authentication:** Select the authentication you use on your wireless network - Open, Shared, WPA-PSK, or WPA2-PSK.

**Encryption:** If you use WPA-PSK or WPA2-PSK authentication, you will need to specify whether your wireless network uses TKIP or AES encryption. If you use Open or Shared authentication, WEP encryption should be the setting.

**Key:** If you use WEP, WPA-PSK, or WPA2-PSK authentication, enter the Key (also known as password) used for your wireless network.

The screenshot shows the D-Link web interface for the DCS-2230 camera. The main navigation bar includes 'LIVE VIDEO', 'SETUP', 'ADVANCED', 'MAINTENANCE', 'STATUS', and 'HELP'. The 'SETUP' tab is active, and the 'WIRELESS SETUP' sub-tab is selected. The page title is 'WIRELESS SETUP'. Below the title, there is a 'Rescan' button and a 'Save Settings' button. The 'WIRELESS CONFIGURATION' section contains the following fields:

- Enable Wireless:
- Site Survey:
- SSID:
- Wireless Mode:
- Channel:
- Authentication:
- Encryption:
- Default Key:
- Key 1:
- Key 2:
- Key 3:
- Key 4:

At the bottom of the configuration section, there are 'Save Settings' and 'Don't Save Settings' buttons. On the right side of the page, there is a 'Helpful Hints...' section with text explaining the SSID, Authentication, Shared, and WPA-PSK/WPA2-PSK options.

# Dynamic DNS

DDNS (Dynamic Domain Name Server) will hold a DNS host name and synchronize the public IP address of the modem when it has been modified. A user name and password are required when using the DDNS service. After making any changes, click the **Save Settings** button to save your changes.

**Enable DDNS:** Select this checkbox to enable the DDNS function.

**Server Address:** Select your Dynamic DNS provider from the pull down menu or enter the server address manually.

**Host Name:** Enter the host name of the DDNS server.

**User Name:** Enter the user name or e-mail used to connect to your DDNS account.

**Password:** Enter the password used to connect to your DDNS server account.

**Timeout:** Enter the DNS Timeout values you wish to use.

**Status:** Indicates the connection status, which is automatically determined by the system.

The screenshot shows the D-Link web interface for configuring Dynamic DNS. The page is titled "DYNAMIC DNS" and includes a "Helpful Hints..." section on the right. The main configuration area is titled "DYNAMIC DNS SETTING" and contains the following fields:

- Enable DDNS:** A checkbox that is checked.
- Server Address:** A text input field containing "www.dlinkddns.com" and a dropdown menu showing "www.dlinkddns.com" selected.
- Host Name:** A text input field.
- User Name:** A text input field.
- Password:** A text input field.
- Verify Password:** A text input field.
- Timeout:** A text input field containing "24" and "(hours)".
- Status:** A dropdown menu showing "Active".

Buttons for "Save Settings" and "Don't Save Settings" are located at the bottom of the configuration area.

# Image Setup

In this section, you may configure the video image settings for your camera. A preview of the image will be shown in Live Video.

**Enable Privacy Mask:** The Privacy Mask setting allows you to specify up to 3 rectangular areas on the camera's image to be blocked/excluded from recordings and snapshots.

You may click and drag the mouse cursor over the camera image to draw a mask area. Right clicking on the camera image brings up the following menu options:

**Disable All:** Disables all mask areas

**Enable All:** Enables all mask areas

**Reset All:** Clears all mask areas.

**Anti Flicker:** If the video flickers, try enabling this setting.

**Mirror:** This will mirror the image horizontally.

**Flip:** This will flip the image vertically. When turning Flip on, you may want to consider turning Mirror on as well.

**Power Line:** Select the frequency used by your power lines to avoid interference or distortion.

**White Balance:** Use the drop-down box to change white balance settings to help balance colors for different environments. You can choose from Auto, Outdoor, Indoor, Fluorescent, and Push Hold.

**Exposure Mode:** Changes the exposure mode. Use the drop-down box to set the camera for Indoor, Outdoor, or Night environments, or to Moving to capture moving objects. The Low Noise option will focus on creating a high-quality picture without noise. You can also create 3 different custom exposure modes. The Max Gain setting will allow you to control the maximum amount of gain to apply to brighten the picture.

**Denoise:** This setting controls the amount of noise reduction that will be applied to the picture.

**Brightness:** Adjust this setting to compensate for backlit subjects.



**Contrast:** Adjust this setting to alter the color intensity/strength.

**Saturation:** This setting controls the amount of coloration, from grayscale to fully saturated.

**Sharpness:** Specify a value from 0 to 8 to specify how much sharpening to apply to the image.

**Reset Default:** Click this button to reset the image to factory default settings.

# Audio and Video

You may configure up to 3 video profiles with different settings for your camera. Hence, you may set up different profiles for your computer and mobile display. In addition, you may also configure the two-way audio settings for your camera. After making any changes, click the **Save Settings** button to save your changes.

**Number of active profiles:** You can use the drop-down box to set up to 3 active profiles.

**Aspect ratio:** Set the aspect ratio of the video to 4:3 standard or 16:9 widescreen.

**Mode:** Set the video codec to be used to JPEG, MPEG-4, or H.264.

**Frame size / View window area:** Frame size determines the total capture resolution, and View window area determines the Live Video viewing window size. If the Frame size is larger than the Live Video size, you can use the ePTZ controls to look around.

16:9	1920x1080,	1280x720,	800x450,
	640x360,	480x270,	320x176,
	176x144		
4:3	1024x768,	800x600,	640x480,
	480x 360,	320x240,	176x144

**Note:** If your View window area is the same as your Frame size, you will not be able to use the ePTZ function.

**Maximum frame rate:** A higher frame rate provides smoother motion for videos, and requires more bandwidth. Lower frame rates will result in stuttering motion, and requires less bandwidth.

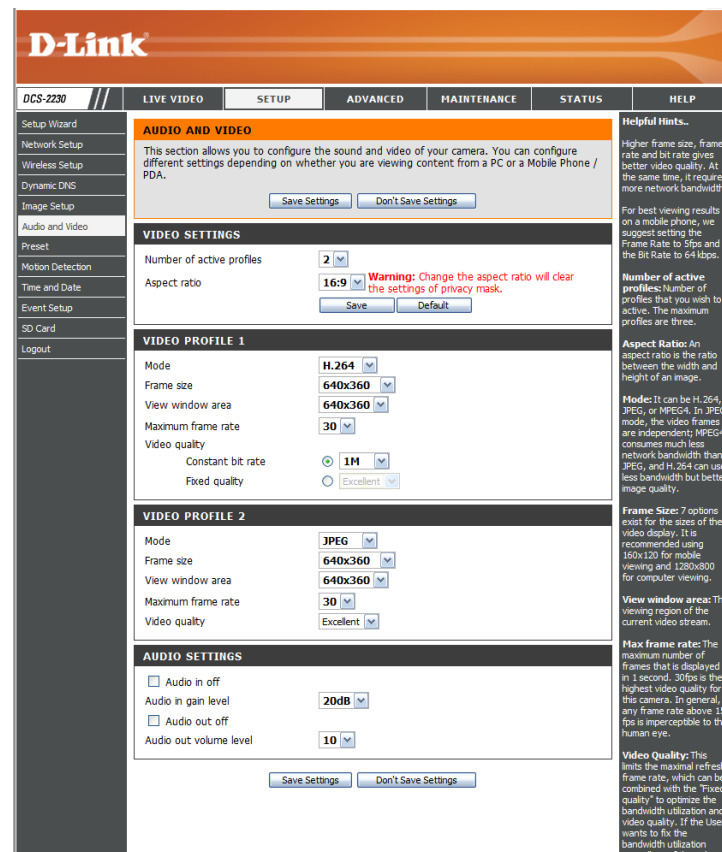

**Video Quality:** This limits the maximum frame rate, which can be combined with the "Fixed quality" option to optimize the bandwidth utilization and video quality. If fixed bandwidth utilization is desired regardless of the video quality, choose "Constant bit rate" and select the desired bandwidth.

**Constant bit rate:** The bps will affect the bit rate of the video recorded by the camera. Higher bit rates result in higher video quality.

**Fixed quality:** Select the image quality level for the camera to try to maintain. High quality levels will result in increased bit rates.

**Audio in off:** Selecting this checkbox will mute incoming audio.

**Audio in gain level:** This setting controls the amount of gain applied to incoming audio to increase its volume.

**Audio out off:** Selecting this checkbox will mute outgoing audio.

**Audio out volume level:** This setting controls the amount of gain applied to outgoing audio to increase its volume.

The screenshot shows the D-Link configuration web interface for the DCS-2230 camera. The page is titled "AUDIO AND VIDEO" and contains several sections for configuring the camera's audio and video output.

- Header:** D-Link logo and navigation tabs: LIVE VIDEO, SETUP, ADVANCED, MAINTENANCE, STATUS, HELP.
- Left Sidebar:** Setup Wizard, Network Setup, Wireless Setup, Dynamic DNS, Image Setup, Audio and Video (selected), Preset, Motion Detection, Time and Date, Event Setup, SD Card, Logout.
- Main Content Area:**
  - AUDIO AND VIDEO:** Introduction text and "Save Settings" / "Don't Save Settings" buttons.
  - VIDEO SETTINGS:**
    - Number of active profiles: 2
    - Aspect ratio: 16:9 (Warning: Change the aspect ratio will clear the settings of privacy mask.)
  - VIDEO PROFILE 1:**
    - Mode: H.264
    - Frame size: 640x360
    - View window area: 640x360
    - Maximum frame rate: 30
    - Video quality: Constant bit rate (selected), 1M, Excellent
  - VIDEO PROFILE 2:**
    - Mode: JPEG
    - Frame size: 640x360
    - View window area: 640x360
    - Maximum frame rate: 30
    - Video quality: Excellent
  - AUDIO SETTINGS:**
    - Audio in off:
    - Audio in gain level: 20dB
    - Audio out off:
    - Audio out volume level: 10
- Right Sidebar (Helpful Hints):**
  - Higher frame size, frame rate and bit rate gives better video quality. At the same time, it requires more network bandwidth.
  - For best viewing results on a mobile phone, we suggest setting the Frame Rate to 5fps and the Bit Rate to 64 kbps.
  - Number of active profiles: Number of profiles that you wish to activate. The maximum profiles are three.
  - Aspect Ratio: An aspect ratio is the ratio between the width and height of an image.
  - Mode: It can be H.264, JPEG, or MPEG4. In JPEG mode, the video frames are independent. MPEG4 consumes much less network bandwidth than JPEG, and H.264 can use less bandwidth but better image quality.
  - Frame Size: 7 options exist for the sizes of the video display. It is recommended using 160x120 for mobile viewing and 1280x800 for computer viewing.
  - View window area: The viewing region of the current video stream.
  - Max frame rates: The maximum number of frames that is displayed in 1 second. 30fps is the highest video quality for this camera. In general, any frame rate above 15 fps is imperceptible to the human eye.
  - Video Quality: This limits the maximal refresh frame rate, which can be combined with the "Fixed quality" to optimize the bandwidth utilization and video quality. If the User wants to fix the bandwidth utilization regardless of the video quality, choose "Constant bit rate" and select the desired bandwidth.

# Preset

This screen allows you to set preset points for the ePTZ function of the camera, which allows you to look around the camera's viewable area by using a zoomed view. Presets allow you to quickly go to and view a specific part of the area your camera is covering, and you can create preset sequences, which will automatically change the camera's view between the different presets according to a defined order and timing you can set.

**Note:** If your View window area is the same as your Frame size, you will not be able to use the ePTZ function. For more details, refer to "Audio and Video" on page 30.

**Video Profile:** This selects which video profile to use. For more information, refer to "Audio and Video" on page 30.

**ePTZ Speed:** You may select a value between 0 and 64. 0 is the slowest and 64 is the fastest.

**Arrow Buttons and Home Button:** Use these buttons to move to a specific part of the viewing area, which you can then set as a preset. Click the Home button to return to the center of the viewing area.

**Input Preset Name:** Enter the name of the preset you want to create, then click the **Add** button to make a new preset. If an existing preset has been selected from the Preset List, you can change its name by typing in a new name, then clicking the **Rename** button.

**Preset List:** Click this drop-down box to see a list of all the presets that have been created. You can select one, then click the **GoTo** button to change the displayed camera view to the preset. Clicking the **Remove** button will delete the currently selected preset.





**Preset Sequence:** This section allows you to create a preset sequence, which automatically moves the camera's view between a set of preset views.

**Preset List:** To add a preset to the sequence, select it from the drop-down box at the bottom of this window, set the **Dwell time** to determine how long the camera view will stay at that preset, then click the **Add** button. The preset name will appear in the list, followed by the dwell time to view that preset for.

You can rearrange your presets in the sequence by selecting a preset in the sequence, then clicking the arrow buttons to move it higher or lower in the current sequence.

Clicking the trash can button will remove the currently selected preset from the sequence.

If you want to change the dwell time for a preset, select it from the list, enter a new dwell time, then click the **Update** button.

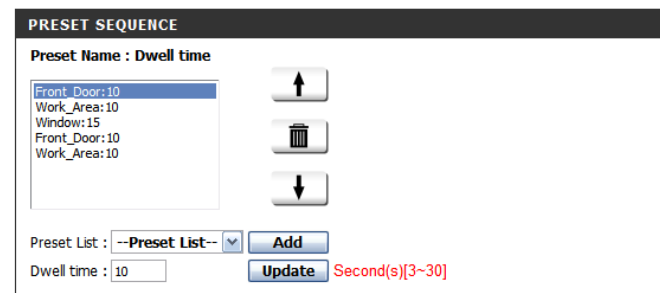

The screenshot shows a configuration window titled "PRESET SEQUENCE". At the top, it says "Preset Name : Dwell time". Below this is a list of presets: "Front\_Door:10", "Work\_Area:10", "Window:15", "Front\_Door:10", and "Work\_Area:10". To the right of the list are three buttons: an up arrow, a trash can, and a down arrow. Below the list is a "Preset List" dropdown menu showing "--Preset List--" and an "Add" button. Below that is a "Dwell time" input field with the value "10" and an "Update" button. To the right of the "Update" button is a red label "Second(s)[3~30]".

# Motion Detection

Enabling Video Motion will allow your camera to use the motion detection feature. You may draw a finite motion area that will be used for monitoring. After making any changes, click the **Save Settings** button to save your changes.

**Enable Video Motion:** Select this box to enable the motion detection feature of your camera.

**Sensitivity:** Specifies the measurable difference between two sequential images that would indicate motion. Please enter a value between 0 and 100.

**Percentage:** Specifies the amount of motion in the window being monitored that is required to initiate an alert. If this is set to 100%, motion is detected within the whole window will trigger a snapshot.

**Draw Motion Area:** Draw the motion detection area by dragging your mouse in the window (indicated by the red square).

**Erase Motion Area:** To erase a motion detection area, simply click on the red square that you wish to remove.

Right clicking on the camera image brings up the following menu options:

**Select All:** Draws a motion detection area over the entire screen.

**Clear All:** Clears any motion detection areas that have been drawn.

**Restore:** Restores the previously specified motion detection areas.

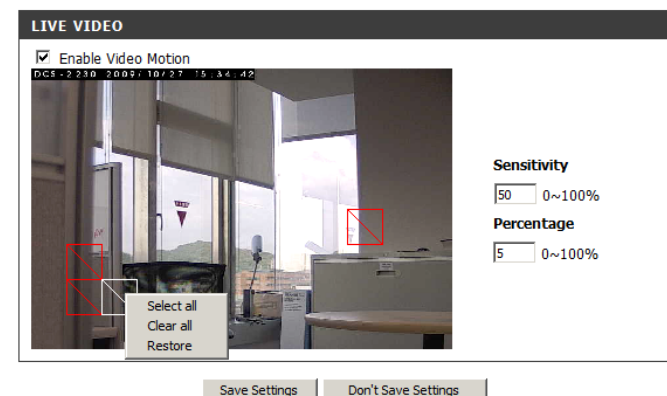
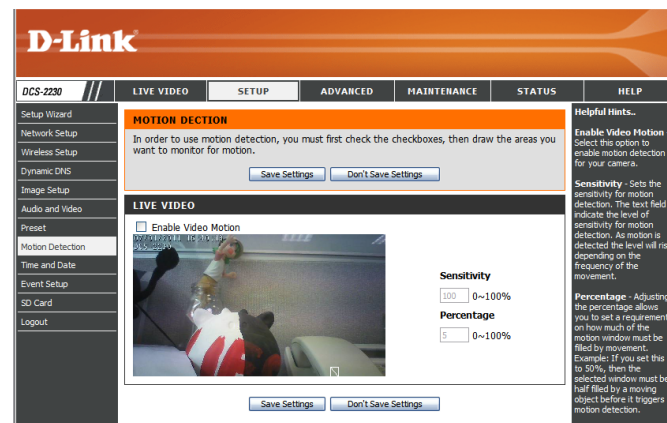

# Time and Date

This section allows you to automatically or manually configure, update, and maintain the internal system clock for your camera. After making any changes, click the **Save Settings** button to save your changes.

**Time Zone:** Select your time zone from the drop-down menu.

**Enable Daylight Saving:** Select this to enable Daylight Saving Time.

**Auto Daylight Saving:** Select this option to allow your camera to configure the Daylight Saving settings automatically.

**Set Date and Time Manually:** Selecting this option allows you to configure the Daylight Saving date and time manually.

**Offset:** Sets the amount of time to be added or removed when Daylight Saving is enabled.

**Synchronize with NTP Server:** Enable this feature to obtain time automatically from an NTP server.

**NTP Server:** Network Time Protocol (NTP) synchronizes the DCS-2230 with an Internet time server. Choose the one that is closest to your location.

**Set the Date and Time Manually:** This option allows you to set the time and date manually.

**Copy Your Computer's Time Settings:** This will synchronize the time information from your PC.

Product: DCS-2230 Firmware Version : 0.10

**D-Link**

DCS-2230 // LIVE VIDEO SETUP ADVANCED MAINTENANCE STATUS HELP

**TIME AND DATE**  
You can set the current time for the IP camera.  
Save Settings Don't Save Settings

**TIME CONFIGURATION**  
Time Zone | (GMT+08:00) Taipei  
 Enable Daylight Saving  
 Auto Daylight Saving  
 Set date and time manually  
Offset: +2:00  
Start time: Month 5, Week 1, Day of week Sunday, Hour 0, Minutes 00  
End time: Month 10, Week 1, Day of week Sunday, Hour 0, Minutes 00

**AUTOMATIC TIME CONFIGURATION**  
 Synchronize with NTP Server  
NTP Server: ntp.dlink.com.tw << Select NTP Server

**SET DATE AND TIME MANUALLY**  
 Set date and time manually  
Year: 2011, Month: 1, Day: 7  
Hour: 16, Minute: 40, Second: 18  
Copy Your Computer's Time Settings  
Save Settings Don't Save Settings

**Helpful Hints...**  
Good timekeeping is important for accurate logs and scheduled firewall rules.  
**Time Zone:** Select your time zone from the drop-down menu.  
**Enable Daylight Saving:** Select this to enable the daylight saving time.  
**Auto Daylight Saving:** When you select to the clock is automatically adjusted according to the daylight saving time of the selected time zone.  
**Offset:** Select the time offset, if your location observes daylight saving time.  
**Synchronize with NTP Server:** With the option selected, the camera will synchronize the time settings with the NTP server over the Internet whenever the camera starts up. If the timeserver cannot be reached, no time settings will be applied.  
**NTP Server:** Network Time Protocol (NTP) synchronizes the IP camera with an Internet time server. Choose the one that is closest to your location.  
**Copy Your Computer's Time**

# Event Setup

The Event Setup page includes 4 different sections.

- Event
- Server
- Media
- Recording

1. To add a new item - "event, server or media," click **Add**. A screen will appear and allow you to update the fields accordingly.
2. To delete the selected item from the pull-down menu of event, server or media, click **Delete**.
3. Click on the item name to pop up a window for modifying.

**Note:** You can add up to four events, five servers, and five media fields.

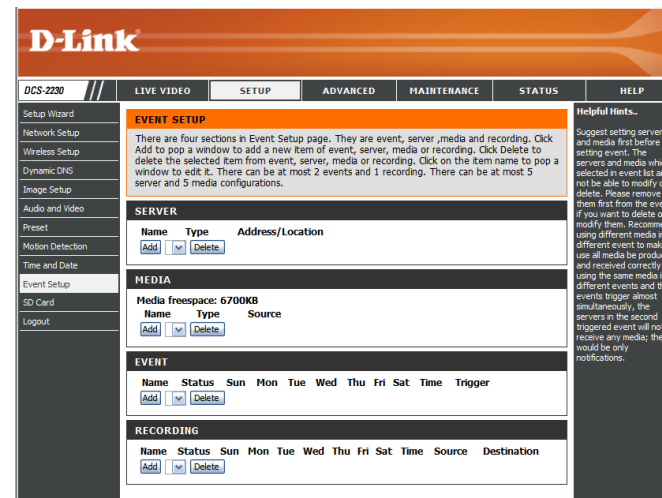

# Application

In a typical application, when motion is detected, the DCS-2230 Network Camera sends images to a FTP server or via e-mail as notifications. As shown in the illustration below, an event can be triggered by many sources, such as motion detection or external digital input devices. When an event is triggered, a specified action will be performed. You can configure the Network Camera to send snapshots or videos to your e-mail address or FTP site.

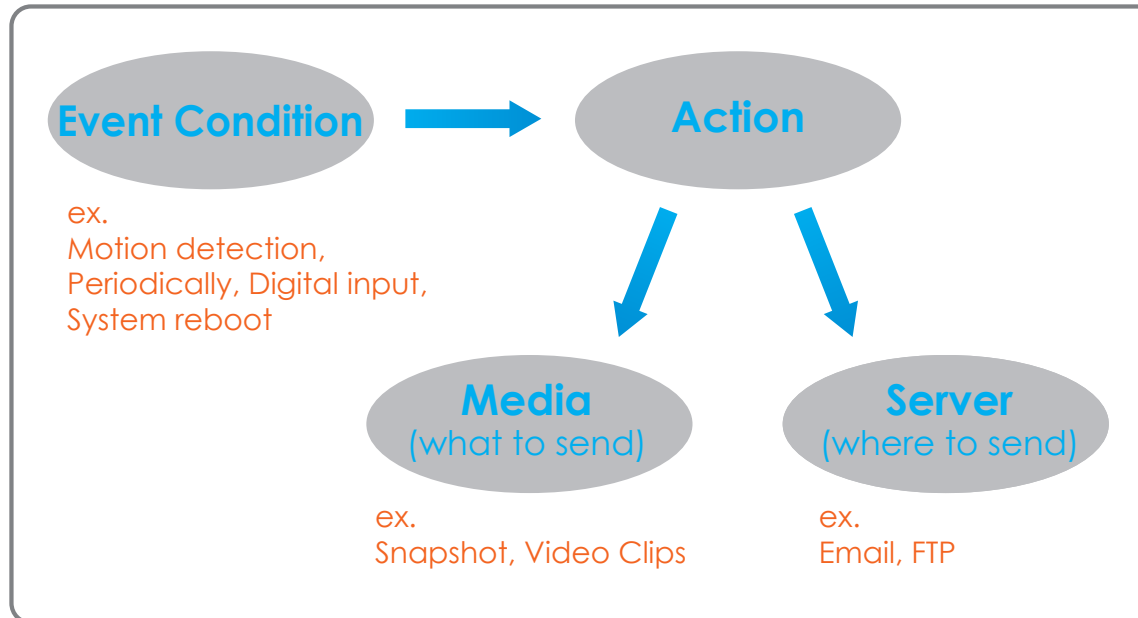

To start plotting an event, it is suggested to configure server and media columns first so that the Network Camera will know what action shall be performed when a trigger is activated.

# Add Server

You can configure up to 5 servers to save snapshots and/or video to. After making any changes, click the **Save Settings** button to save your changes.

**Server Name:** Enter the unique name of your server.

**E-mail:** Enter the configuration for the target e-mail server account.

**FTP:** Enter the configuration for the target FTP server account.

**Network Storage:** Specify a network storage device. Only one network storage device is supported.

**SD Card:** Use the camera's onboard SD card storage.



# Add Media

There are three types of media, **Snapshot**, **Video Clip**, and **System Log**. After making any changes, click the **Save Settings** button to save your changes.

**Media Name:** Enter a unique name for media type you want to create.

**Snapshot:** Select this option to set the media type to snapshots.

**Source:** Set the video profile to use as the media source. Refer to **Audio and Video** on page 30 for more information on video profiles.

**Send pre-event image(s) [0~4]:** Set the number of pre-event images to take. Pre-event images are images taken before the main event snapshot is taken.

**Send post-event image(s) [0~7]:** Set the number of post-event images to take. Post-event images are images taken after the main event snapshot is taken. You can set up to 7 post-event images to be taken.

**File name prefix:** The prefix name will be added on the file name.

**Add date and time suffix to file name:** Check it to add timing information as file name suffix.

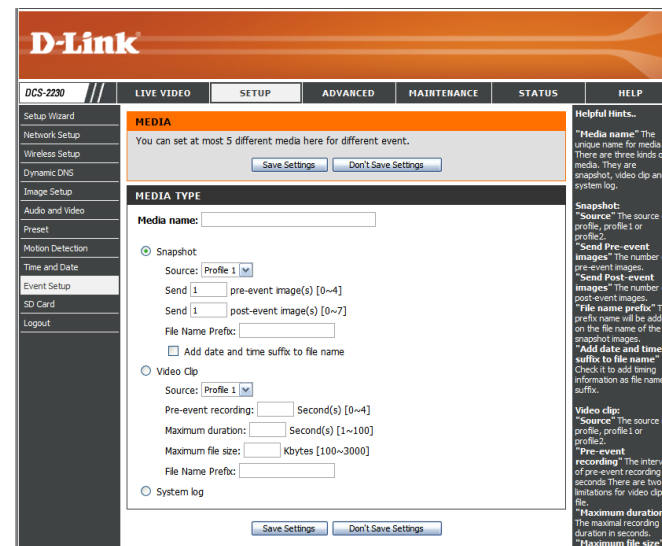

**Video clip:** Select this option to set the media type to video clips.

**Source:** Set the video profile to use as the media source. Refer to "Audio and Video" on page 30 for more information on video profiles.

**Pre-event recording:** This sets how many seconds to record before the main event video clip starts. You can record up to 4 seconds of pre-event video.

**Maximum duration:** Set the maximum length of video to record for your video clips.

**Maximum file size:** Set the maximum file size to record for your video clips.

**File name prefix:** This is the prefix that will be added to the filename of saved video clips.

**System log:** Select this option to set the media type to system logs. This will save the event to the camera system log, but will not record any snapshots or video.

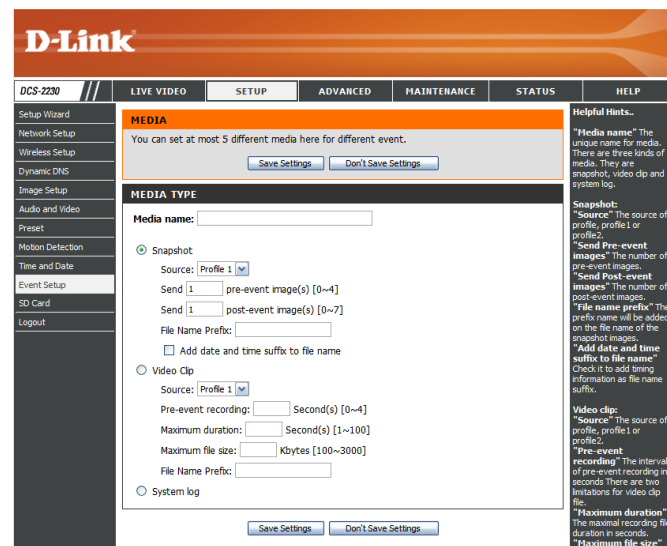



# Add Event

Create and schedule up to 3 events with their own settings here. After making any changes, click the **Save Settings** button to save your changes.

**Event name:** Enter a name for the event.

**Enable this event:** Select this box to activate this event.

**Priority:** Set the priority for this event. The event with higher priority will be executed first.

**Delay:** Select the delay time before checking the next event. It is being used for both events of motion detection and digital input trigger.

**Trigger:** Specify the input type that triggers the event.

**Video Motion Detection:** Motion is detected during live video monitoring. Select the windows that need to be monitored.

**Periodic:** The event is triggered in specified intervals. The trigger interval unit is in minutes.

**Digital input:** The external trigger input to the camera.

**System Boot:** Triggers an event when the system boots up.

**Network Lost:** Triggers an event when the network connection is lost.

**Passive Infrared:** Triggers an event when the PIR sensor is activated by moving infrared objects even in dark environment.

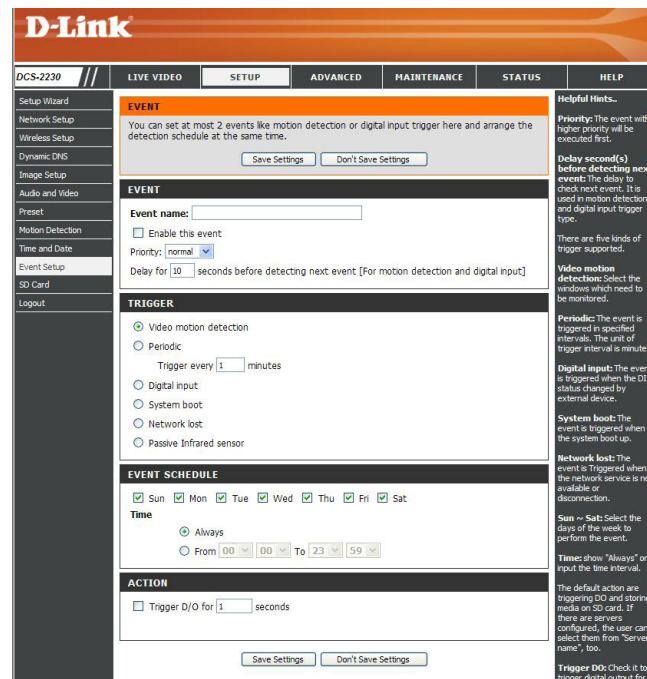

**Time:** Select **Always** or enter the time interval.

**Trigger D/O:** Select to trigger the digital output for a specific number of seconds when an event occurs.

**Server:** Specify the location where the event information should be saved to.

**D-Link**

DCS-2220 // LIVE VIDEO SETUP ADVANCED MAINTENANCE STATUS HELP

**EVENT**

You can set at most 2 events like motion detection or digital input trigger here and arrange the detection schedule at the same time.

Save Settings Don't Save Settings

**EVENT**

Event name:

Enable this event

Priority:

Delay for  seconds before detecting next event [For motion detection and digital input]

**TRIGGER**

Video motion detection

Periodic

Trigger every  minutes

Digital input

System boot

Network lost

**EVENT SCHEDULE**

Sun  Mon  Tue  Wed  Thu  Fri  Sat

Time

Always

From   To

**ACTION**

Trigger D/O for  seconds

Save Settings Don't Save Settings

**Helpful Hints...**

**Priority:** The event with higher priority will be executed first.

**Delay second(s) before detecting next event:** The delay to check next event. It is used in motion detection and digital input trigger type.

There are five kinds of trigger supported.

**Video motion detection:** select the windows which need to be monitored.

**Periodic:** The event is triggered in specified intervals. The unit of trigger interval is minute.

**Digital input:** The event is triggered when the DI status changed by external device.

**System boot:** The event is triggered when the system boot up.

**Network lost:** The event is triggered when the network service is not available or disconnection.

**Sun ~ Sat:** Select the days of the week to perform the event.

Time: show "Always" or input the time interval.

The default action are triggering DO and storing media on SD card. If there are servers configured, the user can select them from 'Server'

# Add Recording

Here you can configure and schedule the recording settings. After making any changes, click the **Save Settings** button to save your changes.

**Recording entry name:** The unique name of the entry.

**Enable this recording:** Select this to enable the recording function.

**Priority:** Set the priority for this entry. The entry with a higher priority value will be executed first.

**Source:** The source of the stream.

**Recording schedule:** Scheduling the recording entry.

**Recording settings:** Configuring the setting for the recording.

**Destination:** Select the folder where the recording file will be stored.

**Total cycling recording size:** Please input a HDD volume between 1MB and 200GB for recording space. The recording data will replace the oldest record when the total recording size exceeds this value. For example, if each recording file is 6MB, and the total cyclic recording size is 600MB, then the camera will record 100 files in the specified location (folder) and then will delete the oldest file and create new file for cyclic recording.

Please note that if the free HDD space is not enough, the recording will stop. Before you set up this option please make sure your HDD has enough space, and it is better to not save other files in the same folder as recording files.

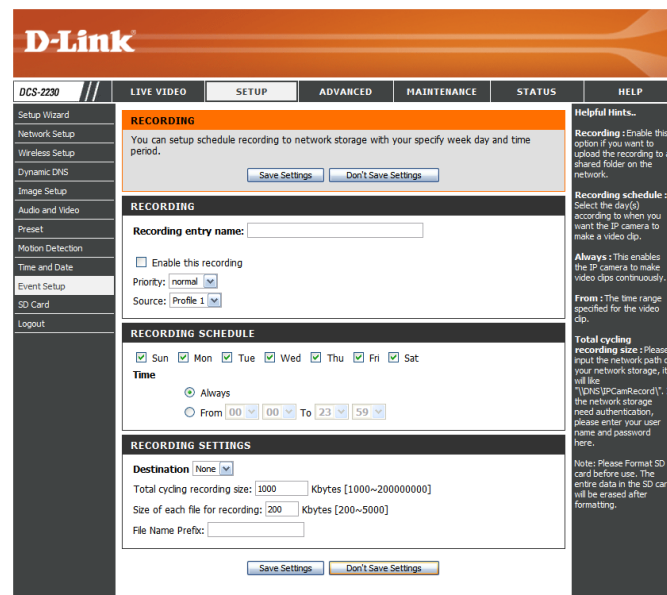

**Size of each file for recording:** File size for each recording file. You may input the value in the range of 200-5000.

**File Name Prefix:** The prefix name will be added on the file name of the recording file(s).

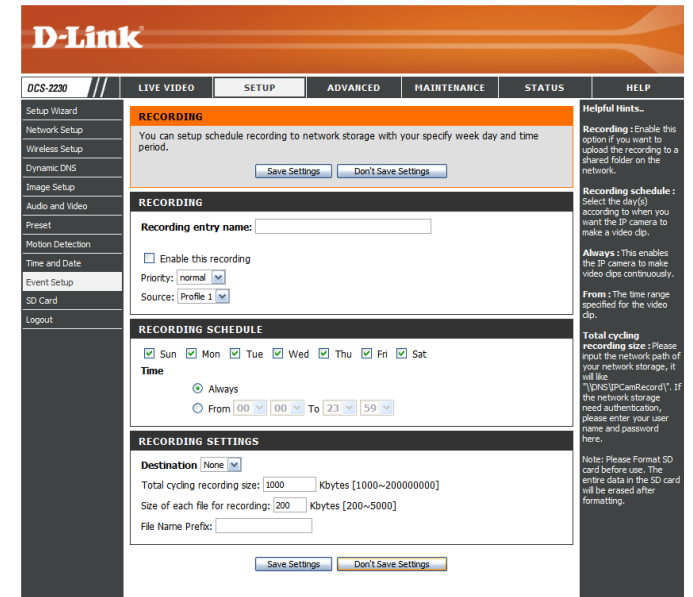

# SD Card

Here you may browse and manage the recorded files which are stored on the SD card.

**Format SD Card:** Click this icon to automatically format the SD card and create "picture" & "video" folders.

**View Recorded Picture:** If the picture files are stored on the SD card, click on the picture folder and choose the picture file you would like to view.

**Playback Recorded Video:** If video files are stored on the SD card, click on the video folder and choose the video file you would like to view.

**Refresh:** Reloads the file and folder information from the SD card.

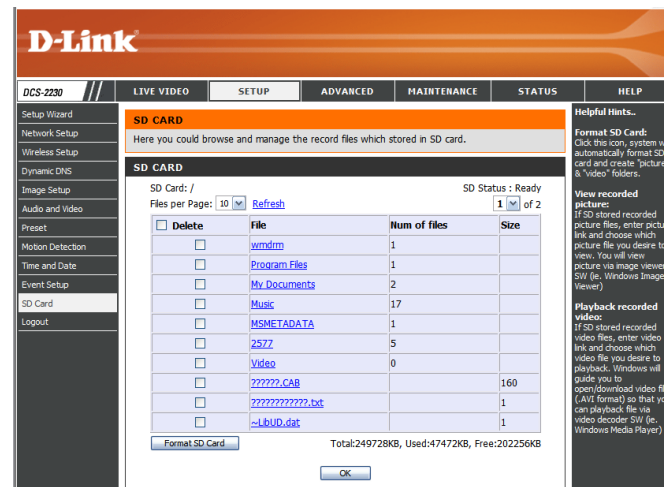

# Advanced

## Digital Input/Output

This screen allows you to control the behavior of digital input and digital output devices. The I/O connector provides the physical interface for digital output (DO) and digital input (DI) that is used for connecting a variety of external alarm devices such as IR-Sensors and alarm relays. The digital input is used for connecting external alarm devices and once triggered images will be taken and e-mailed. After making any changes, click the **Save Settings** button to save your changes.

**Select D/I or D/O Mode:** The camera will send a signal when an event is triggered, depending upon the type of device connected to the DI circuit.

N.C. stands for **Normally Closed**. This means that the normal state of the circuit is closed. Therefore events are triggered when the device status changes to "Open."

N.O. stands for **Normally Open**. This means that the normal state of the circuit is open. Therefore events are triggered when the device status changes to "Closed."

**LED:** You may specify whether or not to illuminate the LED on the side of the camera.

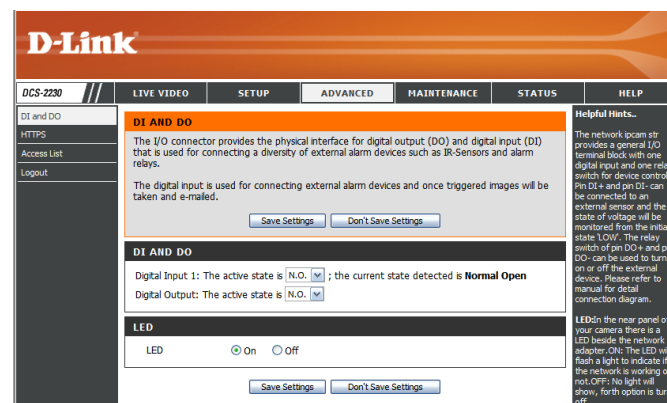

## ICR and IR

Here you can configure the ICR and IR settings. An IR(Infrared) Cut-Removable(ICR) filter can be disengaged for increased sensitivity in low light environments.

**Automatic:** The Day/Night mode is set automatically. Generally, the camera uses Day mode and switches to Night mode when needed.

**Day Mode:** Day mode enables the IR Cut Filter.

**Night Mode:** Night mode disables the IR Cut Filter.

**Schedule Mode:** Set up the Day/Night mode using a schedule. The camera will enter Day mode at the starting time and return to Night mode at the ending time.

**IR Light Control:** The camera can enable or disable the IR (infrared) light according to your preferences. This setting provides additional controls depending on your specific application.

**Off:** The IR light will always be off.

**On:** The IR light will always be on.

**Sync:** The IR light will turn on when the ICR sensor is on.

**Schedule:** The IR light will turn on or off according to the schedule that you specify below.



# HTTPS

This page allows you to install and activate an HTTPS certificate for secure access to your camera. After making any changes, click the **Save Settings** button to save your changes.

**Enable HTTPS Secure Connection:** Enable the HTTPS service.

**Create Certificate Method:** Choose the way the certificate should be created. Three options are available:

- Create a self-signed certificate automatically
- Create a self-signed certificate manually
- Create a certificate request and install

**Status:** Displays the status of the certificate.

**Note:** The certificate cannot be removed while the HTTPS is still enabled. To remove the certificate, you must first uncheck **Enable HTTPS secure connection**.

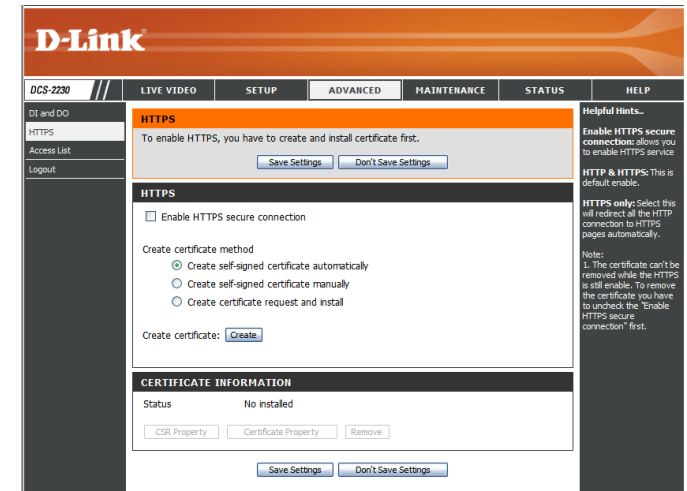



# Access List

Here you can set access permissions for users to view your DCS-2210/2230.

**Allow list:** The list of IP addresses that have the access right to the camera.

**Start IP address:** The starting IP Address of the devices (such as a computer) that have permission to access the video of the camera. Click **Add** to save the changes made.

**Note:** A total of seven lists can be configured for both columns.

**End IP address:** The ending IP Address of the devices (such as a computer) that have permission to access the video of the camera.

**Delete allow list:** Remove the customized setting from the Allow List.

**Deny list:** The list of IP addresses that have no access rights to the camera.

**Delete deny list:** Remove the customized setting from the Delete List.

**For example:**

When the range of the Allowed List is set from 1.1.1.0 to 192.255.255.255 and the range of the Denied List is set from 1.1.1.0 to 170.255.255.255. Only users with IPs located between 171.0.0.0 and 192.255.255.255 can access the Network Camera.

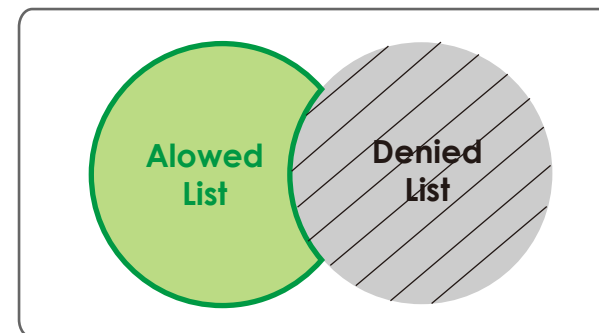
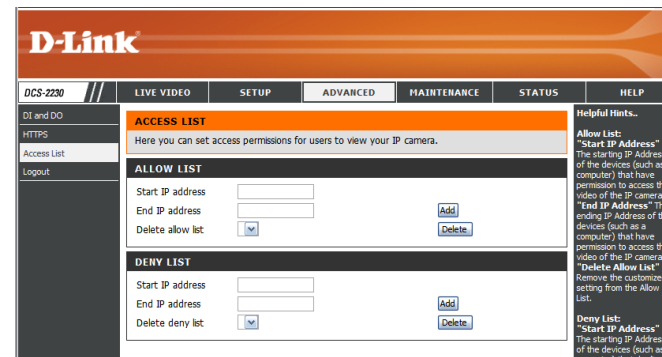

# Maintenance

## Device Management

You may modify the name and administrator's password of your camera, as well as add and manage the user accounts for accessing the camera. You may also use this section to create a unique name and configure the OSD settings for your camera.

**Admin Password Setting:** Set a new password for the administrator's account.

**Add User Account:** Add new user account.

**User Name:** The user name for the new account.

**Password:** The password for the new account.

**User List:** All the existing user accounts will be displayed here. You may delete accounts included in the list, but please reserve at least one as guest.

**Camera Name:** Create a unique name for your camera that will be added to the file name prefix when creating a snapshot or a video clip.

**Enable OSD:** Select this option to enable the On-Screen Display feature for your camera.

**Label:** Enter a label for the camera.

**Show Time:** Select this option to enable the time-stamp display on the video screen.

**D-Link**

DCS-2230 // LIVE VIDEO SETUP ADVANCED MAINTENANCE STATUS HELP

Admin  
System  
Firmware Upgrade  
Logout

**ADMIN**  
Here you can change the administrator's password for your IP camera as well as add and/or delete user account(s). You can configure the information, such as IP camera's name and time via this page. You can also enable the OSD (On-Screen Display) feature in order to display the IP camera name and time stamp for your video recordings.

**ADMIN PASSWORD SETTING**  
New Password  63 characters maximum  
Retype Password  Save

**ADD USER ACCOUNT**  
User Name  20 users maximum  
New Password  63 characters maximum  
Retype Password   
Add

**USER LIST**  
User Name  -- User list -- Delete

**DEVICE SETTING**  
IP camera Name  DCS-2230 63 characters maximum  
 Enable OSD  
Label  DCS-2230 63 characters maximum  
Show time   
Save

**Helpful Hints..**  
Enabling OSD, the IP camera name and time will be displayed on the video screen for the user.  
For security purposes, it is recommended that you change the password for your administrator account. Be sure to write down the new password to avoid having to reset the IP camera in the event that it is forgotten.

# Backup and Restore

In this section, you may backup, restore and reset the camera configuration, or reboot the camera.

**Save To Local Hard Drive:** You may save and document your current settings into your computer.

**Local From Local Hard Drive:** Locate a pre-saved configuration by clicking **Browse** and then restore the pre-defined settings to your camera by clicking **Load Configuration**.

**Restore to Factory Default:** You may reset your camera and restore the factory settings by clicking **Restore Factory Defaults**.

**Reboot Device:** This will restart your camera.

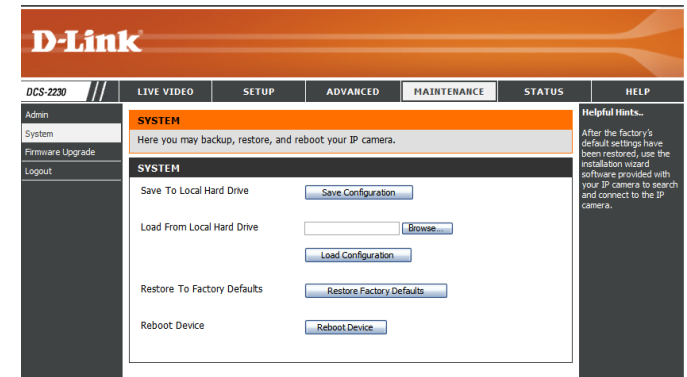

# Firmware Upgrade

The camera's current firmware version will be displayed on this screen. You may visit the D-Link Support Website to check for the latest available firmware version.

To upgrade the firmware on your DCS-2210/2230, please download and save the latest firmware version from the D-Link Support Page to your local hard drive. Locate the file on your local hard drive by clicking the **Browse** button. Select the file and click the **Upload** button to start upgrading the firmware.

**Current Firmware Version:** Displays the detected firmware version.

**Current Product Name:** Displays the camera model name.

**File Path:** Locate the file (upgraded firmware) on your hard drive by clicking **Browse**.

**Upload:** Uploads the new firmware to your camera.

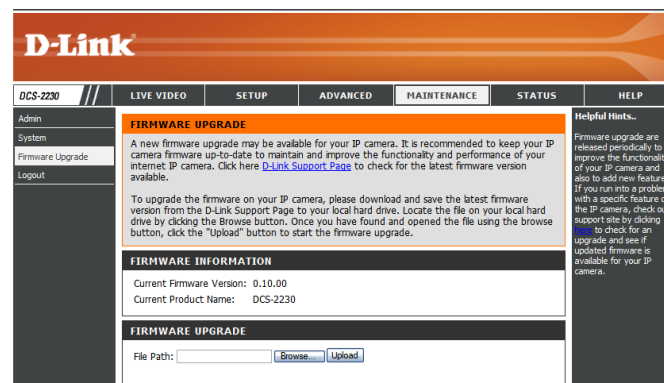

# Status

## Device Info

This page displays detailed information about your device and network connection.

The screenshot shows the D-Link web interface for a DCS-2230 device. The top navigation bar includes links for LIVE VIDEO, SETUP, ADVANCED, MAINTENANCE, STATUS (selected), and HELP. The left sidebar contains links for Device Info, Log, and Logout. The main content area is titled 'DEVICE INFO' and contains a message: 'All of your network connection details are displayed on this page. The firmware version is also displayed here.' Below this is an 'INFORMATION' table with the following data:

INFORMATION	
IP camera Name	DCS-2230
Time & Date	Fri Jan 7 16:48:32 2011
Firmware Version	0.10.00
MAC Address	AA:BB:CC:11:22:33
IP Address	172.17.5.116
IP Subnet Mask	255.255.255.0
Default Gateway	172.17.5.254
Primary DNS	192.168.168.250
Secondary DNS	192.168.168.201
PPPoE	Disable
DDNS	Disable

On the right side, there is a 'Helpful Hints..' section with the text: 'This page displays all the information about the IP camera and network settings.'

# Logs

This page displays the log information of your camera. You may download the information by clicking **Download**. You may also click **Clear** to delete the saved log information.

The screenshot shows the D-Link configuration interface for a DCS-2230 camera. The top navigation bar includes links for LIVE VIDEO, SETUP, ADVANCED, MAINTENANCE, STATUS, and HELP. The left sidebar contains links for Device Info, Log, and Logout. The main content area is titled 'SYSTEM LOG' and contains a description: 'The system log records IP camera events that have occurred.' Below this is a 'CURRENT LOG' section with a list of 20 log entries. At the bottom of the log list are buttons for 'First Page', 'Previous 20', 'Next 20', 'Clear', and 'Download'. A 'Helpful Hints..' section on the right explains that users can save the log to their local hard IP camera by clicking the Download button and clear the log by clicking the Clear button.

**D-Link**

DCS-2230 // LIVE VIDEO SETUP ADVANCED MAINTENANCE STATUS HELP

Device Info  
Log  
Logout

**SYSTEM LOG**  
The system log records IP camera events that have occurred.

**CURRENT LOG**

1. 2011-01-07 16:29:50 admin LOGIN OK FROM 172.17.5.123
2. 2011-01-07 16:27:53 IP CAMERA ACQUIRE DHCP IP 172.17.5.116
3. 2011-01-07 16:27:47 SYSTEM SET DCPOWER ON
4. 2011-01-07 16:27:42 SYSTEM BOOTING
5. 2011-01-01 00:27:49 NETWORK LOST
6. 2011-01-01 00:03:25 admin FROM 172.17.5.150 SET VIDEO CODEC Need Reset
7. 2011-01-01 00:03:25 admin FROM 172.17.5.150 SET PROFILE1 Constant Bit Rate
8. 2011-01-01 00:03:25 admin FROM 172.17.5.150 SET PROFILE1 Frame Size 640x360 Need Reset
9. 2011-01-01 00:01:53 admin LOGIN OK FROM 172.17.5.150
10. 2011-01-01 00:00:11 IP CAMERA ACQUIRE DHCP IP 172.17.5.158
11. 2011-01-01 00:00:04 SYSTEM SET DCPOWER ON
12. 2011-01-01 00:00:00 SYSTEM BOOTING
13. 2011-05-17 15:41:47 admin LOGIN OK FROM 172.17.5.130
14. 2011-05-17 15:40:15 IP CAMERA ACQUIRE DHCP IP 172.17.5.141
15. 2011-05-17 15:40:08 SYSTEM SET DCPOWER ON
16. 2011-05-17 15:40:03 SYSTEM BOOTING
17. 2011-05-11 17:24:01 admin LOGIN OK FROM 10.1.1.3
18. 2011-05-11 17:23:48 IP CAMERA ACQUIRE DHCP IP 10.1.1.4
19. 2011-05-11 17:23:42 SYSTEM SET DCPOWER ON
20. 2011-05-11 17:23:37 SYSTEM BOOTING

First Page Previous 20 Next 20  
Clear Download

**Helpful Hints..**  
You can save the log to your local hard IP camera by clicking the Download button, and you can clear the log by clicking on the Clear button.

# Help

This page provides helpful information regarding camera operation.

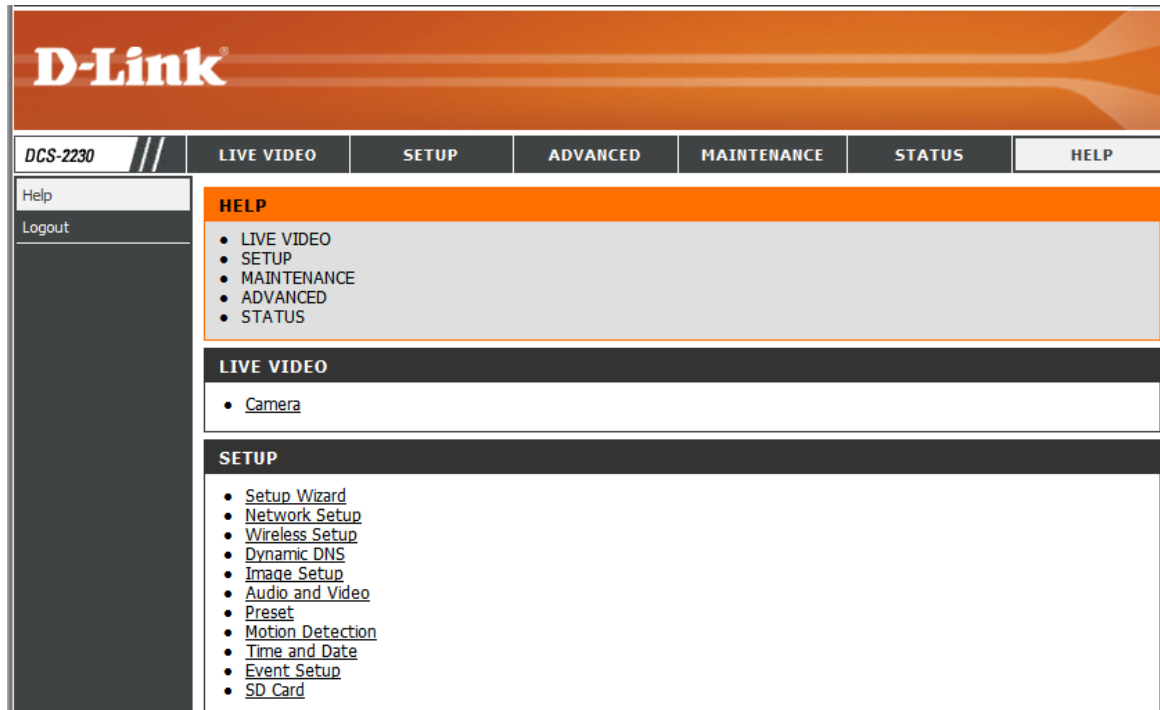

**D-Link**

DCS-2230 // LIVE VIDEO SETUP ADVANCED MAINTENANCE STATUS HELP

Help  
Logout

**HELP**

- [LIVE VIDEO](#)
- [SETUP](#)
- [MAINTENANCE](#)
- [ADVANCED](#)
- [STATUS](#)

**LIVE VIDEO**

- [Camera](#)

**SETUP**

- [Setup Wizard](#)
- [Network Setup](#)
- [Wireless Setup](#)
- [Dynamic DNS](#)
- [Image Setup](#)
- [Audio and Video](#)
- [Preset](#)
- [Motion Detection](#)
- [Time and Date](#)
- [Event Setup](#)
- [SD Card](#)

# DI/DO Input Specifications

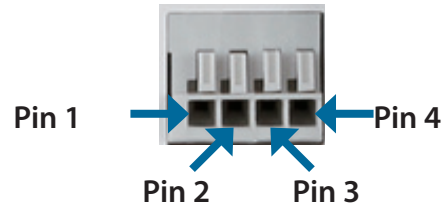

PIN	FUNCTION	NOTE
1	Digital Out (DO)	Uses an open-drain NFET transistor with the source connected to GND in camera. If used with an external relay, a diode must be connected in parallel with the load for protection against voltage transients. Max loading is 100 mA.
2	Digital In (DI)	A switch from DI to DC 5 V, activated by setting NO. or NC.
3	DC5V OUTPUT	DC 5 V Output / Max. 100 mA
4	GND	GND

### Internal 5V Power

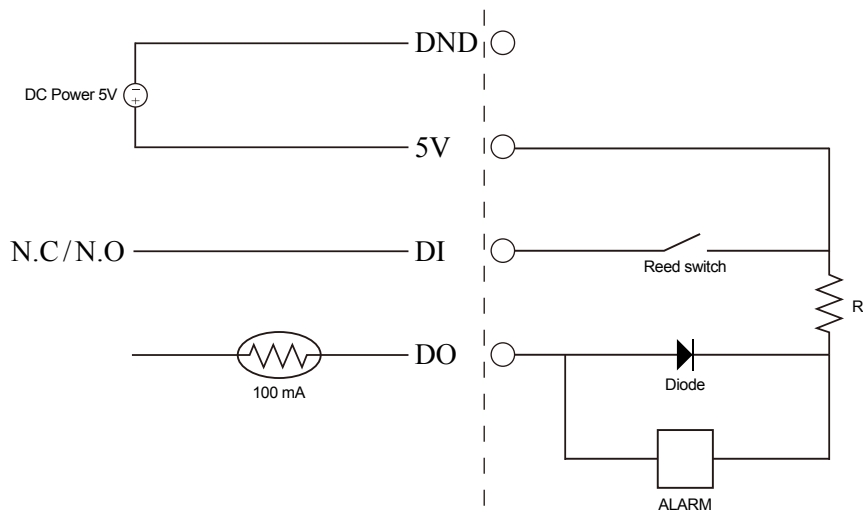

### External 3~12V Power

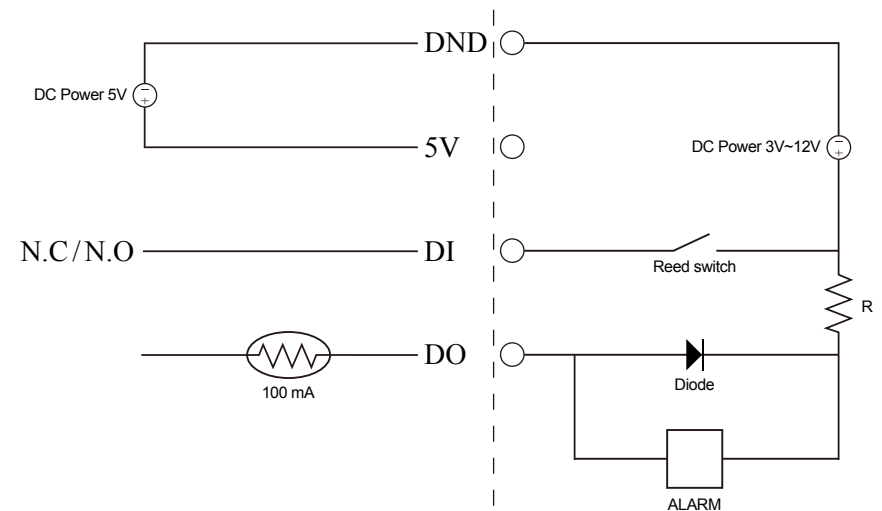



# Technical Specifications

<b>Camera</b>	Camera Hardware Profile	<ul style="list-style-type: none"> <li>• 1/2.7" 2 Megapixel progressive CMOS sensor</li> <li>• IR illumination distance: 5 m</li> <li>• Minimum illumination 0 lux with IR illumination</li> <li>• Built-in Infrared-Cut Removable (ICR)</li> <li>• Iiter module</li> <li>• Built-in PIR sensor</li> <li>• Built-in microphone and speaker</li> <li>• 10x digital zoom</li> <li>• Fixed length 4.37 mm</li> </ul>	<ul style="list-style-type: none"> <li>• Aperture F2.0</li> <li>• Angle of view: (H) 67.4° (V) 40.8° (D) 75°</li> </ul>
	Image Features	<ul style="list-style-type: none"> <li>• Configurable image size, quality, frame rate, and bit rate</li> <li>• Time stamp and text overlays</li> <li>• Configurable motion detection windows</li> </ul>	<ul style="list-style-type: none"> <li>• 3 configurable privacy mask zones</li> <li>• Configurable shutter speed, brightness, saturation, contrast, and sharpness</li> </ul>
	Video Compression	<ul style="list-style-type: none"> <li>• Simultaneous H.264/MPEG-4/MJPEG format compression</li> <li>• JPEG for still image</li> <li>• H.264/MPEG-4 multicast streaming</li> </ul>	
	Video Resolution	16:9 - 1920 x 1080 (up to 15 fps), 1280 x 720, 800 x 450, 640 x 360, 480 x 270, 320 x 176, 176 x 144 up to 30 fps 4:3 - 1440 x 1080 (up to 15 fps), 1280 x 960, 1024 x 768, 800 x 600, 640 x 480, 320 x 240, 176 x 144 up to 30 fps	
	Audio Support	G.726	
	External Device Interface	<ul style="list-style-type: none"> <li>• 1 DI / 1 DO</li> <li>• Micro SD card slot</li> </ul>	
<b>Network</b>	Network Protocols	IPv4, TCP/IP, UDP, ICMP, DHCP Client, NTP Client (D-Link), DNS Client, DDNS Client (D-Link), SMTP Client, FTP Client, HTTP / HTTPS, Samba Client, PPPoE, UPnP Port Forwarding, RTP / RTSP/ RTCP, IP filtering, 3GPP, IGMP, ONVIF Compliant	
	Security	<ul style="list-style-type: none"> <li>• Administrator and user group protection</li> <li>• Password authentication</li> </ul>	<ul style="list-style-type: none"> <li>• HTTP and RTSP digest encryption</li> </ul>

# Technical Specifications

<b>System Management</b>	System Requirements for Web Interface	<ul style="list-style-type: none"> <li>• Operating System: Microsoft Windows 7/Vista/XP/2000</li> <li>• Browser: Internet Explorer, Firefox, Netscape, Opera</li> </ul>
	Event Management	<ul style="list-style-type: none"> <li>• Motion detection</li> <li>• Event notification and upload snapshots/video clips via HTTP, SMTP, or FTP</li> </ul> <ul style="list-style-type: none"> <li>• Supports multiple HTTP, SMTP, and FTP servers</li> <li>• Multiple event notifications</li> <li>• Multiple recording methods for easy backup</li> </ul>
	Remote Management	<ul style="list-style-type: none"> <li>• Configuration accessible via web browser</li> <li>• Take snapshots/video clips and save to local hard drive or NAS via web browser</li> </ul>
	Mobile Support	Windows 7/Vista/XP system, Pocket PC, or mobile phone with 3GPP playback support
	D-ViewCam™ System Requirements	<ul style="list-style-type: none"> <li>• Operating System: Microsoft Windows 7/Vista/XP</li> <li>• Web Browser: Internet Explorer 6 or higher</li> </ul> <ul style="list-style-type: none"> <li>• Protocol: Standard TCP/IP</li> </ul>
	D-ViewCam™ Software Functions	<ul style="list-style-type: none"> <li>• Remote management/control of up to 32 cameras</li> <li>• Viewing of up to 32 cameras on one screen</li> </ul> <ul style="list-style-type: none"> <li>• Supports all management functions provided in web interface</li> <li>• Scheduled motion triggered, or manual recording options</li> </ul>
<b>General</b>	Power Input	5 V DC 1.2 A, 50/60 Hz, PoE ( DCS-2210 only )
	Max. Power Consumption	DCS-2210: 3.5 watts DCS-2230: 4 watts
	Operating Temperature	0 to 40 °C (32 to 104 °F)
	Storage Temperature	-20 to 70 °C (-4 to 158 °F)
	Humidity	20% to 80% non-condensing
	Weight	DCS-2210: 80 g DCS-2230: 75 g
	Certifications	CE, CE LVD, FCC(Class B), C-Tick

\*This device complies with part 15 of the FCC Rules.

Operation is subject to the following two conditions:

(1) This device may not cause harmful interference.

(2) This device must accept any interference received, including interference that may cause undesired operation.

Dimensions

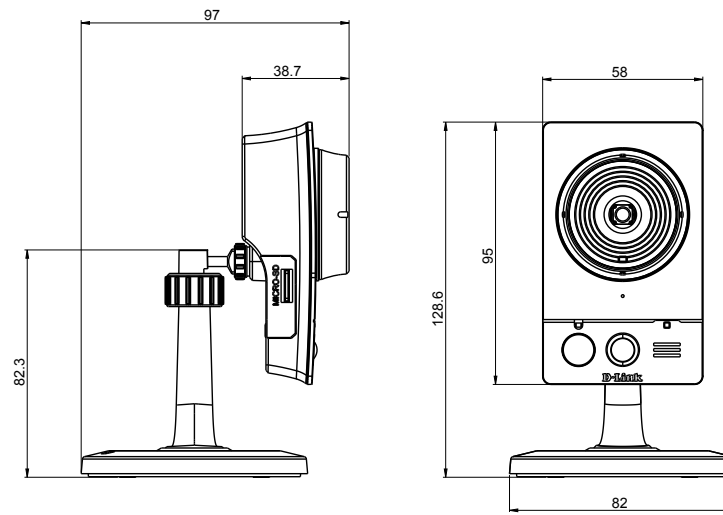

# Contacting Technical Support

U.S. and Canadian customers can contact D-Link technical support through our web site or by phone.

Before you contact technical support, please have the following ready:

- Model number of the product (e.g. DCS-2210/2230)
- Hardware Revision (located on the label on the bottom of the Network Camera (e.g. rev A1))
- Serial Number (s/n number located on the label on the bottom of the Network Camera).

You can find software updates and user documentation on the D-Link website as well as frequently asked questions and answers to technical issues.

## For customers within the United States:

**Phone Support:**

(877) 354-6555

**Internet Support:**

<http://support.dlink.com>

## For customers within Canada:

**Phone Support:**

(800) 354-6560

**Internet Support:**

<http://support.dlink.ca>

# Warranty

Subject to the terms and conditions set forth herein, D-Link Systems, Inc. (“D-Link”) provides this Limited Warranty:

- Only to the person or entity that originally purchased the product from D-Link or its authorized reseller or distributor, and
- Only for products purchased and delivered within the fifty states of the United States, the District of Columbia, U.S. Possessions or Protectorates, U.S. Military Installations, or addresses with an APO or FPO.

### **Limited Warranty:**

D-Link warrants that the hardware portion of the D-Link product described below (“Hardware”) will be free from material defects in workmanship and materials under normal use from the date of original retail purchase of the product, for the period set forth below (“Warranty Period”), except as otherwise stated herein.

- Hardware (excluding power supplies and fans): One (1) year
- Power supplies and fans: One (1) year
- Spare parts and spare kits: Ninety (90) days

The customer’s sole and exclusive remedy and the entire liability of D-Link and its suppliers under this Limited Warranty will be, at D-Link’s option, to repair or replace the defective Hardware during the Warranty Period at no charge to the original owner or to refund the actual purchase price paid. Any repair or replacement will be rendered by D-Link at an Authorized D-Link Service Office. The replacement hardware need not be new or have an identical make, model or part. D-Link may, at its option, replace the defective Hardware or any part thereof with any reconditioned product that D-Link reasonably determines is substantially equivalent (or superior) in all material respects to the defective Hardware. Repaired or replacement hardware will be warranted for the remainder of the original Warranty Period or ninety (90) days, whichever is longer, and is subject to the same limitations and exclusions. If a material defect is incapable of correction, or if D-Link determines that it is not practical to repair or replace the defective Hardware, the actual price paid by the original purchaser for the defective Hardware will be refunded by D-Link upon return to D-Link of the defective Hardware. All Hardware or part thereof that is replaced by D-Link, or for which the purchase price is refunded, shall become the property of D-Link upon replacement or refund.

### **Limited Software Warranty:**

D-Link warrants that the software portion of the product (“Software”) will substantially conform to D-Link’s then current functional specifications for the Software, as set forth in the applicable documentation, from the date of original retail purchase of the Software for a period of ninety (90) days (“Software Warranty Period”), provided that the Software is properly installed on approved hardware and operated as contemplated in its documentation. D-Link further warrants that, during the Software Warranty Period, the magnetic media on which D-Link delivers the Software will be free of physical defects. The customer’s sole and exclusive remedy and the entire liability of D-Link and its suppliers under this Limited Warranty will be, at D-Link’s option, to replace the non-conforming Software (or defective media) with software that substantially conforms to D-Link’s functional specifications for the Software or to refund the portion of the actual purchase price paid that is attributable to the Software. Except as otherwise agreed by DLink in writing, the replacement Software is provided only to the original licensee, and is subject to the terms and conditions of the license granted by D-Link for the Software. Replacement Software will be warranted for the remainder of the original Warranty Period and is subject to the same limitations and exclusions. If a material non-conformance is incapable of correction, or if D-Link determines in its sole discretion that it is not practical to replace the non-conforming Software, the price paid by the original licensee for the non-conforming Software will be refunded by D-Link; provided that the non-conforming Software (and all copies thereof) is first returned to D-Link. The license granted respecting any Software for which a refund is given automatically terminates.

### **Non-Applicability of Warranty:**

The Limited Warranty provided hereunder for Hardware and Software portions of D-Link’s products will not be applied to and does not cover any refurbished product and any product purchased through the inventory clearance or liquidation sale or other sales in which D-Link, the sellers, or the liquidators expressly disclaim their warranty obligation pertaining to the product and in that case, the product is being sold “As-Is” without any warranty whatsoever including, without limitation, the Limited Warranty as described herein, notwithstanding anything stated herein to the contrary.

### **Submitting A Claim:**

The customer shall return the product to the original purchase point based on its return policy. In case the return policy period has expired and the product is within warranty, the customer shall submit a claim to D-Link as outlined below:

- The customer must submit with the product as part of the claim a written description of the Hardware defect or Software nonconformance in sufficient detail to allow D-Link to confirm the same, along with proof of purchase of the product (such as a copy of the dated purchase invoice for the product) if the product is not registered.
- The customer must obtain a Case ID Number from D-Link Technical Support (USA 1-877-453-5465 or Canada 1-800-361-5265), who will attempt to assist the customer in resolving any suspected defects with the product. If the product is considered defective, the customer must obtain a Return Material Authorization (“RMA”) number by completing the RMA form. Enter the assigned Case ID Number at <https://rma.dlink.com/> (USA only) or <https://rma.dlink.ca> (Canada only).

- After an RMA number is issued, the defective product must be packaged securely in the original or other suitable shipping package to ensure that it will not be damaged in transit, and the RMA number must be prominently marked on the outside of the package. Do not include any manuals or accessories in the shipping package. D-Link will only replace the defective portion of the product and will not ship back any accessories.
- The customer is responsible for all in-bound shipping charges to D-Link. No Cash on Delivery (“COD”) is allowed. Products sent COD will either be rejected by D-Link or become the property of D-Link. Products shall be fully insured by the customer and shipped to D-Link Systems, Inc.
- USA residents send to 17595 Mt. Herrmann, Fountain Valley, CA 92708. D-Link will not be held responsible for any packages that are lost in transit to D-Link. The repaired or replaced packages will be shipped to the customer via UPS Ground or any common carrier selected by D-Link. Return shipping charges shall be prepaid by D-Link if you use an address in the United States, otherwise we will ship the product to you freight collect. Expedited shipping is available upon request and provided shipping charges are prepaid by the customer. D-Link may reject or return any product that is not packaged and shipped in strict compliance with the foregoing requirements, or for which an RMA number is not visible from the outside of the package. The product owner agrees to pay D-Link’s reasonable handling and return shipping charges for any product that is not packaged and shipped in accordance with the foregoing requirements, or that is determined by D-Link not to be defective or non-conforming.
- Canadian residents send to D-Link Networks, Inc., 2525 Meadowvale Boulevard Mississauga, Ontario, L5N 5S2 Canada. D-Link will not be held responsible for any packages that are lost in transit to D-Link. The repaired or replaced packages will be shipped to the customer via Purolator Canada or any common carrier selected by D-Link. Return shipping charges shall be prepaid by D-Link if you use an address in Canada, otherwise we will ship the product to you freight collect. Expedited shipping is available upon request and provided shipping charges are prepaid by the customer. D-Link may reject or return any product that is not packaged and shipped in strict compliance with the foregoing requirements, or for which an RMA number is not visible from the outside of the package. The product owner agrees to pay D-Link’s reasonable handling and return shipping charges for any product that is not packaged and shipped in accordance with the foregoing requirements, or that is determined by D-Link not to be defective or non-conforming. RMA phone number: 1-800-361-5265 Hours of Operation: Monday-Friday, 9:00AM – 9:00PM EST.

### **What Is Not Covered:**

The Limited Warranty provided herein by D-Link does not cover:

Products that, in D-Link’s judgment, have been subjected to abuse, accident, alteration, modification, tampering, negligence, misuse, faulty installation, lack of reasonable care, repair or service in any way that is not contemplated in the documentation for the product, or if the model or serial number has been altered, tampered with, defaced or removed; Initial installation, installation and removal of the product for repair, and shipping costs; Operational adjustments covered in the operating manual for the product, and normal maintenance; Damage that occurs in shipment, due to act of God, failures due to power surge, and cosmetic damage; Any hardware, software, firmware or other products or services provided by anyone other than D-Link; and Products that have been purchased from inventory clearance or liquidation sales or other sales in which D-Link, the sellers,

## Warranty

---

or the liquidators expressly disclaim their warranty obligation pertaining to the product.

While necessary maintenance or repairs on your Product can be performed by any company, we recommend that you use only an Authorized D-Link Service Office. Improper or incorrectly performed maintenance or repair voids this Limited Warranty.

### **Disclaimer of Other Warranties:**

EXCEPT FOR THE LIMITED WARRANTY SPECIFIED HEREIN, THE PRODUCT IS PROVIDED "AS-IS" WITHOUT ANY WARRANTY OF ANY KIND WHATSOEVER INCLUDING, WITHOUT LIMITATION, ANY WARRANTY OF MERCHANTABILITY, FITNESS FOR A PARTICULAR PURPOSE AND NONINFRINGEMENT.

IF ANY IMPLIED WARRANTY CANNOT BE DISCLAIMED IN ANY TERRITORY WHERE A PRODUCT IS SOLD, THE DURATION OF SUCH IMPLIED WARRANTY SHALL BE LIMITED TO THE DURATION OF THE APPLICABLE WARRANTY PERIOD SET FORTH ABOVE. EXCEPT AS EXPRESSLY COVERED UNDER THE LIMITED WARRANTY PROVIDED HEREIN, THE ENTIRE RISK AS TO THE QUALITY, SELECTION AND PERFORMANCE OF THE PRODUCT IS WITH THE PURCHASER OF THE PRODUCT.

### **Limitation of Liability:**

TO THE MAXIMUM EXTENT PERMITTED BY LAW, D-LINK IS NOT LIABLE UNDER ANY CONTRACT, NEGLIGENCE, STRICT LIABILITY OR OTHER LEGAL OR EQUITABLE THEORY FOR ANY LOSS OF USE OF THE PRODUCT, INCONVENIENCE OR DAMAGES OF ANY CHARACTER, WHETHER DIRECT, SPECIAL, INCIDENTAL OR CONSEQUENTIAL (INCLUDING, BUT NOT LIMITED TO, DAMAGES FOR LOSS OF GOODWILL, LOSS OF REVENUE OR PROFIT, WORK STOPPAGE, COMPUTER FAILURE OR MALFUNCTION, FAILURE OF OTHER EQUIPMENT OR COMPUTER PROGRAMS TO WHICH D-LINK'S PRODUCT IS CONNECTED WITH, LOSS OF INFORMATION OR DATA CONTAINED IN, STORED ON, OR INTEGRATED WITH ANY PRODUCT RETURNED TO D-LINK FOR WARRANTY SERVICE) RESULTING FROM THE USE OF THE PRODUCT, RELATING TO WARRANTY SERVICE, OR ARISING OUT OF ANY BREACH OF THIS LIMITED WARRANTY, EVEN IF D-LINK HAS BEEN ADVISED OF THE POSSIBILITY OF SUCH DAMAGES. THE SOLE REMEDY FOR A BREACH OF THE FOREGOING LIMITED WARRANTY IS REPAIR, REPLACEMENT OR REFUND OF THE DEFECTIVE OR NONCONFORMING PRODUCT. THE MAXIMUM LIABILITY OF D-LINK UNDER THIS WARRANTY IS LIMITED TO THE PURCHASE PRICE OF THE PRODUCT COVERED BY THE WARRANTY. THE FOREGOING EXPRESS WRITTEN WARRANTIES AND REMEDIES ARE EXCLUSIVE AND ARE IN LIEU OF ANY OTHER WARRANTIES OR REMEDIES, EXPRESS, IMPLIED OR STATUTORY.

### **Governing Law:**

This Limited Warranty shall be governed by the laws of the State of California. Some states do not allow exclusion or limitation of incidental or consequential damages, or limitations on how long an implied warranty lasts, so the foregoing limitations and exclusions may not apply. This Limited Warranty provides specific legal rights and you may also have other rights which vary from state to state.

### **Trademarks:**

D-Link is a registered trademark of D-Link Corporation/D-Link Systems, Inc. Other trademarks or registered trademarks are the property of their respective owners.



### **Copyright Statement:**

No part of this publication or documentation accompanying this product may be reproduced in any form or by any means or used to make any derivative such as translation, transformation, or adaptation without permission from D-Link Corporation/D-Link Systems, Inc., as stipulated by the United States Copyright Act of 1976 and any amendments thereto. Contents are subject to change without prior notice.

Copyright ©2011 by D-Link Corporation/D-Link Systems, Inc. All rights reserved.

### **CE Mark Warning:**

This is a Class B product. In a domestic environment, this product may cause radio interference, in which case the user may be required to take adequate measures.

### **FCC Statement:**

This equipment has been tested and found to comply with the limits for a Class B digital device, pursuant to part 15 of the FCC Rules. These limits are designed to provide reasonable protection against harmful interference in a residential installation. This equipment generates, uses, and can radiate radio frequency energy and, if not installed and used in accordance with the instructions, may cause harmful interference to radio communication. However, there is no guarantee that interference will not occur in a particular installation. If this equipment does cause harmful interference to radio or television reception, which can be determined by turning the equipment off and on, the user is encouraged to try to correct the interference by one or more of the following measures:

- Reorient or relocate the receiving antenna.
- Increase the separation between the equipment and receiver.
- Connect the equipment into an outlet on a circuit different from that to which the receiver is connected.
- Consult the dealer or an experienced radio/TV technician for help.

### **FCC Caution:**

Any changes or modifications not expressly approved by the party responsible for compliance could void the user's authority to operate this equipment.

This device complies with Part 15 of the FCC Rules. Operation is subject to the following two conditions:

(1) This device may not cause harmful interference, and (2) this device must accept any interference received, including interference that may cause undesired operation.

If this device is going to be operated in 5.15 ~ 5.25GHz frequency range, then it is restricted in indoor environment only.

### **IMPORTANT NOTICE:**

#### **FCC Radiation Exposure Statement:**

This equipment complies with FCC radiation exposure limits set forth for an uncontrolled environment. This equipment should be installed and operated with minimum distance 20cm between the radiator & your body. This transmitter must not be co-located or operating in conjunction with any other antenna or transmitter.

The availability of some specific channels and/or operational frequency bands are country dependent and are firmware programmed at the factory to match the intended destination. The firmware setting is not accessible by the end user.

For detailed warranty information applicable to products purchased outside the United States, please contact the corresponding local D-Link office.

#### **Industry Canada Notice:**

This device complies with RSS-210 of the Industry Canada Rules. Operation is subject to the following two conditions:

(1) This device may not cause harmful interference, and (2) this device must accept any interference received, including interference that may cause undesired operation.

### **IMPORTANT NOTE:**

#### **Radiation Exposure Statement:**

This equipment complies with IC radiation exposure limits set forth for an uncontrolled environment. This equipment should be installed and operated with minimum distance 20cm between the radiator & your body.

This device has been designed to operate with an antenna having a maximum gain of 2 dB. Antenna having a higher gain is strictly prohibited per regulations of Industry Canada. The required antenna impedance is 50 ohms.

# Registration

Register your product online at [registration.dlink.com](http://registration.dlink.com)



Product registration is entirely voluntary and failure to complete or return this form will not diminish your warranty rights.

Version 1.0  
October 13, 2011

## Free Manuals Download Website

<http://myh66.com>

<http://usermanuals.us>

<http://www.somanuals.com>

<http://www.4manuals.cc>

<http://www.manual-lib.com>

<http://www.404manual.com>

<http://www.luxmanual.com>

<http://aubethermostatmanual.com>

Golf course search by state

<http://golfingnear.com>

Email search by domain

<http://emailbydomain.com>

Auto manuals search

<http://auto.somanuals.com>

TV manuals search

<http://tv.somanuals.com>