

XSTACK[®]

Hardware Installation Guide

Product Model: **xStack**[®] DGS-3420 Series
Layer 2+ Managed Stackable Gigabit Switch
Release 1.50



Information in this document is subject to change without notice.

© 2014 D-Link Corporation. All rights reserved.

Reproduction in any manner whatsoever without the written permission of D-Link Corporation is strictly forbidden.

Trademarks used in this text: D-Link and the D-LINK logo are trademarks of D-Link Corporation; Microsoft and Windows are registered trademarks of Microsoft Corporation.

Other trademarks and trade names may be used in this document to refer to either the entities claiming the marks and names or their products. D-Link Corporation disclaims any proprietary interest in trademarks and trade names other than its own.

November, 2014 P/N 651GS3420035G

FCC Warning

This equipment has been tested and found to comply with the limits for a Class A digital device, pursuant to Part 15 of the FCC Rules. These limits are designed to provide reasonable protection against harmful interference when the equipment is operated in a commercial environment. This equipment generates, uses, and can radiate radio frequency energy and, if not installed and used in accordance with this manual, may cause harmful interference to radio communications.

Operation of this equipment in a residential area is likely to cause harmful interference in which case the user will be required to correct the interference at his own expense.

CE Mark Warning

This is a Class A product. In a domestic environment, this product may cause radio interference in which case the user may be required to take adequate measures.

Warnung!

Dies ist ein Produkt der Klasse A. Im Wohnbereich kann dieses Produkt Funkstörungen verursachen. In diesem Fall kann vom Benutzer verlangt werden, angemessene Massnahmen zu ergreifen.

Precaución!

Este es un producto de Clase A. En un entorno doméstico, puede causar interferencias de radio, en cuyo caso, puede requerirse al usuario para que adopte las medidas adecuadas.

Attention!

Ceci est un produit de classe A. Dans un environnement domestique, ce produit pourrait causer des interférences radio, auquel cas l'utilisateur devrait prendre les mesures adéquates.

Attenzione!

Il presente prodotto appartiene alla classe A. Se utilizzato in ambiente domestico il prodotto può causare interferenze radio, nel cui caso è possibile che l'utente debba assumere provvedimenti adeguati.

VCCI Warning

この装置は、クラス A 情報技術装置です。この装置を家庭環境で使用すると電波妨害を引き起こすことがあります。この場合には使用者が適切な対策を講ずるよう要求されることがあります。 VCCI-A

BSMI Notice

此為甲類的資訊技術設備，在居住環境中使用時，可能會造成射頻擾動，在這種情況下，使用者會被要求採取某些適當的對策。

Table of Contents

Intended Readers	iv
Typographical Conventions	iv
Notes, Notices, and Cautions	iv
Safety Instructions	v
Safety Cautions	v
General Precautions for Rack-Mountable Products	vi
Protecting Against Electrostatic Discharge	vii
Chapter 1 Introduction.....	8
Switch Description	8
Features.....	9
Ports	10
Front-Panel Components	12
LED Indicators	13
Rear Panel Components	15
Side Panel Components.....	16
Chapter 2 Installation.....	18
Package Contents	18
Installation Guidelines	18
Installing the Switch without a Rack	19
Attaching Brackets to a Switch for Rack Mounting.....	19
Mounting the Switch in a Standard 19" Rack	20
Power On (AC Power).....	20
Power Failure (AC Power)	20
Alarm Connector.....	20
Installing SFP and SFP+ Ports.....	22
Connecting to a Redundant Power Supply	23
External Redundant Power System	24
DPS-900.....	24
DPS-800.....	25
Chapter 3 Connecting the Switch.....	27
Switch to End Node	27
Switch to Switch	27
Connect to a Network Backbone or Server.....	28
Chapter 4 Introduction to Switch Management	29
Management Options	29
Connecting the Console Port.....	29
Connecting to the Switch for the first time.....	31
Connecting to the Management Port.....	31
Password Protection.....	32
Assigning IP Addresses.....	32
SNMP Settings	34
Traps	35
Management Information Base (MIB)	35
Chapter 5 Web-based Switch Configuration	36
Introduction.....	36
Logging onto the Web Manager	36
Web-based User Interface.....	37

Areas of the User Interface	37
Web Pages	37
Appendix Section	39
Appendix A – Technical Specifications	39
General	39
Physical and Environmental.....	39
Performance.....	40
LED Indicators	41
Port Functions	43
Appendix B – Cables and Connectors	46
Ethernet Cable	46
Console Cable	47
Redundant Power Supply (RPS) Cable	48
Appendix C – Module Specs and Cable Lengths.....	50
Warranties.....	51
Technical Support.....	52

Intended Readers

Typographical Conventions
Notes, Notices, and Cautions
Safety Instructions

The **DGS-3420 Series Hardware Installation Guide** contains information for set up and management of the Switch. This manual is intended for network managers familiar with network management concepts and terminology. For all practical reasons all the switches in this series will be simply referred to as the Switch throughout this manual. All example screenshots are taken from the **DGS-3420-28SC** Switch. In some examples, where we refer to the Power over Ethernet examples, we'll use the **DGS-3420-28PC** Switch.

Typographical Conventions

Convention	Description
[]	In a command line, square brackets indicate an optional entry. For example: [copy filename] means that optionally you can type copy followed by the name of the file. Do not type the brackets.
Bold font	Indicates a button, a toolbar icon, menu, or menu item. For example: Open the File menu and choose Cancel . Used for emphasis. May also indicate system messages or prompts appearing on screen. For example: You have mail . Bold font is also used to represent filenames, program names and commands. For example: use the copy command .
Boldface Typewriter Font	Indicates commands and responses to prompts that must be typed exactly as printed in the manual.
Initial capital letter	Indicates a window name. Names of keys on the keyboard have initial capitals. For example: Click Enter.
<i>Italics</i>	Indicates a window name or a field. Also can indicate a variables or parameter that is replaced with an appropriate word or string. For example: type <i>filename</i> means that the actual filename should be typed instead of the word shown in italic.
Menu Name > Menu Option	Menu Name > Menu Option Indicates the menu structure. Device > Port > Port Properties means the Port Properties menu option under the Port menu option that is located under the Device menu.

Notes, Notices, and Cautions



A **NOTE** indicates important information that helps make better use of the device.



A **NOTICE** indicates either potential damage to hardware or loss of data and tells how to avoid the problem.



A **CAUTION** indicates a potential for property damage, personal injury, or death.

Safety Instructions

Use the following safety guidelines to ensure your own personal safety and to help protect your system from potential damage. Throughout this safety section, the caution icon () is used to indicate cautions and precautions that need to be reviewed and followed.

Safety Cautions

To reduce the risk of bodily injury, electrical shock, fire, and damage to the equipment observe the following precautions:

- Observe and follow service markings.
 - Do not service any product except as explained in the system documentation.
 - Opening or removing covers that are marked with the triangular symbol with a lightning bolt may expose the user to electrical shock.
 - Only a trained service technician should service components inside these compartments.
- If any of the following conditions occur, unplug the product from the electrical outlet and replace the part or contact your trained service provider:
 - Damage to the power cable, extension cable, or plug.
 - An object has fallen into the product.
 - The product has been exposed to water.
 - The product has been dropped or damaged.
 - The product does not operate correctly when the operating instructions are correctly followed.
- Keep your system away from radiators and heat sources. Also, do not block cooling vents.
- Do not spill food or liquids on system components, and never operate the product in a wet environment. If the system gets wet, see the appropriate section in the troubleshooting guide or contact your trained service provider.
- Do not push any objects into the openings of the system. Doing so can cause fire or electric shock by shorting out interior components.
- Use the product only with approved equipment.
- Allow the product to cool before removing covers or touching internal components.
- Operate the product only from the type of external power source indicated on the electrical ratings label. If unsure of the type of power source required, consult your service provider or local power company.
- To help avoid damaging the system, be sure the voltage selection switch (if provided) on the power supply is set to match the power available at the Switch's location:
 - 115 volts (V)/60 hertz (Hz) in most of North and South America and some Far Eastern countries such as South Korea and Taiwan
 - 100 V/50 Hz in eastern Japan and 100 V/60 Hz in western Japan
 - 230 V/50 Hz in most of Europe, the Middle East, and the Far East
- Also, be sure that attached devices are electrically rated to operate with the power available in your location.
- Use only approved power cable(s). If you have not been provided with a power cable for your system or for any AC-powered option intended for your system, purchase a power cable that is approved for use in your country. The power cable must be rated for the product and for the voltage and current marked on the product's electrical ratings label. The voltage and current rating of the cable should be greater than the ratings marked on the product.
- To help prevent electric shock, plug the system and peripheral power cables into properly grounded electrical outlets. These cables are equipped with three-prong plugs to help ensure proper grounding. Do not use adapter plugs or remove the grounding prong from a cable. If using an extension cable is necessary, use a 3-wire cable with properly grounded plugs.
- Observe extension cable and power strip ratings. Make sure that the total ampere rating of all products plugged into the extension cable or power strip does not exceed 80 percent of the ampere ratings limit for the extension cable or power strip.

- To help protect the system from sudden, transient increases and decreases in electrical power, use a surge suppressor, line conditioner, or uninterruptible power supply (UPS).
- Position system cables and power cables carefully; route cables so that they cannot be stepped on or tripped over. Be sure that nothing rests on any cables.
- Do not modify power cables or plugs. Consult a licensed electrician or your power company for site modifications. Always follow your local/national wiring rules.
- When connecting or disconnecting power to hot-pluggable power supplies, if offered with your system, observe the following guidelines:
 - Install the power supply before connecting the power cable to the power supply.
 - Unplug the power cable before removing the power supply.
 - If the system has multiple sources of power, disconnect power from the system by unplugging all power cables from the power supplies.
- Move products with care; ensure that all casters and/or stabilizers are firmly connected to the system. Avoid sudden stops and uneven surfaces.

General Precautions for Rack-Mountable Products

Observe the following precautions for rack stability and safety. Also, refer to the rack installation documentation accompanying the system and the rack for specific caution statements and procedures.

- Systems are considered to be components in a rack. Thus, "component" refers to any system as well as to various peripherals or supporting hardware.



CAUTION: Installing systems in a rack without the front and side stabilizers installed could cause the rack to tip over, potentially resulting in bodily injury under certain circumstances. Therefore, always install the stabilizers before installing components in the rack. After installing system/components in a rack, never pull more than one component out of the rack on its slide assemblies at one time. The weight of more than one extended component could cause the rack to tip over and may result in serious injury.

- Before working on the rack, make sure that the stabilizers are secured to the rack, extended to the floor, and that the full weight of the rack rests on the floor. Install front and side stabilizers on a single rack or front stabilizers for joined multiple racks before working on the rack.
- Always load the rack from the bottom up, and load the heaviest item in the rack first.
- Make sure that the rack is level and stable before extending a component from the rack.
- Use caution when pressing the component rail release latches and sliding a component into or out of a rack; the slide rails can pinch your fingers.
- After a component is inserted into the rack, carefully extend the rail into a locking position, and then slide the component into the rack.
- Do not overload the AC supply branch circuit that provides power to the rack. The total rack load should not exceed 80 percent of the branch circuit rating.
- Ensure that proper airflow is provided to components in the rack.
- Do not step on or stand on any component when servicing other components in a rack.



NOTE: A qualified electrician must perform all connections to DC power and to safety grounds. All electrical wiring must comply with applicable local or national codes and practices.



CAUTION: Never defeat the ground conductor or operate the equipment in the absence of a suitably installed ground conductor. Contact the appropriate electrical inspection authority or an electrician if uncertain that suitable grounding is available.



CAUTION: The system chassis must be positively grounded to the rack cabinet frame. Do not attempt to connect power to the system until grounding cables are connected. Completed power and safety ground wiring must be inspected by a qualified electrical inspector. An energy hazard will exist if the safety ground cable is omitted or disconnected.

Protecting Against Electrostatic Discharge

Static electricity can harm delicate components inside the system. To prevent static damage, discharge static electricity from your body before touching any of the electronic components, such as the microprocessor. This can be done by periodically touching an unpainted metal surface on the chassis.

The following steps can also be taken prevent damage from electrostatic discharge (ESD):

1. When unpacking a static-sensitive component from its shipping carton, do not remove the component from the antistatic packing material until ready to install the component in the system. Just before unwrapping the antistatic packaging, be sure to discharge static electricity from your body.
2. When transporting a sensitive component, first place it in an antistatic container or packaging.
3. Handle all sensitive components in a static-safe area. If possible, use antistatic floor pads, workbench pads and an antistatic grounding strap.

Chapter 1 Introduction

Switch Description

Features

Ports

Front-Panel Components

LED Indicators

Rear Panel Components

Side Panel Components

Switch Description

D-Link's DGS-3420 Series is a high performance member of the D-Link xStack® family. Ranging from 10/100/1000 Mbps edge switches to core gigabit switches, the xStack® switch family has been future-proof designed to provide fault tolerance, flexibility, port density, robust security and maximum throughput with a user-friendly management interface for the networking professional.

The Series features the following list of switches:

- **DGS-3420-28SC:** Twenty SFP ports (10/100/1000Mbps), Four Combo Copper/SFP ports (10/100/1000Mbps and 100/1000Mbps), Four SFP+ ports (10GE), Layer 2+ Stackable Managed Switch.
- **DGS-3420-28TC:** Twenty Copper ports (10/100/1000Mbps), Four Combo Copper/SFP ports (10/100/1000Mbps and 100/1000Mbps), Four SFP+ ports (10GE), Layer 2+ Stackable Managed Switch.
- **DGS-3420-26SC:** Twenty SFP ports (10/100/1000Mbps), Four Combo Copper/SFP ports (10/100/1000Mbps and 100/1000Mbps), Two SFP+ ports (10GE), Layer 2+ Stackable Managed Switch.
- **DGS-3420-28PC:** Twenty Copper PoE ports (10/100/1000Mbps), Four Combo Copper/SFP ports (10/100/1000Mbps and 100/1000Mbps), Four SFP+ ports (10GE), Layer 2+ Stackable Managed Switch.
- **DGS-3420-52T:** Fourty-eight Copper ports (10/100/1000Mbps), Four SFP+ ports (10GE), Layer 2+ Stackable Managed Switch.
- **DGS-3420-52P:** Fourty-eight Copper PoE ports (10/100/1000Mbps), Four SFP+ ports (10GE), Layer 2+ Stackable Managed Switch.

This cost effective Gigabit Switch provides an affordable solution for administrators to upgrade their networks to high speed Gigabit connections. The dedicated stacking ports offer up to 40G bi-directional bandwidth, which makes the DGS-3420 Series also suitable as a backbone solution for SMBs. The advanced ACL and user authentication functions on the Switch extend the network security coverage from core to the edge. A unique D-Link Safeguard Engine protects the DGS-3420 Series from the threat of worms and viruses, thereby increasing overall reliability, serviceability, and availability

The Switch has a combination of 1000BASE-T ports and SFP ports that may be used in uplinking various network devices to the Switch, including PCs, hubs and other switches to provide a gigabit Ethernet uplink in full-duplex mode. The SFP (Small Form Factor Portable) combo ports are used with fiber-optical transceiver cabling in order to uplink various other networking devices for a gigabit link that may span great distances.

Features

The list of features below highlights the significant features of the Switch.

- Supports Virtual Stacking. D-Link Single IP Management (SIM).
- Supports Physical Stacking, using the SFP+ ports with 40Gb (Full Duplex) in topologies Linear and Ring.
- Supports a 16K MAC address table.
- Supports Flow Control (802.3x) in full-duplex compliant.
- Supports Jumbo Frames of up to 13Kbytes
- Supports Spanning Tree with 802.1D 2004 STP/RSTP and 802.1Q 2005 MSTP.
- Supports Loopback Detection (LBD).
- Supports Link Aggregation (802.3ad and 802.3AX) with a maximum of 32 groups per Switch.
- Supports Mirroring with RSPAN.
- Supports Layer 2 Protocol Tunneling (L2PT) with tunneling across GVRP and STP.
- Supports Ethernet Ring Protection Switching (ERPS) including Multi-ERPS of up to 12 ERPS rings.
- Supports Layer 2 Multicast Filtering.
- Supports IGMP Snooping (v1/2/3) with up to 960 snooping groups and 64 static multicast addresses and MLD Snooping with up to 480 snooping groups and 64 static multicast addresses. IGMP Snooping and MLD Snooping share 1024 snooping groups.
- Supports IGMP and MLD Proxy.
- Supports Limited IP Multicast (IGMP Filtering).
- Supports Virtual LAN (802.1Q) with up to 4K static VLAN groups and 255 dynamic VLAN groups.
- Supports Port-based and MAC-based VLAN.
- Supports VLAN trunking and Asymmetric VLAN.
- Supports ISM, Private, Subnet-based, Voice, and Double VLAN (Q-in-Q).
- Supports VLAN Translation.
- Supports IP Interfaces with up to 256 IP interfaces.
- Supports Loopback Interface of up to 8 IPv4 interfaces.
- Supports Gratuitous ARP and ARP Proxy.
- Supports IPv6 Tunneling.
- Supports Multiple IP interfaces per VLAN.
- Supports IPv6 Ready Phase 2 compliancy.
- Supports Static and Dynamic Routing.
- Supports Routing Information Protocol (RIP) including RIPv1, RIPv2, and RIPv6.
- Supports Multicast Replication.
- Supports Quality of Service (QoS) with Queue Handling, Class of Service (CoS), Three Color Marking, Bandwidth Control, and Time-based QoS.
- Supports Access Control List (ACL) with Ingress ACL, Egress ACL, Time-based ACL, ACL Statistics, and CPU Interface Filtering.
- Supports Secure Shell (SSHv2) with IPv4/IPv6 access.
- Supports Secure Sockets Layer (SSL) versions 1, 2, and 3 with IPv4/IPv6 access.
- Supports Port Security of up to 3328 MAC addresses for port, system and VLAN.
- Supports Broadcast, Multicast, and Unicast Control.
- Supports Traffic Segmentation
- Supports D-Link SafeGuard Engine.
- Supports BPDU Attack Protection and ARP Spoofing Prevention.
- Supports IP-MAC-Port Binding (IMPB). This feature includes IP Inspection, ARP Inspection, IPv4/IPv6 Address Binding, DHCPv4 Binding, DHCPv6 Binding, and IPv6 ND Snooping.

- Supports DHCP Server Screening and DHCP Client Filtering.
- Supports DoS Attack Prevention.
- Supports Port-based Network Access Control (PNAC) better known as 802.1X. This feature includes Local and RADIUS databasis, Port-based Access Control, and MAC-based Access Control (MAC).
- Supports Web-based Access Control (WAC) that also supports HTTPS.
- Supports Japanese Web-based Access Control (JWAC).
- Supports Network Access Protection (NAP) using 802.1X guest VLAN.
- Supports Guest VLAN.
- Supports 4 Level User Account Priledges called Adminstator, Operator, Power-user, and User.
- Supports Compound Authentication.
- Supports Link Layer Discovery Protocol (LLDP) with LLDP-MED.
- Supports Accessibility using multiple interfaces like the Command Line Interface (CLI), Web-based Graphical User Interface (Web-based GUI), and more.
- Supports Telnet Server and Client from IPv4 and IPv6.
- Supports Trivial File Transfer Protocol (TFTP) Client.
- Supports Simple Network Management Protocol (SNMP) version 1, 2c, and 3. Also supports SNMP Traps.
- Supports sFLOW, BOOTP and DHCP Client.
- Supports Dynamic Host Configuration Protocol (DHCP) Server and Relay.
- Supports Trap, Log, and Alarm Severity Control.
- Support Multiple Images and Multiple Configurations.
- Suports Flash File System using either a FAT16 or FAT32 SD Card.
- Supports Password Encryption and Password Recovery.
- Supports Simple Network Time Protocol (SNTP) with the Precision Time Protocol (PTP).
- Supports Network Load Balancing (NLB) with both IPv4 and IPv6 support.
- Supports Simple Mail Transfer Protocol (SMTP).
- Support Ethernet Link Object Access Method (OAM) using 802.3ah D-Link Unidirectional Link Detection (DULD).
- Supports Connectivity Fault Management (CFM) using 802.1ag.
- Support Power Saving using two methods called Link Status Mode and Cable Length Mode.
- Support Time-based Power-over-Ethernet (PoE).
- Supports Access Authentication Control utilizing TACACS, XTACACS, TACACS+, and RADIUS protocols.
- Supports IEEE 802.3az compliance (Hardware Version :B1).
- Supports MIBs like MIBII, Bridge MIB, SNMPv2 MIB, RMON MIB, RMONv2 MIB, Ether-like MIB, 802.3 MAU MIB, 802.1p MIB, IF MIB, RADIUS Authentication Client MIB, RIPv2 MIB, IP Forwarding Table MIB (CIDR), RADIUS Accounting Client MIB, Ping MIB, Trace out MIB, L2 Specific MIB, L3 Specific MIB, Private MIB, Entity MIB, and ZoneDefense MIB.

Ports

The following table lists the ports that are present within each switch.

DGS-3420-28SC	Twenty SFP ports (100/1000Mbps). Four Combo Copper/SFP ports (10/100/1000Mbps and 100/1000Mbps). Four SFP+ ports (10GE).
DGS-3420-28TC	Twenty Copper ports (10/100/1000Mbps). Four Combo Copper/SFP ports (10/100/1000Mbps and 100/1000Mbps). Four SFP+ ports (10GE).

DGS-3420-26SC	Twenty SFP ports (100/1000Mbps). Four Combo Copper/SFP ports (10/100/1000Mbps and 100/1000Mbps). Two SFP+ ports (10GE).
DGS-3420-28PC	Twenty Copper PoE ports (10/100/1000Mbps). Four Combo Copper/SFP ports (10/100/1000Mbps and 100/1000Mbps). Four SFP+ ports (10GE).
DGS-3420-52T	Forty-eight Copper ports (10/100/1000Mbps). Four SFP+ ports (10GE).
DGS-3420-52P	Forty-eight Copper PoE ports (10/100/1000Mbps). Four SFP+ ports (10GE).

- All the switches are equipt with one RJ-45 Console port (a special console cable with a DB9 interface is provided to connect the Switch to a PC)
- All the switches are equipt with one Redundant Power Supply (RPS) outlet for optional external RPS
- All the switches are also equipt with one Alarm Port and SD Card Slot.



NOTE: For customers interested in D-View, D-Link Corporation's proprietary SNMP management software, go to <http://dview.dlink.com.tw/> and download the software and manual.

Front-Panel Components

The front panel of the DGS-3420 Series consists of a Management and Console port, LED indicators for Power, Console, an Alarm Port, and stacking ID LED's. A separate table below describes LED indicators in more detail.

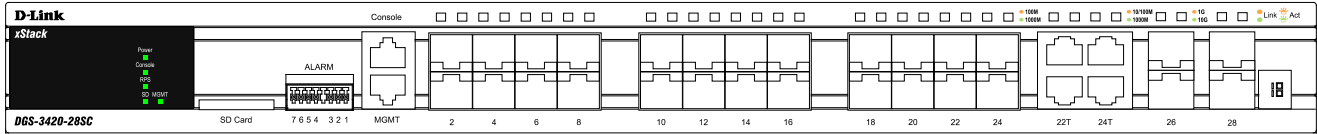

Figure 1- 1. Front panel view of a DGS-3420-28SCSwitch

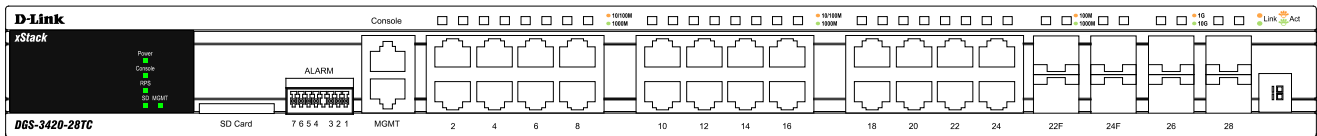

Figure 1- 2. Front panel view of a DGS-3420-28TC Switch

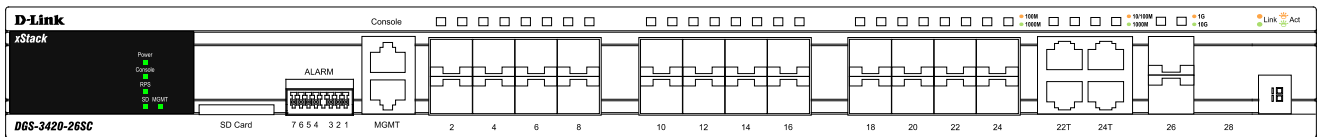

Figure 1- 3. Front panel view of a DGS-3420-26SC Switch

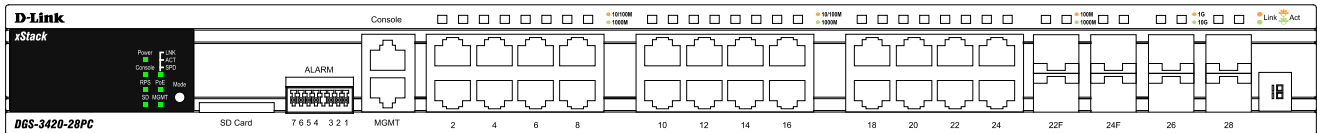

Figure 1- 4. Front panel view of a DGS-3420-28PC Switch

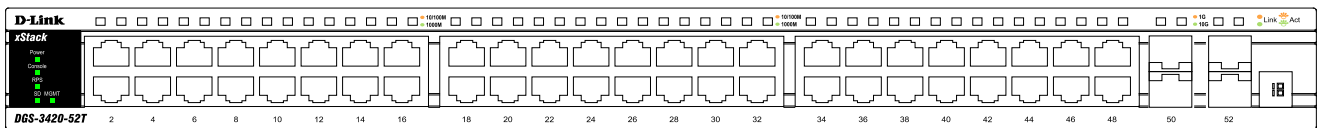

Figure 1- 5. Front panel view of a DGS-3420-52T Switch

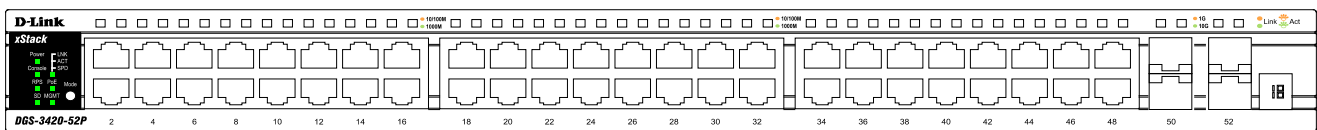

Figure 1- 6. Front panel view of a DGS-3420-52P Switch

LED Indicators

The Switch front panel presents LED indicators for Power, Console, RPS, Master (stack control), SD, Stack ID and Link/Act indicators for all ports including the Gigabit Ethernet ports. The DGS-3420-28PC and DGS-3420-52P switches are equipt with an additional PoE light, to indication whether the ports are running in Power over Ethernet mode.

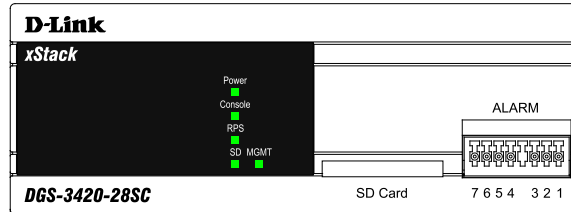

Figure 1- 7. LED indicators for the DGS-3420-28SC

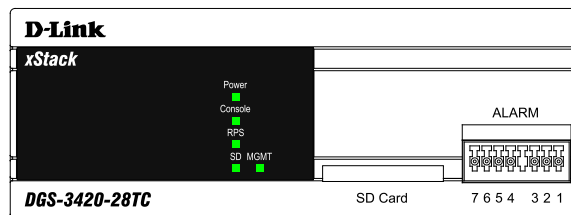

Figure 1- 8. LED indicators for the DGS-3420-28TC

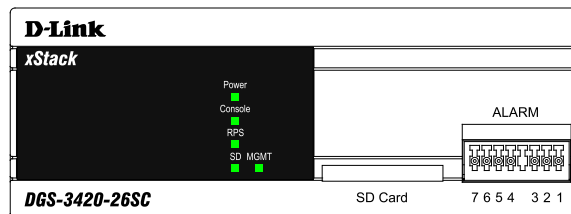

Figure 1- 9. LED indicators for the DGS-3420-26SC

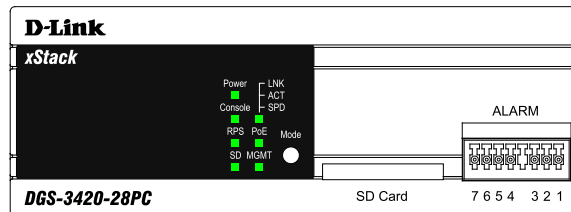

Figure 1- 10. LED indicators for the DGS-3420-28PC

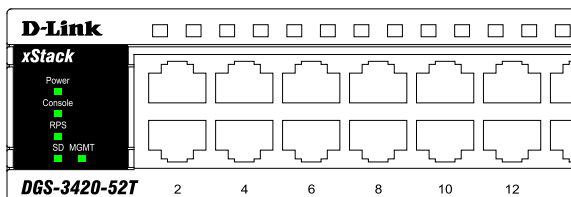

Figure 1- 11. LED indicators for the DGS-3420-52T

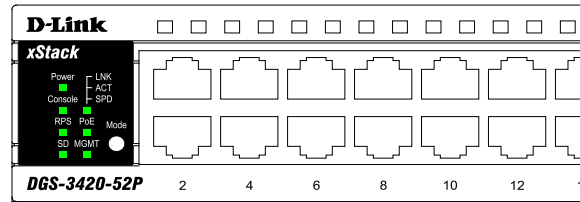

Figure 1- 12. LED indicators for the DGS-3420-52P

LED	Description
Power	This LED will light green after powering the Switch on to indicate the ready state of the device. The indicator is dark when the Switch is no longer receiving power (i.e. powered off).
Console	This LED will blink green during the Power-On Self Test (POST). When the POST is finished, the LED goes dark. The indicator will light steady green when a user is logged in through the console port.
RPS	This LED will light green if the Redundant Powers Supply is in use. If the indicator is off, the RPS is not in use. When the switch detects that the RPS is connected, the light will be blinking.
SD	This LED will light green if a Secure Digital (SD) card is plugged in. When the Switch is reading or writing, the indicator will blink green. No light LED means there is no link. A solid red LED indicates SD card failure.
Stack ID	For standalone Switches, this will display number "1". For stacked Switches, this indicates the position in the stacking box ID. The box ID is assigned either by the user (static mode) or by the system (automatic mode). When "1" to "12" is displayed, this indicates the stacking position of the switch. An "H" indicates the device was assigned as the stacking Master. "h" means the device was selected to be the Backup Master. A "G" is displayed when the Safeguard Engine feature enters the exhausted mode.
Link/Act LEDs	The Switch has LED indicators for Link and Activity. The LED will light steady green when there is a secure connection (or link) to a 1000Mbps Ethernet device at any of the ports, or steady orange when there is a secure connection (or link) to a 10/100Mbps Ethernet device at any of the ports. The LED will blink green when a 1000Mbps port is active, or blink orange when a 10/100Mbps port is active. The LED remains dark when there is no link or activity.
PoE	Only the DGS-3420-28PC and the DGS-3420-52P switches are equipit with a PoE LED. When this light is on with a solid green light, it means that the corresponding ports are feeding power to the PoE devices plugged in. When this light is on with a solid orange light, it means that the port is in an error condition state. When this light is off, it means that the ports are not supplying power to the devices plugged into the ports.

Rear Panel Components

The rear panel contains an AC/DC power connector and an outlet for an external redundant power supply.

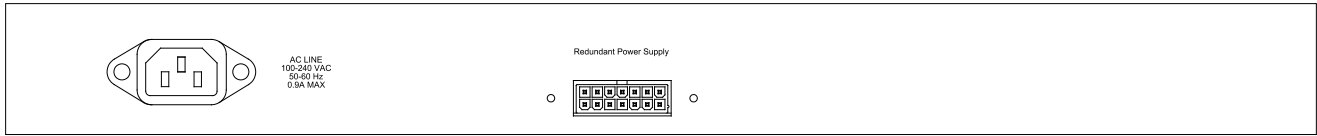

Figure 1- 13. Rear panel view of a DGS-3420-28SC Switch

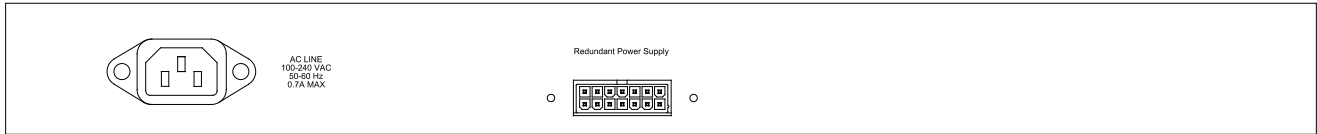

Figure 1- 14. Rear panel view of a DGS-3420-28TC Switch

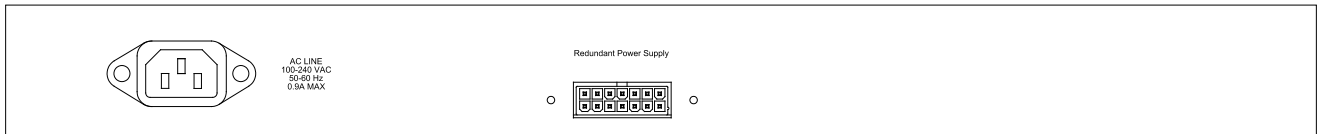

Figure 1- 15. Rear panel view of a DGS-3420-26SC Switch

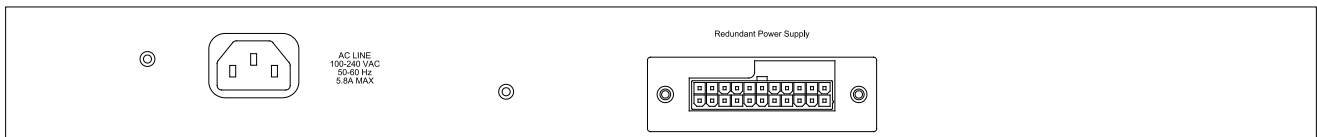

Figure 1- 16. Rear panel view of a DGS-3420-28PC Switch

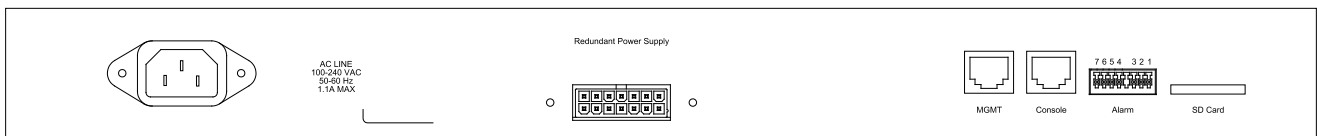

Figure 1- 17. Rear panel view of a DGS-3420-52T Switch

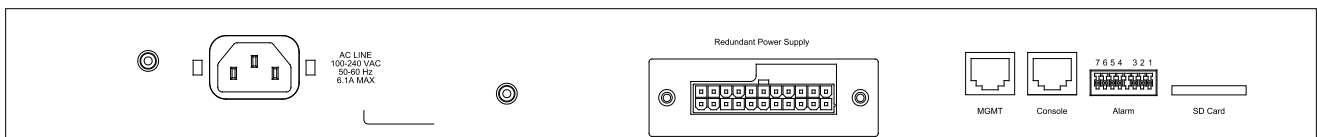

Figure 1- 18. Rear panel view of a DGS-3420-52P Switch

The AC power connector is a standard three-pronged connector that supports the power cord. Plug-in the female connector of the provided power cord into this socket, and the male side of the cord into a power outlet. The Switch automatically adjusts the power setting to any supply voltage in the range from 100~240 VAC at 50~60 Hz. An optional external Redundant Power Supply (DPS-500 for DGS-3420-28TC/28SC/26SC/52T, DPS-700 for DGS-3420-28PC/52P) can be plugged into the RPS outlet displayed above. When the internal power fails, this optional external RPS will take over all the power immediately and automatically.

Side Panel Components

The system heat vents located on each side dissipate heat. Do not block these openings. Leave at least 6 inches of space at the rear and sides of the Switch for proper ventilation. Be reminded that without proper heat dissipation and air circulation, system components might overheat, which could lead to system failure or even severely damage components.

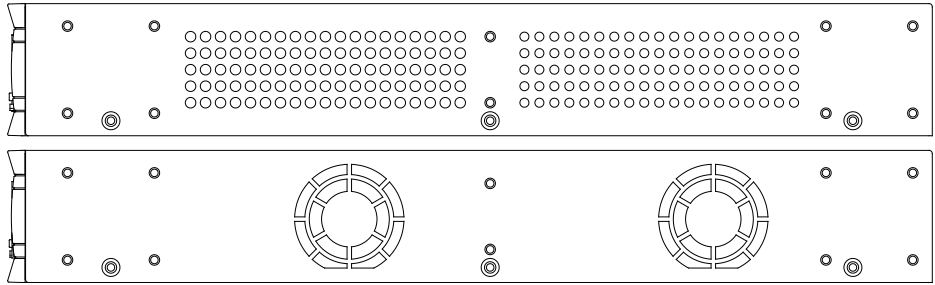

Figure 1- 19. Side panels of the DGS-3420-28SC Switch

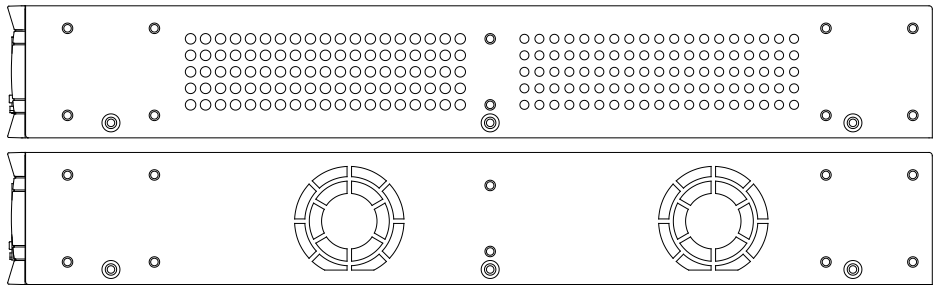

Figure 1- 20. Side panels of the DGS-3420-28TC Switch

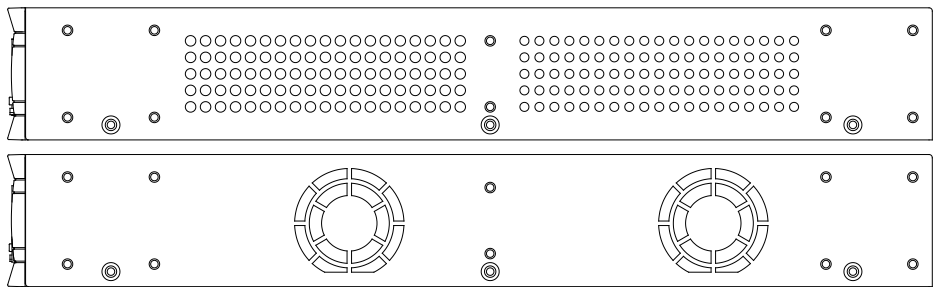

Figure 1- 21. Side panels of the DGS-3420-26SC Switch

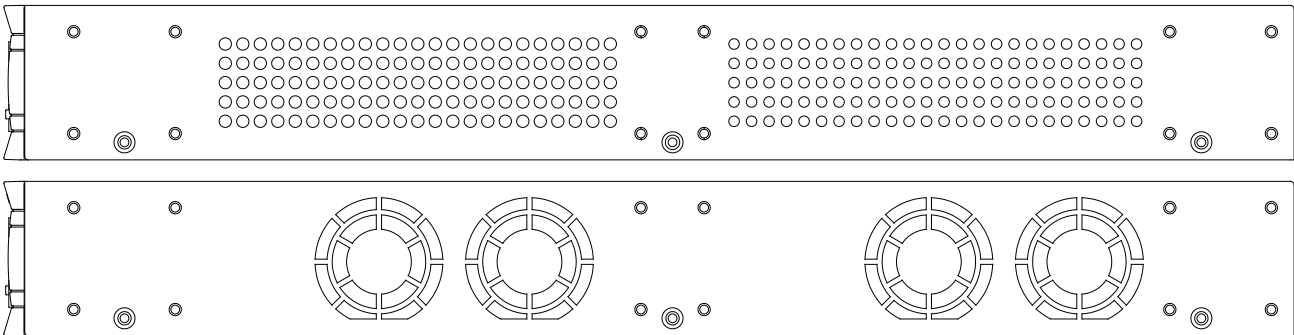

Figure 1- 22. Side panels of the DGS-3420-28PC Switch

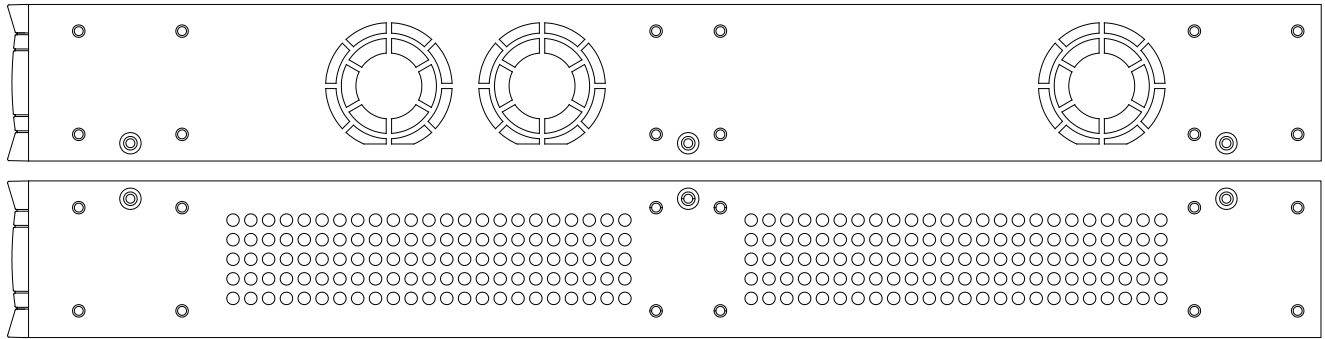

Figure 1- 23. Side panels of the DGS-3420-52T Switch

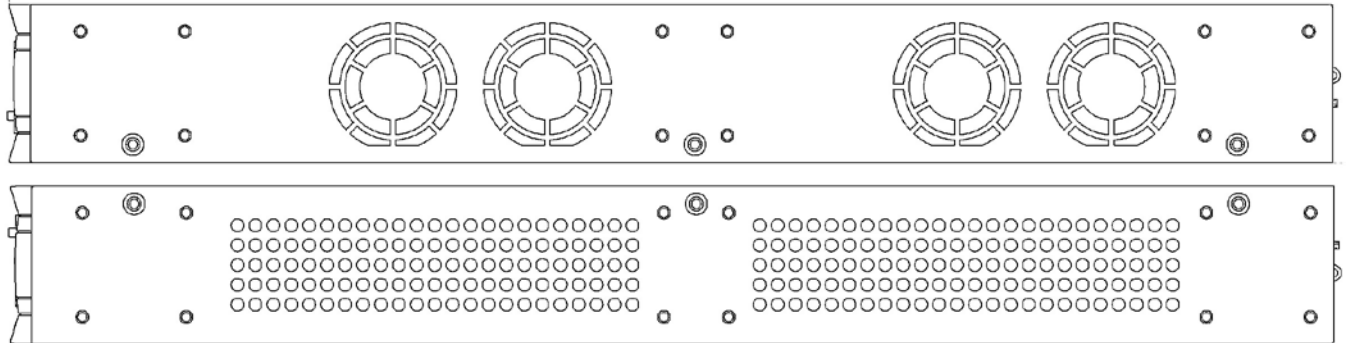

Figure 1- 24. Side panels of the DGS-3420-52P Switch

Chapter 2 Installation

Package Contents

Installation Guidelines

Power On (AC Power)

Alarm Connector

Installing SFP and SFP+ Ports

Connecting to a Redundant Power Supply

External Redundant Power System

Package Contents

Open the shipping carton of the Switch and carefully unpack its contents. The carton should contain the following items:

- One DGS-3420 Series Switch
- One AC power cord
- One RJ-45 to RS-232 console cable
- One mounting kit (two brackets and screws)
- Four rubber feet with adhesive backing
- One CD kit for CLI reference guide/Web UI reference guide/Hardware Installation Guide/D-View module

If any item is missing or damaged, please contact your local D-Link Reseller for replacement.

Installation Guidelines

Please follow these guidelines for setting up the Switch:

- Install the Switch on a sturdy, level surface that can support at least 6.6 lb. (3kg – This is without PoE functionality) of weight. Do not place heavy objects on the Switch.
- The power outlet should be within 1.82 meters (6 feet) of the Switch.
- Visually inspect the power cord and see that it is fully secured to the AC power port.
- Make sure that there is proper heat dissipation from and adequate ventilation around the Switch. Leave at least 10 cm (4 inches) of space at the front and rear of the Switch for ventilation.
- Install the Switch in a fairly cool and dry place for the acceptable temperature and humidity operating ranges.
- Install the Switch in a site free from strong electromagnetic field generators (such as motors), vibration, dust, and direct exposure to sunlight.
- When installing the Switch on a level surface, attach the rubber feet to the bottom of the device. The rubber feet cushion the Switch, protect the casing from scratches and prevent it from scratching other surfaces.

Installing the Switch without a Rack

First, attach the rubber feet included with the Switch if installing on a desktop or shelf. Attach these cushioning feet on the bottom at each corner of the device. Allow enough ventilation space between the Switch and any other objects in the vicinity.

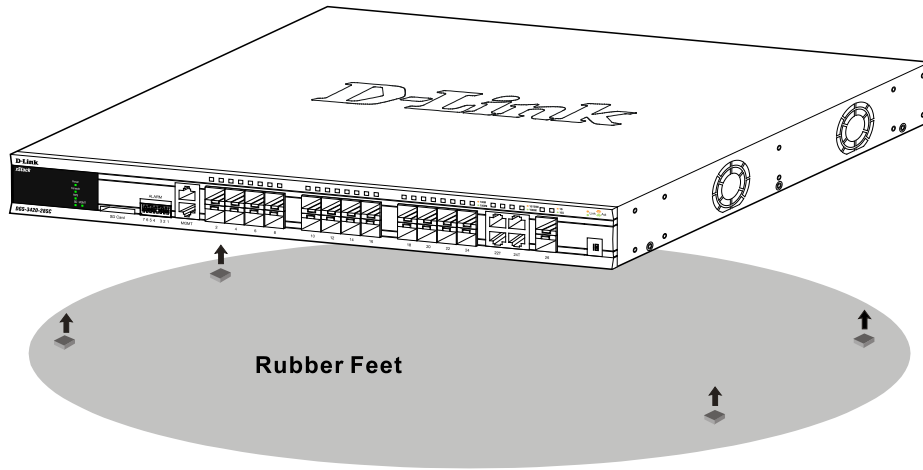

Figure 2-1 Attach rubber feet to the switch.

Attaching Brackets to a Switch for Rack Mounting

The Switch is mounted to a standard 19" rack using mounting brackets. Use the following diagrams as a guide.

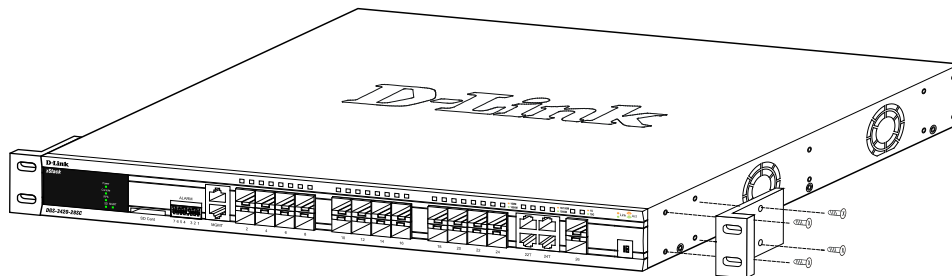

Figure 2-2 Attach mounting brackets to the switch

Fasten the mounting brackets to the Switch using the screws provided. With the brackets attached securely, the Switch can be mounted in a standard rack, as shown below.



NOTE: Please review the Installation Guidelines above before installing the Switch in a rack. Make sure there is adequate space around the Switch to allow for proper air flow, ventilation and cooling.

Mounting the Switch in a Standard 19" Rack

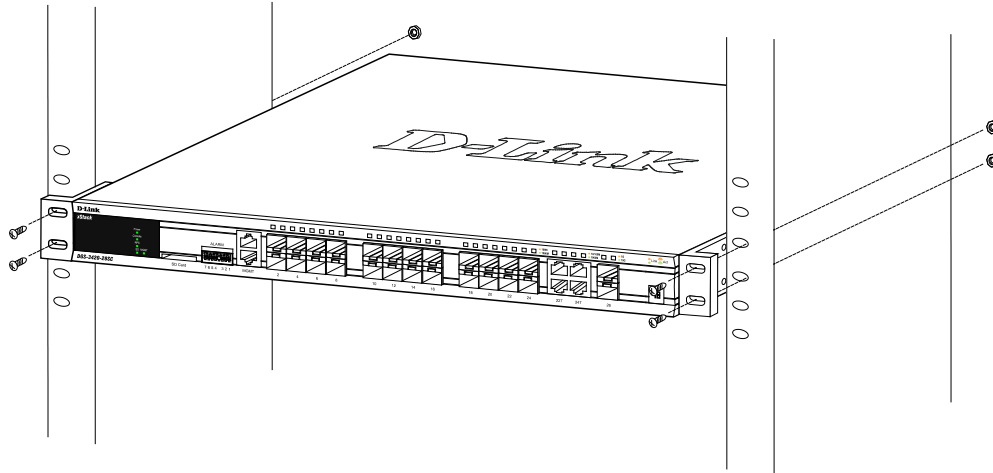

Figure 2-3 Mount the switch in a rack

Power On (AC Power)

1. Plug one end of the AC power cord into the power connector of the Switch and the other end into the local power source outlet.
2. Once the system is powered on, the LED's blink green to indicate that the system is resetting.

Power Failure (AC Power)

In the event of a power failure, just as a precaution, unplug the Switch. After the power returns, plug the switch back in to the power socket.



CAUTION: Installing systems in a rack without the front and side stabilizers installed could cause the rack to tip over, potentially resulting in bodily injury under certain circumstances. Therefore, always install the stabilizers before installing components in the rack. After installing components in a rack, do not pull more than one component out of the rack on its slide assemblies at one time. The weight of more than one extended component could cause the rack to tip over and may result in injury.

Alarm Connector

The alarm connector can be used to use external devices when triggered events occur.

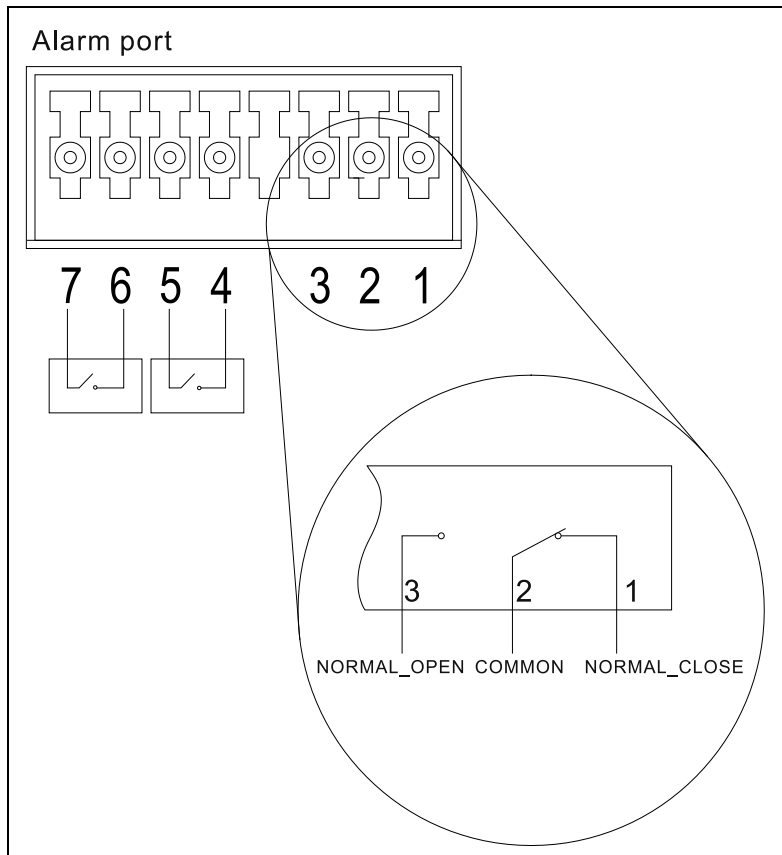

Figure 2-4 Alarm Connector

Alarm Connector Port	
Contact	Description
1	Output. Normal Closed Pin. (42VAC or 60VDC)
2	Output. Common Pin. (42VAC or 60VDC)
3	Output. Normal Open Pin. (42VAC or 60VDC)
4	Input 2
5	Input 2
6	Input 1
7	Input 1

Connect the alarm input pins to alarm output terminals on other pieces of equipment.
 Connect the alarm output pins to alarm input terminals on other pieces of equipment.

Installing SFP and SFP+ Ports

The Switch is equipped with SFP (Small Form Factor Portable) and SFP+ ports, which are used with fiber-optical transceiver cabling. SFP ports support full-duplex transmissions, auto-negotiation, and can be uplinked with various other switches across a gigabit network. The SFP ports support data rates of up to 1Gb/s and the SFP+ ports support data rates of up to 10Gb/s.

See the figure below for installing the SFP ports in the Switch.

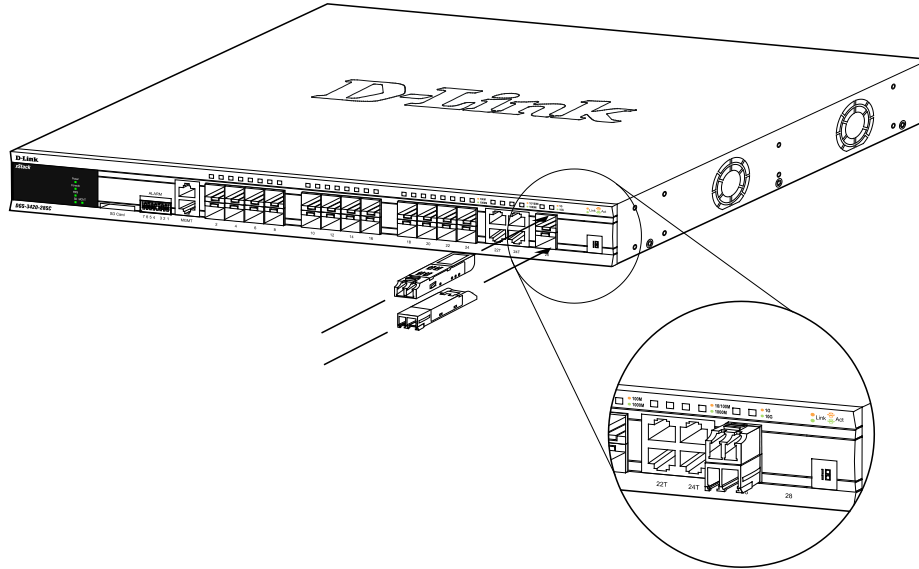

Figure 2-5 Inserting fiber-optic transceivers into a DGS-3420 Series Switch

For a full list of supported transceivers compatible with this switch series, refer to Port Functions [on page 43](#).

Connecting to a Redundant Power Supply

The Switch connects to the Master Switch using a 14-pin DC power cable. A standard, three-pronged AC power cable connects the redundant power supply to the main power source.

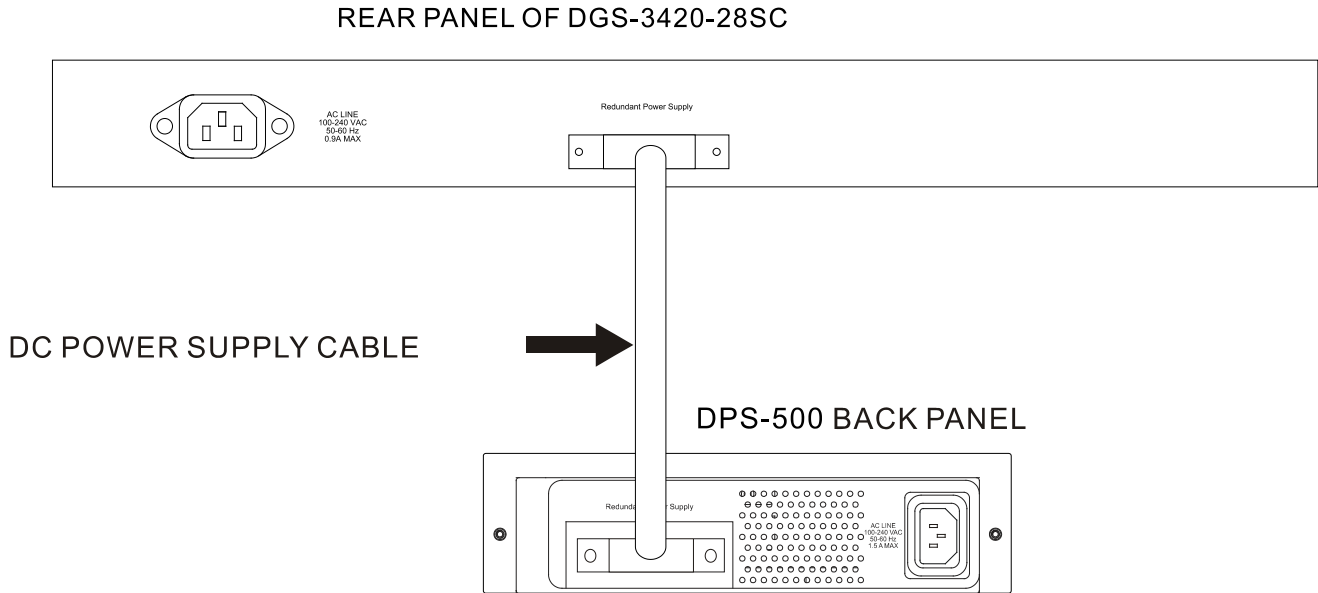

Figure 2-6 Connecting a DGS-3420 Series Switch to the DPS-500 (28TC, 28SC, 26SC, and 52T)

1. Insert one end of the 14-pin DC power cable into the port on the switch and the other end into the redundant power supply.
2. Using a standard AC power cable, connect the redundant power supply to the main AC power source. A green LED on the front of the DPS-500 will glow to indicate a successful connection.
3. Re-connect the switch to the AC power source. The LED indicator will show that a redundant power supply is now in operation.
4. Do not make any changes on the switch.



NOTE: See the DPS-500 documentation for more information.



CAUTION: Only the DGS-3420-28TC, DGS-3420-28SC, DGS-3420-26SC, and the DGS-3420-52T use the DPS-500. The DGS-3420-28PC and the DGS-3420-52P use the DPS-700.

External Redundant Power System

The DPS-500/700 is a redundant power-supply unit designed to conform to the voltage requirements of the switches being supported. The DPS-500/700 can be installed into a DPS-900, or DPS-800 rack mount unit.



CAUTION: DO NOT connect the RPS to AC power before the DC power cable is connected. This might damage the internal power supply.

DPS-900

The DPS-900 is a standard-size rack mount (5 standard units in height) designed to hold up to eight DPS-500 redundant power supplies. However, it cannot hold eight DGS-700 modules.

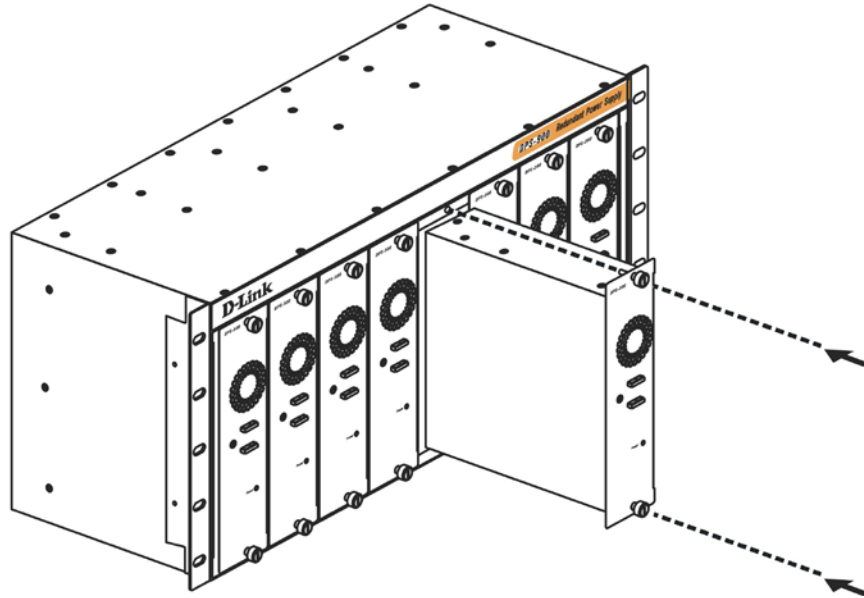

Figure 2-7 Inserting the DPS-500 into the DPS-900

The RPS can be mounted in a standard 19" rack. Use the following diagram to guide you.

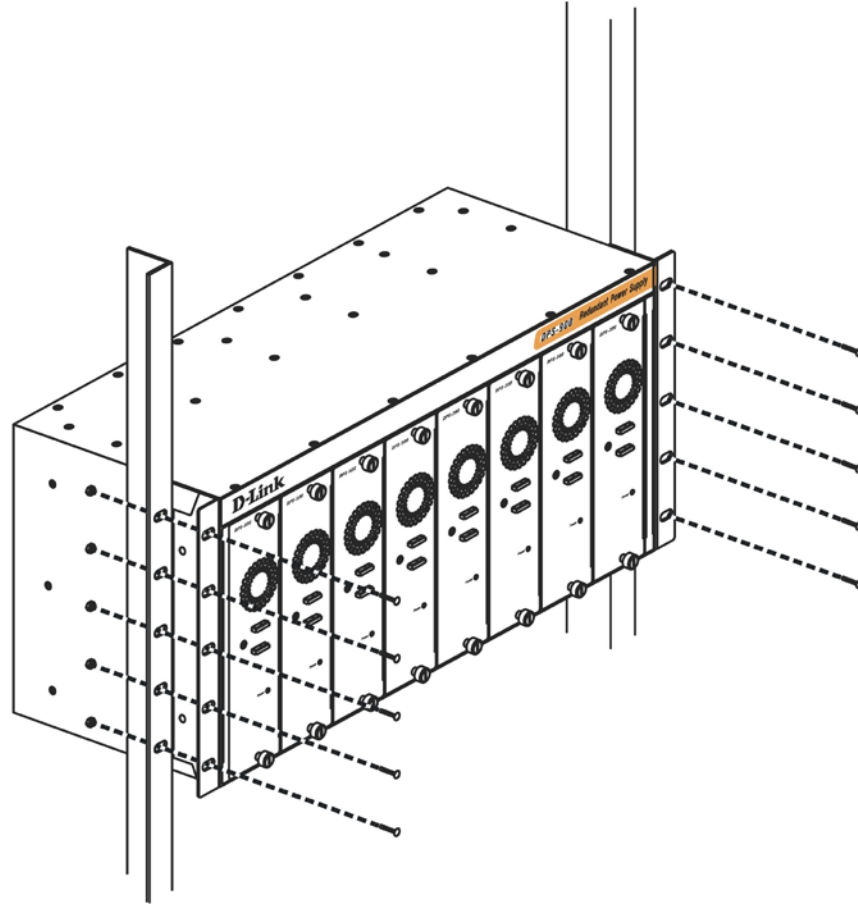

Figure 2-8 Install the DPS-900 into the equipment rack



CAUTION: Installing systems in a rack without the front and side stabilizers installed could cause the rack to tip over, potentially resulting in bodily injury under certain circumstances. Therefore, always install the stabilizers before installing components in the rack. After installing components in a rack, do not pull more than one component out of the rack on its slide assembly at a time. The weight of more than one extended component could cause the rack to tip over and may result in injury.

DPS-800

The DPS-800 is a standard-size rack mount (1 standard unit in height) designed to hold up to two DPS-200, DPS-300 and DPS-500 redundant power supplies.

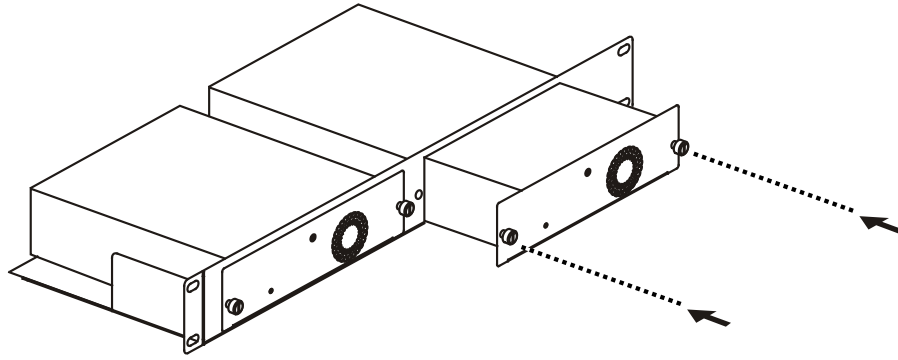

Figure 2-9 Install the DPS-500 in the DPS-800

The RPS can be mounted in a standard 19" rack. Use the following diagram to guide you.

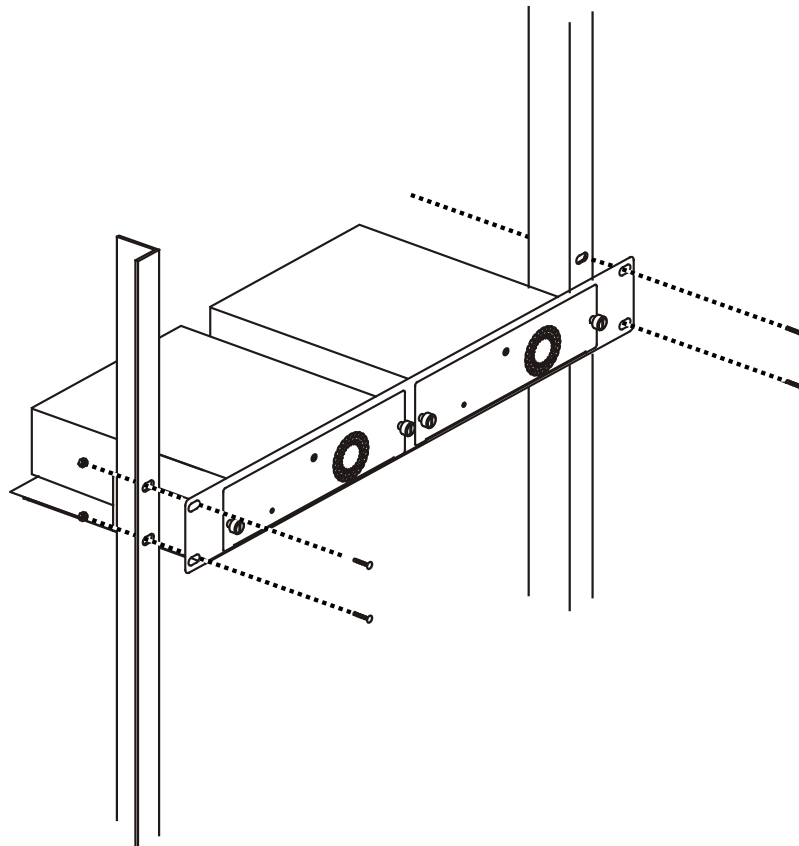

Figure 2-10 Install the DPS-800 in an Equipment Rack

Chapter 3 Connecting the Switch

Switch to End Node

Switch to Switch

Connecting To Network Backbone or Server

Switch to End Node

End nodes include PCs outfitted with a 10/100/1000Mbps RJ-45 Ethernet Network Interface Card (NIC) and routers. An end node connects to the Switch via a twisted-pair UTP/STP cable. Connect the end node to any of the 1000BASE-T ports of the Switch. The Link/Act LEDs for each Ethernet port turns green or amber when the link is active. A blinking LED indicates packet activity on that port.

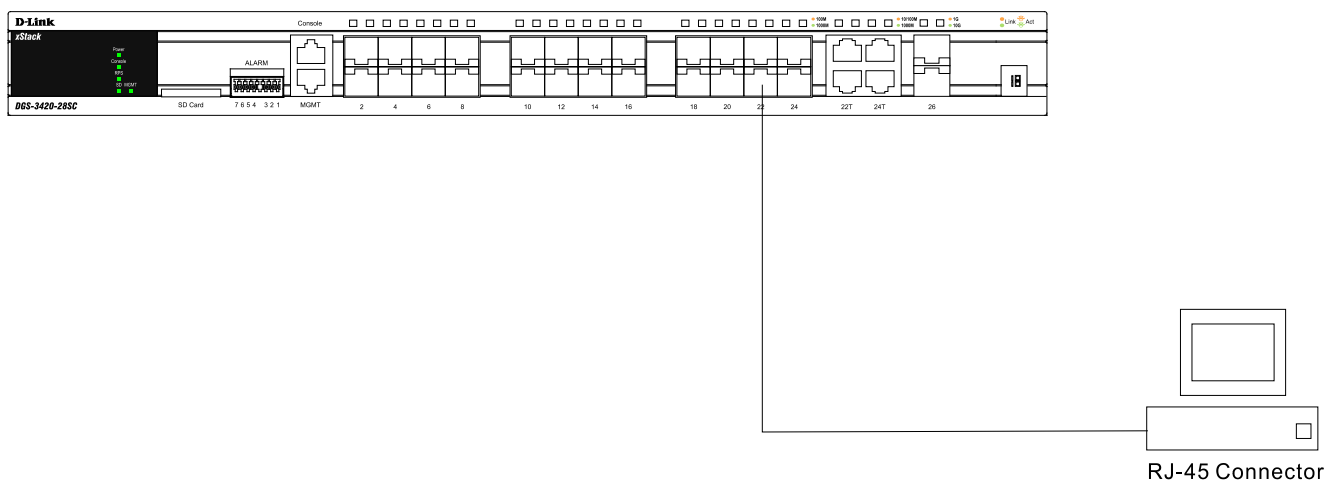

Figure 3–1 Connect a DGS-3420 Series Switch to an end node



NOTE: All high-performance N-Way Ethernet ports can support both MDI-II and MDI-X connections.

Switch to Switch

There is a great deal of flexibility on how connections are made using the appropriate cabling.

- Connect a 10BASE-T switch port to the Switch via a twisted-pair Category 3, 4 or 5 UTP/STP cable.
- Connect a 100BASE-TX switch port to the Switch via a twisted-pair Category 5 UTP/STP cable.
- Connect 1000BASE-T switch port to the Switch via a twisted pair Category 5e UTP/STP cable.
- Connect switch supporting a fiber-optic uplink to the Switch's SFP ports via fiber-optic cabling. See cabling guidelines in Appendix B for more information.

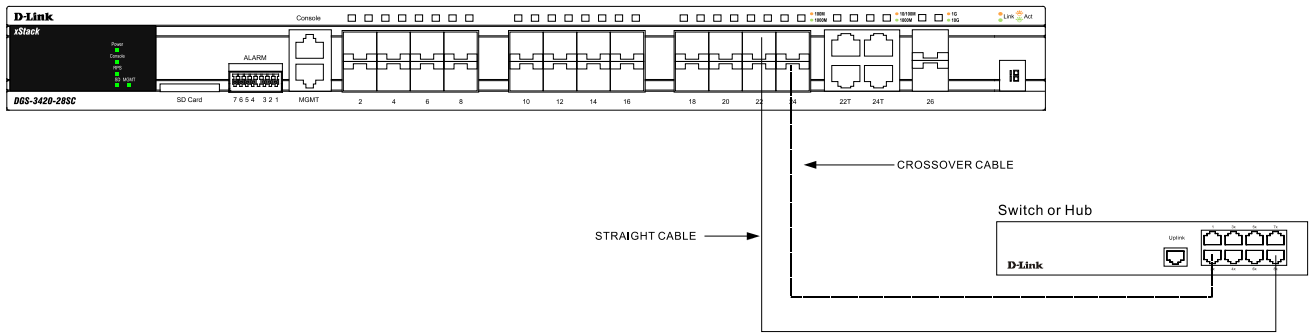

Figure 3–2 Connect the Switch to a port on a switch with a straight or crossover cable

Connect to a Network Backbone or Server

The combo SFP ports and the 1000BASE-T ports are ideal for uplinking to a network backbone, server or server farm. The copper ports operate at a speed of 10/100/1000Mbps in half or full duplex mode. The fiber-optic ports can operate at both 100Mbps and 1000Mbps in full duplex mode.

You can connect to the Gigabit Ethernet ports using a fiber-optic cable or a Category 5E copper cable, depending on the type of port. The Link LED turns green when a connection is made.

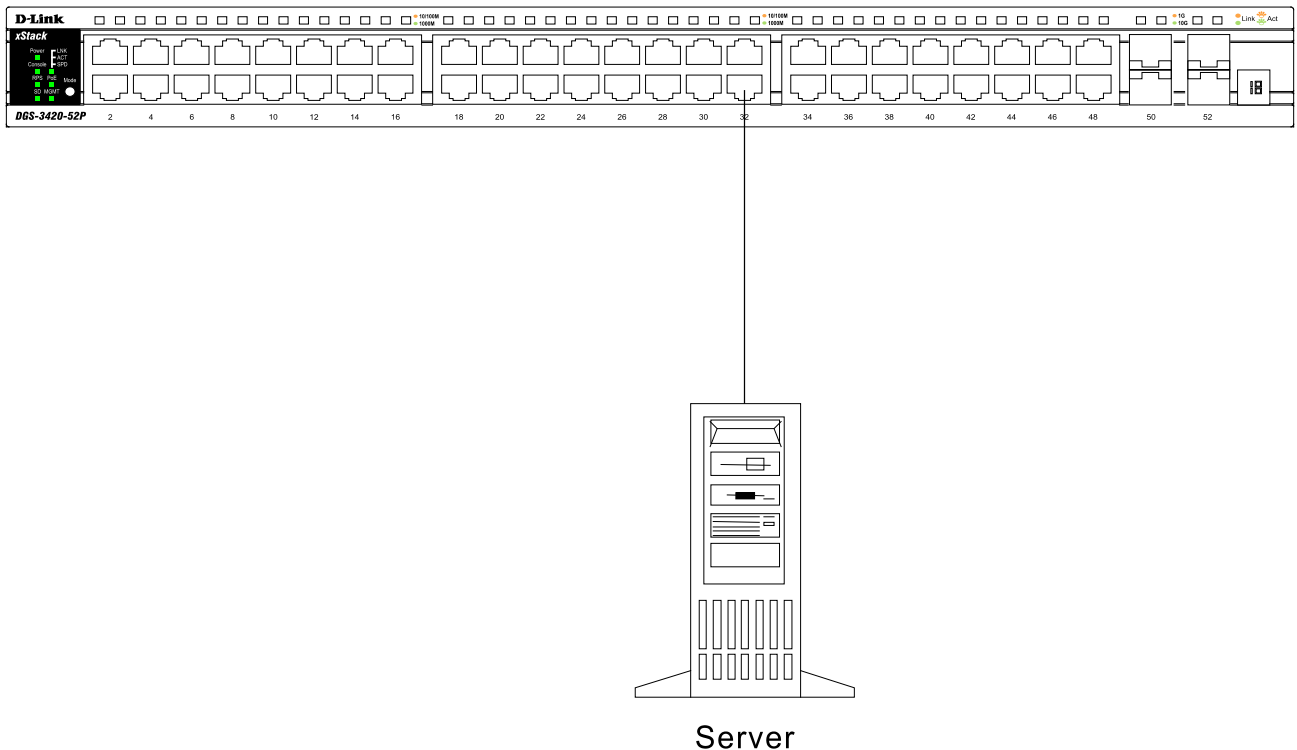

Figure 3–3 Connect a DGS-3420 Series Switch to a server

Chapter 4 Introduction to Switch Management

Management Options

Connecting the Console Port

Connecting to the Switch for the first time

Connecting to the Management Port

Password Protection

Assigning IP Addresses

SNMP Settings

Management Options

This system may be managed out-of-band through the console port on the front panel or in-band using Telnet. The user may also choose the web-based management, accessible through a web browser.

Web-based Management Interface

After successfully installing the Switch, the user can configure the Switch, monitor the LED panel, and display statistics graphically using a Web browser, such as Microsoft® Internet Explorer (version 5.5 and later), Netscape (version 8 and later), Mozilla Firefox (version 2.0 and later), Safari (version 4.0 and later), and Google Chrome (version 6.0 and later).

SNMP-Based Management

The Switch is also managed with an SNMP-compatible console program. It supports SNMP version 1.0, 2.0 and 3.0. The SNMP agent decodes the incoming SNMP messages and responds to requests with MIB objects stored in the database. The SNMP agent updates the MIB objects to generate statistics and counters.

Command Line Interface Management through the Serial Port or remote Telnet

The user can also connect a computer or terminal to the serial console port to access the DGS-3420 range. The command line interface provides complete access to all DGS-3420 Series of switches management features.

Connecting the Console Port

The console port on the front panel of the Switch is used to connect a computer that monitors and configures the switch. The console port is an RJ-45 port and requires a special cable that is included with the switch, to establish the physical connection.

To use the console port, the following equipment is needed:

- A terminal or a computer with both an RS-232 serial port and the ability to emulate a terminal.
- A console cable with a male DB-9 connector on one end and an RJ-45 connection on the other. This cable should be included with any of the DGS-3420 Series. It establishes the physical connection to the console port.

To connect a terminal to the console port:

Connect the male DB-9 connector on the console cable (shipped with the DGS-3420-28SC for example) to the RS-232 serial port on the computer running terminal emulation software then insert the RJ-45 connector into the RJ-45 console port on the front of the switch. Set the terminal emulation software as follows:

- Select the appropriate serial port (COM port 1 or COM port 2).
- Set the data rate to 115200 baud.
- Set the data format to 8 data bits, 1 stop bit, and no parity.
- Set flow control to None.
- Under Properties, select VT100 for Emulation mode.

- Select Terminal keys for Function, Arrow and Ctrl keys. Make sure to use Terminal keys (not Windows keys) are selected.



NOTE: When using HyperTerminal with the Microsoft® Windows® 2000 operating system, ensure that Windows 2000 Service Pack 2 or later is installed. Windows 2000 Service Pack 2 allows the use of arrow keys in HyperTerminal's VT100 emulation. See www.microsoft.com for information on Windows 2000 service packs.

- After you have correctly set up the terminal, plug the power cable into the power socket on the back of the DGS-3420 Series switch. The boot sequence appears in the terminal.
- After the boot sequence completes, the console login screen displays.
- If the user has not logged into the command line interface (CLI) program, press the Enter key at the User name and password prompts. There is no default user name and password for the Switch. The administrator must first create user names and passwords. If user accounts have been previously set up, log in and continue to configure the Switch.
- Enter the commands to complete desired tasks. Many commands require administrator-level access privileges. Read the next section for more information on setting up user accounts. See the **DGS-3420 Series CLI Reference Guide** on the documentation CD for a list of all commands and additional information on using the CLI.
- To end a management session, use the logout command or close the emulator program.

If you experience problems while making a connection, make sure the emulation is set to VT-100. The emulation settings can be configured by:

1. Click File Menu in HyperTerminal
2. Click Properties from the drop-down menu
3. Click the Settings Tab

This is where you will find the Emulation options. If you still do not see anything, try rebooting the Switch by disconnecting its power supply.

Once connected to the console, the following image appears. This is where the user will enter commands to perform all the available management functions. The Switch will prompt the user to enter a user name and password. Logging on at the beginning requires no username or password. Just press the Enter key twice to access the command line interface.

```

Boot Procedure                                     V1.00.003
-----
Power On Self Test ..... 100 %

MAC Address   : 00-01-02-03-04-00
H/W Version   : B1

Please Wait, Loading V1.50.010 Runtime Image ..... 100 %
UART init ..... 100 %
Starting runtime image
Device Discovery ..... 100 %
Configuration init ..... 100 %
    
```

Figure 4-1 Boot up display in console screen

Connecting to the Switch for the first time

The Switch supports user-based security that prevents unauthorized users from accessing the switch or changing its settings. This section explains how to log into the DGS-3420 Series Switch from an out-of-band Management port connection.

Once you have connected to the Switch, the following screen appears:

```
DGS-3420-28SC Gigabit Ethernet Switch
Command Line Interface

Firmware: Build 1.50.010
Copyright(C) 2013 D-Link Corporation. All rights reserved.

UserName:
```

Figure 4–2 Initial screen, first time connecting to the Switch

Press **Enter** in both the Username and Password fields. Then access will be given to enter commands after the command prompt **DGS-3420-28SC:admin#**

There is no initial username or password. Leave the Username and Password fields blank.



NOTE: The first user automatically gets Administrator level privileges. At least one Admin-level user account must be created for the Switch.

Connecting to the Management Port

The front panel of the Switch features an out-of-band RJ-45 Management port which can easily connect to a notebook. Connect to the out-of-band management console using a web browser or Telnet command prompt interface. This is the default login interface, and is the tool you can use when connecting to the Switch for the first time.

To use the Management port, connect one end of an Ethernet cable to a computer and the other to the switch. The default IP address of the Management port is 192.168.0.1, and a subnet mask of 255.255.255.0. Make sure that the computer being used for Switch management has a nonconflicting IP address in the 192.168.0.x subnet.

The IP settings or enabled status of the Management port can be changed through the console port, or through the web-based Switch management interface. To change the configuration of the Management port, use the command:

```
config out_band_ipif {ipaddress <network_address> | state [enable | disable] | gateway <ipaddr>}
```

To view the status or IP settings, use the command:

```
show out_band_ipif
```

To change settings for the out-of-band Management port in the web interface, use the following path:

Management > Out of Band Management Settings

Password Protection

The DGS-3420 Series Switches do not have a default user name and password. One of the first tasks when setting up the Switch is to create user accounts. Logging in using a predefined administrator-level user name will give the user privileged access to the Switch's management software.

After the initial login, define new passwords for both default user names to prevent unauthorized access to the Switch, and record the passwords for future reference.

To create an administrator-level account for the Switch, do the following:

1. At the CLI login prompt, enter **create account admin** followed by the <username> and press the Enter key.
2. The Switch will then prompt the user to provide a password. Type the administrator <password> and press the Enter key.
3. Once entered, the Switch will again ask the user to insert the same password again to verify it. Type the same password and press the Enter key.
4. A new administrative account is created once the "Success" prompt appears.



NOTE: Passwords are case sensitive. User names and passwords can be up to 15 characters in length.

The sample below illustrates a successful creation of a new administrator-level account with the user name "newmanager".

```
DGS-3420-28SC:admin# create account admin newmanager
Command: create account admin newmanager

Enter a case-sensitive new password:*****
Enter the new password again for confirmation:*****
Success.

DGS-3420-28SC:admin#
```

Figure 4-3 Create account command



NOTICE: CLI configuration commands only modify the running configuration file and are not saved when the Switch is rebooted. To save all your configuration changes in nonvolatile storage, you must use the save command to copy the running configuration file to the startup configuration.

Assigning IP Addresses

Each Switch must be assigned its own IP Address, which is used for communication with an SNMP network manager or other TCP/IP application (for example BOOTP, TFTP). The Switch's default IP address is 10.90.90.90. You can change the default Switch IP address to meet the specification of your networking address scheme.

The Switch is also assigned a unique MAC address by the factory. This MAC address cannot be changed, and can be found by entering the command `show switch` into the command line interface, as shown below.

```

DGS-3420-28SC:admin#show switch
Command: show switch

Device Type           : DGS-3420-28SC Gigabit Ethernet Switch
MAC Address           : 00-01-02-03-04-00
IP Address            : 10.90.90.90 (Manual)
VLAN Name             : default
Subnet Mask           : 255.0.0.0
Default Gateway       : 0.0.0.0
Boot PROM Version     : Build 1.00.003
Firmware Version      : Build 1.50.010
Hardware Version      : B1
System Name           :
System Location       :
System Uptime         : 0 days, 0 hours, 21 minutes, 21 seconds
System Contact        :
Spanning Tree         : Disabled
GVRP                  : Disabled
IGMP Snooping        : Disabled
MLD Snooping         : Disabled
RIP                   : Disabled
RIPng                 : Disabled
VLAN Trunk            : Disabled
Telnet                : Enabled (TCP 23)
Web                   : Enabled (TCP 80)
CTRL+C ESC q Quit SPACE n Next Page ENTER Next Entry a All

```

Figure 4-4 Show switch command

The Switch's MAC address can also be found from the Web management program on the **System Information window** in the Configuration folder.

The IP address for the Switch must be set before it can be managed with the Web-based manager. The Switch IP address can be automatically set using BOOTP or DHCP protocols, in which case the actual address assigned to the Switch must be known.

The IP address may be set using the Command Line Interface (CLI) over the console serial port as follows:

Starting at the command line prompt, enter the commands

```
config ipif System ipaddress xxx.xxx.xxx.xxx/yyy.yyy.yyy.yyy
```

Where the x's represent the IP address to be assigned to the IP interface named System and the y's represent the corresponding subnet mask.

Alternatively, you can enter `config ipif System ipaddress xxx.xxx.xxx.xxx/z`. Where the x's represent the IP address to be assigned to the IP interface named System and the z represents the corresponding number of subnets in CIDR notation.

The IP interface named System on the Switch can be assigned an IP address and subnet mask, and then be used to connect a management station to the Switch's Telnet or Web-based management agent.

```
DGS-3420-28SC:admin# config ipif System ipaddress 10.90.90.91/255.0.0.0
Command: config ipif System ipaddress 10.90.90.91/8

Success.

DGS-3420-28SC:admin#
```

Figure 4-5 Assigning the Switch an IP Address

In the above example, the Switch was assigned an IP address of 10.90.90.91 with a subnet mask of 255.0.0.0. (the CIDR form was used to set the address (10.90.90.91/8). The system message Success indicates that the command was executed successfully. The Switch can now be configured and managed via Telnet and the CLI or via the Web-based management.

SNMP Settings

Simple Network Management Protocol (SNMP) is an OSI Layer 7 (Application Layer) designed specifically for managing and monitoring network devices. SNMP enables network management stations to read and modify the settings of gateways, routers, switches and other network devices. Use SNMP to configure system features for proper operation, monitor performance and detect potential problems in the Switch, switch group or network.

Managed devices that support SNMP include software (referred to as an agent), which runs locally on the device. A defined set of variables (managed objects) is maintained by the SNMP agent and used to manage the device. These objects are defined in a Management Information Base (MIB), which provides a standard presentation of the information controlled by the on-board SNMP agent. SNMP defines both the format of the MIB specifications and the protocol used to access this information over the network.

The Switch supports SNMP versions 1, 2c, and 3. The administrator may specify which SNMP version to use to monitor and control the Switch. The three SNMP versions vary in the level of security provided between the management station and the network device.

In SNMP v1 and v2, user authentication is accomplished using 'community strings', which function like passwords. The remote user SNMP application and the Switch SNMP must use the same community string. SNMP packets from any station that has not been authenticated are ignored (dropped).

The default community strings for the Switch used for SNMP v1 and v2 management access are:

- public - Allows authorized management stations to retrieve MIB objects.
- private - Allows authorized management stations to retrieve and modify MIB objects.

SNMP v3 uses a more sophisticated authentication process that is separated into two parts. The first part is to maintain a list of users and their attributes that are allowed to act as SNMP managers. The second part describes what each user on that list can do as an SNMP manager.

The Switch allows groups of users to be listed and configured with a shared set of privileges. The SNMP version may also be set for a listed group of SNMP managers. Thus, a group of SNMP managers can be created to view read-only information or receive traps using SNMP v1 while assigning a higher level of security to another group, granting read/write privileges using SNMP v3.

Using SNMP v3 individual users or groups of SNMP managers can be allowed to perform or be restricted from performing specific SNMP management functions. The functions allowed or restricted are defined using the Object Identifier (OID) associated with a specific MIB. An additional layer of security is available for SNMP v3 in that SNMP messages may be encrypted. To read more about how to configure SNMP v3 settings for the Switch read the section entitled Management.

Traps

Traps are messages that alert network personnel of events that occur on the Switch. The events can be as serious as a reboot (someone accidentally turned OFF the Switch), or less serious like a port status change. The Switch generates traps and sends them to the trap recipient (or network manager). Typical traps include trap messages for Authentication Failure, Topology Change and Broadcast\Multicast Storm.

Management Information Base (MIB)

The Switch in the Management Information Base (MIB) stores management and counter information. The Switch uses the standard MIB-II Management Information Base module. Consequently, values for MIB objects can be retrieved from any SNMP-based network management software. In addition to the standard MIB-II, the Switch also supports its own proprietary enterprise MIB as an extended Management Information Base. The proprietary MIB may also be retrieved by specifying the MIB Object Identifier. MIB values can be either read-only or read-write.

Chapter 5 Web-based Switch Configuration

Introduction

Logging onto the Web Manager

Web-based User Interface

Web Pages

Introduction

Most software functions of the Switch can be managed, configured, and monitored via the embedded Web-based (HTML) interface. Manage the Switch from remote stations anywhere on the network through a standard browser, such as Internet Explorer (version 5.5 and later), Netscape (version 8.0 and later), Mozilla Firefox (version 2.0 and later), or Safari (version 4.0 and later). The browser acts as a universal access tool and can communicate directly with the Switch using the HTTP protocol.

Logging onto the Web Manager

To begin managing the Switch, simply run the browser installed on your computer and point it to the IP address you have defined for the device. The URL in the address bar should read something like: `http://123.123.123.123`, where the numbers 123 represent the IP address of the Switch.



NOTE: The factory default IP address, for a normal port, is 10.90.90.90. The factory default IP address, for the management port, is 192.168.0.1.

The Web User Interface's authentication window can be accessed using the IP address of 10.90.90.90 (normal port), as seen below.



Figure 5–1 Enter Network Password Window

Leave the User Name field and the Password field blank and click **OK**. This will open the Web-based user interface. The Switch management features available in the web-based manager are explained below.

Web-based User Interface

The user interface provides access to various Switch configuration and management windows, it allows the user to view performance statistics, and permits graphical monitoring of the system status.

Areas of the User Interface

The figure below shows the user interface. Three distinct areas divide the user interface, as described in the table.

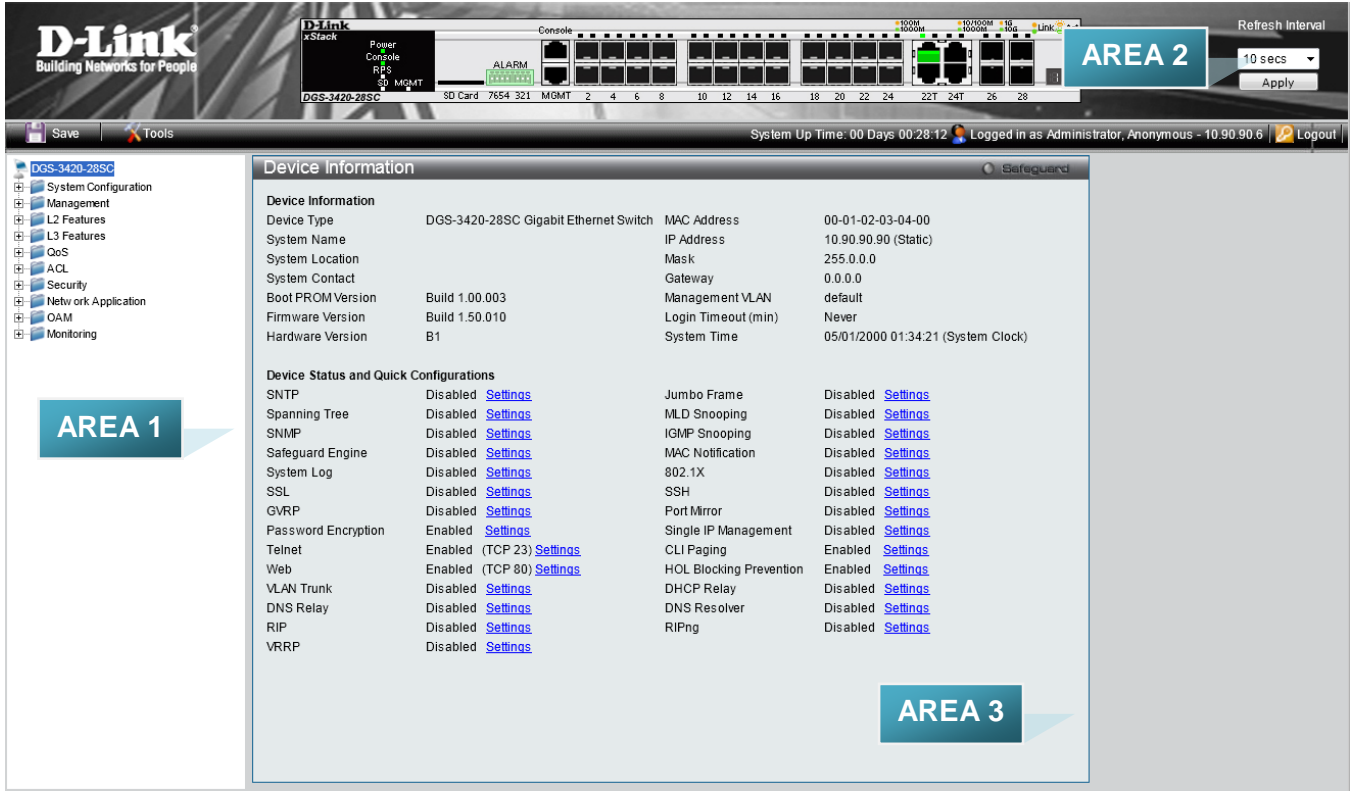

Figure 5–2 Main Web-manager Window

Area	Function
Area 1	Select the folder or window to display. Open folders and click the hyperlinked window buttons and subfolders contained within them to display windows.
Area 2	Presents a graphical near real-time image of the front panel of the Switch. This area displays the Switch's ports and expansion modules and shows port activity, depending on the specified mode. Some management functions, including port monitoring are accessible here. Click the D-Link logo to go to the D-Link Website.
Area 3	Presents Switch status based on user selection and the entry of configuration data. In addition, hyperlinks are offered for many Switch features to enable quick configuration.

Web Pages

When connecting to the management mode of the Switch with a Web browser, a login screen is displayed. Enter a user name and password to access the Switch's management mode.

Below is a list of the main folders available in the Web interface:

- **System Configuration** - In this section the user will be able to configure features regarding the Switch's configuration.
- **Management** - In this section the user will be able to configure features regarding the Switch's management.
- **L2 Features** - In this section the user will be able to configure features regarding the Layer 2 functionality of the Switch.
- **L3 Features** - In this section the user will be able to configure features regarding the Layer 3 functionality of the Switch.
- **QoS** - In this section the user will be able to configure features regarding the Quality of Service functionality of the Switch.
- **ACL** - In this section the user will be able to configure features regarding the Access Control List functionality of the Switch.
- **Security** - In this section the user will be able to configure features regarding the Switch's security.
- **Network Application** - In this section the user will be able to configure features regarding network applications handled by the Switch.
- **OAM** - In this section the user will be able to configure features regarding the Switch's operations, administration and maintenance (OAM).
- **Monitoring** - In this section the user will be able to monitor the Switch's configuration and statistics.

Appendix Section

Appendix A – Technical Specifications

General

Feature	Detailed Description										
Standards	IEEE 802.3 compliance IEEE 802.3u compliance Support Full-Duplex operations IEEE 802.3az compliance (Hardware Version :B1) IEEE 802.3x Flow Control support for Full-Duplex mode IEEE 802.3ab compliance IEEE 802.3af compliance (DGS-3420-28PC & DGS-3420-52P only) IEEE 802.3at compliance (DGS-3420-28PC & DGS-3420-52P only) IEEE 802.3z compliance IEEE 802.3ae compliance IEEE 802.3aq compliance IEEE 1588										
Protocols	CSMA/CD										
Data Transfer Rates: Ethernet Fast Ethernet Gigabit Ethernet 10 Gigabit Ethernet	<table> <tr> <td>Half-duplex</td> <td>Full-duplex</td> </tr> <tr> <td>10 Mbps</td> <td>20Mbps</td> </tr> <tr> <td>100Mbps</td> <td>200Mbps</td> </tr> <tr> <td>-----</td> <td>2Gbps</td> </tr> <tr> <td>-----</td> <td>20Gbps</td> </tr> </table>	Half-duplex	Full-duplex	10 Mbps	20Mbps	100Mbps	200Mbps	-----	2Gbps	-----	20Gbps
Half-duplex	Full-duplex										
10 Mbps	20Mbps										
100Mbps	200Mbps										
-----	2Gbps										
-----	20Gbps										
Stacking Topology	Duplex Ring, Duplex Chain										
Network Cables	Cat.5 Enhanced for 1000BASE-T UTP Cat.5, Cat. 5 Enhanced for 100BASE-TX UTP Cat.3, 4, 5 for 10BASE-T EIA/TIA-568 100-ohm screened twisted-pair (STP)(100m)										

Physical and Environmental

Feature	Detailed Description
Internal Power Supply	AC Input: 100~240VAC, 50~60Hz
Optional Redundant Power Supply	One connector in back to install optional external RPS. When internal power fails, the optional external RPS will take over all the power supply immediately and automatically. DPS-500: DGS-3420-28SC/28TC/26SC/52T DPS-700: DGS-3420-28PC/52P
Fans	The IC Sensor detects the temperature on the switch automatically, and adjusts the speed.
Power Consumption	For hardware version A1/A2, the following applies: DGS-3420-28SC: 60.3 Watts (Max.) DGS-3420-28TC: 50.8 Watts (Max.)

	<p>DGS-3420-26SC: 60.3 Watts (Max.) DGS-3420-28PC: 478 Watts (Max.) with 350 Watts PoE load. DGS-3420-52T: 81.0 Watts (Max.) DGS-3420-52P: 505.4 Watts (Max.) with 350 Watts PoE load</p> <p>For hardware version B1, the following applies: DGS-3420-28SC: 42.6 Watts (Max.) DGS-3420-28TC: 44.9 Watts (Max.) DGS-3420-26SC: 40.2 Watts (Max.) DGS-3420-28PC: 502.2 Watts (Max.) with 370 Watts PoE load DGS-3420-52T: 76 Watts (Max.) DGS-3420-52P: 517.1 Watts (Max.) with 370 Watts PoE load</p>
Operating Temperature	0~50°C
Storage Temperature	-40~70°C
Humidity	Storage: 5-90% non-condensing Operation: 10-90% non-condensing
Dimensions	<p>DGS-3420-28SC: 441mm (W) x 310mm (D) x 44mm (H) DGS-3420-28TC: 441mm (W) x 310mm (D) x 44mm (H) DGS-3420-26SC: 441mm (W) x 310mm (D) x 44mm (H) DGS-3420-28PC: 441mm (W) x 380mm (D) x 44mm (H) DGS-3420-52T: 441mm (W) x 380mm (D) x 44mm (H) DGS-3420-52P: 441mm (W) x 380mm (D) x 44mm (H)</p>
Weight	<p>DGS-3420-28SC: 4.06kg DGS-3420-28TC: 4.12kg DGS-3420-26SC: 4.04kg DGS-3420-28PC: 5.75kg DGS-3420-52T: 5.07kg DGS-3420-52P: 6.24kg</p>
EMI	CE Class A, FCC Class A, VCCI Class A, C-Tick Report
Safety	UL, CB Report

Performance

Feature	Detailed Description
Transmission Method	Store-and-forward
Packet Buffer	2Mbytes per device
Packet Filtering / Forwarding Rate	Full-wire speed for all connections 1,488,095 pps per port (for 1000Mbps) 148,810 pps per port (100Mbps)
Wire speed	Wire speed operation on all FE/GE ports
Switching Capacity	<p>DGS-3420-28SC: 128Gbps DGS-3420-28TC: 128Gbps DGS-3420-26SC: 88Gbps DGS-3420-28PC: 128Gbps</p>

	DGS-3420-52T: 176Gbps DGS-3420-52P: 176Gbps
Maximum Forwarding Rate	DGS-3420-28SC: 95.24 million packets per second. DGS-3420-28TC: 95.24 million packets per second. DGS-3420-26SC: 66.47 million packets per second. DGS-3420-28PC: 95.24 million packets per second. DGS-3420-52T: 130.95 million packets per second. DGS-3420-52P: 130.95 million packets per second.
Priority Queues	8 Priority Queues per port
MAC Address Table	Supports 16K MAC address Supports 256 static MAC
Virtual Stacking / Clustering	<ul style="list-style-type: none"> Support D-Link Single IP Management v1.6 Manage up to 32 devices in a virtual stack with a single IP address.

LED Indicators

Location	LED Indicative	Color	Status	Description
Per Device	Power	Green	Solid Light	Power on
			Light off	Power off
	Console	Green	Solid Light	Console on
			Light off	Console off
	RPS	Green	Blinking	When switch detects that RPS is connected
			Solid Light	RPS in using
			Light off	RPS off
	SD	Green	Solid Light	Plugged in
			Blinking	Busy Reading and Writing
			Light off	No link
		Red	Solid Light	Read/Write Failed
	MGMT	Green	Solid Light	Console on
			Blinking	Secure connection established
			Light off	Console off
	Stacking ID	Green	Capable 1 – 12, H, h, G	<p>The box ID is assigned either by user (static mode) or by the system (automatic mode). When the box become a primary master, the 7 segment works as bi-function. That is box ID and “H” indicate as primary Master and the display will be shown by turn. That is boxID -> H -> boxID -> H</p> <p>1-12: To indicate the stacking of the switch</p> <p>H: When device was assigned as the stacking Master</p>

				h: When device was selected to be the Backup Master G: When Safeguard Engine entering the exhausted mode.
	Port LED Mode Indicator	A LED Mode Select Button to switch two modes in turn for all 10/100/1000Mbps ports on DGS-3420-28PC/52P: - Link/Act/Speed Mode - PoE Mode		
		Green	Solid Light	A LED Mode Select Button to switch Link/Act/Speed Mode
			Solid Light	A LED Mode Select Button to switch PoE Mode
LED Per 10/100/1000 Mbps Port	Link/Act/Speed Mode	Green	Solid Light	When there is a secure connection (or link) to 1000Mbps Ethernet device at any of the ports.
			Blinking	When there is reception or transmission of data occurring at 1000Mbps.
		Orange	Solid Light	When there is a secure connection (or link) to 10/100Mbps Ethernet device at any of the ports.
			Blinking	When there is reception or transmission of data occurring at 10/100Mbps.
		Off	Light off	No link.
	PoE Mode	Green	Solid Light	Power feeding.
		Orange	Solid Light	Error Condition.
Off		Light Off	No Power feeding.	
LED per SFP Port	Link/Act	Green	Solid Light	When there is a secure connection (or link) to 1000Mbps Ethernet device at any of the ports.
			Blinking	When there is reception or transmission of data occurring at 1000Mbps.
		Orange	Solid Light	When there is a secure connection (or link) to 100Mbps Ethernet device at any of the ports.
			Blinking	When there is reception or transmission of data occurring at 100Mbps.
		Off	Light off	No link
LED per SFP+ Port	Link/Act	Green	Solid Light	When there is a secure connection (or link) to 10G bps Ethernet device at any of the ports.
			Blinking	When there is reception or transmission (i.e. Activity--Act) of data occurring at a 10G bps port.
		Orange	Solid Light	When there is a secure connection (or link) to 1000Mbps Ethernet device at

				any of the ports.
			Blinking	When there is reception or transmission (i.e. Activity--Act) of data occurring at a 1000Mbps port.
		Off	Light off	Link down

Port Functions

Feature	Detailed Description
Console Port	RJ-45 interface for out-of-band CLI configuration
1G Port	<p>10/100/1000BASE-T ports compliant to following standards:</p> <ul style="list-style-type: none"> • IEEE 802.3 compliance • IEEE 802.3u compliance <p>100/1000BASE-T ports compliant to following standards:</p> <ul style="list-style-type: none"> • IEEE 802.3az compliance (Hardware Version :B1) <p>Support Full-Duplex operations</p> <ul style="list-style-type: none"> • IEEE 802.3x Flow Control support for Full-Duplex mode • IEEE 802.3ab compliance • IEEE 802.3af compliance (DGS-3420-28PC & DGS-3420-52P only) • IEEE 802.3at compliance (DGS-3420-28PC & DGS-3420-52P only) <p>SFP ports compliant to following standards:</p> <ul style="list-style-type: none"> • IEEE 802.3z compliance <p>SFP Transceivers Supported:</p> <ul style="list-style-type: none"> • DEM-310GT (1000BASE-LX, Single-mode, 10km) • DEM-311GT (1000BASE-SX, Mutli-mode, 550m) • DEM-312GT2 (1000BASE-SX, Multi-mode, 2km) • DEM-314GT (1000BASE-LHX, Single-mode, 50km) • DEM-315GT (1000BASE-ZX, Single-mode, 80km) • DGS-712 (1000BASE-TX) • DEM-330T/R (1000BASE-BX, WDM transceiver, Single-Mode 10km) • DEM-331T/R (1000BASE-BX, WDM transceiver, Single-Mode 40km) • DEM-210 (100BASE-FX, Single-mode, 15km) • DEM-211 (100BASE-FX, Multi-mode, 2km) • DEM-220T (100BASE-BX, Wavelength Tx:1550nm, Rx:1310nm, Single-mode, 20km) • DEM-220R (100BASE-BX, Wavelength Tx:1310nm, Rx:1550nm, Single-mode, 20km)

PoE Specifications

- Supports IEEE 802.3af PoE and IEEE 802.3at PoE+ compliance.
- Supplies power to PD devices up to 15.4W per port (802.3af) or 30W+ per port (802.3at) more sufficiently.
- Power Budget: 370W.
- Supports the Auto Discovery feature. It'll automatically recognize a connection to PD devices and immediately provide power.
- Supports the Auto Disable Port feature. If the port's electrical current is over 600mA, this feature will activate and still keep the other ports active.
- Supports the Active Circuit Protection feature. It'll automatically disable a port if there is an electrical short and still keep the other ports active.

Power Classification Table:

Class	Usage	Max power used by PD
0	Default	12.95W
1	Optional	3.84W
2	Optional	6.49W
3	Optional	12.95W
4	Reserved	12.95W

- For 802.3at capable devices, provide power allocation of 0.1 watt granularity using LLDP method.

Class	Usage	Minimum power levels of output of PSE
0	Default	15.4W
1	Optional	4.0W
2	Optional	7.0W
3	Optional	15.4W
4	Reserved	31W

Class	Usage	Max power received by PD
0	Default	13.0W
1	Optional	3.84W
2	Optional	6.49W
3	Optional	13.0W
4	Reserved	25.5W

- Follow the PSE pin out standard of Alternative A, sending out power over pins 1, 2, 3, 6 and 8 of CAT3~6A UTP cables for 802.3af devices; or CAT5e~6A UTP cables for 802.3at devices.
- DGS-3420-28PC, DGS-3420-52P works with all D-Link 802.3af and 802.3at capable devices It also works with all non-802.3af and non-802.3at capable D-Link Access Points, IP Cameras and IP phones using the DWL-P50 PoE adapter.

10G Ports

SFP+ Transceivers Supported:

- DEM-431XT-DD (10GBASE-SR SFP+ Transceiver, 80m: OM1 & OM2 MMF 300m: OM3 MMF)
- DEM-431XT (10GBASE-SR SFP+ Transceiver (w/o DDM), 80m: OM1 & OM2 MMF 300m: OM3 MMF)
- DEM-432XT-DD (10GBASE-LR SFP+ Transceiver, 10km)
- DEM-432XT (10GBASE-LR SFP+ Transceiver (w/o DDM), 10km)
- DEM-433XT-DD (10GBASE-ER SFP+ Transceiver, 40km)
- DEM-433XT (10GBASE-ER SFP+ Transceiver (w/o DDM), 40km)
- DEM-435XT-DD (10GBASE-LRM SFP+ Transceiver, 220m: OM1 & OM2 MMF, 300m: OM3 MMF)
- DEM-435XT (10GBASE-LRM SFP+ Transceiver (w/o DDM), 220m: OM1 & OM2 MMF, 300m: OM3 MMF)
- DEM-436XT-BXU (10GBASE-LR BiDi SFP+ Transceiver (w/o DDM), 20km, TX: 1270nm, RX: 1330nm)
- DEM-436XT-BXD (10GBASE-LR BiDi SFP+ Transceiver (w/o DDM), 20km, TX: 1330nm, RX: 1270nm)
- DEM-310GT (1000BASE-LX, Single-mode, 10km)
- DEM-311GT (1000BASE-SX, Mutli-mode, 550m)
- DEM-312GT2 (1000BASE-SX, Multi-mode, 2km)
- DEM-314GT (1000BASE-LHX, Single-mode, 50km)
- DEM-315GT (1000BASE-ZX, Single-mode, 80km)
- DEM-330T/R (1000BASE-BX, WDM transceiver, Single-Mode 10km)
- DEM-331T/R (1000BASE-BX, WDM transceiver, Single-Mode 40km)
- DEM-CB100S-10-GbE SFP+1m Direct Attach Cable
- DEM-CB300S-10-GbE SFP+3m Direct Attach Cable
- DEM-CB700S-10-GbE SFP+7m Direct Attach Cable

Appendix B – Cables and Connectors

Ethernet Cable

When connecting the Switch to another switch, a bridge or hub, a normal cable is necessary. Please review these products for matching cable pin assignment. The following diagrams and tables show the standard RJ-45 connector and their pin assignments.

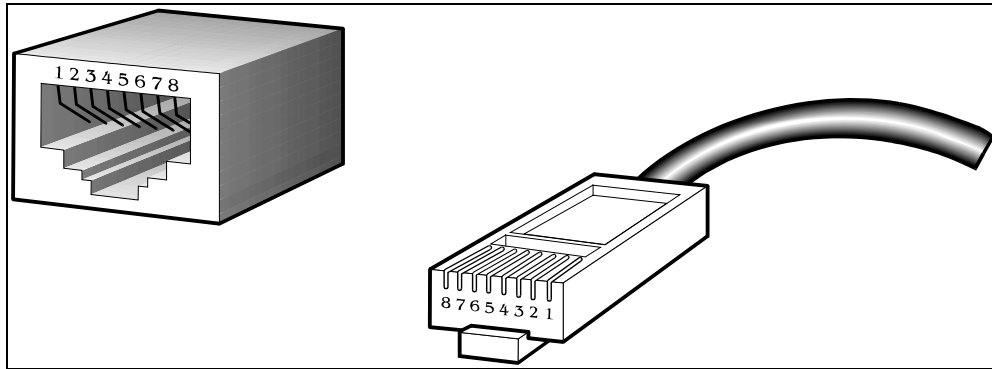

Figure 5–3 Standard RJ-45 port and connector

RJ-45 Pin Assignments		
Pin	MDI-X Port	MDI-II Port
1	RD+ (receive)	TD+ (transmit)
2	RD- (receive)	TD- (transmit)
3	TD+ (transmit)	RD+ (receive)
4	1000BASE-T	1000BASE-T
5	1000BASE-T	1000BASE-T
6	TD- (transmit)	RD- (receive)
7	1000BASE-T	1000BASE-T
8	1000BASE-T	1000BASE-T

Console Cable

When connecting the Switch to a PC, a Console cable is necessary. The following diagrams and tables show the standard Console-to-DJ-45 receptacle/connector and their pin assignments.

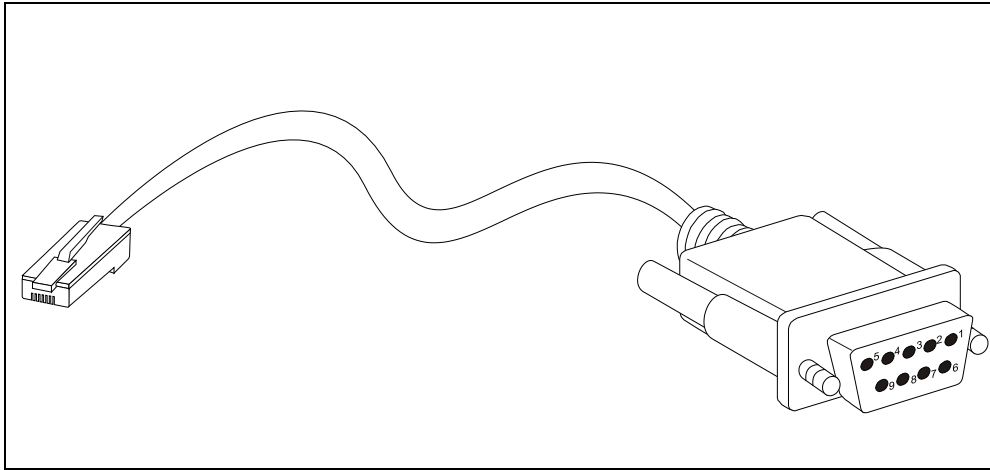

Figure 5-4 Console-to-RJ-45 Cable

Console-RJ-45 Pin Assignments		
Pin	Console (DB9/RS232)	RJ-45
1	Not Used	Not Used
2	RXD	Not Used
3	TXD	TXD
4	Not Used	GND
5	GND (shared)	GND
6	Not Used	RXD
7	Not Used	Not Used
8	Not Used	Not Used

Redundant Power Supply (RPS) Cable

When connecting the Switch to a Redundant Power Supply, an RPS cable is necessary. Please review these products for matching cable pins. The following diagrams and tables show the standard RPS connector and their pin assignments.



NOTE: The DGS-3420-28PC and the DGS-3420-52P use the RPS-700 and not the RPS-500. Both devices have their own cables included in the package.

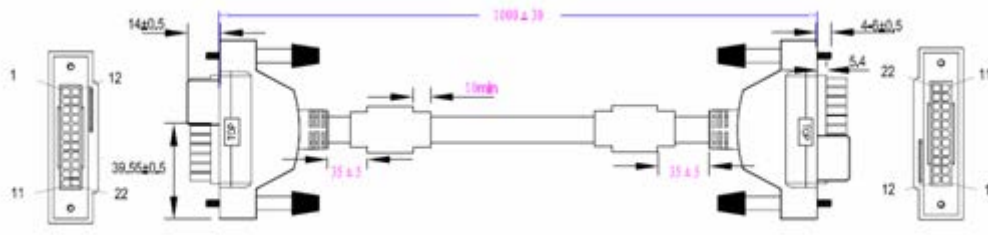

Figure 5–5 Redundant Power Supply (RPS) Cable – DPS-500/DPS-700

RPS Cable Pin Assignments		
Pin	Device	DPS-500
1	NC	NC
2	GND	GND
3	GND	GND
4	GND	GND
5	GND	GND
6	+12V	+12V
7	+12V	+12V
8	+12V	RS+ (12V)
9	NC	Power Present
10	NC	Power Good
11	RPS Present	RPS Present
12	RPS Power Good	RPS Power Good
13	NC	+5V
14	+12V	+12V

RPS Cable Pin Assignments		
Pin	Device	DPS-700
1	-54Vrtn	-54Vrtn
2	-54V	-54V
3	+12V	+12V
4	+12V	+12V
5	+12V	+12V
6	+12V	+12V

7	GND	GND
8	+12VRTNsen	+12Vsen
9	LS-54V	LS-54V
10	-54V	-54V
11	-54Vrtn	-54Vrtn
12	GND	NC/GND
13	NC	GND
14	RPS Present	RPS Present
15	Status-1	Status-1
16	Status-2	Status-2
17	RPS Power Good	RPS Power Good
18	GND	GND
19	+12VRTNsen	+12VRTNsen
20	LS+12V	LS+12V
21	-54Vsen	-54Vsen
22	-54VRTNsen	-54VRTNsen

Appendix C – Module Specs and Cable Lengths

Use the following table to as a guide for the module specs and maximum cable lengths.

Standard	Media Type	Maximum Distance
Mini-GBIC	1000BASE-LX, Single-mode fiber module	10km
	1000BASE-SX, Multi-mode fiber module	550m / 2km
	1000BASE-LH, Single-mode fiber module	50km
	1000BASE-ZX, Single-mode fiber module	80km
1000BASE-T	Category 5e UTP Cable	100m
100BASE-TX	Category 5 UTP Cable (100 Mbps)	100m
10BASE-T	Category 3, 4 or 5 UTP Cable (10 Mbps)	100m
DEM-310GT	1000BASE-LX, Single-mode	10km
DEM-311GT	1000BASE-SX, Multi-mode	550m
DEM-312GT2	1000BASE-SX, Multi-mode	2km
DEM-314GT	1000BASE-LHX, Single-mode	50km
DEM-315GT	1000BASE-ZX, Single-mode	80km
DEM-210	100BASE-FX, Single-mode	15km
DEM-211	100BASE-FX, Multi-mode	2km
DEM-220T	100BASE-BX, Single-mode	Up to 20km
DEM-220R	100BASE-BX, Single-mode	Up to 20km
DEM-330T	TX-1550/RX-1310nm, Single-mode	Up to 10km
DEM-330R	TX-1310/RX-1550nm, Single-mode	Up to 10km
DEM-331T	TX-1550/RX-1310nm, Single-Mode	Up to 40km
DEM-331R	TX-1310/RX-1550nm, Single-Mode	Up to 40km
DGS-712	1G Copper, 1000BASE-T	100m

Network pluggable optical modules meet the following regulatory requirements:

- Class 1 Laser Product
- EN60825-1+A2:2001 or later, European laser standard
- FCC 21 CFR Chapter 1, Subchapter J in accordance with FDA & CDRH requirements

Warranties

Technical Support

Free Manuals Download Website

<http://myh66.com>

<http://usermanuals.us>

<http://www.somanuals.com>

<http://www.4manuals.cc>

<http://www.manual-lib.com>

<http://www.404manual.com>

<http://www.luxmanual.com>

<http://aubethermostatmanual.com>

Golf course search by state

<http://golfingnear.com>

Email search by domain

<http://emailbydomain.com>

Auto manuals search

<http://auto.somanuals.com>

TV manuals search

<http://tv.somanuals.com>