



**X S T A C K**<sup>®</sup>

## Hardware Installation Guide

Product Model: **xStack**<sup>®</sup> DGS-3620 Series  
Layer 3 Managed Stackable Gigabit Switch  
Release 2.60



Information in this document is subject to change without notice.

Reproduction in any manner whatsoever, without the written permission of D-Link Corporation, is strictly forbidden.

Trademarks used in this text: D-Link and the D-LINK logo are trademarks of D-Link Corporation; Microsoft and Windows are registered trademarks of Microsoft Corporation.

Other trademarks and trade names may be used in this document to refer to either the entities claiming the marks and names or their products. D-Link Corporation disclaims any proprietary interest in trademarks and trade names other than its own.

© 2013 D-Link Corporation. All rights reserved.

October, 2013 P/N 651GS3620045G

### **FCC Warning**

This equipment has been tested and found to comply with the limits for a Class A digital device, pursuant to Part 15 of the FCC Rules. These limits are designed to provide reasonable protection against harmful interference when the equipment is operated in a commercial environment. This equipment generates, uses, and can radiate radio frequency energy and, if not installed and used in accordance with this manual, may cause harmful interference to radio communications. Operation of this equipment in a residential area is likely to cause harmful interference in which case the user will be required to correct the interference at his expense.

### **CE Mark Warning**

This is a Class A product. In a domestic environment, this product may cause radio interference in which case the user may be required to take adequate measures.

### **Warnung!**

Dies ist ein Produkt der Klasse A. Im Wohnbereich kann dieses Produkt Funkstörungen verursachen. In diesem Fall kann vom Benutzer verlangt werden, angemessene Massnahmen zu ergreifen.

### **Precaución!**

Este es un producto de Clase A. En un entorno doméstico, puede causar interferencias de radio, en cuyo caso, puede requerirse al usuario para que adopte las medidas adecuadas.

### **Attention!**

Ceci est un produit de classe A. Dans un environnement domestique, ce produit pourrait causer des interférences radio, auquel cas l'utilisateur devrait prendre les mesures adéquates.

### **Attenzione!**

Il presente prodotto appartiene alla classe A. Se utilizzato in ambiente domestico il prodotto può causare interferenze radio, nel cui caso è possibile che l'utente debba assumere provvedimenti adeguati.

### **VCCI Warning**

この装置は、クラス A 情報技術装置です。この装置を家庭環境で使用すると電波妨害を引き起こすことがあります。この場合には使用者が適切な対策を講ずるよう要求されることがあります。 VCCI-A

### **BSMI Notice**

此為甲類的資訊技術設備，在居住環境中使用時，可能會造成射頻擾動，在這種情況下，使用者會被要求採取某些適當的對策。

# Table of Contents

|  |           |
|--|-----------|
| Intended Readers .....                                   | v         |
| Typographical Conventions .....                          | v         |
| Notes, Notices, and Cautions .....                       | v         |
| Safety Instructions .....                                | vi        |
| Safety Precautions .....                                 | vi        |
| General Precautions for Rack-Mountable Products .....    | vii       |
| Protecting Against Electrostatic Discharge .....         | viii      |
| <b>Chapter 1 Introduction.....</b>                       | <b>9</b>  |
| Switch Description .....                                 | 9         |
| Features.....  | 10        |
| Ports .....  | 11        |
| Front-Panel Components .....                             | 12        |
| LED Indicators .....                                     | 13        |
| Rear Panel Description.....                              | 14        |
| Side Panel Description .....                             | 15        |
| <b>Chapter 2 Installation.....</b>                       | <b>18</b> |
| Package Contents .....                                   | 18        |
| Installation Guidelines .....                            | 18        |
| Installing the Switch without a Rack .....               | 19        |
| Attaching Brackets to a Switch for Rack Mounting .....   | 19        |
| Mounting the Switch in a Standard 19" Rack .....         | 20        |
| Power On (AC Power).....                                 | 20        |
| Power Failure (AC Power) .....                           | 20        |
| Alarm Connector.....                                     | 20        |
| Installing SFP and SFP+ Ports.....                       | 22        |
| Connecting to a Redundant Power Supply .....             | 23        |
| External Redundant Power System .....                    | 24        |
| DPS-900.....   | 24        |
| DPS-800.....   | 25        |
| <b>Chapter 3 Connecting the Switch.....</b>              | <b>27</b> |
| Switch to End Node .....                                 | 27        |
| Switch to Switch .....                                   | 27        |
| Connect to a Network Backbone or Server .....            | 28        |
| <b>Chapter 4 Introduction to Switch Management .....</b> | <b>29</b> |
| Management Options .....                                 | 29        |
| Connecting the Console Port.....                         | 29        |
| Connecting to the Switch for the First Time .....        | 31        |
| Connecting to the Management Port.....                   | 31        |
| Password Protection.....                                 | 32        |
| Assigning IP Addresses.....                              | 32        |
| SNMP Settings .....                                      | 34        |
| Traps.....   | 34        |
| Management Information Base (MIB).....                   | 35        |
| <b>Chapter 5 Web-based Switch Configuration .....</b>    | <b>36</b> |
| Introduction .....                                       | 36        |
| Logging onto the Web Manager .....                       | 36        |
| Web-based User Interface.....                            | 37        |
| Areas of the User Interface.....                         | 37        |
| Web Pages.....   | 38        |

|  |           |
|--|-----------|
| <b>Appendix A – Technical Specifications .....</b> | <b>39</b> |
| General .....                                      | 39        |
| Physical and Environmental .....                   | 39        |
| Performance .....                                  | 40        |
| LED Indicators .....                               | 41        |
| Port Functions.....                                | 43        |
| <b>Appendix B – Cables and Connectors .....</b>    | <b>46</b> |
| Ethernet Cable.....                                | 46        |
| Console Cable .....                                | 47        |
| Redundant Power Supply (RPS) Cable .....           | 48        |
| <b>Warranties &amp; Technical Support.....</b>     | <b>50</b> |

# Intended Readers

- Intended Readers**
- Typographical Conventions**
- Notes, Notices, and Cautions**
- Safety Instructions**
- General Precautions for Rack-Mountable Products**
- Protecting Against Electrostatic Discharge**

The **DGS-3620 Series Hardware Installation Guide** contains information for set up and management of the Switch. This manual is intended for network managers familiar with network management concepts and terminology. For all practical reasons all the switches in this series will be simply referred to as the Switch throughout this manual. All example screenshots are taken from the **DGS-3620-28SC** Switch. In some examples, where we refer to the Power over Ethernet examples, we'll use the **DGS-3620-28PC** Switch.

# Typographical Conventions

| Convention                        | Description   |
|-----------------------------------|---|
| [ ]                               | In a command line, square brackets indicate an optional entry. For example: [copy filename] means that optionally you can type copy followed by the name of the file. Do not type the brackets.   |
| <b>Bold font</b>                  | Indicates a button, a toolbar icon, menu, or menu item. For example: Open the <b>File</b> menu and choose <b>Cancel</b> . Used for emphasis. May also indicate system messages or prompts appearing on screen. For example: <b>You have mail</b> .        |
| Boldface Typewriter Font          | Indicates commands and responses to prompts that must be typed exactly as printed in the manual.  |
| Initial capital letter            | Indicates a window name. Names of keys on the keyboard have initial capitals. For example: Click <b>Enter</b> .   |
| <i>Italics</i>                    | Indicates a window name or a field. Also can indicate a variables or parameter that is replaced with an appropriate word or string. For example: type <i>filename</i> means that the actual filename should be typed instead of the word shown in italic. |
| <b>Menu Name &gt; Menu Option</b> | <b>Menu Name &gt; Menu Option</b> indicates the menu structure. <b>Device &gt; Port &gt; Port Properties</b> means the Port Properties menu option under the Port menu option that is located under the Device menu.                                      |

# Notes, Notices, and Cautions



A **NOTE** indicates important information that helps make better use of the device.



A **NOTICE** indicates either potential damage to hardware or loss of data and shows you how to avoid the problem.



A **CAUTION** indicates a potential for property damage, personal injury, or death.

# Safety Instructions

Use the following safety guidelines to ensure your own personal safety and to help protect your system from potential damage. Throughout this safety section, the caution icon () is used to indicate precautions that need to be reviewed and followed.

## Safety Precautions

To reduce the risk of bodily injury, electrical shock, fire, and damage to the equipment observe the following precautions:

- Observe and follow service markings.
- Do not service any product except as explained in the system documentation.
- Opening or removing covers that are marked with the triangular symbol with a lightning bolt may expose the user to electrical shock.
  - Only a trained service technician should service components inside these compartments.
- If any of the following conditions occur, unplug the product from the electrical outlet and replace the part or contact your trained service provider:
  - Damage to the power cable, extension cable, or plug.
  - An object has fallen into the product.
  - The product has been exposed to water.
  - The product has been dropped or damaged.
  - The product does not operate correctly when the operating instructions are correctly followed.
- Keep your system away from radiators and heat sources. Also, do not block cooling vents.
- Do not spill food or liquids on system components, and never operate the product in a wet environment. If the system gets wet, contact your trained service provider.
- Do not push any objects into the openings of the system. Doing so can cause fire or electric shock by shorting out interior components.
- Use the product only with approved equipment.
- Allow the product to cool before removing covers or touching internal components.
- Operate the product only from the type of external power source indicated on the electrical ratings label. If unsure of the type of power source required, consult your service provider or local power company.
- To help avoid damaging the system, be sure the voltage selection switch (if provided) on the power supply is set to match the power available at the Switch's location:
  - 115 volts (V)/60 hertz (Hz) in most of North and South America and some Far Eastern countries such as South Korea and Taiwan
  - 100 V/50 Hz in eastern Japan and 100 V/60 Hz in western Japan
  - 230 V/50 Hz in most of Europe, the Middle East, and the Far East
- Also, be sure that attached devices are electrically rated to operate with the power available in your location.
- Use only approved power cable(s). If you have not been provided with a power cable for your system or for any AC-powered option intended for your system, purchase a power cable that is approved for use in your country. The power cable must be rated for the product and for the voltage and current marked on the product's electrical ratings label. The voltage and current rating of the cable should be greater than the ratings marked on the product.
- To help prevent electric shock, plug the system and peripheral power cables into properly grounded electrical outlets. These cables are equipped with three-prong plugs to help ensure proper grounding. Do not use adapter plugs or remove the grounding prong from a cable. If using an extension cable is necessary, use a 3-wire cable with properly grounded plugs.
- Observe extension cable and power strip ratings. Make sure that the total ampere rating of all products plugged into the extension cable or power strip does not exceed 80 percent of the ampere ratings limit for the extension cable or power strip.
- To help protect the system from sudden, transient increases and decreases in electrical power, use a surge suppressor, line conditioner, or uninterruptible power supply (UPS).

- Position system cables and power cables carefully; route cables so that they cannot be stepped on or tripped over. Be sure that nothing rests on any cables.
- Do not modify power cables or plugs. Consult a licensed electrician or your power company for site modifications. Always follow your local/national wiring rules.
- When connecting or disconnecting power to hot-pluggable power supplies, if offered with your system, observe the following guidelines:
  - Install the power supply before connecting the power cable to the power supply.
  - Unplug the power cable before removing the power supply.
  - If the system has multiple sources of power, disconnect power from the system by unplugging all power cables from the power supplies.
- Move products with care; ensure that all casters and/or stabilizers are firmly connected to the system. Avoid sudden stops and uneven surfaces.

## General Precautions for Rack-Mountable Products

Observe the following precautions for rack stability and safety. Also, refer to the rack installation documentation accompanying the system and the rack for specific caution statements and procedures.

- Systems are considered to be components in a rack. Thus, "component" refers to any system as well as to various peripherals or supporting hardware.



**CAUTION:** Installing systems in a rack without the front and side stabilizers installed could cause the rack to tip over, potentially resulting in bodily injury under certain circumstances. Therefore, always install the stabilizers before installing components in the rack. After installing system/components in a rack, never pull more than one component out of the rack on its slide assemblies at one time. The weight of more than one extended component could cause the rack to tip over and may result in serious injury.

- Before working on the rack, make sure that the stabilizers are secured to the rack, extended to the floor, and that the full weight of the rack rests on the floor. Install front and side stabilizers on a single rack or front stabilizers for joined multiple racks before working on the rack.
- Always load the rack from the bottom up, and load the heaviest item in the rack first.
- Make sure that the rack is level and stable before extending a component from the rack.
- Use caution when pressing the component rail release latches and sliding a component into or out of a rack; the slide rails can pinch your fingers.
- After a component is inserted into the rack, carefully extend the rail into a locking position, and then slide the component into the rack.
- Do not overload the AC supply branch circuit that provides power to the rack. The total rack load should not exceed 80 percent of the branch circuit rating.
- Ensure that proper airflow is provided to components in the rack.
- Do not step on or stand on any component when servicing other components in a rack.



**NOTE:** A qualified electrician must perform all connections to DC power and to safety grounds. All electrical wiring must comply with applicable local or national codes and practices.



**CAUTION:** Never defeat the ground conductor or operate the equipment in the absence of a suitably installed ground conductor. Contact the appropriate electrical inspection authority or an electrician if uncertain that suitable grounding is available.



**CAUTION:** The system chassis must be positively grounded to the rack cabinet frame. Do not attempt to connect power to the system until grounding cables are connected. Completed power and safety ground wiring must be inspected by a qualified electrical inspector. An energy hazard will exist if the safety ground cable is omitted or disconnected.

## Protecting Against Electrostatic Discharge

Static electricity can harm delicate components inside the system. To prevent static damage, discharge static electricity from your body before touching any of the electronic components, such as the microprocessor. This can be done by periodically touching an unpainted metal surface on the chassis.

The following steps can also be taken prevent damage from electrostatic discharge (ESD):

1. When unpacking a static-sensitive component from its shipping carton, do not remove the component from the antistatic packing material until ready to install the component in the system. Just before unwrapping the antistatic packaging, be sure to discharge static electricity from your body.
2. When transporting a sensitive component, first place it in an antistatic container or packaging.
3. Handle all sensitive components in a static-safe area. If possible, use antistatic floor pads, workbench pads and an antistatic grounding strap.



# Chapter 1 Introduction

## **Switch Description**

### **Features**

### **Ports**

### **Front-Panel Components**

### **Rear Panel Description**

### **Side Panel Description**

## Switch Description

The D-Link DGS-3620 Series is a high performance member of the D-Link xStack® family. Ranging from 10/100/1000 Mbps edge switches to core gigabit switches, the xStack® switch family has been future-proof designed to provide fault tolerance, flexibility, port density, robust security and maximum throughput with a user-friendly management interface for the networking professional.

The Series features the following list of switches:

- **DGS-3620-28TC:** Twenty Copper ports (10/100/1000Mbps), Four Combo Copper/SFP ports (10/100/1000Mbps and 100/1000Mbps), Four SFP+ ports (10GE), Layer 3 Stackable Managed Switch.
- **DGS-3620-28TC-DC:** Twenty Copper ports (10/100/1000Mbps), Four Combo Copper/SFP ports (10/100/1000Mbps and 100/1000Mbps), Four SFP+ ports (10GE), Layer 3 Stackable Managed Switch with DC Power.
- **DGS-3620-28SC:** Twenty SFP ports (100/1000Mbps), Four Combo Copper/SFP ports (10/100/1000Mbps and 100/1000Mbps), Four SFP+ ports (10GE), Layer 3 Stackable Managed Switch.
- **DGS-3620-28SC-DC:** Twenty SFP ports (100/1000Mbps), Four Combo Copper/SFP ports (10/100/1000Mbps and 100/1000Mbps), Four SFP+ ports (10GE), Layer 3 Stackable Managed Switch with DC Power.
- **DGS-3620-28PC:** Twenty Copper PoE ports (10/100/1000Mbps), Four Combo Copper PoE/SFP ports (10/100/1000Mbps and 100/1000Mbps), Four SFP+ ports (10GE), Layer 3 Stackable Managed Switch.
- **DGS-3620-52T:** Fourty-eight Copper ports (10/100/1000Mbps), Four SFP+ ports (10GE), Layer 3 Stackable Managed Switch.
- **DGS-3620-52P:** Fourty-eight Copper PoE ports (10/100/1000Mbps), Four SFP+ ports (10GE), Layer 3 Stackable Managed Switch.

This cost effective Gigabit Switch provides an affordable solution for administrators to upgrade their networks to high speed Gigabit connections. The dedicated stacking ports offer up to 40G or 80G bi-directional bandwidth, which makes the DGS-3620 Series also suitable as a backbone solution for SMBs. The advanced ACL and user authentication functions on the Switch extend the network security coverage from core to the edge. A unique D-Link Safeguard Engine protects the DGS-3620 Series from the threat of worms and viruses, thereby increasing overall reliability, serviceability, and availability

The Switch has a combination of 1000BASE-T ports and SFP ports that may be used in uplinking various network devices to the Switch, including PCs, hubs and other switches to provide a gigabit Ethernet uplink in full-duplex mode. The SFP (Small Form Factor Portable) combo ports are used with fiber-optical transceiver cabling in order to uplink various other networking devices for a gigabit link that may span great distances.

# Features

The list of features below highlights the significant features of the Switch in the **Standard Image (SI)** mode.

- Supports **Stacking** features, like Virtual Stacking and Physical Stacking.
- Supports **Layer 2** features, like Multicast Filtering, IGMP/MLD Snooping, IGMP/MLD Proxy, IGMP/MLD Filtering, Spanning Tree, Loopback Detection, Link Aggregation, Port Mirroring, and Layer 2 Protocol Tunneling.
- Supports **VLAN** features, like 802.1Q, VLAN Groups, Port-based VLAN, GVRP, MAC-based VLAN, VLAN Trunking, Asymmetric VLAN, ISM VLAN, Private VLAN, Subnet-based VLAN, Super VLAN, Voice VLAN, Q-in-Q, and Ethernet Ring Protection Switching.
- Supports **Layer 3** features, like Multiple IP Interfaces per VLAN, VRRP, ARP, Gratuitous ARP, Loopback Interface, and NULL Interface.
- Supports **Layer 3 Routing** features, like Static Routing, RIP, OSPF, Policy Based Routing, IP Directed Broadcast, Multi Path Routing, and Bidirectional Forwarding Detection.
- Supports **Layer 3 Multicasting** features, like IGMP (versions 1, 2, and 3), MLD, PIM-DM, PIM-SM, PIM-SSM, PIM Sparse-Dense Mode, and PIM Interface Passive Mode.
- Supports **OAM** features, like Cable Diagnostics.
- Supports **Quality of Service (QoS)** features, like 802.1p, Queue Handling, Weighted Random Early Detection (WRED), Class of Service (CoS), and Bandwidth Control.
- Supports **Access Control List (ACL)** features, like Basic ACL Policy, Time-based ACL, ACL Statistics, and CPU Interface Filtering.
- Supports **Security** features, like SSH, SSL, Port Security, Broadcast/Multicast/Unicast Storm Control, Traffic Segmentation, D-Link Safeguard Engine, BPDU Attack Protection, ARP Spoofing Prevention, IP-MAC-Port Binding, DHCP Server Screening, Secure FTP, and DoS Prevention.
- Supports **AAA** features, like 802.1X, Web-based Access Control, MAC-based Access Control, JWAC, Microsoft NAP Support, Guest VLAN, RADIUS, TACACS+, ZoneDefense, RADIUS Accounting, and Compound Authentication.
- Supports **Management** features, like Single IP Management, LLDP, LLDP-MED, Web-based GUI, CLI, Zmodem, TELNET Server/Client, TFTP Client, SNMP (versions 1, 2c, and 3), SNMP Traps, System Log, RMON, sFlow, BootP/DHCP Client, DHCP Auto-configuration, DHCP Server, DHCP Relay, DHCPv6 PD, UDP Helper, DNSv6, Trap/Alarm/Log Severity Control, Multiple Configuration, Flash File System (FFS), CPU Monitoring, Password Recovery, Password Encryption, SNTP, PTP, Network Load Balancing (NLB), and Optical Transceiver Digital Diagnostic Monitoring (DDM).
- Supports **Green** features, like Time-based PoE, and Power Saving.
- Supports **MIBs** like MIBII, Bridge MIB, SNMPv2 MIB, RMON MIB, RMONv2 MIB, Ether-like MIB, 802.3 MAU MIB, 802.1p MIB, IF MIB, RADIUS Authentication Client MIB, RIPv2 MIB, IP Forwarding Table MIB (CIDR), RADIUS Accounting Client MIB, Ping MIB, Traceroute MIB, L2 Specific MIB, L3 Specific MIB, Private MIB, Entity MIB, and ZoneDefense MIB.

The list of features below highlights the significant features of the Switch in the **Enhanced Image (EI)** mode.

- Supports all **Standard Image (SI)** features.
- Supports **Layer 3** features, like IPv6 Tunneling.
- Supports **Layer 3 Routing** features, like BGP, RIPng (IPv6), and OSPFv3.
- Supports **Layer 3 Multicasting** features like DVMRPv3, Static IP Multicast Route, and PIM-SM (IPv6).
- Supports **OAM** features, like 802.1ag Connectivity Fault Management (CFM), ITU-T Y.1731.

The D-Link Licence Management System (DLMS) enables users to upgrade this Switch from the SI mode to the EI mode by means of a License Key.

## Ports

The following table lists the ports that are present within each switch.

|                         |  |
|-------------------------|--|
| <b>DGS-3620-28TC</b>    | Twenty Copper ports (10/100/1000Mbps), Four Combo Copper/SFP ports (10/100/1000Mbps and 100/1000Mbps), Four SFP+ ports (10GE), Layer 3 Stackable Managed Switch.               |
| <b>DGS-3620-28TC-DC</b> | Twenty Copper ports (10/100/1000Mbps), Four Combo Copper/SFP ports (10/100/1000Mbps and 100/1000Mbps), Four SFP+ ports (10GE), Layer 3 Stackable Managed Switch with DC Power. |
| <b>DGS-3620-28SC</b>    | Twenty SFP ports (100/1000Mbps), Four Combo Copper/SFP ports (10/100/1000Mbps and 100/1000Mbps), Four SFP+ ports (10GE), Layer 3 Stackable Managed Switch.                     |
| <b>DGS-3620-28SC-DC</b> | Twenty SFP ports (100/1000Mbps), Four Combo Copper/SFP ports (10/100/1000Mbps and 100/1000Mbps), Four SFP+ ports (10GE), Layer 3 Stackable Managed Switch with DC Power.       |
| <b>DGS-3620-28PC</b>    | Twenty Copper PoE ports (10/100/1000Mbps), Four Combo Copper PoE/SFP ports (10/100/1000Mbps and 100/1000Mbps), Four SFP+ ports (10GE), Layer 3 Stackable Managed Switch.       |
| <b>DGS-3620-52T</b>     | Forty-eight Copper ports (10/100/1000Mbps), Four SFP+ ports (10GE), Layer 3 Stackable Managed Switch.  |
| <b>DGS-3620-52P</b>     | Forty-eight Copper PoE ports (10/100/1000Mbps), Four SFP+ ports (10GE), Layer 3 Stackable Managed Switch.  |

- All the switches are equipt with one RJ-45 Console port (a special console cable with a DB9 interface is provided to connect the Switch to a PC)
- All the switches are equipt with one Redundant Power Supply (RPS) outlet for optional external RPS
- All the switches are also equipt with one Alarm Port and SD Card Slot.



**NOTE:** For customers interested in D-View, D-Link Corporation's proprietary SNMP management software, go to <http://dview.dlink.com.tw/> and download the software and manual.

# Front-Panel Components

The front panel of the DGS-3620 Series consists of a Management and Console port, LED indicators for Power, Console, an Alarm Port, and stacking ID LED's. A separate table below describes LED indicators in more detail.

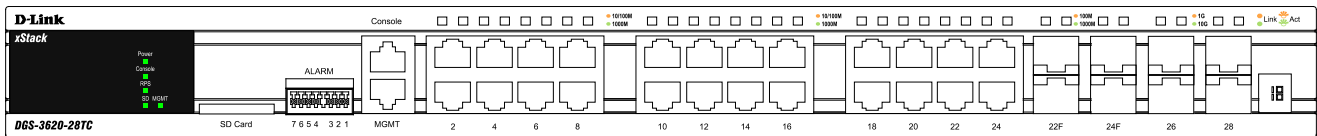

Figure 1-1 Front panel view of a DGS-3620-28TC Switch

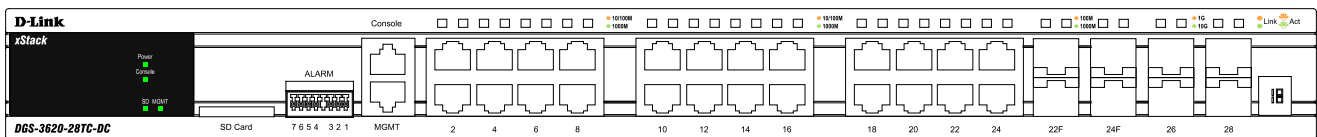

Figure 1-2 Front panel view of a DGS-3620-28TC-DC Switch

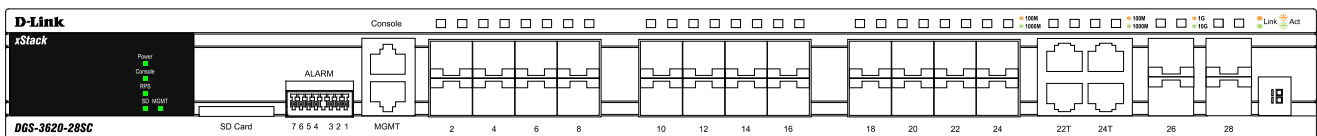

Figure 1-3 Front panel view of a DGS-3620-28SC Switch

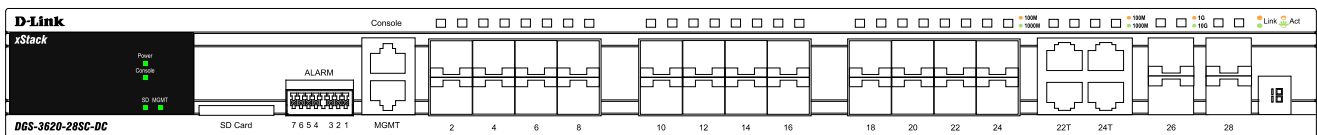

Figure 1-4 Front panel view of a DGS-3620-28SC-DC Switch

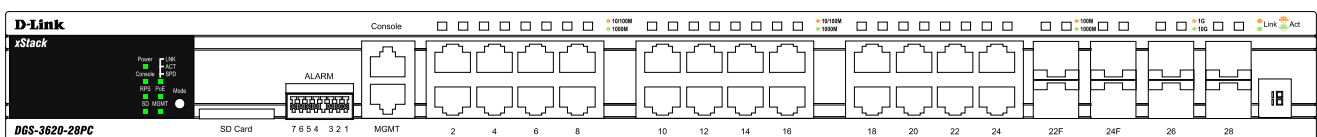

Figure 1-5 Front panel view of a DGS-3620-28PC Switch

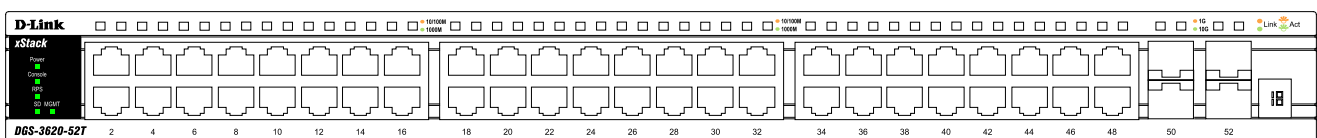

Figure 1-5 Front panel view of a DGS-3620-52T Switch

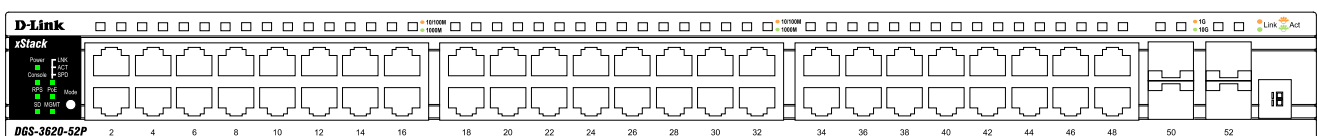

Figure 1-6 Front panel view of a DGS-3620-52P Switch

## LED Indicators

The Switch front panel presents LED indicators for Power, Console, RPS, Master (stack control), SD, Stack ID and Link/Act indicators for all ports including the Gigabit Ethernet ports. The DGS-3620-28PC and DGS-3620-52P switches are equipt with an additional PoE light, to indication whether the ports are running in Power over Ethernet mode.

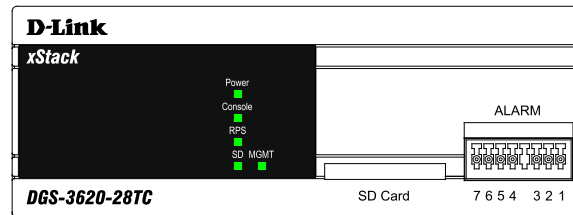

Figure 1–7 LED indicators for a DGS-3620-28TC Switch

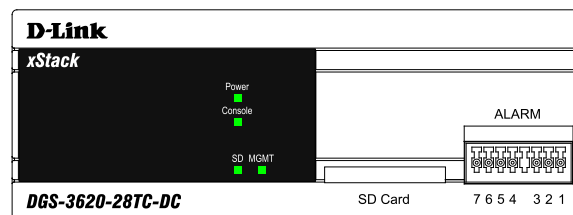

Figure 1–8 LED indicators for a DGS-3620-28TC-DC Switch

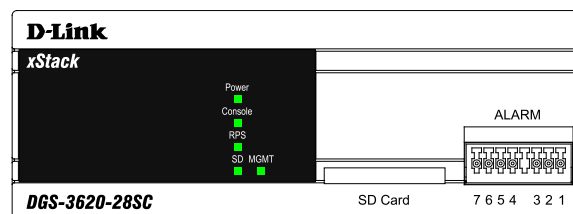

Figure 1–9 LED indicators for a DGS-3620-28SC Switch

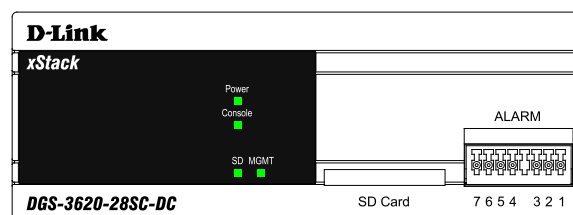

Figure 1–10 LED indicators for a DGS-3620-28SC-DC Switch

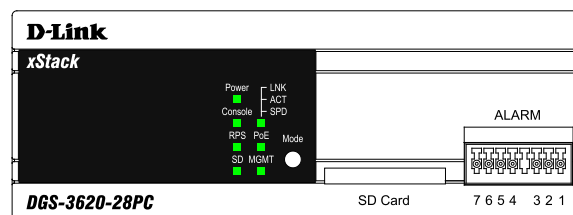

Figure 1–11 LED indicators for a DGS-3620-28PC Switch

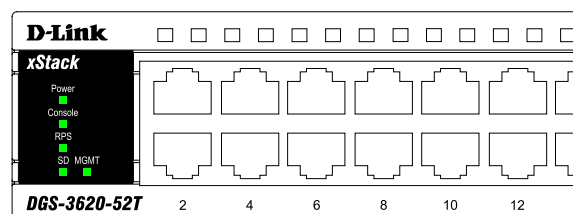

Figure 1–12 LED indicators for a DGS-3620-52T Switch

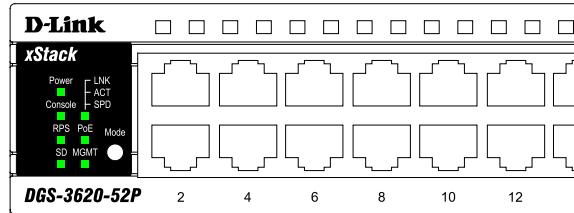

Figure 1–13 LED indicators for a DGS-3620-52P Switch

| LED                  | Description  |
|----------------------|--|
| <b>Power</b>         | This LED will light green after powering the Switch on to indicate the ready state of the device. The indicator is dark when the Switch is no longer receiving power (i.e. powered off).   |
| <b>Console</b>       | This LED will blink green during the Power-On Self Test (POST). When the POST is finished, the LED goes dark. The indicator will light steady green when a user is logged in through the console port.   |
| <b>RPS</b>           | This LED will light green if the Redundant Powers Supply is in use. If the indicator is off, the RPS is not in use. When the switch detects that the RPS is connected, the light will be blinking.   |
| <b>SD</b>            | This LED will light green if a Secure Digital (SD) card is plugged in. When the Switch is reading or writing, the indicator will blink green. No light LED means there is no link. A solid red LED indicates SD card failure.  |
| <b>Stack ID</b>      | For standalone Switches, this will display number “1”. For stacked Switches, this indicates the position in the stacking box ID. The box ID is assigned either by the user (static mode) or by the system (automatic mode). When “1” to “12” is displayed, this indicates the stacking position of the switch. An “H” indicates the device was assigned as the stacking Master. “h” means the device was selected to be the Backup Master. A “G” is displayed when the Safeguard Engine feature enters the exhausted mode. |
| <b>Link/Act LEDs</b> | The Switch has LED indicators for Link and Activity. The LED will light steady green when there is a secure connection (or link) to a 1000Mbps Ethernet device at any of the ports, or steady orange when there is a secure connection (or link) to a 10/100Mbps Ethernet device at any of the ports. The LED will blink green when a 1000Mbps port is active, or blink orange when a 10/100Mbps port is active. The LED remains dark when there is no link or activity.   |
| <b>PoE</b>           | Only the DGS-3620-28PC and the DGS-3620-52P switches are equip with a PoE LED. When this light is on with a solid green light, it means that the corresponding ports are feeding power to the PoE devices plugged in. When this light is on with a solid orange light, it means that the port is in an error condition state. When this light is off, it means that the ports are not supplying power to the devices plugged into the ports.   |

For more information about LED Indicators, refer to [LED Indicators](#).

## Rear Panel Description

The rear panel contains an AC/DC power connector and an outlet for an external redundant power supply.

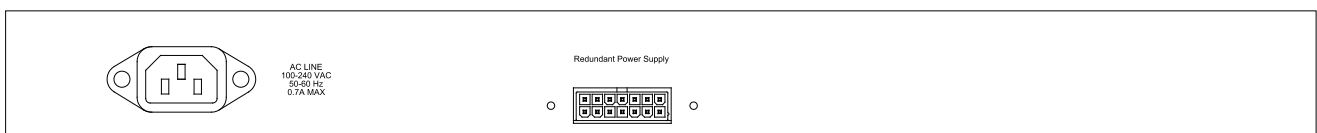

Figure 1–14 Rear panel view of a DGS-3620-28TC Switch

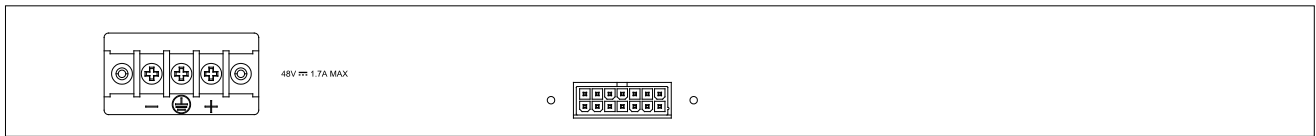

Figure 1-15 Rear panel view of a DGS-3620-28TC-DC Switch

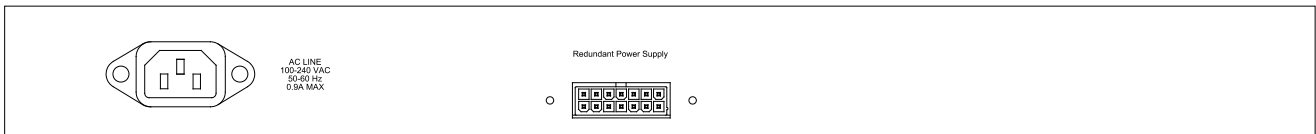

Figure 1-16 Rear panel view of a DGS-3620-28SC Switch

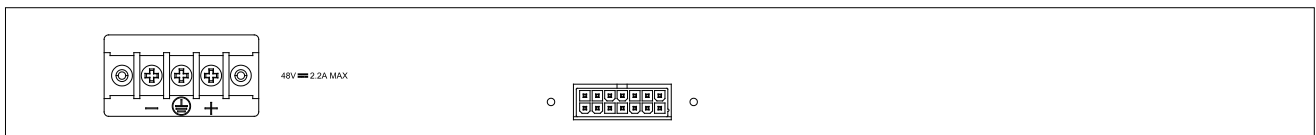

Figure 1-17 Rear panel view of a DGS-3620-28SC-DC Switch

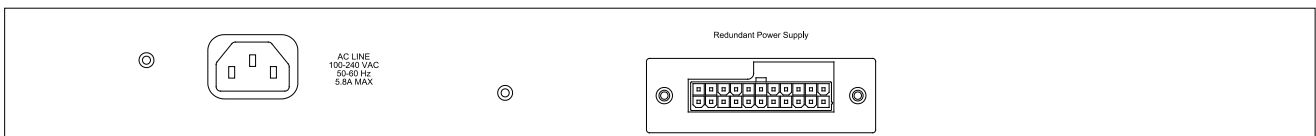

Figure 1-18 Rear panel view of a DGS-3620-28PC Switch

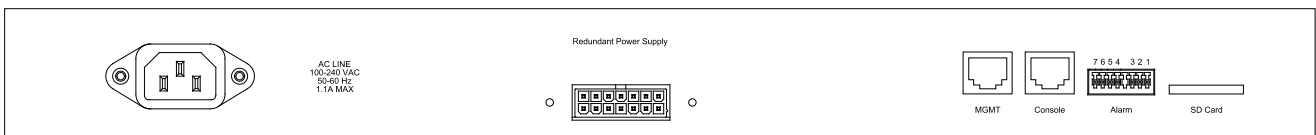

Figure 1-19 Rear panel view of a DGS-3620-52T Switch

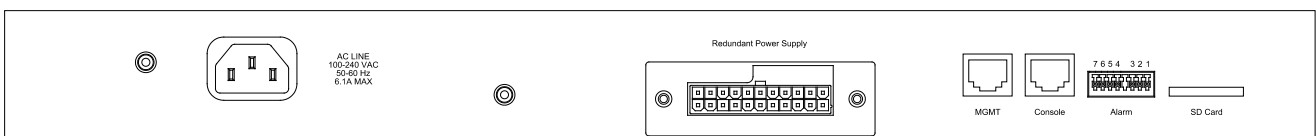

Figure 1-20 Rear panel view of a DGS-3620-52P Switch

The AC power connector is a standard three-pronged connector that supports the power cord. Plug-in the female connector of the provided power cord into this socket, and the male side of the cord into a power outlet. The Switch automatically adjusts the power setting to any supply voltage in the range from 100~240 VAC at 50~60 Hz. An optional external Redundant Power Supply (DPS-500 for DGS-3620-28TC/28SC/26SC/52T, DPS-700 for DGS-3620-28PC/52P) can be plugged into the RPS outlet displayed above. When the internal power fails, this optional external RPS will take over all the power immediately and automatically.

## Side Panel Description

The system heat vents located on the sides of the DGS-3620-Series of switches dissipate heat. Do not block these openings. Leave at least 6 inches of space at the rear and sides of the Switch for proper ventilation. Without proper heat dissipation and air circulation, system components might overheat which could lead to system failure or even severely damaged components.

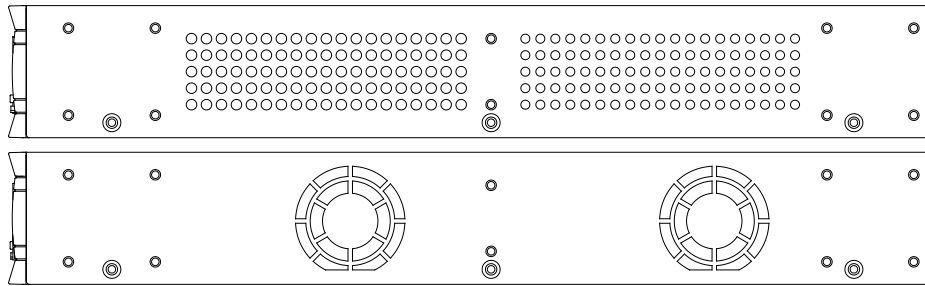

Figure 1–21 Side panels view of a DGS-3620-28TC Switch

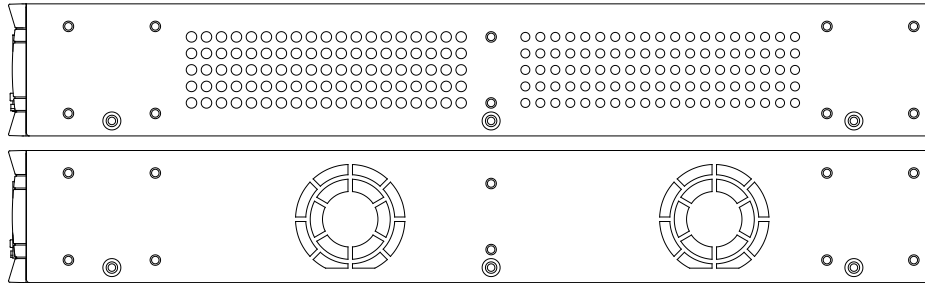

Figure 1–22 Side panels view of a DGS-3620-28TC-DC Switch

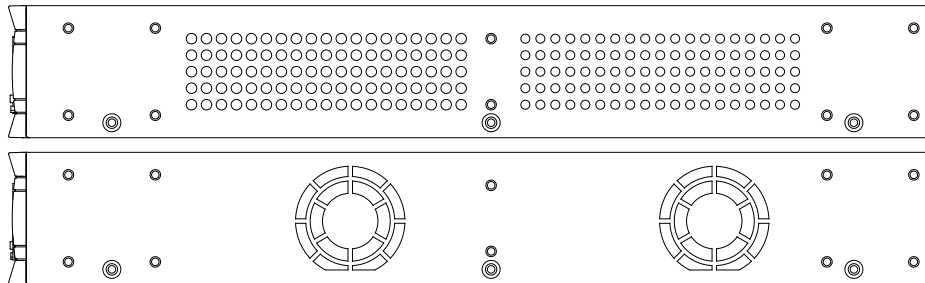

Figure 1–23 Side panels view of a DGS-3620-28SC Switch

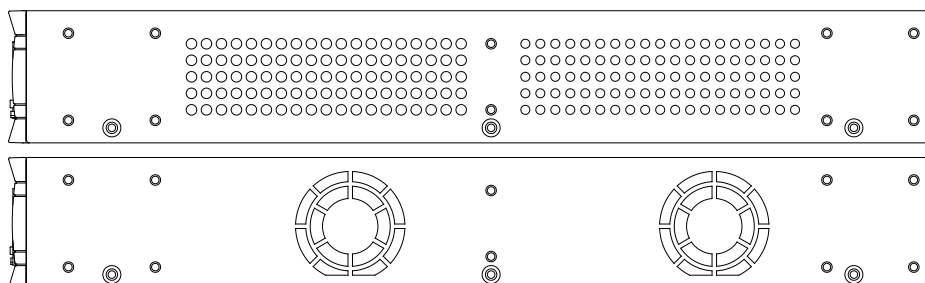

Figure 1–24 Side panels view of a DGS-3620-28SC-DC Switch



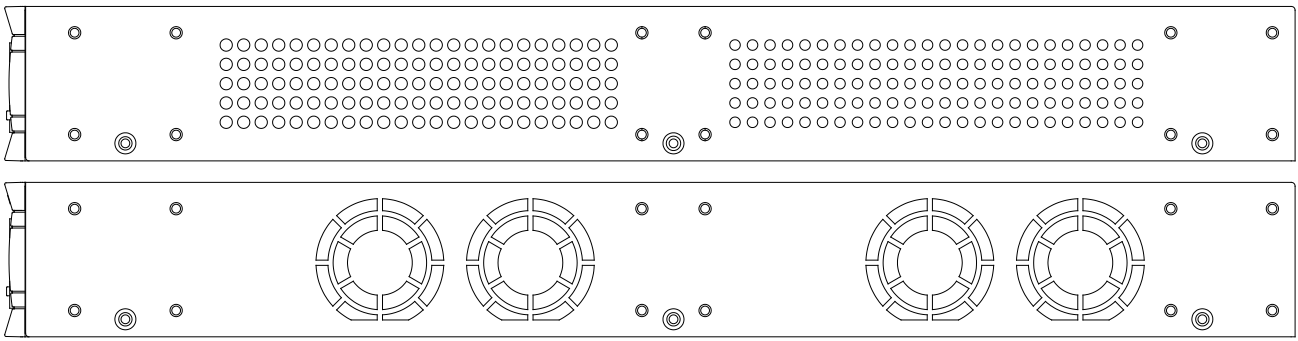

Figure 1–25 Side panels view of a DGS-3620-28PC Switch

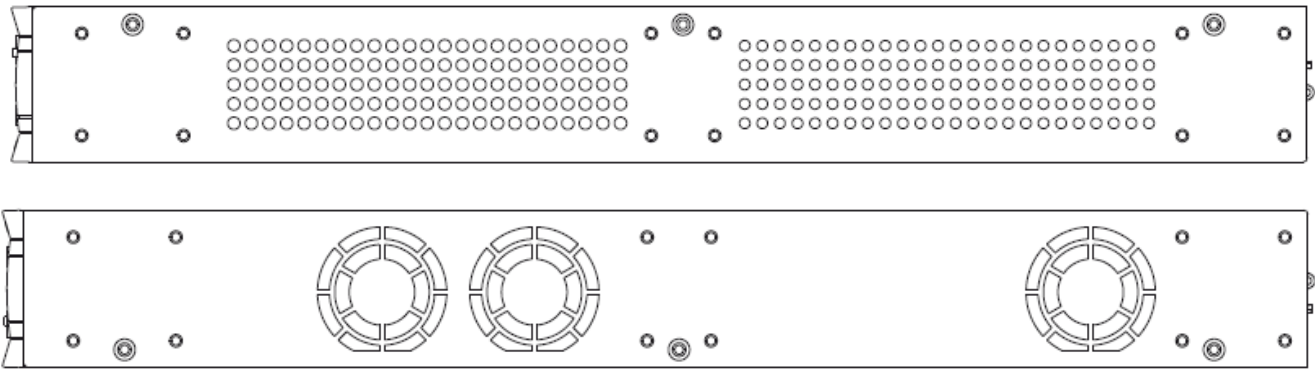

Figure 1–26 Side panels view of a DGS-3620-52T Switch

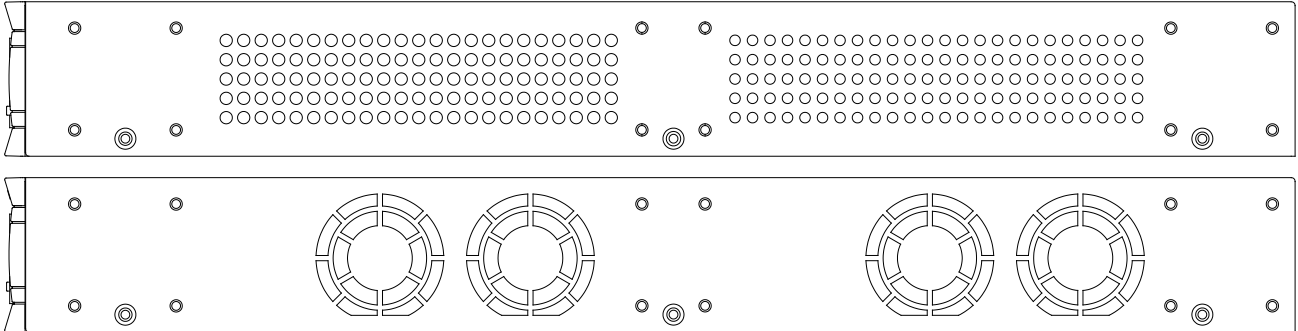

Figure 1–27 Side panels view of a DGS-3620-52P Switch

## Chapter 2 Installation

### **Package Contents**

### **Installation Guidelines**

### **Power On (AC Power)**

### **Alarm Connector**

### **Installing SFP and SFP+ Ports**

### **Connecting to a Redundant Power Supply**

### **External Redundant Power System**

## Package Contents

Open the shipping carton of the Switch and carefully unpack its contents. The carton should contain the following items:

- One DGS-3620 Series Switch
- One AC power cord (this depends on the type of DGS-3620 being shipped). The DC version wouldn't need AC power.
- One RJ-45 to RS-232 console cable
- One mounting kit (two brackets and screws)
- Four rubber feet with adhesive backing
- One CD kit for CLI reference guide/Web UI reference guide/Hardware Installation Guide/D-View module

If any item is missing or damaged, please contact your local D-Link Reseller for replacement.

## Installation Guidelines

Please follow these guidelines for setting up the Switch:

- Install the Switch on a sturdy, level surface that can support at least 6.6 lb. (3kg – This is without PoE functionality) of weight. Do not place heavy objects on the Switch.
- The power outlet should be within 1.82 meters (6 feet) of the Switch.
- Visually inspect the power cord and see that it is fully secured to the AC power port.
- Make sure that there is proper heat dissipation from and adequate ventilation around the Switch. Leave at least 10 cm (4 inches) of space at the front and rear of the Switch for ventilation.
- Install the Switch in a fairly cool and dry place for the acceptable temperature and humidity operating ranges.
- Install the Switch in a site free from strong electromagnetic field generators (such as motors), vibration, dust, and direct exposure to sunlight.
- When installing the Switch on a level surface, attach the rubber feet to the bottom of the device. The rubber feet cushion the Switch, protect the casing from scratches and prevent it from scratching other surfaces.

## Installing the Switch without a Rack

First, attach the rubber feet included with the Switch if installing on a desktop or shelf. Attach these cushioning feet on the bottom at each corner of the device. Allow enough ventilation space between the Switch and any other objects in the vicinity.

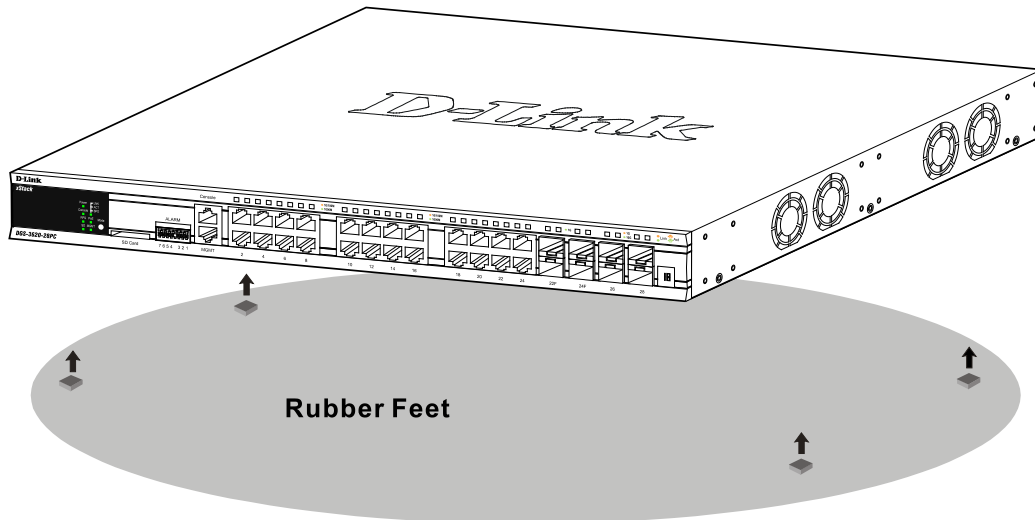

Figure 2-1 Attach rubber feet to the Switch.

## Attaching Brackets to a Switch for Rack Mounting

The Switch is mounted to a standard 19" rack using mounting brackets. Use the following diagrams as a guide.

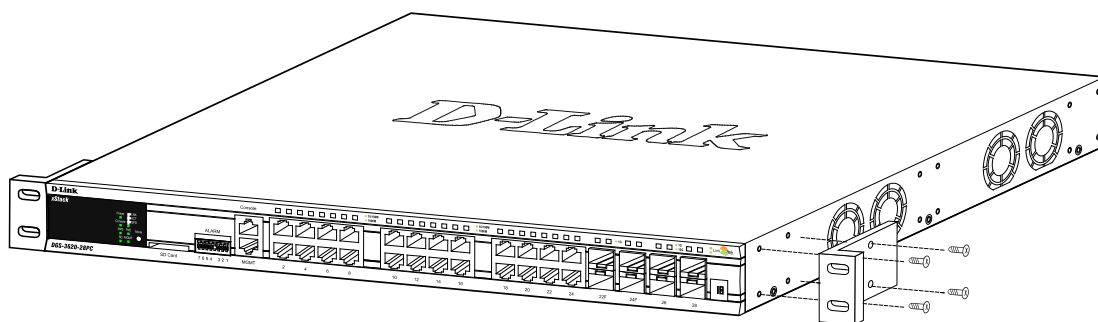

Figure 2-2 Attach mounting brackets to the Switch

Fasten the mounting brackets to the Switch using the screws provided. With the brackets attached securely, the Switch can be mounted in a standard rack, as shown below.



**Note:** Please review the Installation Guidelines above before installing the Switch in a rack. Make sure there is adequate space around the Switch to allow for proper air flow, ventilation and cooling.

## Mounting the Switch in a Standard 19" Rack

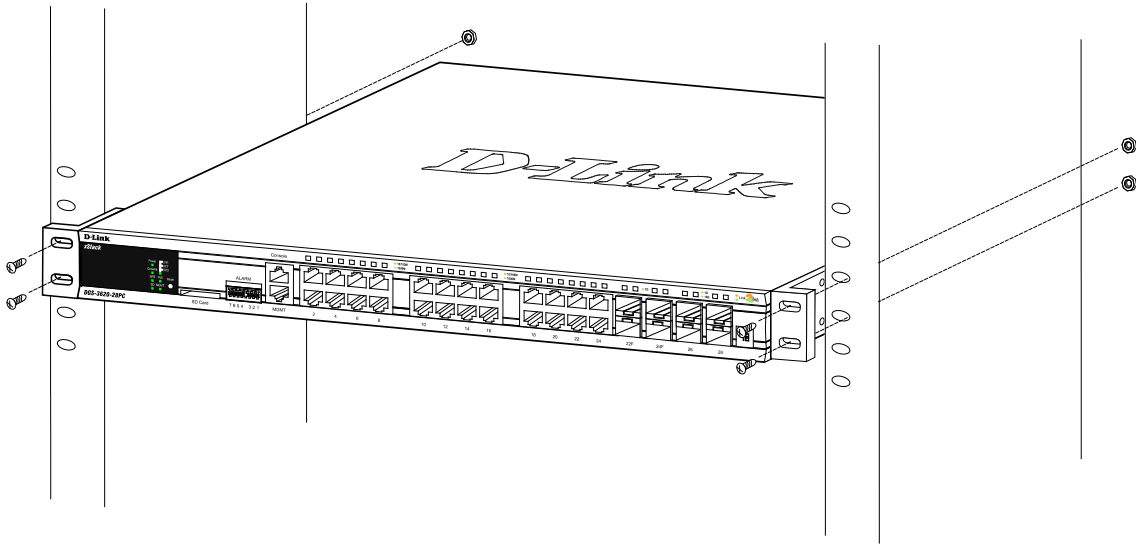

Figure 2-3 Mount the Switch in a rack

## Power On (AC Power)

Plug one end of the AC power cord into the power connector of the Switch and the other end into the local power source outlet. Once the system powered on, the LED's blink green to indicate that the system is resetting.

## Power Failure (AC Power)

In the event of a power failure, just as a precaution, unplug the Switch. After the power returns, plug the switch back in to the power socket.



**CAUTION:** Installing systems in a rack without the front and side stabilizers installed could cause the rack to tip over, potentially resulting in bodily injury under certain circumstances. Therefore, always install the stabilizers before installing components in the rack. After installing components in a rack, do not pull more than one component out of the rack on its slide assemblies at one time. The weight of more than one extended component could cause the rack to tip over and may result in injury.

## Alarm Connector

The alarm connector can be used to use external devices when triggered events occur.

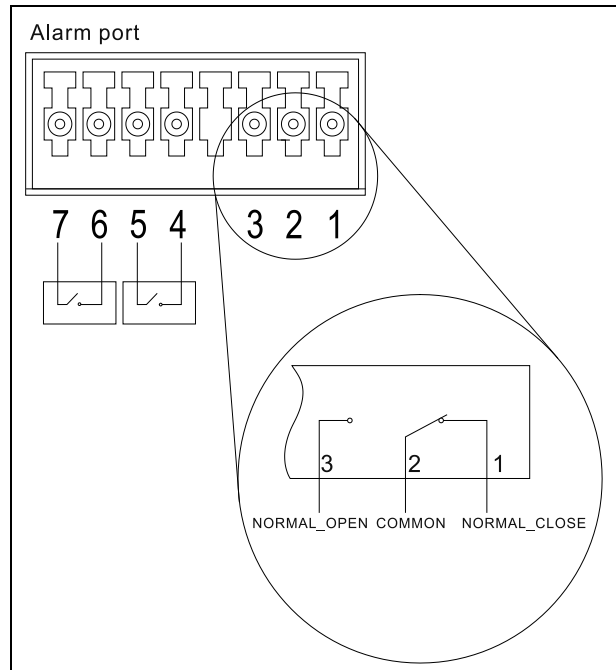

Figure 2-4 Alarm Connector

| Alarm Connector Port |   |
|----------------------|---|
| Contact              | Description                                 |
| 1                    | Output. Normal Closed Pin. (42VAC or 60VDC) |
| 2                    | Output. Common Pin. (42VAC or 60VDC)        |
| 3                    | Output. Normal Open Pin. (42VAC or 60VDC)   |
| 4                    | Input 2                                     |
| 5                    | Input 2                                     |
| 6                    | Input 1                                     |
| 7                    | Input 1                                     |

Connect the alarm input pins to alarm output terminals on other pieces of equipment.  
 Connect the alarm output pins to alarm input terminals on other pieces of equipment.

## Installing SFP and SFP+ Ports

The Switch is equipped with SFP (Small Form Factor Portable) and SFP+ ports, which are used with fiber-optical transceiver cabling. SFP ports support full-duplex transmissions, auto-negotiation, and can be uplinked with various other switches across a gigabit network. The SFP ports support data rates of up to 1Gbit/s and the SFP+ ports support data rates of up to 10Gbit/s.

See the figure below for installing the SFP ports in the Switch.

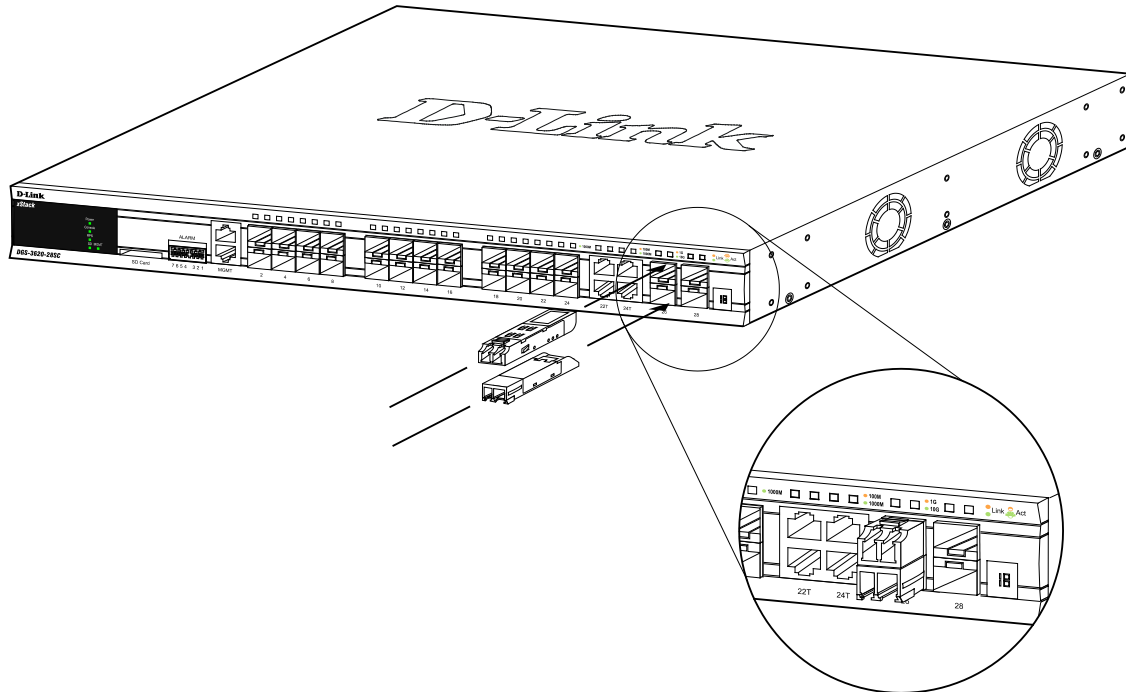

Figure 2-5 Inserting fiber-optic transceivers into a DGS-3620 Series Switch

For a full list of supported transceivers, compatible with this switch series, refer to [Port Functions](#).

## Connecting to a Redundant Power Supply

The DGS 3620 Series switch connects to the Master Switch using a 14-pin DC power cable. A standard, three-pronged AC power cable connects the redundant power supply to the main power source.

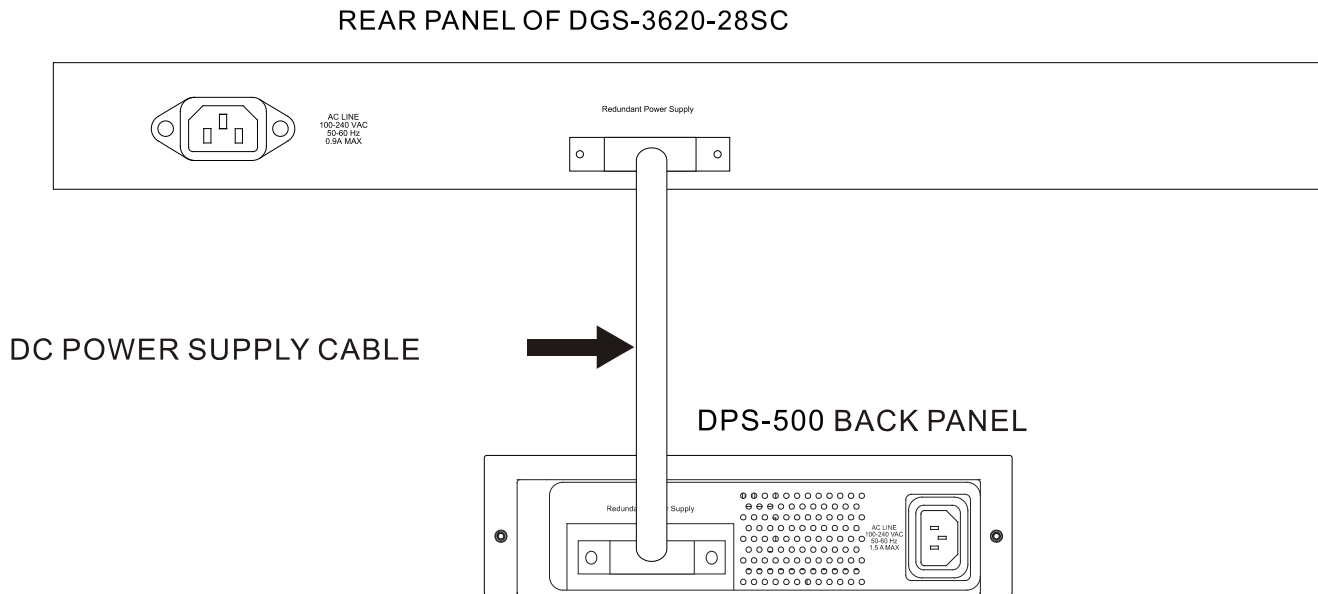

Figure 2–6 Connecting a DGS-3620 Series Switch to the DPS-500

1. Insert one end of the 14-pin DC power cable into the port on the switch and the other end into the redundant power supply.
2. Using a standard AC power cable, connect the redundant power supply to the main AC power source. A green LED on the front of the DPS-500 will glow to indicate a successful connection.
3. Re-connect the switch to the AC power source. The LED indicator will show that a redundant power supply is now in operation.
4. Do not make any changes on the switch.



**Note:** See the DPS-500 documentation for more information.



**CAUTION:** The DGS-3620-28TC-DC/28SC-DC doesn't support any redundant power system. Only the DGS-3620-28TC, DGS-3620-28SC & the DGS-3620-52T use DPS500. The DGS-3620-28PC and the DGS-3620-52P use the DPS700.

## External Redundant Power System

The DPS-500/700 is a redundant power-supply unit designed to conform to the voltage requirements of the switches being supported. The DPS-500/700 can be installed into a DPS-900, or DPS-800 rack mount unit.



**CAUTION:** DO NOT connect the RPS to AC power before the DC power cable is connected. This might damage the internal power supply. The DPS-500 only works on the DGS-3620-28TC/28SC/52T, whereas the DPS-700 only supports the DGS-3620-28PC/52P.

### DPS-900

The DPS-900 is a standard-size rack mount (5 standard units in height) designed to hold up to eight DPS-500 redundant power supplies. However, it cannot hold eight DPS-700 modules.

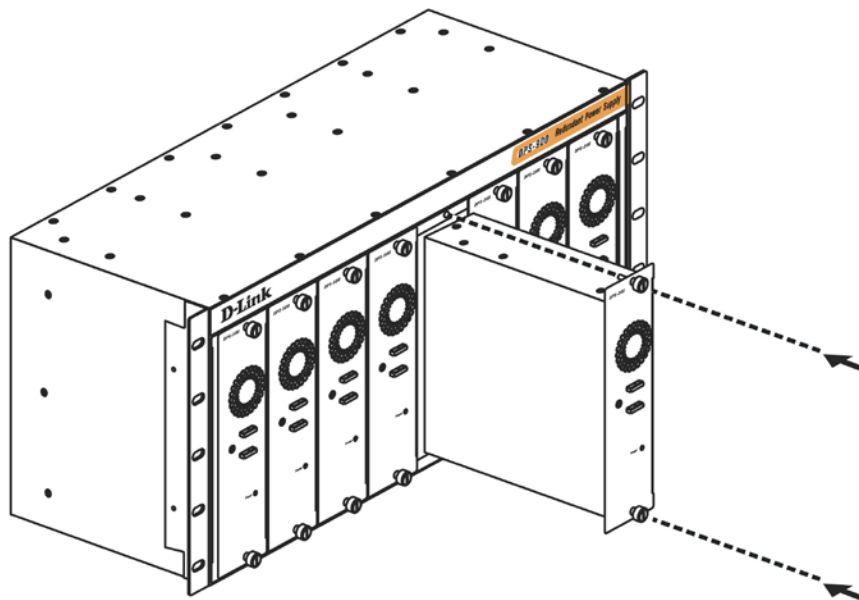

Figure 2-7 Inserting the DPS-500 into the DPS-900

The RPS can be mounted in a standard 19" rack. Use the following diagram to guide you.



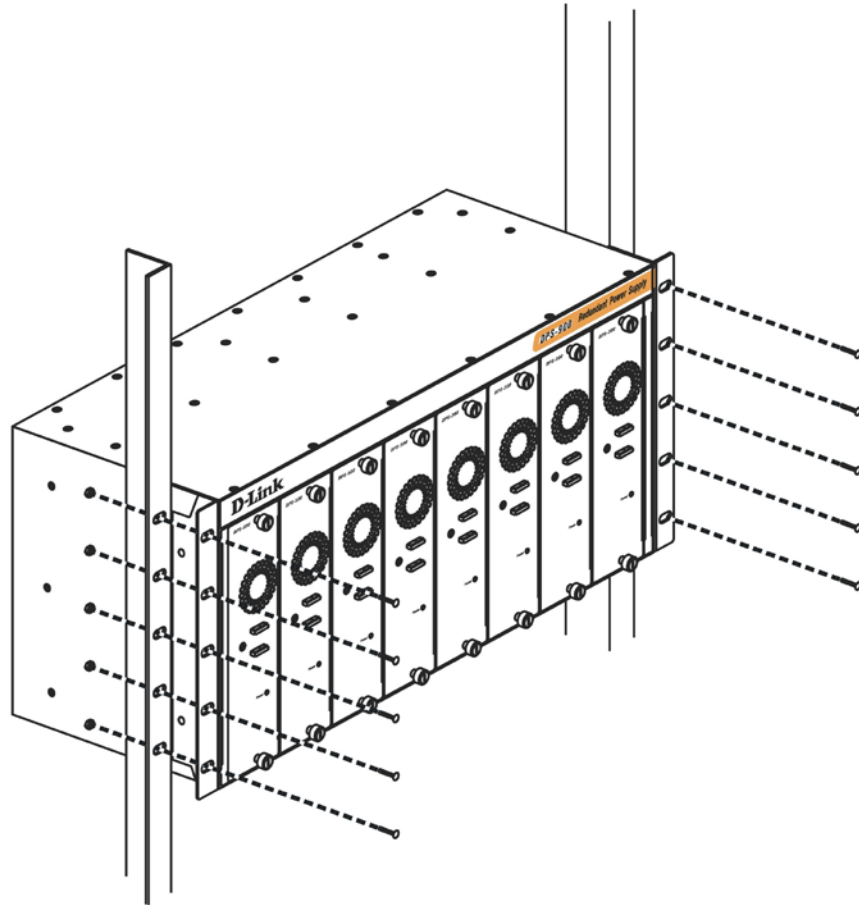

Figure 2-8 Install the DPS-900 into the equipment rack



**CAUTION:** Installing systems in a rack without the front and side stabilizers installed could cause the rack to tip over, potentially resulting in bodily injury under certain circumstances. Therefore, always install the stabilizers before installing components in the rack. After installing components in a rack, do not pull more than one component out of the rack on its slide assembly at a time. The weight of more than one extended component could cause the rack to tip over and may result in injury.

## DPS-800

The DPS-800 is a standard-size rack mount (1 standard unit in height) designed to hold up to two DPS-200, DPS-300, and DPS-500 redundant power supplies.

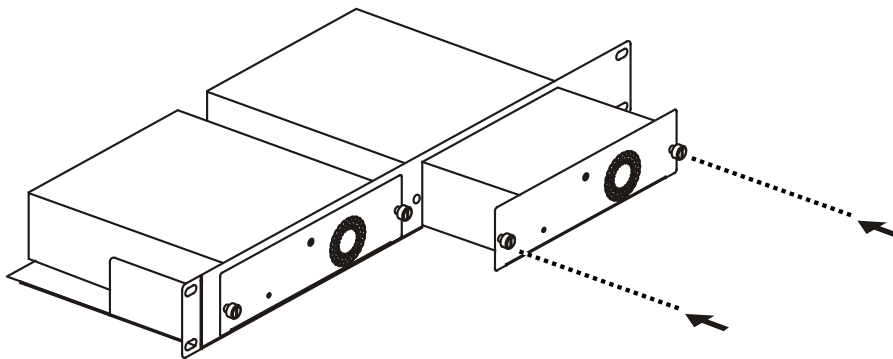
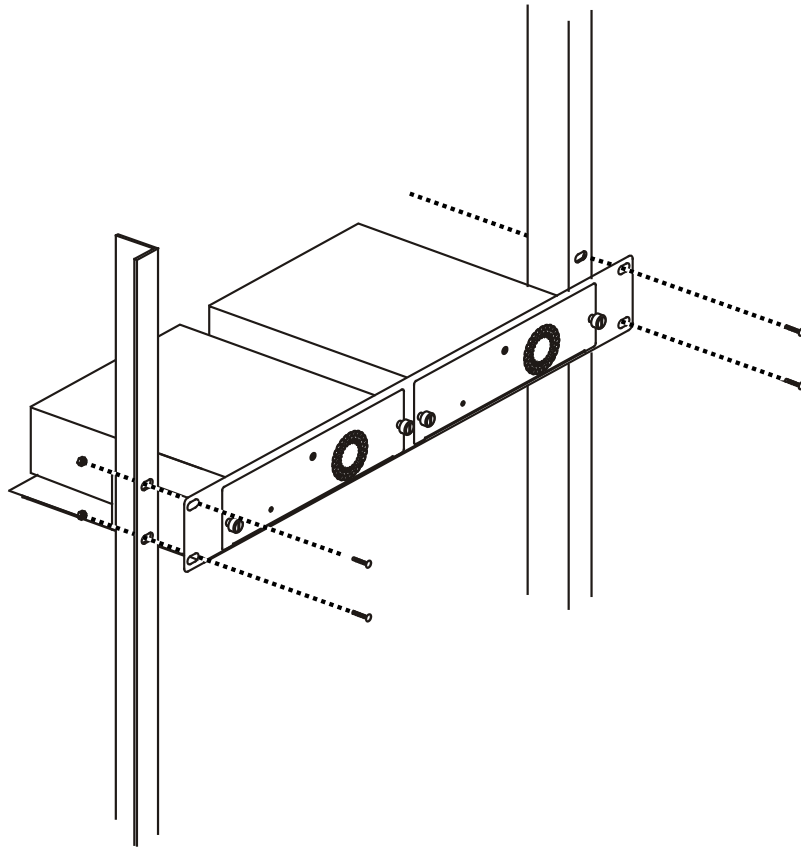

Figure 2-9 Install the DPS-500 in the DPS-800

The RPS can be mounted in a standard 19" rack. Use the following diagram to guide you.



**Figure 2–10 Install the DPS-800 in an Equipment Rack**

# Chapter 3 Connecting the Switch

## Switch to End Node

### Switch to Switch

### Connect to a Network Backbone or Server



**Note:** All high-performance N-Way Ethernet ports can support both MDI-II and MDI-X connections.

## Switch to End Node

End nodes include PCs outfitted with a 10/100/1000 Mbps RJ-45 Ethernet Network Interface Card (NIC) and routers. An end node connects to the Switch via a twisted-pair UTP/STP cable. Connect the end node to any of the 1000BASE-T ports of the Switch. The Link/Act LEDs for each Ethernet port turns green or amber when the link is active. A blinking LED indicates packet activity on that port.

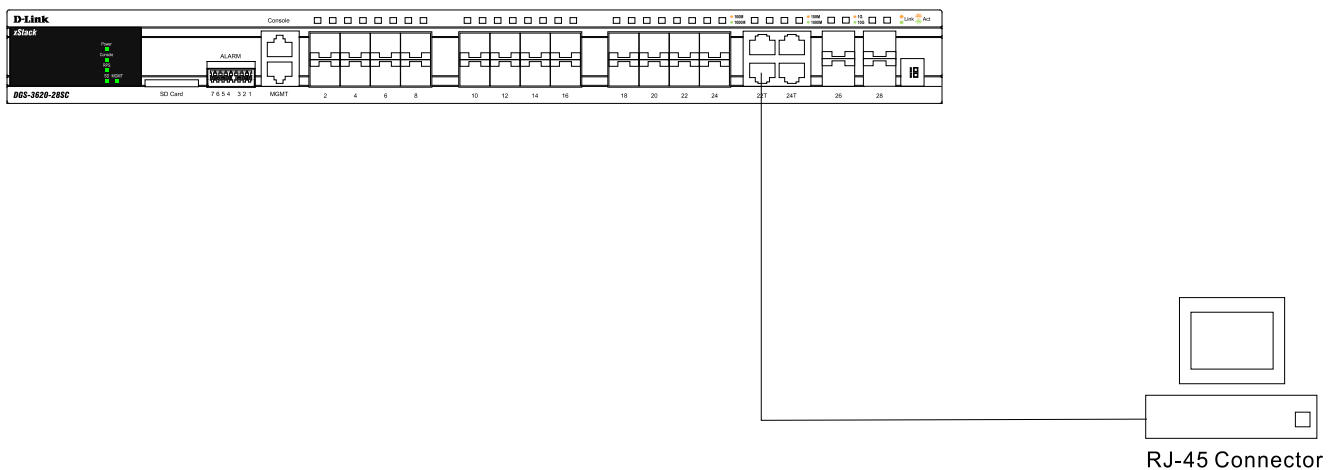

Figure 3–1 Connect a DGS-3620 Series Switch to an end node

## Switch to Switch

There is a great deal of flexibility on how connections are made using the appropriate cabling.

- Connect a 10BASE-T switch port to the Switch via a twisted-pair Category 3, 4 or 5 UTP/STP cable.
- Connect a 100BASE-TX switch port to the Switch via a twisted-pair Category 5 UTP/STP cable.
- Connect 1000BASE-T switch port to the Switch via a twisted pair Category 5e UTP/STP cable.
- Connect switch supporting a fiber-optic uplink to the Switch's SFP ports via fiber-optic cabling.

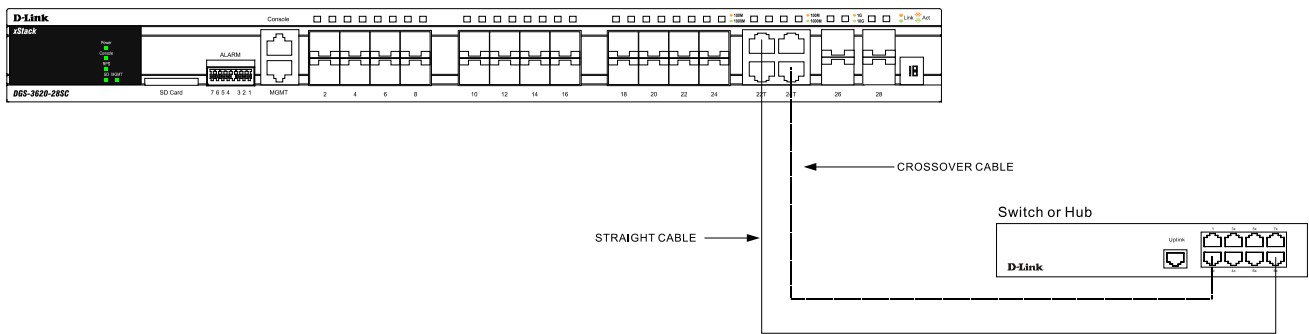

Figure 3-2 Connect the Switch to a port on a switch with a straight or crossover cable

## Connect to a Network Backbone or Server

The combo SFP ports and the 1000BASE-T ports are ideal for uplinking to a network backbone, server or server farm. The copper ports operate at a speed of 10/100/1000Mbps in half or full duplex mode. The fiber-optic ports can operate at both 100Mbps and 1000Mbps in full duplex mode.

You can connect to the Gigabit Ethernet ports using a fiber-optic cable or a Category 5E copper cable, depending on the type of port. The Link LED turns green when a connection is made.

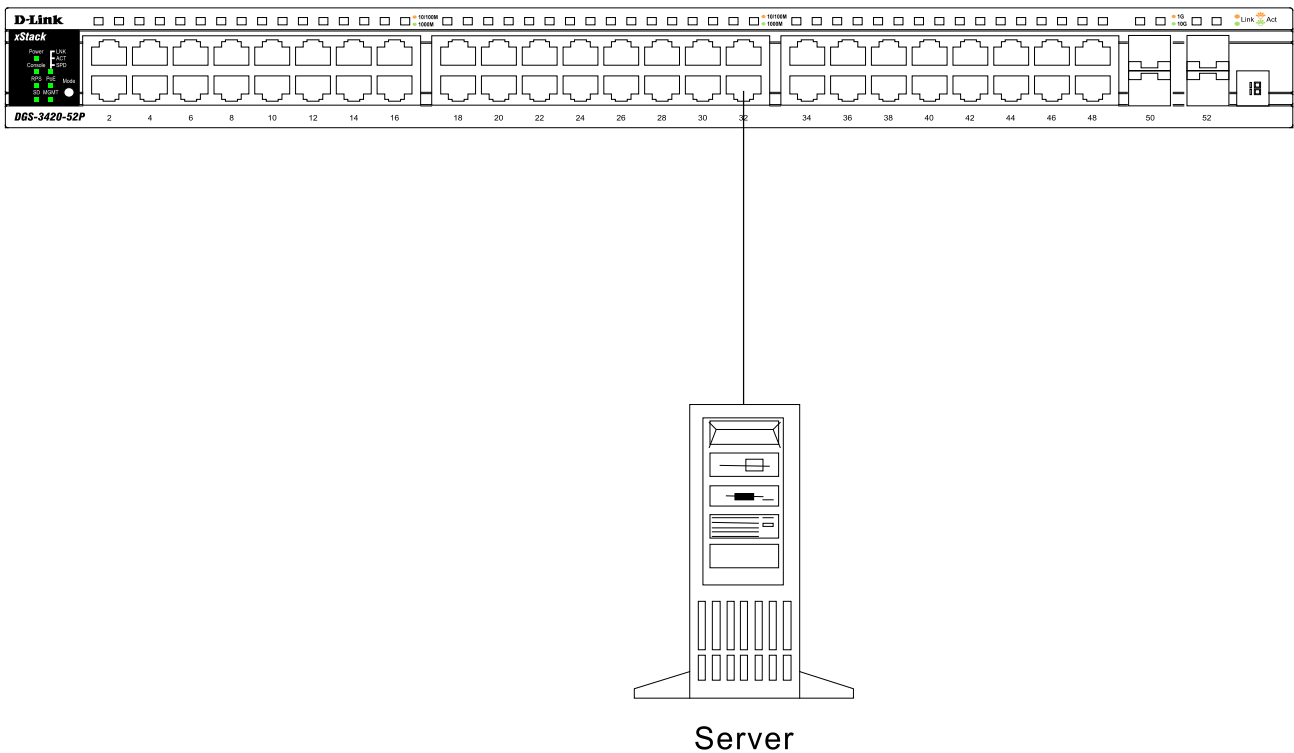

Figure 3-3 Connect a DGS-3620 Series Switch to a server

# Chapter 4 Introduction to Switch Management

## **Management Options**

### **Connecting the Console Port**

### **Connecting to the Switch for the First Time**

### **Connecting to the Management Port**

### **Password Protection**

### **Assigning IP Addresses**

### **SNMP Settings**

## Management Options

This system may be managed out-of-band through the console port on the front panel or in-band using Telnet. The user may also choose the web-based management, accessible through a web browser.

### **Web-based Management Interface**

After successfully installing any of the DGS-3620 Series switches, the user can configure the Switch, monitor the LED panel, and display statistics graphically using a web browser, such as FireFox (version 3.0 and higher) or Microsoft® Internet Explorer (version 5.0 and higher).

### **SNMP-Based Management**

The DGS-3620-Series of switches are also managed with an SNMP-compatible console program. The DGS-3620-Series supports SNMP version 1.0, 2.0 and 3.0. The SNMP agent decodes the incoming SNMP messages and responds to requests with MIB objects stored in the database. The SNMP agent updates the MIB objects to generate statistics and counters.

### **Command Line Interface Management through the Serial Port or remote Telnet**

The user can also connect a computer or terminal to the serial console port to access the DGS-3620 range. The command line interface provides complete access to all DGS-3620 Series of switches management features.

## Connecting the Console Port

The console port on the front panel of the DGS-3620 Series is used to connect a computer that monitors and configures the switch. The console port is an RJ-45 port and requires a special cable that is included with the switch, to establish the physical connection.

To use the console port, the following equipment is needed:

- A terminal or a computer with both an RS-232 serial port and the ability to emulate a terminal.
- A console cable with a male DB-9 connector on one end and an RJ-45 connection on the other. This cable should be included with any of the DGS-3620 Series. It establishes the physical connection to the console port.

### **To connect a terminal to the console port:**

Connect the male DB-9 connector on the console cable (shipped with the DGS-3620-28SC for example) to the RS-232 serial port on the computer running terminal emulation software then insert the RJ-45 connector into the RJ-45 console port on the front of the switch. Set the terminal emulation software as follows:

- Select the appropriate serial port (COM port 1 or COM port 2).
- Set the data rate to 115200 baud.
- Set the data format to 8 data bits, 1 stop bit, and no parity.
- Set flow control to none.
- Under Properties, select VT100 for Emulation mode.

- Select Terminal keys for Function, Arrow and Ctrl keys. Make sure to use Terminal keys (not Windows keys) are selected.



**Note:** When using HyperTerminal with the Microsoft® Windows® 2000 operating system, ensure that Windows 2000 Service Pack 2 or later is installed. Windows 2000 Service Pack 2 allows the use of arrow keys in HyperTerminal's VT100 emulation. See [www.microsoft.com](http://www.microsoft.com) for information on Windows 2000 service packs.

- After you have correctly set up the terminal, plug the power cable into the power socket on the back of the DGS-3620 Series switch. The boot sequence appears in the terminal.
- After the boot sequence completes, the console login screen displays.
- If the user has not logged into the command line interface (CLI) program, press the Enter key at the User name and password prompts. There is no default user name and password for the Switch. The administrator must first create user names and passwords. If user accounts have been previously set up, log in and continue to configure the Switch.
- Enter the commands to complete the desired tasks. Many commands require administrator-level access privileges. Read the next section for more information on setting up user accounts. See the *DGS-3620 Series CLI Reference Guide* on the documentation CD for a list of all commands and additional information on using the CLI.
- To end a management session, use the logout command or close the emulator program.

If you experience problems while making a connection, make sure the emulation is set to VT-100. The emulation settings can be configured by:

1. Click File Menu in HyperTerminal
2. Click Properties from the drop-down menu
3. Click the Settings Tab

This is where you will find the Emulation options. If you still do not see anything, try rebooting the Switch by disconnecting its power supply.

Once connected to the console, the image in Figure 4-1 appears. This is where the user will enter commands to perform all the available management functions. The DGS-3620-Series Switch will prompt the user to enter a user name and password. Logging on at the beginning requires no username or password. Just press the Enter key twice to access the command line interface.

```

Boot Procedure                                     V1.00.016
-----
Power On Self Test ..... 100 %

MAC Address   : 00-01-02-03-04-00
H/W Version   : B1

Please Wait, Loading V2.60.016 Runtime Image ..... 100 %
UART init ..... 100 %
Starting runtime image
Device Discovery ..... 100 %
Configuration init ..... 100 %

Press any key to login...
    
```

Figure 4-1 Boot up display in console screen

## Connecting to the Switch for the First Time

The DGS-3620 Series Switch supports user-based security that prevents unauthorized users from accessing the switch or changing its settings. This section explains how to log into the DGS-3620 Series Switch from an out-of-band Management port connection.

Once you have connected to the DGS-3620 Series Switch, the following screen appears (see Figure 4-2).

```
DGS-3620-28SC Gigabit Ethernet Switch
Command Line Interface

Firmware: Build 2.60.016
Copyright(C) 2013 D-Link Corporation. All rights reserved.

UserName :
```

Figure 4-2 Initial screen, first time connecting to the Switch

- Leave the username parameter blank and press Enter
- Leave the password parameter blank and press Enter
- The command prompt reads: **DGS-3620-28SC:admin#** - Type the switch commands once you have reached this stage.



**NOTE:** The first user automatically gets Administrative privileges. At least one Admin-level user account must be created for the DGS-3620 Series Switch.

## Connecting to the Management Port

The front panel of the DGS-3620 Series Switch features an out-of-band RJ-45 Management port which can easily connect to a notebook. Connect to the out-of-bound management console using a web browser or Telnet command prompt interface. This is the default login interface, and is the tool you can use when connecting to the DGS-3620 Series Switch for the first time.

To use the Management port, connect one end of an Ethernet cable to a computer and the other to the switch. The default IP address of the Management port is 192.168.0.1, and a subnet mask of 255.255.255.0. Make sure that the computer being used for Switch management has a nonconflicting IP address in the 192.168.0.x subnet.

The IP settings or enabled status of the Management port can be changed through the console port, or through the web-based Switch management interface. To change the configuration of the Management port, use the command:

```
config out_band_ipif {ipaddress <network_address> | state [enable | disable] | gateway <ipaddr>}
```

To view the status or IP settings, use the command:

```
show out_band_ipif
```

To change settings for the out-of-band Management port in the web interface, use the following path:

**Management > Out of Band Management Settings**

## Password Protection

The DGS-3620 Series Switches do not have a default user name and password. One of the first tasks when settings up the Switch is to create user accounts. Logging in using a predefined administrator-level user name will give the user privileged access to the Switch's management software.

After the initial login, define new passwords for both default user names to prevent unauthorized access to the Switch, and record the passwords for future reference.

To create an administrator-level account for the Switch, do the following:

1. At the CLI login prompt, enter **create account admin** followed by the **<username>** and press the **Enter** key.
2. The Switch will then prompt the user to provide a password. Type the administrator **<password>** and press the **Enter** key.
3. Once entered, the Switch will again ask the user to insert the same password again to verify it. Type the same password and press the **Enter** key.
4. A new administrative account is created once the "Success." prompt appears.



**Note:** Passwords are case sensitive. User names and passwords can be up to 15 characters in length.

The sample below illustrates a successful creation of a new administrator-level account with the user name "newmanager".

```
DGS-3620-28SC:admin# create account admin newmanager
Command: create account admin newmanager

Enter a case-sensitive new password:*****
Enter the new password again for confirmation:*****
Success.

DGS-3620-28SC:admin#
```

Figure 4-3 Create account command



**NOTICE:** CLI configuration commands only modify the running configuration file and are not saved when the Switch is rebooted. To save all your configuration changes in nonvolatile storage, you must use the save command to copy the running configuration file to the startup configuration.

## Assigning IP Addresses

Each Switch must be assigned its own IP Address, which is used for communication with an SNMP network manager or other TCP/IP application (for example BOOTP, TFTP). The Switch's default IP address is 10.90.90.90. You can change the default Switch IP address to meet the specification of your networking address scheme.

The Switch is also assigned a unique MAC address by the factory. This MAC address cannot be changed, and can be found by entering the command **show switch** into the command line interface, as shown below.



```

DGS-3620-28SC:admin#show switch
Command: show switch

Device Type           : DGS-3620-28SC Gigabit Ethernet Switch
Unit ID               : 1
MAC Address           : 14-D6-4D-AF-AA-00
IP Address            : 10.90.90.90 (Manual)
VLAN Name             : default
Subnet Mask           : 255.0.0.0
Default Gateway       : 0.0.0.0
Boot PROM Version     : Build 1.00.016
Firmware Version      : Build 2.60.016
Hardware Version      : B1
Firmware Type         : EI
Serial Number         : PVV01B5000008
System Name           :
System Location       :
System Uptime         : 0 days, 1 hours, 36 minutes, 17 seconds
System Contact        :
Spanning Tree         : Disabled
GVRP                  : Disabled
IGMP Snooping        : Disabled
MLD Snooping          : Disabled
RIP                   : Disabled
RIPng                 : Disabled
CTRL+C  ESC  q  Quit  SPACE  n  Next Page  ENTER  Next Entry  a  All

```

Figure 4-4 Show switch command

The Switch's MAC address can also be found from the Web management program on the **System Information window** in the Configuration folder.

The IP address for the Switch must be set before it can be managed with the Web-based manager. The Switch IP address can be automatically set using BOOTP or DHCP protocols, in which case the actual address assigned to the Switch must be known.

The IP address may be set using the Command Line Interface (CLI) over the console serial port as follows: Starting at the command line prompt, enter the commands

```
config ipif System ipaddress xxx.xxx.xxx.xxx/yyy.yyy.yyy.yyy
```

Where the x's represent the IP address to be assigned to the IP interface named System and the y's represent the corresponding subnet mask.

Alternatively, you can enter **config ipif System ipaddress xxx.xxx.xxx.xxx/z**. Where the x's represent the IP address to be assigned to the IP interface named System and the z represents the corresponding number of subnets in CIDR notation.

The IP interface named System on the Switch can be assigned an IP address and subnet mask, and then be used to connect a management station to the Switch's Telnet or Web-based management agent.

```

DGS-3620-28SC:admin# config ipif System ipaddress 10.90.90.91/255.0.0.0
Command: config ipif System ipaddress 10.90.90.91/8

Success.

DGS-3620-28SC:admin#

```

Figure 4–5 Assigning the Switch an IP Address

In the above example, the Switch was assigned an IP address of 10.90.90.91 with a subnet mask of 255.0.0.0 (the CIDR form was used to set the address (10.90.90.91/8)). The system message Success indicates that the command was executed successfully. The Switch can now be configured and managed via Telnet and the CLI or via the Web-based management.

## SNMP Settings

Simple Network Management Protocol (SNMP) is an OSI Layer 7 (Application Layer) designed specifically for managing and monitoring network devices. SNMP enables network management stations to read and modify the settings of gateways, routers, switches and other network devices. Use SNMP to configure system features for proper operation, monitor performance and detect potential problems in the Switch, switch group or network.

Managed devices that support SNMP include software (referred to as an agent), which runs locally on the device. A defined set of variables (managed objects) is maintained by the SNMP agent and used to manage the device. These objects are defined in a Management Information Base (MIB), which provides a standard presentation of the information controlled by the on-board SNMP agent. SNMP defines both the format of the MIB specifications and the protocol used to access this information over the network.

The Switch supports SNMP versions 1, 2c, and 3. The administrator may specify which SNMP version to use to monitor and control the Switch. The three SNMP versions vary in the level of security provided between the management station and the network device.

In SNMP v1 and v2, user authentication is accomplished using 'community strings', which function like passwords. The remote user SNMP application and the Switch SNMP must use the same community string. SNMP packets from any station that has not been authenticated are ignored (dropped).

The default community strings for the Switch used for SNMP v1 and v2 management access are:

- public - Allows authorized management stations to retrieve MIB objects.
- private - Allows authorized management stations to retrieve and modify MIB objects.

SNMP v3 uses a more sophisticated authentication process that is separated into two parts. The first part is to maintain a list of users and their attributes that are allowed to act as SNMP managers. The second part describes what each user on that list can do as an SNMP manager.

The Switch allows groups of users to be listed and configured with a shared set of privileges. The SNMP version may also be set for a listed group of SNMP managers. Thus, a group of SNMP managers can be created to view read-only information or receive traps using SNMP v1 while assigning a higher level of security to another group, granting read/write privileges using SNMP v3.

Using SNMP v3 individual users or groups of SNMP managers can be allowed to perform or be restricted from performing specific SNMP management functions. The functions allowed or restricted are defined using the Object Identifier (OID) associated with a specific MIB. An additional layer of security is available for SNMP v3 in that SNMP messages may be encrypted. To read more about how to configure SNMP v3 settings for the Switch read the section entitled Management.

## Traps

Traps are messages that alert network personnel of events that occur on the Switch. The events can be as serious as a reboot (someone accidentally turned OFF the Switch), or less serious like a port status change. The Switch generates traps and sends them to the trap recipient (or network manager). Typical traps include trap messages for Authentication Failure, Topology Change and Broadcast\Multicast Storm.

## Management Information Base (MIB)

The Switch in the Management Information Base (MIB) stores management and counter information. The Switch uses the standard MIB-II Management Information Base module. Consequently, values for MIB objects can be retrieved from any SNMP-based network management software. In addition to the standard MIB-II, the Switch also supports its own proprietary enterprise MIB as an extended Management Information Base. The proprietary MIB may also be retrieved by specifying the MIB Object Identifier. MIB values can be either read-only or read-write.

# Chapter 5 Web-based Switch Configuration

## Introduction

### Logging onto the Web Manager

#### Web-based User Interface

## Introduction

Most software functions of the Switch can be managed, configured, and monitored via the embedded Web-based (HTML) interface. Manage the Switch from remote stations anywhere on the network through a standard browser, such as Internet Explorer (version 5.5 and later), Netscape (version 8.0 and later), Mozilla Firefox (version 2.0 and later), or Safari (version 4.0 and later). The browser acts as a universal access tool and can communicate directly with the Switch using the HTTP protocol.

## Logging onto the Web Manager

To begin managing the Switch, simply run the browser installed on your computer and point it to the IP address you have defined for the device. The URL in the address bar should be in the format of `http://123.123.123.123`, where the numbers 123 represent the IP address of the Switch.



**NOTE:** The factory default IP address is 10.90.90.90 for normal ports. The factory default IP address is 192.168.0.1 is for the management port.

This opens the management module's user authentication window, as seen below. The following example is from 10.90.90.90.

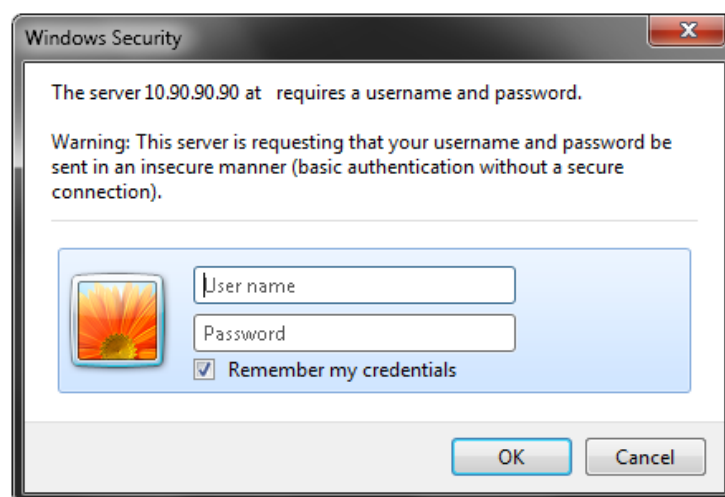

Figure 5–1 Enter Network Password Window

Leave the User Name field and the Password field blank and click **OK**. This will open the Web-based user interface. The Switch management features available in the web-based manager are explained below.

# Web-based User Interface

The user interface provides access to various Switch configuration and management windows, it allows the user to view performance statistics, and permits graphical monitoring of the system status.

## Areas of the User Interface

The figure below shows the user interface. Three distinct areas divide the user interface, as described in the table.

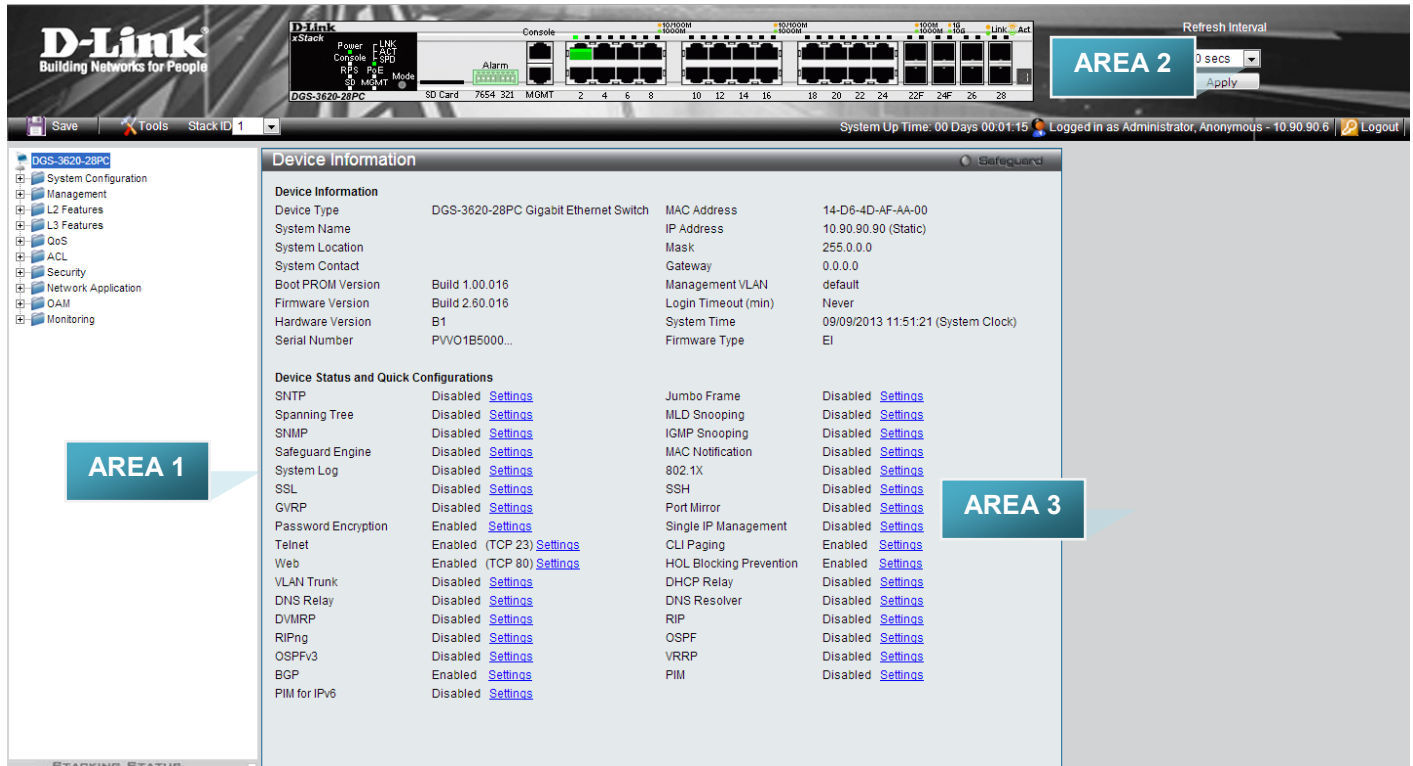

Figure 5–2 Main Web-manager Window

| Area          | Function   |
|---------------|--|
| <b>AREA 1</b> | Select the folder or window to display. Open folders and click the hyperlinked window buttons and subfolders contained within them to display windows.   |
| <b>AREA 2</b> | Presents a graphical near real-time image of the front panel of the Switch. This area displays the Switch's ports and expansion modules and shows port activity, depending on the specified mode. Some management functions, including port monitoring are accessible here. Click the D-Link logo to go to the D-Link Website. |
| <b>AREA 3</b> | Presents Switch status based on user selection and the entry of configuration data. In addition, hyperlinks are offered for many Switch features to enable quick configuration.  |

## Web Pages

When connecting to the management mode of the Switch with a Web browser, a login screen is displayed. Enter a user name and password to access the Switch's management mode.

Below is a list of the main folders available in the Web interface:

|                             |  |
|-----------------------------|--|
| <b>System Configuration</b> | In this section the user will be able to configure features regarding the Switch's configuration.                                    |
| <b>Management</b>           | In this section the user will be able to configure features regarding the Switch's management.                                       |
| <b>L2 Features</b>          | In this section the user will be able to configure features regarding the Layer 2 functionality of the Switch.                       |
| <b>L3 Features</b>          | In this section the user will be able to configure features regarding the Layer 3 functionality of the Switch.                       |
| <b>QoS</b>                  | In this section the user will be able to configure features regarding the Quality of Service functionality of the Switch.            |
| <b>ACL</b>                  | In this section the user will be able to configure features regarding the Access Control List functionality of the Switch.           |
| <b>Security</b>             | In this section the user will be able to configure features regarding the Switch's security.   |
| <b>Network Application</b>  | In this section the user will be able to configure features regarding network applications handled by the Switch.                    |
| <b>OAM</b>                  | In this section the user will be able to configure features regarding the Switch's operations, administration and maintenance (OAM). |
| <b>Monitoring</b>           | In this section the user will be able to monitor the Switch's configuration and statistics.  |

# Appendix A – Technical Specifications

## General

| Feature                     | Detailed Description  |
|-----------------------------|---|
| <b>Standards</b>            | IEEE 802.1ad Link Aggregation<br>IEEE 802.1Q Virtual LAN (VLAN)<br>IEEE 802.1X Port-based Network Access Control<br>IEEE 802.3az Energy-Efficient Ethernet (Hardware Version: B1)<br>IEEE 802.1D Spanning Tree Protocol |
| <b>Protocols</b>            | CSMA/CD   |
| <b>Data Transfer Rates:</b> | Half-duplex                      Full-duplex  |
| <b>Ethernet</b>             | 10 Mbps                              20Mbps   |
| <b>Fast Ethernet</b>        | 100Mbps                              200Mbps  |
| <b>Gigabit Ethernet</b>     | -----                              2Gbps  |
| <b>10 Gigabit Ethernet</b>  | -----                              20Gps  |
| <b>Stacking Topology</b>    | Duplex Ring, Duplex Chain   |
| <b>Network Cables</b>       | UTP/STP Category 5 Enhanced for 1000BASE-T<br>UTP/STP Category.5, 5 Enhanced for 100BASE-TX<br>UTP/STP Category 3, 4, 5 for 10BASE-T<br>EIA/TIA-568 100-ohm screened twisted-pair (STP) (100m)                          |

## Physical and Environmental

| Feature                                | Detailed Description  |
|--|---|
| <b>Internal Power Supply</b>           | <b>DGS-3620-28TC:</b> 100-240 VAC, 50/60 Hz<br><b>DGS-3620-28TC-DC:</b> -36 VDC ~ -72 VDC<br><b>DGS-3620-28SC:</b> 100-240 VAC, 50/60 Hz<br><b>DGS-3620-28SC-DC:</b> -36 VDC ~ -72 VDC<br><b>DGS-3620-28PC:</b> 100-240 VAC, 50/60 Hz<br><b>DGS-3620-52T:</b> 100-240 VAC, 50/60 Hz<br><b>DGS-3620-52P:</b> 100-240 VAC, 50/60 Hz   |
| <b>Optional Redundant Power Supply</b> | One connector in back to install optional external RPS. When internal power fails, the optional external RPS will take over all the power supply immediately and automatically. Supported<br><b>DGS-3620-28TC:</b> DPS-500 (Redundant Power Supply)<br><b>DGS-3620-28TC-DC:</b> None.<br><b>DGS-3620-28SC:</b> DPS-500 (Redundant Power Supply)<br><b>DGS-3620-28SC-DC:</b> None.<br><b>DGS-3620-28PC:</b> DPS-700 (Redundant Power Supply)<br><b>DGS-3620-52T:</b> DPS-500 (Redundant Power Supply)<br><b>DGS-3620-52P:</b> DPS-700 (Redundant Power Supply) |
| <b>Fans</b>                            | The IC Sensor detects the temperature on the switch automatically, and adjusts the speed.   |
| <b>Power Consumption</b>               | For hardware version A1, the following applies:<br><b>DGS-3620-28TC:</b> 50.8 Watt  |

|  |  |
|--|--|
|  | <p><b>DGS-3620-28TC-DC:</b> 51.5 Watt<br/> <b>DGS-3620-28SC:</b> 60.3 Watt<br/> <b>DGS-3620-28SC-DC:</b> 65.5 Watt<br/> <b>DGS-3620-28PC:</b> 478.0 Watt with 350 Watt PoE load<br/> <b>DGS-3620-52T:</b> 81.0 Watt<br/> <b>DGS-3620-52P:</b> 505.4 Watt with 350 Watt PoE load</p> <p>For hardware version B1, the following applies:<br/> <b>DGS-3620-28TC:</b> 45.1 Watt (Max.)<br/> <b>DGS-3620-28TC-DC:</b> 47.4 Watt (Max.)<br/> <b>DGS-3620-28SC:</b> 43.4 Watt (Max.)<br/> <b>DGS-3620-28SC-DC:</b> 44.6 Watt (Max.)<br/> <b>DGS-3620-28PC:</b> 502.2 Watt (Max.) with 370 Watt PoE load<br/> <b>DGS-3620-52T:</b> 76.0 Watt (Max.)<br/> <b>DGS-3620-52P:</b> 517.1 Watt (Max.) with 370 Watt PoE load</p> |
| <b>Temperature</b>                               | <p><b>Operating:</b> 0°C ~ 50°C<br/> <b>Storage:</b> -40°C ~ 70°C</p>  |
| <b>Humidity</b>                                  | <p><b>Operating:</b> 10% ~ 90% (non-condensing)<br/> <b>Storage:</b> 5% ~ 90% (non-condensing)</p>   |
| <b>Dimensions</b>                                | <p><b>DGS-3620-28TC:</b> 441mm (W) x 310mm (D) x 44mm (H)<br/> <b>DGS-3620-28TC-DC:</b> 441mm (W) x 310mm (D) x 44mm (H)<br/> <b>DGS-3620-28SC:</b> 441mm (W) x 310mm (D) x 44mm (H)<br/> <b>DGS-3620-28SC-DC:</b> 441mm (W) x 310mm (D) x 44mm (H)<br/> <b>DGS-3620-28PC:</b> 441mm (W) x 380mm (D) x 44mm (H)<br/> <b>DGS-3620-52T:</b> 441mm (W) x 380mm (D) x 44mm (H)<br/> <b>DGS-3620-52P:</b> 441mm (W) x 380mm (D) x 44mm (H)</p>  |
| <b>Weight</b>                                    | <p><b>DGS-3620-28TC:</b> 4.15 kg<br/> <b>DGS-3620-28TC-DC:</b> 4.15 kg<br/> <b>DGS-3620-28SC:</b> 4.10 kg<br/> <b>DGS-3620-28SC-DC:</b> 4.10 kg<br/> <b>DGS-3620-28PC:</b> 5.76 kg<br/> <b>DGS-3620-52TC:</b> 5.13 kg<br/> <b>DGS-3620-52P:</b> 6.30 kg</p>  |
| <b>MTBF</b>                                      | <p><b>DGS-3620-28TC:</b> 287763.2892 Hours<br/> <b>DGS-3620-28TC-DC:</b> 372899.3973 Hours<br/> <b>DGS-3620-28SC:</b> 299801.4971 Hours<br/> <b>DGS-3620-28SC-DC:</b> 393367.7595 Hours<br/> <b>DGS-3620-28PC:</b> 230619.6475 Hours<br/> <b>DGS-3620-52T:</b> 255608.808 Hours<br/> <b>DGS-3620-52P:</b> 202462.1368 Hours</p>  |
| <b>EMI/EMC; RF Certificates and Test Reports</b> | CE Class A, FCC Class A, VCCI Report Class A, C-Tick Report Class A, BSMI  |
| <b>Safety Certifications and Test Reports</b>    | UL/CSA 60950-1, IEC 60950-1:2001, BSMI   |

## Performance

### Feature

### Detailed Description



|  |  |
|--|--|
| <b>Transmission Method</b>                   | Store-and-forward.   |
| <b>Packet Buffer</b>                         | 2 MBytes per device.   |
| <b>Packet Filtering / Forwarding Rate</b>    | Full-wire speed for all connections.<br>1,488,095 pps per port (for 1000Mbps).<br>148,810 pps per port (100Mbps).  |
| <b>Wire speed</b>                            | Wire speed operation on all FE/GE ports.   |
| <b>Switching Capacity</b>                    | <b>DGS-3620-28TC:</b> 128 Gbps<br><b>DGS-3620-28TC-DC:</b> 128 Gbps<br><b>DGS-3620-28SC:</b> 128 Gbps<br><b>DGS-3620-28SC-DC:</b> 128 Gbps<br><b>DGS-3620-28PC:</b> 128 Gbps<br><b>DGS-3620-52T:</b> 176 Gbps<br><b>DGS-3620-52P:</b> 176 Gbps   |
| <b>64 Byte System Packet Forwarding Rate</b> | <b>DGS-3620-28TC:</b> 95.24 Mpps (Mega Packets Per Second)<br><b>DGS-3620-28TC-DC:</b> 95.24 Mpps (Mega Packets Per Second)<br><b>DGS-3620-28SC:</b> 95.24 Mpps (Mega Packets Per Second)<br><b>DGS-3620-28SC-DC:</b> 95.24 Mpps (Mega Packets Per Second)<br><b>DGS-3620-28PC:</b> 95.24 Mpps (Mega Packets Per Second)<br><b>DGS-3620-52T:</b> 130.95 Mpps (Mega Packets Per Second)<br><b>DGS-3620-52P:</b> 130.95 Mpps (Mega Packets Per Second) |
| <b>Priority Queues</b>                       | 8 Priority Queues per port.  |
| <b>MAC Address Table</b>                     | Supports 32K MAC addresses.<br>Supports 256 Static MAC addresses.  |
| <b>Virtual Stacking / Clustering</b>         | Supports D-Link Single IP Management version 1.6.<br>Manage up to 32 devices in a virtual stack with a single IP address.  |

## LED Indicators

| Location   | LED Indicative | Color        | Status      | Description                   |
|------------|----------------|--------------|-------------|-------------------------------|
| Per Device | Power          | Green        | Solid Light | Power on                      |
|            |                |              | Light off   | Power off                     |
|            | Console        | Green        | Solid Light | Console on                    |
|            |                |              | Light off   | Console off                   |
|            |                |              | RPS         | Green                         |
|            | Solid Light    | RPS in using |             |                               |
|            | Light off      | RPS off      |             |                               |
|            | SD             | Green        | Solid Light | Plugged in                    |
|            |                |              | Blinking    | Busy Reading and Writing      |
|            |                |              | Light off   | No link                       |
|            |                |              | Red         | Solid Light                   |
|            | MGMT           | Green        | Solid Light | Console on                    |
|            |                |              | Blinking    | Secure connection established |
|            |                |              | Light off   | Console off                   |

|                                      |                                |   |                         |  |
|--------------------------------------|--------------------------------|---|-------------------------|--|
|                                      | <b>Stacking ID</b>             | Green   | Capable 1 – 12, H, h, G | <p>The box ID is assigned either by user (static mode) or by the system (automatic mode). When the box become a primary master, the 7 segment works as bi-function. That is box ID and “H” indicate as primary Master and the display will be shown by turn. That is boxID -&gt; H -&gt; boxID -&gt; H</p> <p>1-12: To indicate the stacking of the switch</p> <p>H: When device was assigned as the stacking Master</p> <p>h: When device was selected to be the Backup Master</p> <p>G: When Safeguard Engine entering the exhausted mode.</p> |
|                                      | <b>Port LED Mode Indicator</b> | <p>A LED Mode Select Button to switch two modes in turn for all 10/100/1000Mbps ports on DGS-3620-28PC/52P:</p> <ul style="list-style-type: none"> <li>• Link/Act/Speed Mode</li> <li>• PoE Mode</li> </ul> |                         |  |
|                                      |                                | Green   | Solid Light             | A LED Mode Select Button to switch Link/Act/Speed Mode   |
|                                      |                                |   | Solid Light             | A LED Mode Select Button to switch PoE Mode  |
| <b>LED Per 10/100/1000 Mbps Port</b> | <b>Link/Act/Speed Mode</b>     | Green   | Solid Light             | When there is a secure connection (or link) to 1000Mbps Ethernet device at any of the ports.   |
|                                      |                                |   | Blinking                | When there is reception or transmission of data occurring at 1000Mbps.   |
|                                      |                                | Orange  | Solid Light             | When there is a secure connection (or link) to 10/100Mbps Ethernet device at any of the ports.   |
|                                      |                                |   | Blinking                | When there is reception or transmission of data occurring at 10/100Mbps.   |
|                                      | Off                            | Light off   | No link.                |  |
|                                      | <b>PoE Mode</b>                | Green   | Solid Light             | Power feeding.   |
|                                      |                                | Orange  | Solid Light             | Error Condition.   |
| Off                                  |                                | Light Off   | No Power feeding.       |  |
| <b>LED per SFP Port</b>              | <b>Link/Act</b>                | Green   | Solid Light             | When there is a secure connection (or link) to 1000Mbps Ethernet device at any of the ports.   |
|                                      |                                |   | Blinking                | When there is reception or transmission of data occurring at 1000Mbps.   |
|                                      |                                | Orange  | Solid Light             | When there is a secure connection (or link) to 100Mbps Ethernet device at any of the ports.  |
|                                      |                                |   | Blinking                | When there is reception or transmission of data occurring at 100Mbps.  |

|                          |                 |        |             |  |
|--------------------------|-----------------|--------|-------------|--|
|                          |                 | Off    | Light off   | No link  |
| <b>LED per SFP+ Port</b> | <b>Link/Act</b> | Green  | Solid Light | When there is a secure connection (or link) to 10G bps Ethernet device at any of the ports.        |
|                          |                 |        | Blinking    | When there is reception or transmission (i.e. Activity--Act) of data occurring at a 10G bps port.  |
|                          |                 | Orange | Solid Light | When there is a secure connection (or link) to 1000Mbps Ethernet device at any of the ports.       |
|                          |                 |        | Blinking    | When there is reception or transmission (i.e. Activity--Act) of data occurring at a 1000Mbps port. |
|                          |                 | Off    | Light off   | Link down  |

## Port Functions

| Feature             | Detailed Description  |
|---------------------|---|
| <b>Console Port</b> | RJ-45 interface for Out-Of-Band (OOB) CLI configuration.  |
| <b>Copper Ports</b> | <p><b>Compliant with the following standards:</b></p> <ul style="list-style-type: none"> <li>• IEEE 802.3 compliance</li> <li>• IEEE 802.3u compliance</li> <li>• IEEE 802.3az compliance (100/1000Mbps) (Hardware Version: B1)</li> <li>• Support Full-Duplex operations</li> <li>• IEEE 802.3x Flow Control support for Full-Duplex mode</li> <li>• IEEE 802.3ab compliance</li> <li>• IEEE 802.3af compliance (DGS-3620-28PC &amp; DGS-3620-52P only)</li> <li>• IEEE 802.3at compliance (DGS-3620-28PC &amp; DGS-3620-52P only)</li> </ul>  |
| <b>SFP Ports</b>    | <p><b>Compliant with the following standards:</b></p> <ul style="list-style-type: none"> <li>• IEEE 802.3z compliance</li> <li>• IEEE 802.3u compliance</li> </ul> <p><b>SFP Transceivers Supported:</b></p> <ul style="list-style-type: none"> <li>• DEM-310GT (1000BASE-LX, Single-mode, 10km)</li> <li>• DEM-311GT (1000BASE-SX, Mutli-mode, 550m)</li> <li>• DEM-312GT2 (1000BASE-SX, Multi-mode, 2km)</li> <li>• DEM-314GT (1000BASE-LHX, Single-mode, 50km)</li> <li>• DEM-315GT (1000BASE-ZX, Single-mode, 80km)</li> <li>• DEM-210 (100BASE-FX, Single-mode, 15km)</li> <li>• DEM-211 (100BASE-FX, Multi-mode, 2km)</li> <li>• DEM-220T (100BASE-BX, Wavelength Tx:1550nm, Rx:1310nm, Single-mode, 20km)</li> <li>• DEM-220R (100BASE-BX, Wavelength Tx:1310nm, Rx:1550nm, Single-mode, 20km)</li> <li>• DGS-712 (1000BASE-TX)</li> </ul> <p><b>WDM Transceivers Supported:</b></p> <ul style="list-style-type: none"> <li>• DEM-330T/R (1000BASE-BX, Single-Mode, 10km)</li> </ul> |

|                   | <ul style="list-style-type: none"> <li>• DEM-331T/R (1000BASE-BX, Single-Mode, 40km)</li> </ul>   |                      |  |       |       |                      |   |         |            |
|-------------------|---|----------------------|--|-------|-------|----------------------|---|---------|------------|
| <b>SFP+ Ports</b> | <p><b>Compliant with the following standards:</b></p> <ul style="list-style-type: none"> <li>• IEEE 802.3ae compliance</li> <li>• IEEE 802.3aq compliance</li> <li>• IEEE 802.3z compliance</li> </ul> <p><b>SFP Transceivers Supported:</b></p> <ul style="list-style-type: none"> <li>• DEM-310GT (1000BASE-LX, Single-mode, 10km)</li> <li>• DEM-311GT (1000BASE-SX, Mutli-mode, 550m)</li> <li>• DEM-312GT2 (1000BASE-SX, Multi-mode, 2km)</li> <li>• DEM-314GT (1000BASE-LHX, Single-mode, 50km)</li> <li>• DEM-315GT (1000BASE-ZX, Single-mode, 80km)</li> <li>• DEM-330T/R (1000BASE-BX, WDM transceiver, Single-Mode 10km)</li> <li>• DEM-331T/R (1000BASE-BX, WDM transceiver, Single-Mode 40km)</li> </ul> <p><b>SFP+ Transceivers Supported:</b></p> <ul style="list-style-type: none"> <li>• DEM-431XT-DD (10GBASE-SR SFP+ Transceiver, 80m: OM1 &amp; OM2 MMF 300m: OM3 MMF)</li> <li>• DEM-431XT (10GBASE-SR SFP+ Transceiver (w/o DDM), 80m: OM1 &amp; OM2 MMF 300m: OM3 MMF)</li> <li>• DEM-432XT-DD (10GBASE-LR SFP+ Transceiver, 10km)</li> <li>• DEM-432XT (10GBASE-LR SFP+ Transceiver (w/o DDM), 10km)</li> <li>• DEM-433XT-DD (10GBASE-ER SFP+ Transceiver, 40km)</li> <li>• DEM-433XT (10GBASE-ER SFP+ Transceiver (w/o DDM), 40km)</li> <li>• DEM-435XT-DD (10GBASE-LRM SFP+ Transceiver, 220m: OM1 &amp; OM2 MMF, 300m: OM3 MMF)</li> <li>• DEM-435XT (10GBASE-LRM SFP+ Transceiver (w/o DDM), 220m: OM1 &amp; OM2 MMF, 300m: OM3 MMF)</li> <li>• DEM-436XT-BXU (10GBASE-LR BiDi SFP+ Transceiver (w/o DDM), 20km, TX: 1270nm, RX: 1330nm)</li> <li>• DEM-436XT-BXD (10GBASE-LR BiDi SFP+ Transceiver (w/o DDM), 20km, TX: 1330nm, RX: 1270nm)</li> </ul> <p><b>SFP+ Direct Attached Cables (DAC) Supported:</b></p> <ul style="list-style-type: none"> <li>• DEM-CB100S-10-GbE (SFP+, 1m, Direct Attach Cable)</li> <li>• DEM-CB300S-10-GbE (SFP+, 3m Direct Attach Cable)</li> <li>• DEM-CB700S-10-GbE (SFP+, 7m Direct Attach Cable)</li> </ul> |                      |  |       |       |                      |   |         |            |
| <b>PoE Ports</b>  | <ol style="list-style-type: none"> <li>1. Supports IEEE 802.3af PoE and IEEE 802.3at PoE+ compliance.</li> <li>2. Supplies power to PD devices up to 15.4 Watt per port (802.3af) or 30 Watt per port (802.3at) and more sufficiently is able to provide power to PD devices.</li> <li>3. Power Consumption: 370 Watt, but when connected to the RPS the consumption is 740 Watt.</li> <li>4. The auto-discovery feature automatically recognizes the connection of the PD device and immediately provides power.</li> <li>5. Autotomatically disable ports if the port current is over 600mA while. Other ports will remain active.</li> <li>6. Active circuit protection automatically disables the port if there is a short while other ports remain active.</li> <li>7. For 802.3af/at capable devices it will provide the power for the following classifications below:</li> </ol> <table border="1" data-bbox="432 2027 1508 2121"> <thead> <tr> <th data-bbox="432 2027 667 2078">Class</th> <th data-bbox="667 2027 1015 2078">Usage</th> <th data-bbox="1015 2027 1508 2078">Max Power used by PD</th> </tr> </thead> <tbody> <tr> <td data-bbox="432 2078 667 2121">0</td> <td data-bbox="667 2078 1015 2121">Default</td> <td data-bbox="1015 2078 1508 2121">12.95 Watt</td> </tr> </tbody> </table>   |                      |  | Class | Usage | Max Power used by PD | 0 | Default | 12.95 Watt |
| Class             | Usage   | Max Power used by PD |  |       |       |                      |   |         |            |
| 0                 | Default   | 12.95 Watt           |  |       |       |                      |   |         |            |

|  |   |          |            |
|--|---|----------|------------|
|  | 1 | Optional | 3.84 Watt  |
|  | 2 | Optional | 6.49 Watt  |
|  | 3 | Optional | 12.95 Watt |
|  | 4 | Reserved | 29.5 Watt  |

8. Follow the PSE pin out standard. For an alternative solution, send the power over pins 1, 2, 3, 6 and 8 wires. Use Category 3, 6A UTP cable for 802.3af or Category 5e, 6A UTP cable for 802.3at.

9. DGS-3620-28PC and DGS-3620-52P works with all D-Link 802.3af and 802.3at capable devices and with all non-802.3af and non-802.3at capable D-Link Access Points, IP Cameras and IP Phones.

# Appendix B – Cables and Connectors

## Ethernet Cable

When connecting the Switch to another switch, a bridge or hub, a normal cable is necessary. Please review these products for matching cable pin assignment. The following diagrams and tables show the standard RJ-45 connector and their pin assignments.

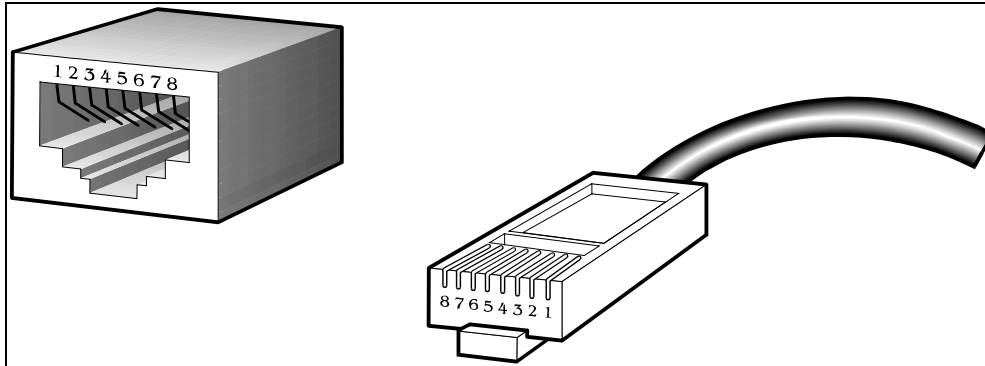

Figure B-1 Standard RJ-45 port and connector

| RJ-45 Pin Assignments |                |                |
|-----------------------|----------------|----------------|
| Pin                   | MDI-X Port     | MDI-II Port    |
| 1                     | RD+ (receive)  | TD+ (transmit) |
| 2                     | RD- (receive)  | TD- (transmit) |
| 3                     | TD+ (transmit) | RD+ (receive)  |
| 4                     | 1000BASE-T     | 1000BASE-T     |
| 5                     | 1000BASE-T     | 1000BASE-T     |
| 6                     | TD- (transmit) | RD- (receive)  |
| 7                     | 1000BASE-T     | 1000BASE-T     |
| 8                     | 1000BASE-T     | 1000BASE-T     |

## Console Cable

When connecting the Switch to a PC, a Console cable is necessary. The following diagrams and tables show the standard Console-to-DJ-45 receptacle/connector and their pin assignments.

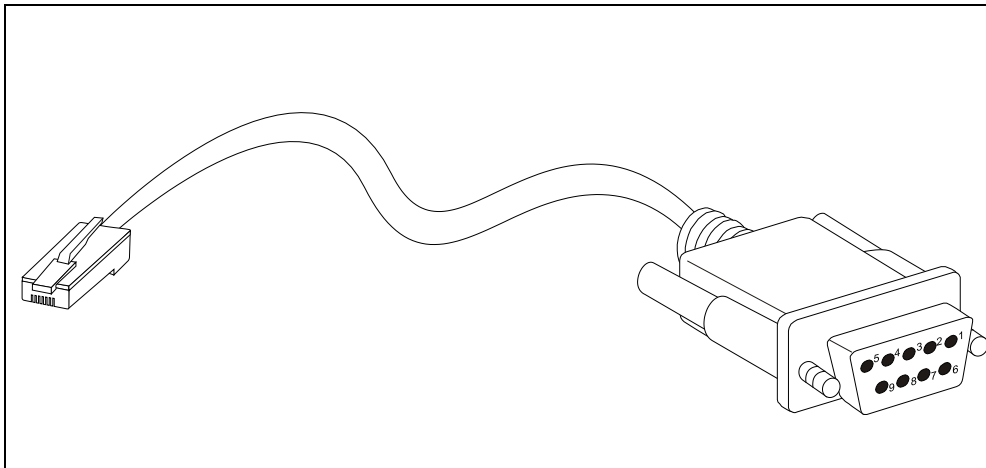

Figure B-2 Console-to-RJ-45 Cable

| Console-RJ-45 Pin Assignments |                     |          |
|-------------------------------|---------------------|----------|
| Pin                           | Console (DB9/RS232) | RJ-45    |
| 1                             | Not Used            | Not Used |
| 2                             | RXD                 | Not Used |
| 3                             | TXD                 | TXD      |
| 4                             | Not Used            | GND      |
| 5                             | GND (shared)        | GND      |
| 6                             | Not Used            | RXD      |
| 7                             | Not Used            | Not Used |
| 8                             | Not Used            | Not Used |

## Redundant Power Supply (RPS) Cable

When connecting the Switch to a Redundant Power Supply, an RPS cable is necessary. Please review these products for matching cable pins. The following diagrams and tables show the standard RPS connector and their pin assignments.



**NOTE:** The DGS-3620-28PC and the DGS-3620-52P use the RPS-700 and not the RPS-500. Both devices have their own cables included in the package.

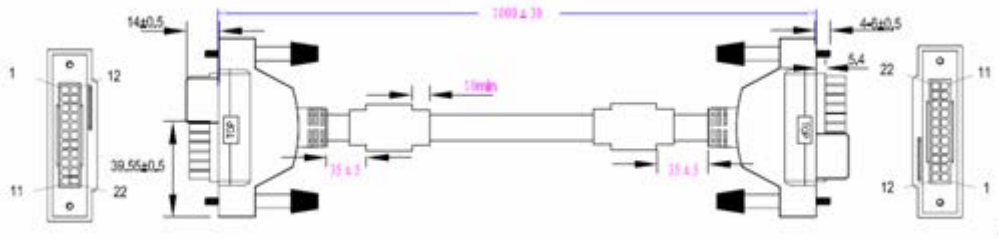

Figure B-3 Redundant Power Supply (RPS) Cable – DPS-500/DPS-700

| RPS Cable Pin Assignments |               |               |
|---------------------------|---------------|---------------|
| Pin                       | Device        | DPS-500       |
| 1                         | GND           | GND           |
| 2                         | NC            | NC            |
| 3                         | +12V          | +12V          |
| 4                         | +12V          | +12V          |
| 5                         | +12V          | +12V          |
| 6                         | +12V          | +12V          |
| 7                         | GND           | GND           |
| 8                         | GND           | GND           |
| 9                         | NC            | Power Good    |
| 10                        | NC            | Power Present |
| 11                        | Power Good    | NC            |
| 12                        | Power Present | NC            |
| 13                        | GND           | GND           |
| 14                        | GND           | GND           |

| RPS Cable Pin Assignments |         |         |
|---------------------------|---------|---------|
| Pin                       | Device  | DPS-700 |
| 1                         | -54Vrtn | -54Vrtn |
| 2                         | -54V    | -54V    |
| 3                         | +12V    | +12V    |
| 4                         | +12V    | +12V    |
| 5                         | +12V    | +12V    |
| 6                         | +12V    | +12V    |
| 7                         | NC/GND  | NC/GND  |



|    |             |             |
|----|-------------|-------------|
| 8  | +12vsen     | +12Ven      |
| 9  | LS-54v      | LS-54V      |
| 10 | -54V        | -54V        |
| 11 | -54Vrtn     | -54Vrtn     |
| 12 | GND         | GND         |
| 13 | GND/NC      | GND/NC      |
| 14 | RPS Present | RPS Present |
| 15 | Status_1    | RPS PG      |
| 16 | Status_2    | GND         |
| 17 | RPS PG      | Status_1    |
| 18 | GND         | Status_2    |
| 19 | +12VRTNsen  | +12VRTNsen  |
| 20 | LS+12V      | LS+12V      |
| 21 | -54Vsen     | -54Vsen     |

Subject to the terms and conditions set forth herein, D-Link Systems, Inc. ("D-Link") provides this lifetime product warranty for hardware:

- Only for products purchased, delivered and used within the fifty states of the United States, the District of Columbia, U.S. Possessions or Protectorates, U.S. Military Installations, or addresses with an APO or FPO, and;
- Only with proof of purchase.

**Product Warranty:** D-Link warrants that the hardware portion of the D-Link product, including internal and external power supplies and fans ("Hardware"), will be free from material defects in workmanship and materials under normal use from the date of original retail purchase of the product ("Warranty Period"), except as otherwise stated herein.

The customer's sole and exclusive remedy and the entire liability of D-Link and its suppliers under this Warranty will be, at D-Link's option, to repair or replace the defective Hardware during the Warranty Period at no charge to the owner or to refund the actual purchase price paid. Any repair or replacement will be rendered by D-Link at an Authorized D-Link Service Office. The replacement hardware need not be new or have an identical make, model or part. D-Link may, at its option, replace the defective Hardware or any part thereof with any reconditioned product that D-Link reasonably determines is substantially equivalent (or superior) in all material respects to the defective Hardware. Repaired or replacement hardware will be warranted for the remainder of the original Warranty Period or ninety (90) days, whichever is longer, and is subject to the same limitations and exclusions. If a material defect is incapable of correction, or if D-Link determines that it is not practical to repair or replace the defective Hardware, the actual price paid by the original purchaser for the defective Hardware will be refunded by D-Link upon return to D-Link of the defective Hardware. All Hardware or part thereof that is replaced by D-Link, or for which the purchase price is refunded, shall become the property of D-Link upon replacement or refund.

**Software Warranty:** D-Link warrants that the software portion of the product ("Software") will substantially conform to D-Link's then current functional specifications for the Software, as set forth in the applicable documentation, from the date of original retail purchase of the Software for a period of ninety (90) days ("Software Warranty Period"), provided that the Software is properly installed on approved hardware and operated as contemplated in its documentation. D-Link further warrants that, during the Software Warranty Period, the magnetic media on which D-Link delivers the Software will be free of physical defects. The customer's sole and exclusive remedy and the entire liability of D-Link and its suppliers under this Limited Warranty will be, at D-Link's option, to replace the non-conforming Software (or defective media) with software that substantially conforms to D-Link's functional specifications for the Software or to refund the portion of the actual purchase price paid that is attributable to the Software. Except as otherwise agreed by D-Link in writing, the replacement Software is provided only to the original licensee, and is subject to the terms and conditions of the license granted by D-Link for the Software. Replacement Software will be warranted for the remainder of the original Warranty Period and is subject to the same limitations and exclusions. If a material non-conformance is incapable of correction, or if D-Link determines in its sole discretion that it is not practical to replace the non-conforming Software, the price paid by the original licensee for the non-conforming Software will be refunded by D-Link; provided that the non-conforming Software (and all copies thereof) is first returned to D-Link. The license granted respecting any Software for which a refund is given automatically terminates.

**Non-Applicability of Warranty:** The Warranty provided hereunder for D-Link's products will not be applied to and does not cover any products obtained through a special or unique pricing agreement, if such agreement provides for warranty terms different from those normally provided with the product or set forth herein, nor to any refurbished product and any product purchased through the inventory clearance or liquidation sale or other sales in which D-Link, the sellers, or the liquidators expressly disclaim their warranty obligation pertaining to the product and in that case, the product is being sold "As-Is" without any warranty whatsoever including, without limitation, the Warranty as described herein, notwithstanding anything stated herein to the contrary.

**Submitting A Claim:** The customer shall return the product to the original purchase point based on its return policy. In case the return policy period has expired and the product is within warranty, the customer shall submit a claim to D-Link as outlined below:

- The customer must submit with the product as part of the claim a written description of the Hardware defect or Software nonconformance in sufficient detail to allow D-Link to confirm the same, along with proof of purchase of the product (such as a copy of the dated purchase invoice for the product).
- The customer must obtain a Case ID Number from D-Link Technical Support by going to <https://support.dlink.com>, who will attempt to assist the customer in resolving any suspected defects with the product. If the product is considered defective, the customer must obtain a Return Material Authorization ("RMA") number by completing the RMA form and entering the assigned Case ID Number at <https://rma.dlink.com/>.
- After an RMA number is issued, the defective product must be packaged securely in the original or other suitable shipping package to ensure that it will not be damaged in transit, and the RMA number must be prominently marked on the outside of the package. Include any manuals or accessories in the shipping package.
- The customer is responsible for all in-bound shipping charges to D-Link. No Cash on Delivery ("COD") is allowed. Products sent COD will either be rejected by D-Link or become the property of D-Link. Products shall be fully insured by the customer and shipped to **D-Link Systems, Inc., 17595 Mt. Herrmann, Fountain Valley, CA 92708**. D-Link will not be held responsible for any packages that are lost in transit to D-Link. The repaired or replaced packages will be shipped to the customer via UPS Ground or any common carrier selected by D-Link. Return shipping charges shall be prepaid by D-Link if you use an address in the United States, otherwise we will ship the product to you freight collect. Expedited shipping is available upon request and provided shipping charges are prepaid by the customer.

D-Link may reject or return any product that is not packaged and shipped in strict compliance with the foregoing requirements, or for which an RMA number is not visible from the outside of the package. The product owner agrees to pay D-Link's reasonable handling and return shipping charges for any product that is not packaged and shipped in accordance with the foregoing requirements, or that is determined by D-Link not to be defective or non-conforming.

**What Is Not Covered:** The Warranty provided herein by D-Link does not cover: Products that, in D-Link's judgment, have been subjected to abuse, accident, alteration, modification, tampering, negligence, misuse, faulty installation, lack of reasonable care, repair or service in any way that is not contemplated in the documentation for the product, or if the model or serial number has been altered, tampered with, defaced or removed; Initial installation, installation and removal of the product for repair, and shipping costs; Operational adjustments covered in the operating manual for the product, and normal maintenance; Damage that occurs in shipment, due to act of God, failures due to power surge, and cosmetic damage; Any hardware, software, firmware or other products or services provided by anyone other than D-Link; and Products that have been purchased from inventory clearance or liquidation sales or other sales in which D-Link, the sellers, or the liquidators expressly disclaim their warranty obligation pertaining to the product. While necessary maintenance or repairs on your Product can be performed by any company, we recommend that you use only an Authorized D-Link Service Office. Improper or incorrectly performed maintenance or repair voids this Warranty.

**Disclaimer of Other Warranties:** EXCEPT AS SPECIFICALLY SET FORTH ABOVE OR AS REQUIRED BY LAW, THE PRODUCT IS PROVIDED "AS-IS" WITHOUT ANY WARRANTY OF ANY KIND WHATSOEVER INCLUDING, WITHOUT LIMITATION, ANY WARRANTY OF MERCHANTABILITY, FITNESS FOR A PARTICULAR PURPOSE AND NON-INFRINGEMENT. IF ANY IMPLIED WARRANTY CANNOT BE DISCLAIMED IN ANY TERRITORY WHERE A PRODUCT IS SOLD, THE DURATION OF SUCH IMPLIED WARRANTY SHALL BE LIMITED TO NINETY (90) DAYS. EXCEPT AS EXPRESSLY COVERED UNDER THE WARRANTY PROVIDED HEREIN, THE ENTIRE RISK AS TO THE QUALITY, SELECTION AND PERFORMANCE OF THE PRODUCT IS WITH THE PURCHASER OF THE PRODUCT.

**Limitation of Liability:** TO THE MAXIMUM EXTENT PERMITTED BY LAW, D-LINK IS NOT LIABLE UNDER ANY CONTRACT, NEGLIGENCE, STRICT LIABILITY OR OTHER LEGAL OR EQUITABLE THEORY FOR ANY LOSS OF USE OF THE PRODUCT, INCONVENIENCE OR DAMAGES OF ANY CHARACTER, WHETHER DIRECT, SPECIAL, INCIDENTAL OR CONSEQUENTIAL (INCLUDING, BUT NOT LIMITED TO, DAMAGES FOR LOSS OF GOODWILL, LOSS OF REVENUE OR PROFIT, WORK STOPPAGE, COMPUTER FAILURE OR MALFUNCTION, FAILURE OF OTHER EQUIPMENT OR COMPUTER PROGRAMS TO WHICH D-LINK'S PRODUCT IS CONNECTED WITH, LOSS OF INFORMATION OR DATA CONTAINED IN, STORED ON, OR INTEGRATED WITH ANY PRODUCT RETURNED TO D-LINK FOR WARRANTY SERVICE) RESULTING FROM THE USE OF THE PRODUCT, RELATING TO WARRANTY SERVICE, OR ARISING OUT OF ANY BREACH OF THIS WARRANTY, EVEN IF D-LINK HAS BEEN ADVISED OF THE POSSIBILITY OF SUCH DAMAGES. THE SOLE REMEDY FOR A BREACH OF THE FOREGOING WARRANTY IS REPAIR, REPLACEMENT OR REFUND OF THE DEFECTIVE OR NON-CONFORMING PRODUCT. THE MAXIMUM LIABILITY OF D-LINK UNDER THIS WARRANTY IS LIMITED TO THE PURCHASE PRICE OF THE PRODUCT COVERED BY THE WARRANTY. THE FOREGOING EXPRESS WRITTEN WARRANTIES AND REMEDIES ARE EXCLUSIVE AND ARE IN LIEU OF ANY OTHER WARRANTIES OR REMEDIES, EXPRESS, IMPLIED OR STATUTORY.

**Lifetime Warranty:** IF LOCAL LAW MANDATES THE USE OF A DEFINITION OF "LIFETIME WARRANTY" DIFFERENT FROM THAT PROVIDED HEREIN, THEN THE LOCAL LAW DEFINITION WILL SUPERSEDE AND TAKE PRECEDENCE, TO THE EXTENT NECESSARY TO COMPLY.

**Governing Law:** This Warranty shall be governed by the laws of the State of California. Some states do not allow exclusion or limitation of incidental or consequential damages, or limitations on how long an implied warranty lasts, so the foregoing limitations and exclusions may not apply. This Warranty provides specific legal rights and you may also have other rights which vary from state to state.

**Trademarks:** D-Link is a registered trademark of D-Link Systems, Inc. Other trademarks or registered trademarks are the property of their respective owners.

**Copyright Statement:** No part of this publication or documentation accompanying this product may be reproduced in any form or by any means or used to make any derivative such as translation, transformation, or adaptation without permission from D-Link Corporation/D-Link Systems, Inc., as stipulated by the United States Copyright Act of 1976 and any amendments thereto. Contents are subject to change without prior notice. Copyright 2009 by D-Link Corporation/D-Link Systems, Inc. All rights reserved.

**CE Mark Warning:** This is a Class A product. In a residential environment, this product may cause radio interference, in which case the user may be required to take adequate measures.

**FCC Statement:** This equipment has been tested and found to comply with the limits for a Class A digital device, pursuant to part 15 of the FCC Rules. These limits are designed to provide reasonable protection against harmful interference in a commercial installation. This equipment generates, uses, and can radiate radio frequency energy and, if not installed and used in accordance with the instructions, may cause harmful interference to radio communication. However, there is no guarantee that interference will not occur in a particular installation. Operation of this equipment in a residential environment is likely to cause harmful interference to radio or television reception. If this equipment does cause harmful interference to radio or television reception, which can be determined by turning the equipment off and on, the user is encouraged to try to correct the interference by one or more of the following measures:

- Reorient or relocate the receiving antenna.
- Increase the separation between the equipment and receiver.
- Connect the equipment into an outlet on a circuit different from that to which the receiver is connected.
- Consult the dealer or an experienced radio/TV technician for help.

**For detailed warranty information applicable to products purchased outside the United States, please contact the corresponding local D-Link office.**

## *Product Registration*

*Register your D-Link product online at <http://support.dlink.com/register/>  
Product registration is entirely voluntary and failure to complete or return this form will not diminish your warranty rights.*

# Tech Support

## Technical Support

You can find software updates and user documentation on the D-Link website.

D-Link provides free technical support for customers within the United States and within Canada for the duration of the service period, and warranty confirmation service, during the warranty period on this product. U.S. and Canadian customers can contact D-Link technical support through our website, or by phone.

### Tech Support for customers within the United States:

***D-Link Technical Support over the Telephone:***

USA - 877-DLINK-55 (877-354-6555)

***D-Link Technical Support over the Internet:***

<http://support.dlink.com>

### Tech Support for customers within Canada:

***D-Link Technical Support over the Telephone:***

877-354-6560

***D-Link Technical Support over the Internet:***

<http://support.dlink.com>

**D-Link<sup>®</sup>**  
Building Networks for People

## Technical Support

### United Kingdom (Mon-Fri)

Home Wireless/Broadband 0871 873 3000 (9.00am–06.00pm, Sat 10.00am-02.00pm)  
Managed, Smart, & Wireless Switches, or Firewalls 0871 873 0909 (09.00am – 05.30pm)  
(BT 10ppm, other carriers may vary.)

### Ireland (Mon-Fri)

All Products 1890 886 899 (09.00am-06.00pm, Sat 10.00am-02.00pm)  
€ 0.05ppm peak, €0.045ppm off peak Times

### Internet

<http://dlink.com>

## Technische Unterstützung

|              |          |   |
|--------------|----------|---|
| Deutschland: | Web:     | <a href="http://dlink.com">http://dlink.com</a> |
|              | Telefon: | +49(0)1805 2787 0,14 € pro Minute               |
|              | Zeiten:  | Mo. –Fr. 08:30 – 17:30 Uhr                      |
| Österreich:  | Web:     | <a href="http://dlink.com">http://dlink.com</a> |
|              | Telefon: | +43(0)820 480084 0,116 € pro Minute             |
|              | Zeiten:  | Mo. –Fr. 08:30 – 17:30 Uhr                      |
| Schweiz:     | Web:     | <a href="http://dlink.com">http://dlink.com</a> |
|              | Telefon: | +41(0)848 331100 0,08 CHF pro Minute            |
|              | Zeiten:  | Mo. –Fr. 08:30 – 17:30 Uhr                      |

\* Gebühren aus Mobilnetzen und von anderen Providern können abweichen.

## Assistance technique

Assistance technique D-Link sur internet : <http://dlink.com>  
Assistance technique D-Link par téléphone : 01 76 54 84 17  
Du lundi au vendredi de 9h à 19h (hors jours fériés)

## Asistencia Técnica

Asistencia Técnica Telefónica de D-Link: +34 902 30 45 45  
0,067 €/min  
De Lunes a Viernes de 9:00 a 19:00  
<http://dlink.com>

## Supporto tecnico

Supporto Tecnico dal lunedì al venerdì dalle ore 9.00 alle ore 19.00 con orario  
continuato  
Telefono: 02 87366396  
<http://dlink.com>

## TECHNISCHE ONDERSTEUNING

Technische ondersteuning voor klanten in Nederland:  
<http://dlink.com> / 0107994325 / €0.15per minuut.  
Tech Support for customers within Belgium:  
<http://dlink.com> / 028801640 / €0.175per minuut(spitsuren), €0.0875per minuut(daluren)  
Technische ondersteuning voor klanten in Luxemburg:  
<http://dlink.com> / +32 70 66 06 40

## Pomoc techniczna

Telefoniczna pomoc techniczna firmy D-Link: 0 801 022 021  
Pomoc techniczna firmy D-Link świadczona przez Internet:  
<http://dlink.com>

## Technická podpora

Web: <http://dlink.com>  
E-mail: [support@dlink.cz](mailto:support@dlink.cz)  
Telefon ČR: +420 211 151 640 nebo SK: +421 (0)692 147 110  
Telefonická podpora je v provozu: PO - PÁ od 09:00 do 17:00  
Volání je zpoplatněno dle příslušných tarifů Vašeho operátora.

## Technikai Támogatás

Tel. : 06 1 461-3001  
Fax : 06 1 461-3004  
Land Line 14,99 HUG/min - Mobile 49.99,HUF/min  
email : [support@dlink.hu](mailto:support@dlink.hu)  
URL : <http://dlink.com>

## Teknisk Support

D-Link Teknisk Support over Internett: <http://dlink.com>  
D-Link Teknisk telefonsupport: 815 69 755  
(Hverdager 08:00 - 17:00)

## Teknisk Support

D-Link teknisk support over telefonen: Tlf.: 702 690 40  
Normale åbningstider: Hverdage kl. 08:00 - 17:00  
D-Link teknisk support på Internettet: <http://dlink.com>



## **Teknistä tukea asiakkaille Suomessa:**

Internetin kautta : <http://dlink.com>

Arkisin klo. 09:00 - 18: 00

Numerosta : 0200-555 57

## **Teknisk Support**

D-Link Teknisk Support via Internet: <http://dlink.com>

D-Link Teknisk Support via telefon: 0770-33 00 35

Vardagar 08:00 - 17:00

## **Assistência Técnica**

Assistência Técnica da D-Link na Internet:

<http://dlink.com>

e-mail: [soporte@dlink.es](mailto:soporte@dlink.es)

## **Τεχνική Υποστήριξη**

D-Link Hellas Support Center

<http://dlink.com>

Καλύμνου 12, 112 51, Αθήνα

Τηλ. 213 0020353 (Δευτέρα - Παρασκευή, 09.00 - 19.00)

Fax. 210 8653172

## **Tehnička podrška**

Hvala vam na odabiru D-Link proizvoda. Za dodatne informacije, podršku i upute za korištenje uređaja, molimo vas da posjetite D-Link internetsku stranicu na [www.dlink.eu](http://www.dlink.eu)  
<http://dlink.com>

## **Tehnična podpora**

Zahvaljujemo se vam, ker ste izbrali D-Link proizvod. Za vse nadaljnje informacije, podporo ter navodila za uporabo prosimo obiščite D-Link - ovo spletno stran [www.dlink.eu](http://www.dlink.eu)  
<http://dlink.com>

## **Suport tehnic**

Vă mulțumim pentru alegerea produselor D-Link. Pentru mai multe informații, suport și manuale ale produselor vă rugăm să vizitați site-ul D-Link [www.dlink.eu](http://www.dlink.eu)  
<http://dlink.com>

# Technical Support

You can find software updates and user documentation on the D-Link website.

## Tech Support for customers in

### Australia:

Tel: 1300-766-868  
24/7 Technical Support  
Web: <http://www.dlink.com.au>  
E-mail: [support@dlink.com.au](mailto:support@dlink.com.au)

### India:

Tel: +91-832-2856000  
Toll Free 1800-233-0000  
Web: [www.dlink.co.in](http://www.dlink.co.in)  
E-Mail: [helpdesk@dlink.co.in](mailto:helpdesk@dlink.co.in)

### Singapore, Thailand, Indonesia, Malaysia, Philippines, Vietnam:

Singapore - [www.dlink.com.sg](http://www.dlink.com.sg)  
Thailand - [www.dlink.co.th](http://www.dlink.co.th)  
Indonesia - [www.dlink.co.id](http://www.dlink.co.id)  
Malaysia - [www.dlink.com.my](http://www.dlink.com.my)  
Philippines - [www.dlink.com.ph](http://www.dlink.com.ph)  
Vietnam - [www.dlink.com.vn](http://www.dlink.com.vn)

### Korea:

Tel : +82-2-2028-1810  
Monday to Friday 9:00am to 6:00pm  
Web : <http://d-link.co.kr>  
E-mail : [g2b@d-link.co.kr](mailto:g2b@d-link.co.kr)

### New Zealand:

Tel: 0800-900-900  
24/7 Technical Support  
Web: <http://www.dlink.co.nz>  
E-mail: [support@dlink.co.nz](mailto:support@dlink.co.nz)

### South Africa and Sub Sahara Region:

Tel: +27 12 661 2065  
08600 DLINK (for South Africa only)  
Monday to Friday 8:30am to 9:00pm South Africa Time  
Web: <http://www.d-link.co.za>  
E-mail: [support@d-link.co.za](mailto:support@d-link.co.za)

### Saudi Arabia (KSA):

Tel: +966 01 217 0008  
Fax: +966 01 217 0009  
Saturday to Wednesday 9.30AM to 6.30PM  
Thursdays 9.30AM to 2.00 PM  
E-mail: [Support.sa@dlink-me.com](mailto:Support.sa@dlink-me.com)

### D-Link Middle East - Dubai, U.A.E.

Plot No. S31102,  
Jebel Ali Free Zone South,  
P.O.Box 18224, Dubai, U.A.E.  
Tel: +971-4-8809022  
Fax: +971-4-8809066 / 8809069  
Technical Support: +971-4-8809033  
General Inquiries: [info.me@dlink-me.com](mailto:info.me@dlink-me.com)  
Tech Support: [support.me@dlink-me.com](mailto:support.me@dlink-me.com)

### Egypt

1, Makram Ebeid Street - City Lights Building  
Nasrcity - Cairo, Egypt  
Floor 6, office C2  
Tel.: +2 02 26718375 - +2 02 26717280  
Technical Support: +2 02 26738470  
General Inquiries: [info.eg@dlink-me.com](mailto:info.eg@dlink-me.com)  
Tech Support: [support.eg@dlink-me.com](mailto:support.eg@dlink-me.com)

### Kingdom of Saudi Arabia

Office # 84 ,  
Al Khaleej Building ( Mujamathu Al-Khaleej)  
Opp. King Fahd Road, Olaya  
Riyadh - Saudi Arabia  
Tel: +966 1 217 0008  
Technical Support:  
+966 1 2170009 / +966 2 6522951  
General Inquiries: [info.sa@dlink-me.com](mailto:info.sa@dlink-me.com)  
Tech Support: [support.sa@dlink-me.com](mailto:support.sa@dlink-me.com)

### Pakistan

Islamabad Office:  
61-A, Jinnah Avenue, Blue Area,  
Suite # 11, EBC, Saudi Pak Tower,  
Islamabad - Pakistan  
Tel.: +92-51-2800397, 2800398  
Fax: +92-51-2800399

### Karachi Office:

D-147/1, KDA Scheme # 1,  
Opposite Mudassir Park, Karsaz Road,  
Karachi – Pakistan  
Phone: +92-21-34548158, 34326649  
Fax: +92-21-4375727  
Technical Support: +92-21-34548310, 34305069  
General Inquiries: [info.pk@dlink-me.com](mailto:info.pk@dlink-me.com)  
Tech Support: [support.pk@dlink-me.com](mailto:support.pk@dlink-me.com)

## Technical Support

You can find software updates and user documentation on the D-Link website.

### Tech Support for customers in

#### Iran

Unit 5, 5th Floor, No. 20, 17th Alley , Bokharest  
St. , Argentine Sq. ,  
Tehran IRAN  
Postal Code : 1513833817  
Tel: +98-21-88880918,19  
+98-21-88706653,54  
General Inquiries: info.ir@dlink-me.com  
Tech Support: support.ir@dlink-me.com

#### Israel

רח' המגשימים 20  
קרית מטלון, פ"ת 49348  
ת.ד. 7060  
טלפון: 073-796-2797  
אי-מאייל כללי: info@dlink.co.il  
אי-מאייל תמיכה: support@dlink.co.il

#### Morocco

M.I.T.C  
Route de Nouaceur angle RS et CT 1029  
Bureau N° 312 ET 337  
Casablanca , Maroc  
Phone : +212 663 72 73 24  
Email: support.na@dlink-me.com

#### Lebanon RMA center

Dbayeh/Lebanon  
PO Box:901589  
Tel: +961 4 54 49 71 Ext:14  
Fax: +961 4 54 49 71 Ext:12  
Email: taoun@dlink-me.com

#### Bahrain

Technical Support: +973 1 3332904

#### Kuwait:

Technical Support: + 965 22453939 / +965  
22453949

#### Türkiye Merkez İrtibat Ofisi

Ayazağa Maslak yolu  
Erdebil Cevahir İş Merkezi No: 5/A Ayazağa /  
Maslak İstanbul  
Tel: +90 212 2895659  
Ücretsiz Müşteri Destek Hattı: 0 800 211 00 65  
Web:www.dlink.com.tr  
Teknik Destek: support.tr@dlink.com.tr

## Техническая поддержка

Обновления программного обеспечения и документация доступны на Интернет-сайте D-Link. D-Link предоставляет бесплатную поддержку для клиентов в течение гарантийного срока. Клиенты могут обратиться в группу технической поддержки D-Link по телефону или через Интернет.

### Техническая поддержка D-Link:

8-800-700-5465

### Техническая поддержка через Интернет:

<http://www.dlink.ru>

e-mail: [support@dlink.ru](mailto:support@dlink.ru)

## Офисы

### Россия

129626 г. Москва

Графский пер., 14

Тел.: +7 (495) 744-0099

### Украина,

04080 г. Киев, ул. Межигорская, 87-А, офис 18

Тел.: +38 (044) 545-64-40

E-mail: [kiev@dlink.ru](mailto:kiev@dlink.ru)

### Беларусь

220114, г. Минск, проспект Независимости, 169, БЦ "XXI Век"

Тел.: +375(17) 218-13-65

E-mail: [minsk@dlink.ru](mailto:minsk@dlink.ru)

### Казахстан,

050008, г. Алматы, ул. Курмангазы, 143

(уг. Муқанова)

Тел./факс: +7 727 378-55-90

E-mail: [almaty@dlink.ru](mailto:almaty@dlink.ru)

### Армения

0038, г. Ереван, ул. Абеяна, 6/1, 4 этаж

Тел./Факс: + 374 (10) 398-667

E-mail: [erevan@dlink.ru](mailto:erevan@dlink.ru)

### Грузия

Тел./Факс: +995 (593) 98-3210

### Lietuva

09120, Vilnius, Žirmūnų 139-303

Tel./faks. +370 (5) 236-3629

E-mail: [info@dlink.lt](mailto:info@dlink.lt)

### Eesti

Mustamae 55-314

10621, Tallinn

Tel +372 613 9771

e-mail: [info@dlink.ee](mailto:info@dlink.ee)

### Latvija

Mazā nometņu 45/53 (ieeja no Nāras ielas)

LV-1002, Rīga

Tel.:+371 7 618-703

Fax: +371 7 618-706

e-pasts: [info@dlink.lv](mailto:info@dlink.lv)

## SOPORTE TÉCNICO

Usted puede encontrar actualizaciones de softwares o firmwares y documentación para usuarios a través de nuestro sitio [www.dlinkla.com](http://www.dlinkla.com)

### SOPORTE TÉCNICO PARA USUARIOS EN LATINO AMERICA

Soporte técnico a través de los siguientes teléfonos de D-Link

| PAIS        | NUMERO           |
|-------------|------------------|
| Argentina   | 0800 - 12235465  |
| Chile       | 800 260200       |
| Colombia    | 01800 - 510070   |
| Costa Rica  | 0800 - 0521478   |
| Ecuador     | 1800 - 035465    |
| El Salvador | 800 - 6335       |
| Guatemala   | 1800 - 8350255   |
| México      | 01800 - 0626270  |
| Panamá      | 011 008000525465 |
| Perú        | 0800 - 00968     |
| Venezuela   | 0800 - 1005767   |

### Soporte Técnico de D-Link a través de Internet

Horario de atención Soporte Técnico en [www.dlinkla.com](http://www.dlinkla.com)

e-mail: [soporte@dlinkla.com](mailto:soporte@dlinkla.com) & [consultas@dlinkla.com](mailto:consultas@dlinkla.com)

**D-Link**<sup>®</sup>  
Building Networks for People

## Suporte Técnico

Caso tenha dúvidas na instalação do produto, entre em contato com o Suporte Técnico D-Link.

Acesse o site: [www.dlink.com.br/suporte](http://www.dlink.com.br/suporte)



## D-Link 友訊科技 台灣分公司 技術支援資訊

如果您還有任何本使用手冊無法協助您解決的產品相關問題，台灣地區用戶可以透過我們的網站、電子郵件或電話等方式與D-Link台灣地區技術支援工程師聯絡。

**D-Link 免付費技術諮詢專線**

0800-002-615

手機付費電話 (02)6600-0123#8715

服務時間：週一至週五，早上9:00到晚上9:00

(不含周六、日及國定假日)

網 站：<http://www.dlink.com.tw>

電子郵件：[dssqa\\_service@dlink.com.tw](mailto:dssqa_service@dlink.com.tw)

如果您是台灣地區以外的用戶，請參考D-Link網站全球各地分公司的聯絡資訊以取得相關支援服務。

產品保固期限、台灣區維修據點查詢，請參考以下網頁說明：

<http://www.dlink.com.tw>

產品維修：

使用者可直接送至全省聯強直營維修站或請洽您的原購買經銷商。

**D-Link®**  
Building Networks for People



## **Dukungan Teknis**

Update perangkat lunak dan dokumentasi pengguna dapat diperoleh pada situs web D-Link.

### **Dukungan Teknis untuk pelanggan:**

#### **Dukungan Teknis D-Link melalui telepon:**

Tel: +62-21-5731610

#### **Dukungan Teknis D-Link melalui Internet:**

Email : [support@dlink.co.id](mailto:support@dlink.co.id)

Website : <http://support.dlink.co.id>



## Technical Support

この度は弊社製品をお買い上げいただき、誠にありがとうございます。  
させていただきます。

下記弊社 Web サイトからユーザ登録及び新製品登録を  
行っていただき、ダウンロードサービスにて  
サポート情報、ファームウェア、ユーザマニュアルを  
ダウンロードすることができます。

ディーリンクジャパン Web サイト

URL:<http://www.dlink-jp.com>

**D-Link<sup>®</sup>**  
Building Networks for People

## 技术支持

办公地址：北京市朝阳区将台路 5 号院 5 号楼 邮编：100016

技术支持中心电话：400-629-6688

技术支持中心传真：(028)-61317620

各地维修中心地址请登陆官方网站查询

网址：<http://www.dlink.com.cn>

400电话工作时间：工作日9:00-19:00；节假日9:00-18:00.

**D-Link**<sup>®</sup>  
Building Networks for People

# Registration Card

## All Countries and Regions Excluding USA

*Print, type or use block letters.*

Your name: Mr./Ms \_\_\_\_\_

Organization: \_\_\_\_\_ Dept. \_\_\_\_\_

Your title at organization: \_\_\_\_\_

Telephone: \_\_\_\_\_ Fax: \_\_\_\_\_

Organization's full address: \_\_\_\_\_

Country: \_\_\_\_\_

Date of purchase (Month/Day/Year): \_\_\_\_\_

| Product Model | Product Serial No. | * Product installed in type of computer | * Product installed in computer serial No. |
|---------------|--------------------|---|--|
|               |                    |   |  |
|               |                    |   |  |
|               |                    |   |  |
|               |                    |   |  |
|               |                    |   |  |

(\* Applies to adapters only)

*Product was purchased from:*

Reseller's name: \_\_\_\_\_

Telephone: \_\_\_\_\_

**Answers to the following questions help us to support your product:**

**1. Where and how will the product primarily be used?**

Home Office Travel Company Business Home Business Personal Use

**2. How many employees work at installation site?**

1 employee 2-9 10-49 50-99 100-499 500-999 1000 or more

**3. What network protocol(s) does your organization use ?**

XNS/IPX TCP/IP DECnet Others \_\_\_\_\_

**4. What network operating system(s) does your organization use ?**

D-Link LANsmart Novell NetWare NetWare Lite SCO Unix/Xenix PC NFS 3Com 3+Open Cisco Network

Banyan Vines DECnet Pathwork Windows NT Windows 98 Windows 2000/ME Windows XP

Others \_\_\_\_\_

**5. What network management program does your organization use ?**

D-View HP OpenView/Windows HP OpenView/Unix SunNet Manager Novell NMS

NetView 6000 Others \_\_\_\_\_

**6. What network medium/media does your organization use ?**

Fiber-optics Thick coax Ethernet Thin coax Ethernet 10BASE-T UTP/STP

100BASE-TX 1000BASE-T Wireless 802.11b and 802.11g wireless 802.11a Others \_\_\_\_\_

**7. What applications are used on your network?**

Desktop publishing Spreadsheet Word processing CAD/CAM

Database management Accounting Others \_\_\_\_\_

**8. What category best describes your company?**

Aerospace Engineering Education Finance Hospital Legal Insurance/Real Estate Manufacturing

Retail/Chain store/Wholesale Government Transportation/Utilities/Communication VAR

System house/company Other \_\_\_\_\_

**9. Would you recommend your D-Link product to a friend?**

Yes No Don't know yet

**10. Your comments on this product?**

\_\_\_\_\_

\_\_\_\_\_

PLEASE  
PLACE STAMP  
HERE

**TO:**

---

---

---

**D-Link®**

## Free Manuals Download Website

<http://myh66.com>

<http://usermanuals.us>

<http://www.somanuals.com>

<http://www.4manuals.cc>

<http://www.manual-lib.com>

<http://www.404manual.com>

<http://www.luxmanual.com>

<http://aubethermostatmanual.com>

Golf course search by state

<http://golfingnear.com>

Email search by domain

<http://emailbydomain.com>

Auto manuals search

<http://auto.somanuals.com>

TV manuals search

<http://tv.somanuals.com>