

Dell Storage Center SC180 Expansion Enclosure Owner's Manual

Regulatory Model: E11J
Regulatory Type: E11J001



Notes, Cautions, and Warnings

 **NOTE:** A NOTE indicates important information that helps you make better use of your computer.

 **CAUTION:** A CAUTION indicates either potential damage to hardware or loss of data and tells you how to avoid the problem.

 **WARNING:** A WARNING indicates a potential for property damage, personal injury, or death.

Copyright © 2015 Dell Inc. All rights reserved. This product is protected by U.S. and international copyright and intellectual property laws. Dell™ and the Dell logo are trademarks of Dell Inc. in the United States and/or other jurisdictions. All other marks and names mentioned herein may be trademarks of their respective companies.

2015 - 03

Rev. A00

Contents

About this Guide.....	5
Revision History.....	5
Audience.....	5
Contacting Dell.....	5
Related Publications.....	5
1 About the SC180 Expansion Enclosure.....	7
SC180 Expansion Enclosure Overview.....	7
SC180 Expansion Enclosure Monitoring and Diagnostics.....	7
SC180 Expansion Enclosure Front-Panel Features and Indicators.....	7
SC180 Expansion Enclosure Back-Panel Features and Indicators.....	9
SC180 Expansion Enclosure EMM Features and Indicators.....	10
SC180 Expansion Enclosure Fan Module Features and Indicators.....	11
SC180 Expansion Enclosure PSU Features and Indicators.....	12
SC180 Expansion Enclosure Drives.....	12
2 Replacing SC180 Components.....	14
Safety Precautions.....	14
Installation Safety Precautions.....	14
Electrical Safety Precautions.....	15
Electrostatic Discharge Precautions.....	15
General Safety Precautions.....	15
Pre-Replacement Procedures.....	16
Sending Diagnostic Data Using Dell SupportAssist.....	16
Contacting Dell Technical Support Services.....	16
Shutting Down the Storage System and Expansion Enclosures.....	16
Replacing PSUs.....	17
Identifying the Failed PSU.....	17
Replacing a PSU.....	18
Replacing Cooling Fan Modules.....	20
Identifying the Failed Cooling Fan Module.....	20
Replacing a Cooling Fan Module.....	21
Replacing Hard Drives.....	23
SC180 Expansion Enclosure Drive Numbering.....	23
Identifying the Failed Hard Drive.....	23
Replacing a Hard Drive.....	24
Replacing an Enclosure Management Module.....	27

Identifying the Failed Enclosure Management Module.....	28
Replacing an Enclosure Management Module.....	29
Replacing Rack Rails.....	30
Post-Replacement Procedures.....	31
Start Up the Storage System and Expansion Enclosure.....	31
Sending Diagnostic Data Using Dell SupportAssist.....	31
Contact Dell Technical Support Services.....	31
3 Troubleshooting SC180 Components.....	32
Troubleshooting Fan Modules.....	32
Troubleshooting PSUs.....	32
Troubleshooting Disk Drives.....	32
Troubleshooting EMMs.....	33
4 SC180 Technical Specifications.....	34
Technical Specifications.....	34

About this Guide

This guide describes how to perform service and maintenance on an SC180 expansion enclosure.

Revision History

Document Number: MV429

Revision	Date	Description
A00	March 2015	Initial release

Audience

The information provided in this Owner's Manual is intended for use by Dell end users.

Contacting Dell

Dell provides several online and telephone-based support and service options. Availability varies by country and product, and some services may not be available in your area.

To contact Dell for sales, technical support, or customer service issues go to www.dell.com/support.

- For customized support, enter your system Service Tag on the support page and click **Submit**.
- For general support, browse the product list on the support page and select your product.

Related Publications

The following documentation is available for the SC180 expansion enclosure.

- *Dell Storage Center SC180 Expansion Enclosure Getting Started Guide*
Provides information about an SC180 expansion enclosure, such as installation instructions and technical specifications.
- *Dell Storage Center Release Notes*
Contains information about new features and known and resolved issues for the Storage Center software.
- *Dell Storage Center SCv2000 Series Virtual Media Update Instructions*
Describes how to install Storage Center software on an SCv2000/SCv2020 storage system using virtual media. Installing Storage Center software using the Storage Center Virtual Media option is intended for use only by sites that cannot update Storage Center using standard methods.
- *Dell Storage Center Software Update Guide*
Describes how to upgrade Storage Center software from an earlier version to the current version.
- *Dell Storage Center Command Utility Reference Guide*

Provides instructions for using the Storage Center Command Utility. The Command Utility provides a command-line interface (CLI) to enable management of Storage Center functionality on Windows, Linux, Solaris, and AIX platforms.

- *Dell Storage Center Command Set for Windows PowerShell*
Provides instructions for getting started with Windows PowerShell cmdlets and scripting objects that interact with the Storage Center via the PowerShell interactive shell, scripts, and PowerShell hosting applications. Help for individual cmdlets is available online.
- *Dell Storage Client Administrator's Guide*
Provides information about the Dell Storage Client and how it can be used to manage a Storage Center.
- *Dell Enterprise Manager Administrator's Guide*
Contains in-depth feature configuration and usage information
- *Dell TechCenter*
Provides technical white papers, best practice guides, and frequently asked questions about Dell Storage products. Go to: <http://en.community.dell.com/techcenter/storage/>.

About the SC180 Expansion Enclosure

An SC180 expansion enclosure provides expansion storage for an SCv2080 storage controller. The SC180 connects directly to the SAS ports on the back of the storage system.

SC180 Expansion Enclosure Overview

The SC180 is a 5U SAS expansion enclosure that supports up to 84 internal 3.5-inch hard drives installed in a two-drawer, three-row, 14-column configuration.

The SC180 expansion enclosure ships with two redundant power supply units, five redundant cooling fans, and two redundant Enclosure Management Modules (EMMs).

SC180 Expansion Enclosure Monitoring and Diagnostics

The Storage Center OS generates alert messages for temperature, I/O module, fan module, disk, and power conditions for Storage Center components. Use the Dell Storage Client to view these alerts.

The SC180 also has LED indicators to notify you of a possible problem with the expansion enclosure.

 **NOTE:** Dell OpenManage Server Administrator is not available for the SC180.

SC180 Expansion Enclosure Front-Panel Features and Indicators

The SC180 front panel shows the expansion enclosure and power status.

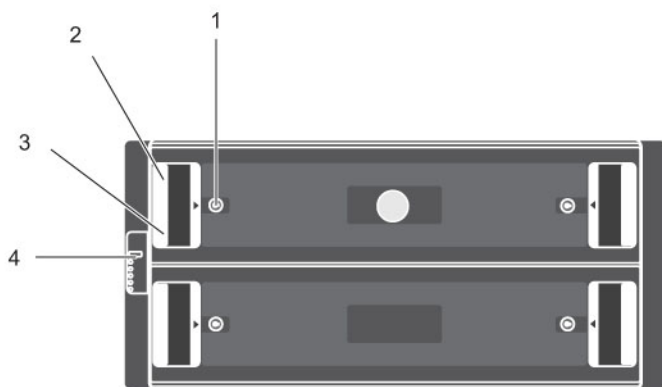











Figure 1. SC180 Front-Panel Features and Indicators

Item	Name	Panel	Description
1	Drawer-specific anti-tamper locks		Locks the drawer shut using a Torx T20 screwdriver until the red arrows point to the locked icon (away from the center of the chassis).
2	Drawer-specific left and right side status indicators		<ul style="list-style-type: none"> • Sideplane OK/Power Good: <ul style="list-style-type: none"> – Off – Sideplane card or cable fault – Green – Sideplane card and cable are functional (though a fault may be indicated by one or more of the following LEDs) • Drawer Fault: Amber – Sideplane card fault or drive failure causing loss of availability or redundancy • Logical Fault: <ul style="list-style-type: none"> – Amber (steady) – Host indicated drive fault – Amber (flashing) – Arrays in impacted state • Cable Fault: Amber – Cable fault
3	Drawer-specific left and right side expansion enclosure activity indicators		<p>Activity Bar Graph: Six variable-intensity LEDs dynamically displaying access of the drives in that specific drawer.</p>
4	Status indicator for expansion enclosure	 	<ul style="list-style-type: none"> • Unit ID Display: A numerical display whose primary function is to display the unit identification number. • Input Switch: Not currently used (though it can be used to set the Unit ID Display, the ID will be automatically reset by the Storage Center Operating System) • Power On/Standby: <ul style="list-style-type: none"> – Off – The expansion enclosure does not have power – Green – The expansion enclosure is on (operational) – Amber – The expansion enclosure is in standby (not operational) • Module Fault: Amber when there is a hardware fault (additionally, an LED may be lit on a PSU, drawer, DDIC, fan module, or IO module indicating the part at fault)

Item	Name	Panel	Description
			<ul style="list-style-type: none"> • Logical Status: Amber when there is a change of status or fault from something other than the expansion enclosure itself (this may be from an external RAID controller or HBA, but is usually associated with a disk drive as indicated by its own fault LED)
			<ul style="list-style-type: none"> • Drawer 1 Fault: Amber when a drive, cable, or sideplane fault has occurred in drawer 1
			<ul style="list-style-type: none"> • Drawer 2 Fault: Amber when a drive, cable, or sideplane fault has occurred in drawer 2
		 NOTE:	Both drawer fault LEDs (and all contained DDIC LEDs) will flash when the expansion enclosure indicator is set to On in Storage Client.

SC180 Expansion Enclosure Back-Panel Features and Indicators

The SC180 back panel shows power, connectivity, and fault indicators.

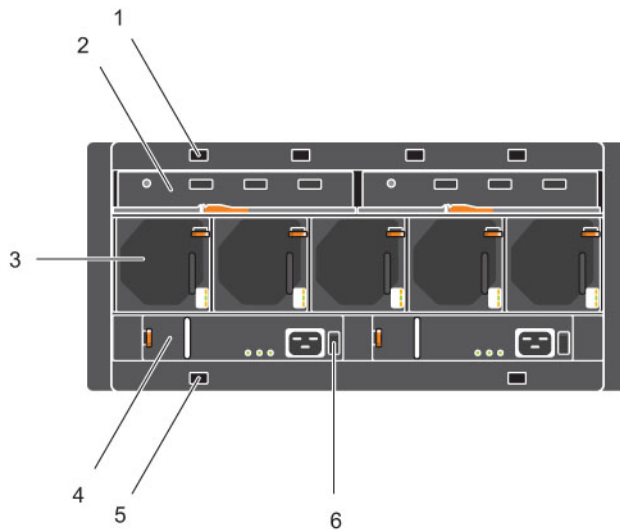

Figure 2. SC180 Back-Panel Features and Indicators

Item	Name	Icon	Description
1	Optional cable retention positions (4)	—	Locations for optional cable retention brackets.
2	Expansion Enclosure Modules (2)	—	Each EMM contains SAS ports and status indicators.
3	Cooling fans (5)	—	Fans that provide cooling for the expansion enclosure.
4	Power supply units (2)	—	2.8 kW power supply that provides power for the expansion enclosure.
5	Optional cable retention positions (4)	—	Locations for optional cable retention brackets.
6	Power switch (2)	—	Controls power for the expansion enclosure. There is one switch for each power supply.

SC180 Expansion Enclosure EMM Features and Indicators

An SC180 expansion enclosure includes two Enclosure Management Modules (EMMs) in two Storage Bridge Bay (SBB) interface slots.

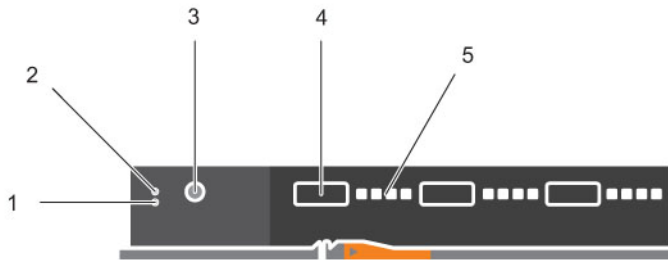

Figure 3. SC180 EMM Features and Indicators

Item	Control/Feature	Icon	Description
1	Fault LED	■	<ul style="list-style-type: none"> • Off — Module OK • Amber — Module fault
2	Power LED	■	<ul style="list-style-type: none"> • Green (steady) — Module OK • Green (flashing) — Vital product data (VPD) fault • Off: Module fault
3	Console port		Not for customer use.
4	SAS ports		Connect to the storage system

Item	Control/Feature	Icon	Description
5	SAS port link status indicators		<ul style="list-style-type: none"> Green (steady) – Connected, but no activity Green (flashing) – Connected plus activity Off – Not connected

SC180 Expansion Enclosure Fan Module Features and Indicators

SC180 expansion enclosures include five fan modules in five interface slots.

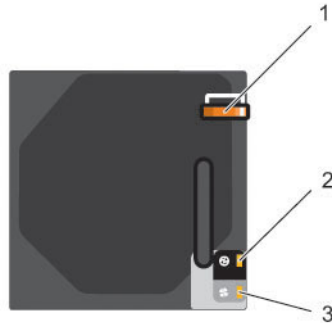



Figure 4. SC180 Fan Module Features and Indicators

Item	Control/Feature	Icon	Description
1	Release latch	—	Press the release latch to remove the fan module.
2	Module OK		Green – Module OK
3	Fan fault		Amber – Loss of communication with the fan module, or reported fan speed is out of tolerance

SC180 Expansion Enclosure PSU Features and Indicators

SC180 expansion enclosures include two Power Supply Units (PSUs) in two interface slots.

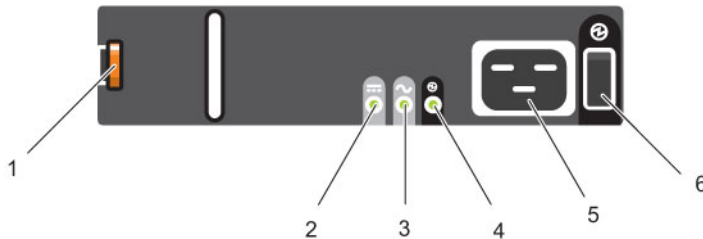





Figure 5. SC180 PSU Features and Indicators

Item	Control/Feature	Icon	Description
1	Release latch	—	Press the release latch to remove the PSU.
2	PSU fault		<ul style="list-style-type: none"> Amber (steady) — PSU fault, PSU not supplying power Amber (flashing) — PSU firmware is downloading
3	AC fault		<ul style="list-style-type: none"> Amber (steady) — AC power is not detected Amber (flashing) — PSU firmware is downloading
4	Power OK		<ul style="list-style-type: none"> Green (steady) — This PSU is providing power Green (flashing) — AC power is present, but this PSU is in standby mode (the other PSU is providing power)
5	Power outlet	—	Power outlet for the expansion enclosure.
6	Power switch	—	Controls power for the expansion enclosure.

Separate and unique conditions are indicated if all three LEDs are in the same state:

- If all three LEDs are off, then there is no AC power to either PSU.
- If all three LEDs are on, then the General Enclosure Management (GEM) software has lost communication with the PSU.

SC180 Expansion Enclosure Drives

Dell Enterprise hard disk drives (HDDs) and Enterprise Solid-State Drives (eSSDs) are the only drives that can be installed in an SC180 expansion enclosure. If a non-Dell Enterprise drive is installed, Storage Center prevents the drive from being managed.

Each drive is installed in Disk Drive In Carrier (DDIC) and each DDIC includes one status indicator.

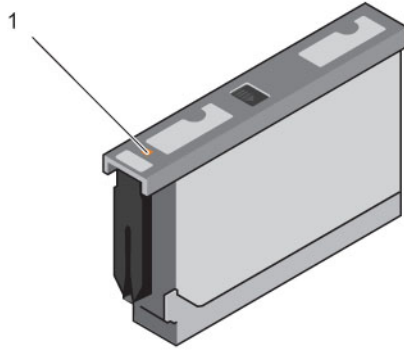

Figure 6. DDIC and Status Indicator

Item	Feature	Indicator Code
1	DDIC fault indicator	Amber – Drive fault Amber (flashing) – Flashes in one second intervals when drive or enclosure indicator is set to On in Dell Storage Client. With the drive indicator, the containing drawer fault LED will also flash; with the enclosure indicator, all drives' and both drawers' fault LEDs will flash.

Replacing SC180 Components

This section describes how to remove and install components of an SC180 expansion enclosure. This document assumes that the customer has received the replacement component and is ready to install it.

Safety Precautions

Always follow these safety precautions to avoid injury and damage to Storage Center equipment.

If equipment described in the document is used in a manner not specified by Dell, the protection provided by the equipment may be impaired. For your safety and protection, observe the rules described in the following sections.

 **NOTE:** See the safety and regulatory information that shipped with each Storage Center component. Warranty information may be included within this document or as a separate document.

Installation Safety Precautions

Follow these safety precautions:

- Dell recommends that only individuals with rack-mounting experience install an SC180 expansion enclosure in a rack.
- You need at least two people to lift the expansion enclosure chassis from the shipping box and three people to install it in the rack. The empty chassis weighs approximately 62kg (137 lbs).
- Make sure the expansion enclosure is fully grounded at all times to prevent damage from electrostatic discharge.
- When handling the expansion enclosure hardware, you should use an electrostatic wrist guard (not included) or a similar form of protection.

The expansion enclosure chassis **MUST** be mounted in a rack; the following safety requirements must be considered when doing so:

- The rack construction must be capable of supporting the total weight of the installed chassis and the design should incorporate stabilizing features suitable to prevent the rack tipping or being pushed over during installation or in normal use.
- When loading a rack with chassis, fill from the bottom up; empty from the top down.
- To avoid danger of the rack toppling over, do not slide more than one chassis out of the rack at a time.
- The expansion enclosure must be operated with low-pressure rear exhaust installation [back pressure created by rack doors and obstacles not to exceed 5 Pascals (0.5 mm water gauge)].
- The rack design should take into consideration the maximum operating ambient temperature for the unit, which is 35°C.

Electrical Safety Precautions

Always follow electrical safety precautions to avoid injury and damage to Storage Center equipment.

 **WARNING: Disconnect power from the expansion enclosure when removing or installing components that are not hot-swappable. When disconnecting power, first power down the storage system using the Dell Storage Client and then unplug the power cords from all the power supplies in the expansion enclosure.**

- Provide a suitable power source with electrical overload protection. All Storage Center components must be grounded before applying power. Make sure that there is a safe electrical earth connection to power supply cords. Check the grounding before applying power.
- The plugs on the power supply cords are used as the main disconnect device. Make sure that the socket outlets are located near the equipment and are easily accessible.
- Know the locations of the equipment power switches and the room's emergency power-off switch, disconnection switch, or electrical outlet.
- Do not work alone when working with high-voltage components.
- Use rubber mats specifically designed as electrical insulators.
- Do not remove covers from the power supply unit. Disconnect the power connection before removing a power supply from the expansion enclosure.
- Do not remove a faulty power supply unless you have a replacement model of the correct type ready for insertion. A faulty power supply must be replaced with a fully operational module power supply within 24 hours.
- Unplug the storage system chassis before you move it or if you think it has become damaged in any way. When powered by multiple AC sources, disconnect all supply power for complete isolation.

Electrostatic Discharge Precautions

Always follow electrostatic discharge (ESD) precautions to avoid injury and damage to Storage Center equipment.

Electrostatic discharge (ESD) is generated by two objects with different electrical charges coming into contact with each other. The resulting electrical discharge can damage electronic components and printed circuit boards. Follow these guidelines to protect your equipment from ESD:

- Dell recommends that you always use a static mat and static strap while working on components in the interior of the storage system chassis.
- Observe all conventional ESD precautions when handling plug-in modules and components.
- Use a suitable ESD wrist or ankle strap.
- Avoid contact with backplane components and module connectors.
- Keep all components and printed circuit boards (PCBs) in their antistatic bags until ready for use.

General Safety Precautions

Always follow general safety precautions to avoid injury and damage to Storage Center equipment.

- Keep the area around the expansion enclosure chassis clean and free of clutter.
- Place any system components that have been removed away from the expansion enclosure chassis or on a table so that they are not in the way of foot traffic.
- While working on the expansion enclosure chassis, do not wear loose clothing such as neckties and unbuttoned shirt sleeves, which can come into contact with electrical circuits or be pulled into a cooling fan.

- Remove any jewelry or metal objects from your body because they are excellent metal conductors that can create short circuits and harm you if they come into contact with printed circuit boards or areas where power is present.
- Do not lift a expansion enclosure chassis by the handles of the power supply units (PSUs). They are not designed to hold the weight of the entire chassis, and the chassis cover may become bent.
- Before moving a expansion enclosure chassis, remove the PSUs to minimize weight.
- Do not remove drives until you are ready to replace them.

 **NOTE:** To ensure proper expansion enclosure cooling, hard drive blanks must be installed in any hard drive slot that is not occupied.

Pre-Replacement Procedures

Perform the procedures described in this section before replacing a component of an SC180 expansion enclosure.

Sending Diagnostic Data Using Dell SupportAssist

Use Dell SupportAssist to send diagnostic data to Dell Technical Support Services.

1. Click **Send SupportAssist Data Now**. The **Send Support Assist Data Now** dialog box appears.
2. Select **Storage Center Configuration** and **Detailed Logs**.
3. Click **OK**.

Contacting Dell Technical Support Services

Contact Dell Technical Support Services to let them know that you are performing a repair.

Request that Dell Technical Support Services suspend alerts for the expansion enclosure and ask for a pre-installation system check.

Shutting Down the Storage System and Expansion Enclosures

If the replacement component is not hot-swappable, use the Dell Storage Client to shut down the storage system and expansion enclosures. Shutting down the storage system and expansion enclosures results in a system outage, so plan to perform these procedures during a maintenance window.

1. Before shutting down the storage system and expansion enclosures, make sure you identify the failed part.
2. From the Actions menu, select **System**→ **Shutdown/Restart**. The **Shutdown/Restart** dialog box appears.
3. Select **Shutdown** and click **OK**.
4. When the storage system and expansion enclosures are shut down, switch off both power switches and unplug the power cables from the expansion enclosure.

Replacing PSUs

The SC180 expansion enclosure supports two hot-swappable power supply units (PSUs). If one unit fails, the second unit continues to provide power to the expansion enclosure.

Identifying the Failed PSU

To determine which power supply unit (PSU) failed, use the Dell Storage Client.

1. Click the **Hardware** tab.
2. In the **Hardware** tab navigation pane, select the Storage Center.
3. In the **Hardware Alerts** area, find the hardware alert that identifies the enclosure with the failed power supply.

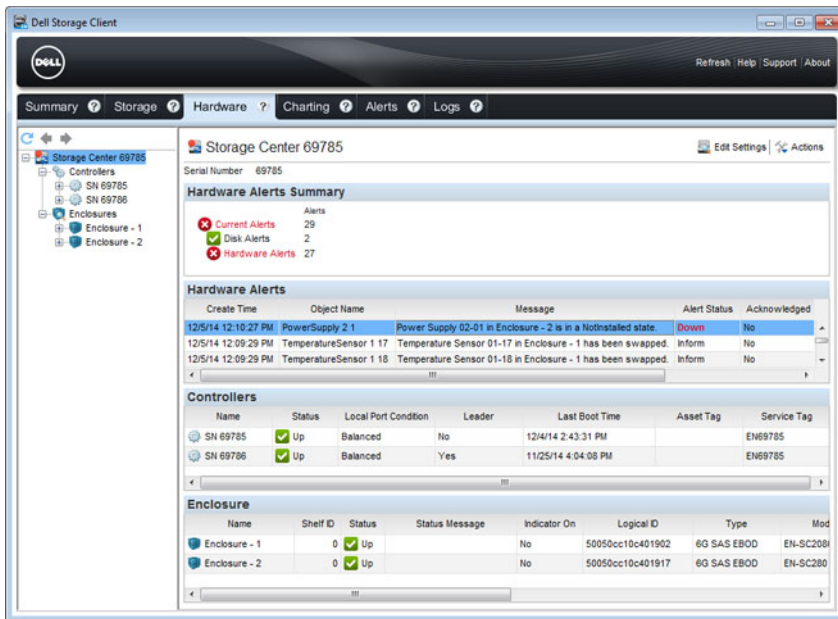

Figure 7. Hardware Alert Identifying the Enclosure with the Failed Power Supply

4. In the **Hardware** tab navigation pane, expand the enclosure identified in the previous step.
5. Select **Power Supplies**. The status of each power supply is displayed in the **Power Supplies** tab.
6. Select the failed power supply. The location of the failed power supply is displayed in the **Power Supply View** tab.

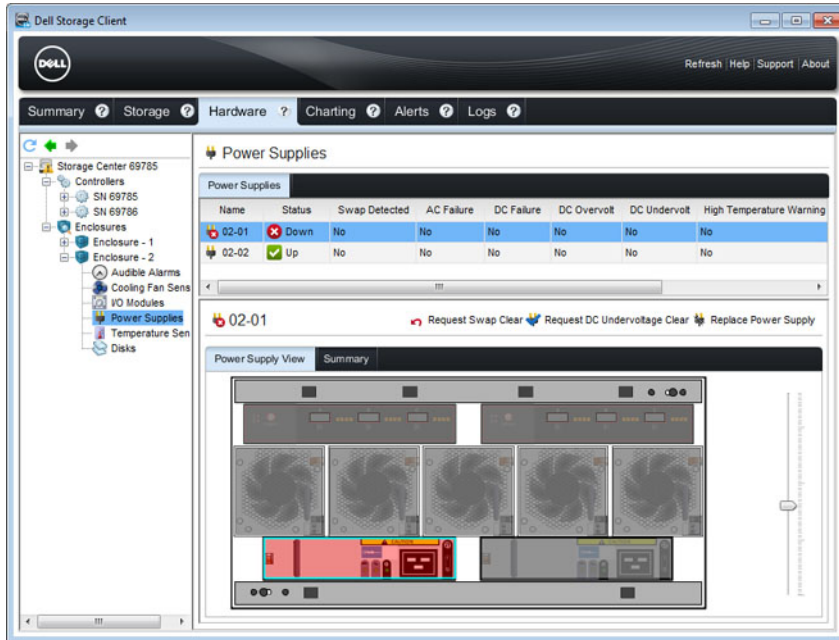

Figure 8. Rear View of the Enclosure Showing the Failed the Power Supply

Replacing a PSU

Use this procedure to replace a failed power supply unit (PSU).

Prerequisites

1. Use SupportAssist to send diagnostic data to Dell Technical Support Services.
2. Contact Dell Technical Support Services to let them know that you are performing a repair.

About this task

You can replace power supply units one at a time without shutting down the expansion enclosure.

Steps

1. Press the power switch to turn off the PSU.
2. Remove the power cable from the securing clip and disconnect the power cable from the PSU.
3. Push the release tab on the PSU to the right and slide it out of the chassis using the handle.

⚠ CAUTION: The PSUs are heavy. To avoid injury, use both hands while removing the module.

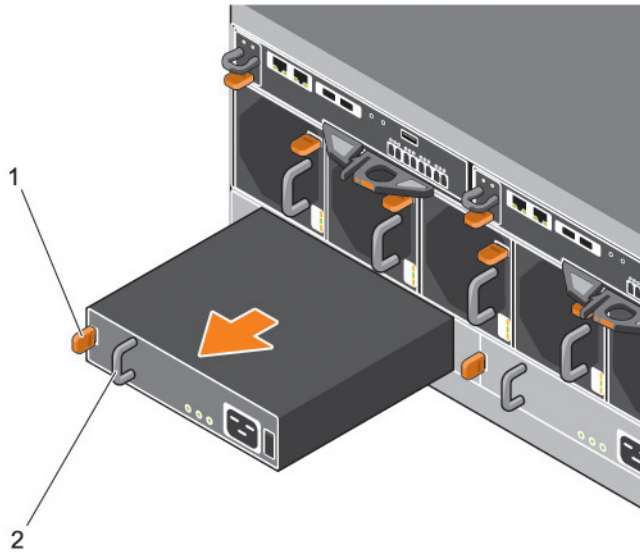

Figure 9. Removing a PSU

1. Release tab
2. Handle
4. Slide the replacement power supply unit into the chassis until it is fully seated and the release tab clicks into place.
5. Connect the power cable to the power supply unit and make sure the cable is plugged into a power outlet.
6. Secure the power cable using the clip.

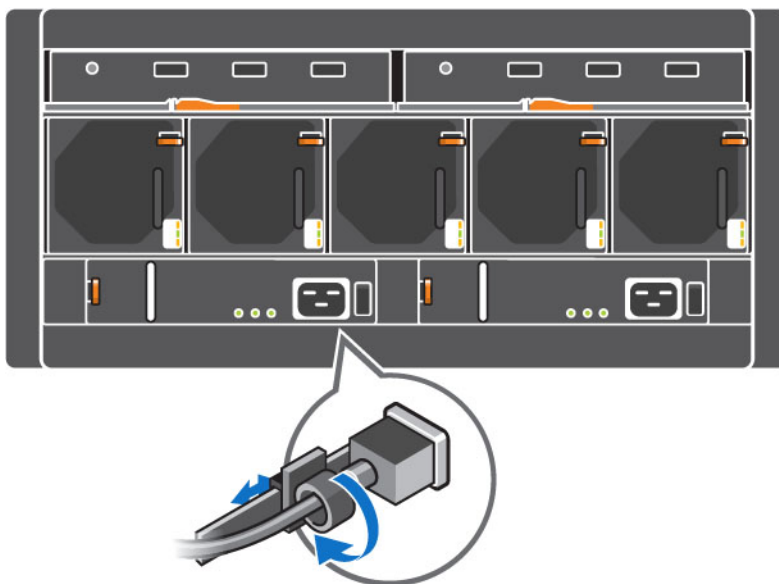

Figure 10. Securing the Power Cable

7. Press the power switch to turn on the PSU.

NOTE: Allow several seconds for the expansion enclosure to recognize the PSU and determine its status. When the PSU is functioning properly, the Power OK indicator turns green and the PSU fault and AC fault indicators are off.

8. In the Dell Storage Client, make sure that the replacement PSU is recognized and shown as up and running.

Next steps

1. Use SupportAssist to send diagnostic data to Dell Technical Support Services.
2. Contact Dell Technical Support Services to let them know that you completed a repair.

Replacing Cooling Fan Modules

The SC180 expansion enclosure supports five cooling fan modules. If one cooling fan module fails, the remaining fan modules continue to cool the expansion enclosure.

NOTE: When a cooling fan module fails, the fan speed in the remaining modules increases significantly to provide adequate cooling. The fan speed decreases gradually when a new cooling fan module is installed.

Identifying the Failed Cooling Fan Module

To determine which cooling fan module failed, use the Dell Storage Client.

1. Click the **Hardware** tab.
2. In the **Hardware** tab navigation pane, select the Storage Center.
3. In the **Hardware Alerts** area, find the hardware alert that identifies the enclosure with the failed cooling fan.

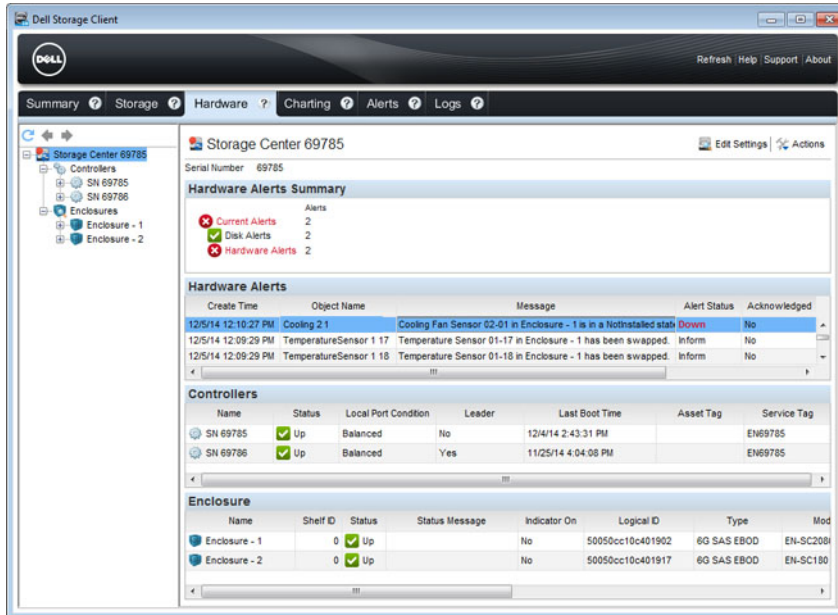

Figure 11. Hardware Alert Identifying the Enclosure with the Failed Cooling Fan

4. In the **Hardware** tab navigation pane, expand the enclosure identified in the previous step.
5. Select **Cooling Fans**. The status of each cooling fan is displayed in the **Cooling Fans** tab.

6. Select the failed cooling fan. The location of the failed cooling fan module is displayed in the **Fan View** tab.

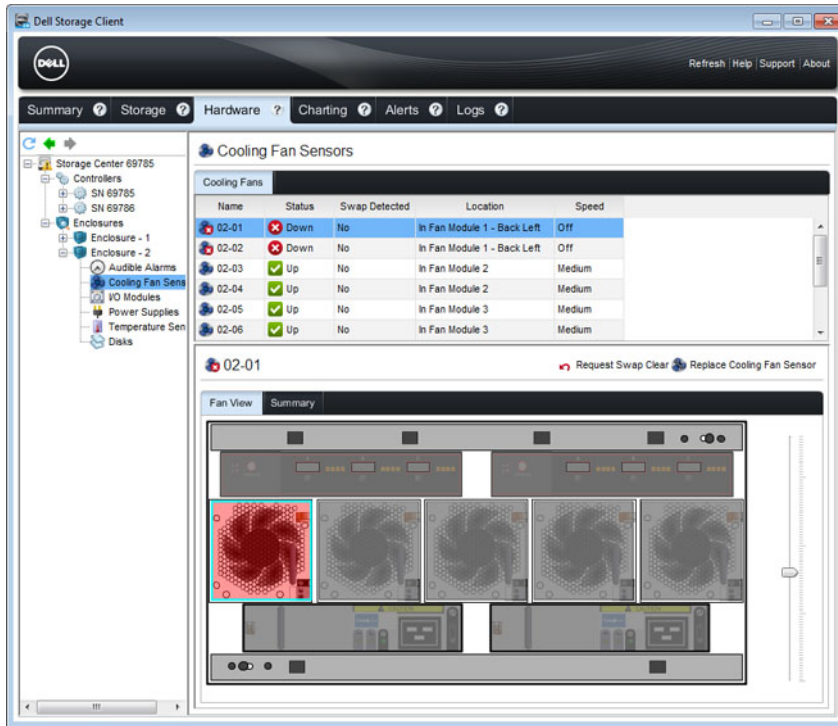

Figure 12. Rear View of the Enclosure Showing the Failed the Cooling Fan Module

Replacing a Cooling Fan Module

Use this procedure to replace a failed cooling fan module.

Prerequisites

1. Use SupportAssist to send diagnostic data to Dell Technical Support Services.
2. Contact Dell Technical Support Services to let them know that you are performing a repair.

About this task

You can replace cooling fan modules one at a time without shutting down the expansion enclosure.

Steps

1. Press the release tab and pull the fan module out of the chassis using the handle.

CAUTION: The fan modules are heavy. To avoid injury, use both hands while removing the module.

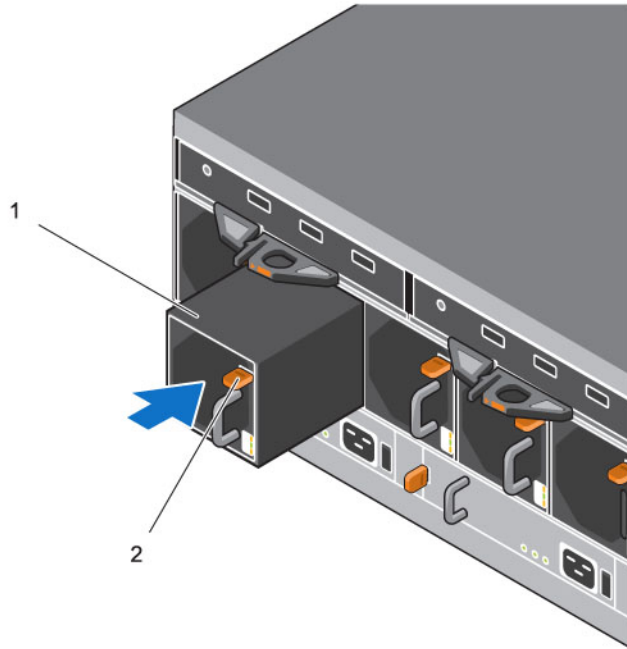

Figure 13. Removing a Fan Module

1. Fan module
 2. Release tab
2. Rotate the replacement fan module so that the release tab and handle are on the right side.
 3. Slide the replacement fan module into the chassis until it is fully seated and the release tab clicks into place.
- NOTE:** Allow several seconds for the enclosure to recognize the fan module and determine its status. When functioning properly, the fan module's Module OK LED turns green and the Battery fault and Fan fault LEDs are off. In addition, the cooling fan status indicator turns green in the Dell Storage Client.
4. In the Dell Storage Client, make sure that the replacement fan module is recognized and shown as up and running.

Next steps

1. Use SupportAssist to send diagnostic data to Dell Technical Support Services.
2. Contact Dell Technical Support Services to let them know that you completed a repair.

Replacing Hard Drives

The SC180 expansion enclosure supports up to 84 3.5-inch hot-swappable hard drives installed in a two-drawer, three-row, 14-column configuration. Hard drives are connected to a backplane using Disk Drive in Carrier (DDIC) hard drive carriers.

SC180 Expansion Enclosure Drive Numbering

In an SC180 expansion enclosure the drives are installed in a two-drawer, three-row, 14-column configuration.

The drive slots are numbered 1–42 in the top drawer and 43–84 in the bottom drawer. Dell Storage Client identifies drives as *XX-YY*, where *XX* is the number of the unit ID of the expansion enclosure, and *YY* is the drive position inside the expansion enclosure.

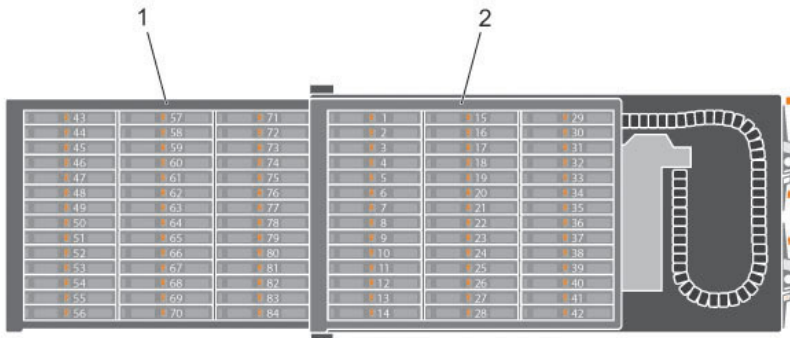

Figure 14. Hard Drive Drawers and Numbering

1. Bottom drawer
2. Top drawer

Identifying the Failed Hard Drive

To determine which hard drive failed, use the Dell Storage Client.

1. Click the **Hardware** tab.
2. In the **Hardware** tab navigation pane, select the Storage Center.
3. In the **Hardware Alerts** area, find the hardware alert that identifies the enclosure with the failed hard drive.
4. In the **Hardware** tab navigation pane, expand the enclosure identified in the previous step and select **Disks**. The status of each disk drawer is displayed in the **Disks** tab.
5. Expand the drawer with the failed hard drive and select the failed hard drive. The location of the failed hard drive is displayed in the **Disk View** tab.

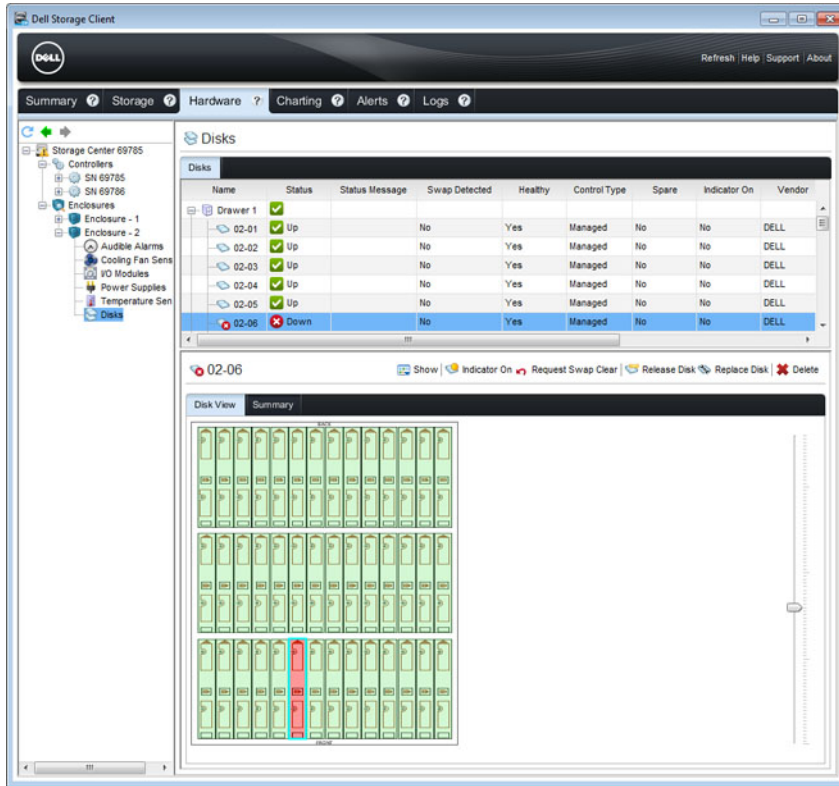

Figure 15. Inside Drawer View Showing the Failed Hard Drive

Replacing a Hard Drive

Use this procedure to replace a failed hard drive.

Prerequisites

1. Use SupportAssist to send diagnostic data to Dell Technical Support Services.
2. Contact Dell Technical Support Services to let them know that you are performing a repair.

About this task

Hard drives can be replaced one at a time without shutting down the expansion enclosure.

Steps

1. Find the SC180 and drawer containing the failed drive. The drawer fault LED will be lit.

CAUTION: Before opening a drawer, ensure that the Dell Storage Client does not display a temperature warning. This issue needs to be rectified first to avoid potential drive failure and data loss.

2. Push and hold both drawer latches toward the center of the drawer and pull the drawer all the way out until it stops.

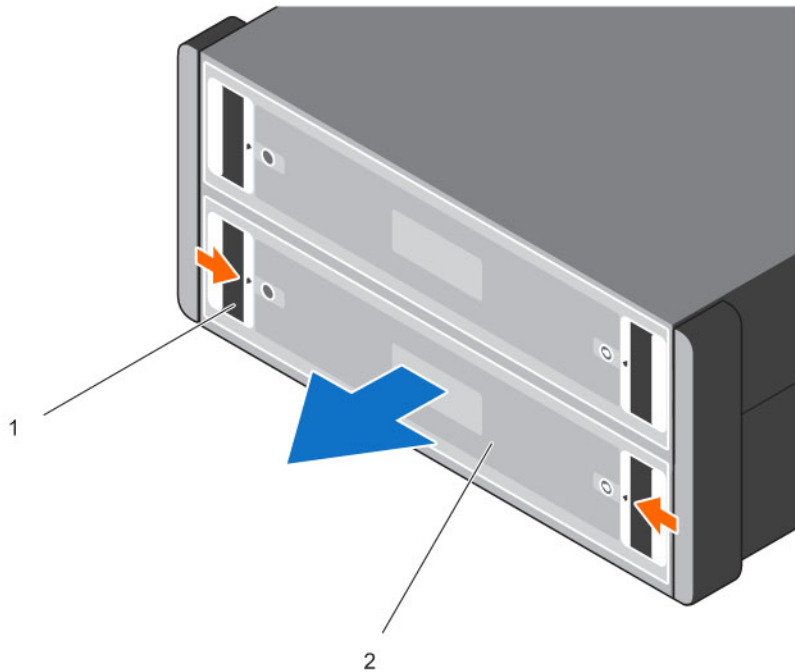

Figure 16. Opening a DDIC Drawer

1. Drawer latches (2 per drawer) 2. Drawer (2 per chassis)

⚠ CAUTION: If the SC180 operates for too long (depending on altitude) with drive drawers open, the enclosure can overheat, causing potential drive failure and data loss. Such use may invalidate the warranty.

3. Find the failed DDIC by the lit LED.
4. Press the release button to unlatch the DDIC.
5. Wait about ten (10) seconds for the drive to spin down.
6. Slide the DDIC up and out until it is free of the DDIC slot.

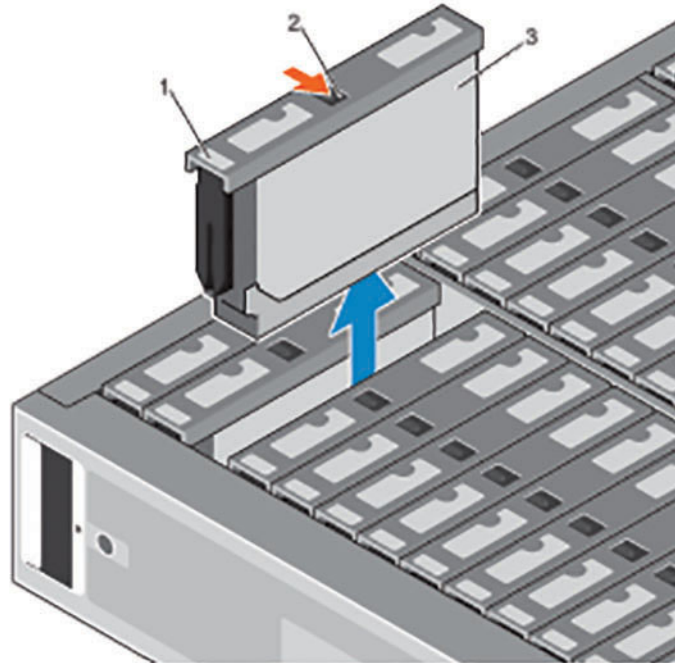

Figure 17. Removing a DDIC

1. Drive fault LED
2. Release button
3. DDIC

NOTE: Leave the drive in the carrier. The replacement drive will come in a carrier and attempting to remove the carrier can cause the carrier to break.

7. Lower the replacement DDIC into the slot then push and hold the DDIC down while sliding it toward the back of the enclosure until the DDIC latches to the backplane.

CAUTION: If the DDIC fails to latch, do not use it and request a replacement. If a faulty DDIC unlatches within a closed drawer, it can make the drawer unable to be opened.

CAUTION: To maintain proper airflow, the drawers must be populated with drives in whole rows at a time (there are three rows of 14 drives per drawer). The minimum number of drives in an enclosure is 28 (one full, front row in the top drawer and one full, front row in the bottom drawer), the number of populated rows between drawers must not differ by more than one. Populate the rows from the front to the rear of the enclosure.

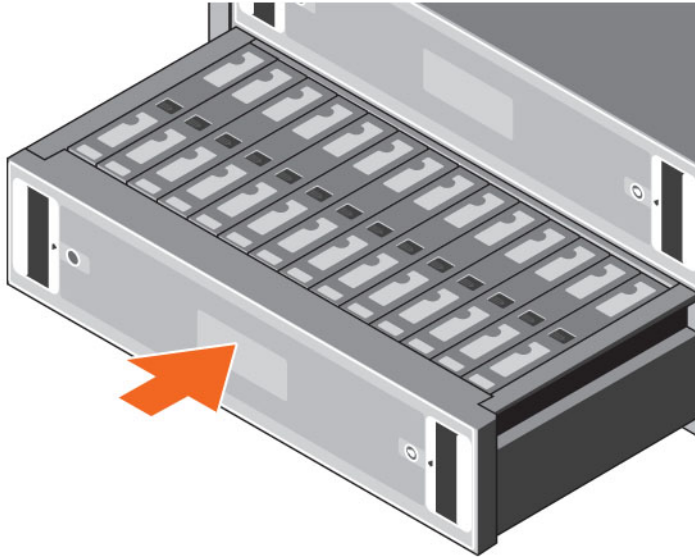



Figure 18. Closing a Drawer

8. Close the drawer.
 - a. Push and hold both drawer releases then push the drawer in slightly.
 - b. Let go of the releases and push the drawer the rest of the way in until it clicks shut.
9. In the Dell Storage Client, make sure that the replacement hard drive is recognized and shown as up and running. If the Dell Storage Client informs you that there are unassigned disks, see the *Dell Storage Client Administrator's Guide* for instructions on managing unassigned disks.
 -  **NOTE:** Allow several seconds for the enclosure to recognize the hard drive and determine its status. When functioning properly, the hard drive indicator turns green in the Dell Storage Client and the LED on the DDIC is off.

Next steps

1. Use SupportAssist to send diagnostic data to Dell Technical Support Services.
2. Contact Dell Technical Support Services to let them know that you have completed a repair.

Replacing an Enclosure Management Module

The SC180 expansion enclosures support redundant hot-swappable Enclosure Management Modules (EMMs).

EMMs provide the following data path and enclosure management functions for the expansion enclosure:

- Monitoring and controlling expansion enclosure environment elements such as temperature, fan, power supplies, and expansion enclosure LEDs
- Controlling access to hard drives
- Communicating expansion enclosure attributes and states to Storage Center

Identifying the Failed Enclosure Management Module

To determine which EMM failed, use the Dell Storage Client.

1. Click the **Hardware** tab.
2. In the **Hardware** tab navigation pane, select the Storage Center.
3. In the **Hardware Alerts** area, find the hardware alert that identifies the enclosure with the failed EMM (IO Module).

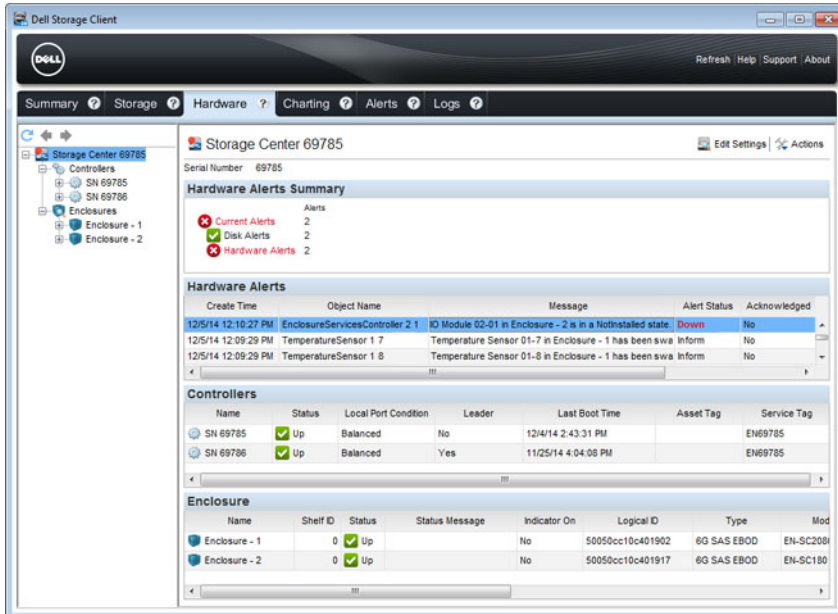

Figure 19. Hardware Alert Identifying the Enclosure with the Failed EMM

4. In the **Hardware** tab navigation pane, expand the enclosure identified in the previous step.
5. Select **I/O Modules**. The status of each EMM is displayed in the **I/O Modules** tab.
6. Select the failed EMM to display its location in the **I/O Module View** tab.

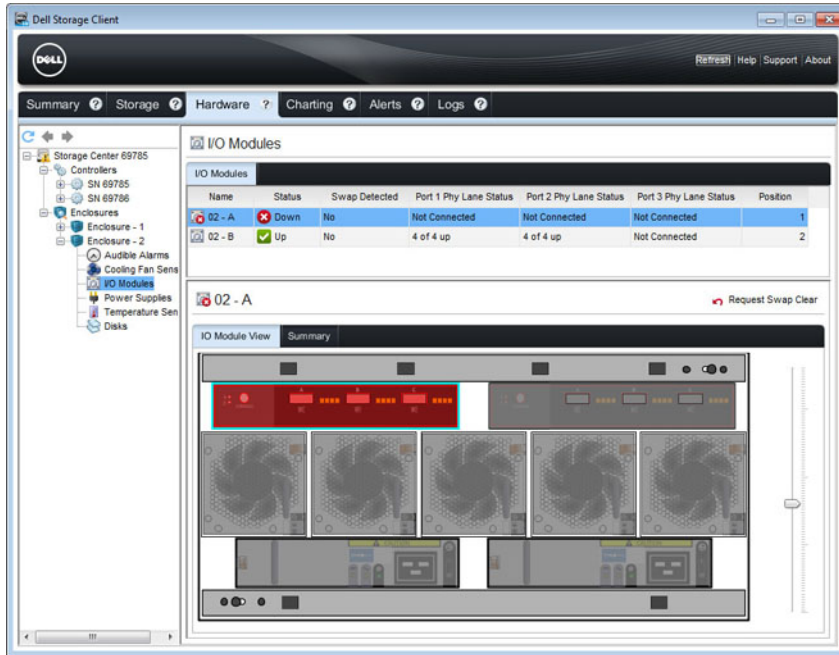

Figure 20. Rear View of the Enclosure Showing the Failed EMM

Replacing an Enclosure Management Module

Use this procedure to replace a failed EMMs.

Prerequisites

1. Use SupportAssist to send diagnostic data to Dell Technical Support Services.

About this task

EMMs can be replaced one at a time without shutting down the storage system.

Steps

1. Disconnect the SAS cables connected to the EMM.

 **NOTE:** Make sure all of the cables are labeled before disconnecting them from the EMM.

2. Push the release tab to the right and pull the release lever away from the chassis.
3. Grasp the release lever and pull the EMM away from the chassis.

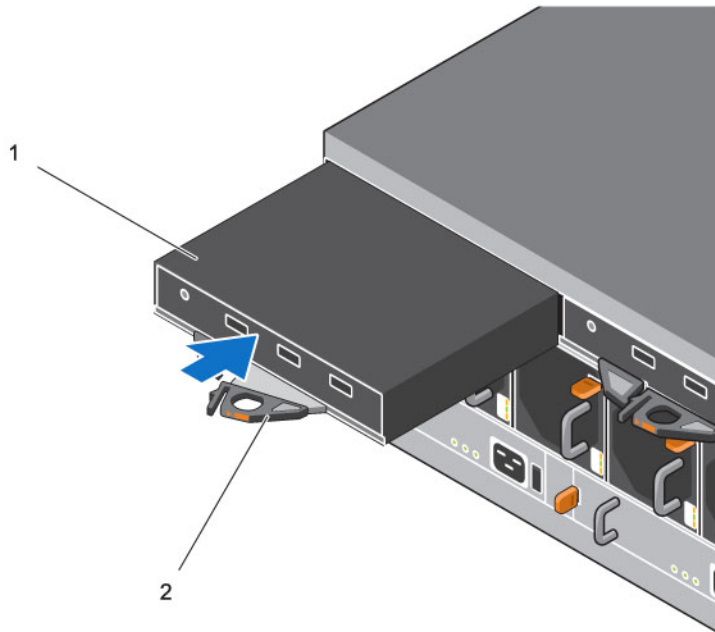

Figure 21. Replacing an EMM

1. EMM

2. EMM release tab and lever

4. Insert the replacement EMM into the bay until it is fully seated.
5. Push the release lever toward the chassis until it clicks into place.
6. Reconnect the SAS cables to the EMM.

Next steps

1. Use SupportAssist to send diagnostic data to Dell Technical Support Services.

Replacing Rack Rails

Rack rails are used to install the SC180 expansion enclosure into a rack.

Prerequisites

1. Use SupportAssist to send diagnostic data to Dell Technical Support Services.
2. Contact Dell Technical Support Services to let them know that you are replacing the rack rails.
3. Shut down the expansion enclosure and expansion enclosure.

About this task

 **NOTE:** Replacing rack rails must be performed during a scheduled maintenance window when the Storage Center system is unavailable to the network.

Steps

1. Remove the Hold Down Brackets (HDBs).

- a. Remove the fixing screws from the rear of the expansion enclosure.
- b. Remove the HDBs from the rear of the rack.
2. Remove the expansion enclosure from the rack rails.



WARNING: Do not attempt to lift the expansion enclosure by yourself. Always get assistance when lifting the expansion enclosure. If installed above the lower 20U of a rack, a customer-provided mechanical lift must be used to avoid injury.

3. Remove the rack rails from the rack.
4. Install the replacement rack rails in the rack.
5. Install the expansion enclosure in the rack rails.
6. Install the HDBs.
7. Start up the storage system and expansion enclosure.

Post-Replacement Procedures

After replacing a component in the SC180 expansion enclosure, start up the SCv2080 storage controllers and the SC180 expansion enclosures if they were previously shut down, then use SupportAssist to send diagnostic data to Dell Technical Support Services.

Start Up the Storage System and Expansion Enclosure

If the storage system and expansion enclosure were previously shut down, perform this procedure to start them up.

1. Plug the power cables into the PSUs of the storage system and expansion enclosure.
2. Turn on the expansion enclosure by pressing the power switches on the PSUs.
 **NOTE:** Always turn on the expansion enclosure before turning on the storage system.
3. Turn on the storage system by pressing the power switches on the PSUs.
4. Use the Dell Storage Client to make sure the replacement part is recognized and shown as up and running.

Sending Diagnostic Data Using Dell SupportAssist

Use Dell SupportAssist to send diagnostic data to Dell Technical Support Services.

1. Click **Send SupportAssist Data Now**. The **Send Support Assist Data Now** dialog box appears.
2. Select **Storage Center Configuration** and **Detailed Logs**.
3. Click **OK**.

Contact Dell Technical Support Services

Contact Dell Technical Support Services to let them know that you completed a repair, and request that they re-enable alerts for the enclosure.

- Ask Dell Technical Support Services for a post-installation system check.

Troubleshooting SC180 Components

This section contains basic troubleshooting steps for components inside the SC180 expansion enclosures.

Troubleshooting Fan Modules

Use these steps to troubleshoot fan modules.

1. Check the status of the fan module using the Dell Storage Client.
2. Determine the status of the fan module LEDs.
If the fan fault indicator is lit, the fan module has failed.
3. Reseat the fan module by removing and reinstalling it.

 **NOTE:** Allow several seconds for the expansion enclosure to recognize the fan module and determine its status.

Troubleshooting PSUs

Use these steps to troubleshoot Power Supply Units (PSUs).

1. Check the status of the PSU using the Dell Storage Client.
2. Determine the status of the PSU LEDs.
 - If the PSU fault indicator is lit, the PSU has failed.
 - If the Power OK LED is not lit, check the power cord and power source into which the power supply is plugged:
 - Connect another device to the power source and check whether the device works.
 - Connect the power cord to a different power source.
 - Replace the power cord.
 - If the AC fault LED is lit, this PSU is not supplying power, though the other PSU may still be supplying power.
3. Reseat the PSU by removing and reinstalling it.

 **NOTE:** Allow several seconds for the expansion enclosure to recognize the PSU and determine its status.

Troubleshooting Disk Drives

Use these steps to troubleshoot disk drives in carriers (DDICs).

1. Check the status of the disk drive using the Dell Storage Client.
2. Determine the status of the DDIC LED.
 - If the DDIC fault LED is lit, the hard drive has failed.

 **CAUTION: Confirm that the particular drive contains no user data. The Fault LED alone is not an indication the drive can be safely removed.**

- If the DDIC fault LED is not lit, proceed to the next step.
3. Check the connectors and reseal the DDIC.

 **CAUTION: Perform this only on unmanaged drives or after you confirm that the particular drive contains no user data. The Fault LED alone is not an indication that you can safely remove the drive.**

- a. Remove the DDIC.
- b. Check the DDIC and the backplane to ensure that the connectors are not damaged.
- c. Reinstall the DDIC. Make sure the DDIC contacts the backplane.

Troubleshooting EMMs

Use these steps to troubleshoot Enclosure Management Modules (EMMs).

1. Check the status of the EMM using the Dell Storage Client.
2. Check the pins and reseal the EMM.
 - a. Remove the EMM.
 - b. Verify that the pins on the backplane and the EMM are not bent. If any pins are bent, do not attempt to correct them, instead, contact Dell Technical Support Services for further instruction.
 - c. Reinstall the EMM.
3. Determine the status of the EMM power and fault LEDs. If the fault LED is lit, the EMM has failed.
4. Verify link status. If the link status LEDs are not green, check the cables.
 - a. Reseat the cables on the expansion enclosure and storage system.
 - b. Recheck the link status LEDs. If the link status LEDs are not green, replace the cables.
5. Reseat the EMM by removing and reinstalling it.

 **NOTE:** Allow several seconds for the expansion enclosure to recognize the EMM and determine its status.

SC180 Technical Specifications

This section contains technical specifications of the SC180 expansion enclosure.

Technical Specifications

The technical specifications of the SC180 expansion enclosure are displayed in the following tables.

Drives	
SAS hard drives	Up to 84 3.5-inch SAS hot-swappable hard drives (6.0 Gbps)
Enclosure Management Modules (EMMs)	
EMMs	Two hot-swappable IO modules
Connectivity	
Configurations	Storage Center supports up to 168 drives on a single redundant-path SAS chain An SCv2080 storage system supports one SC180 expansion enclosure
Redundant Array of Independent Disks (RAID)	
Storage System	SCv2080
Management	RAID management using Dell Storage Client version 2015 R1
Back-Plane Board	
Connectors	<ul style="list-style-type: none"> • 84 SAS hard-drive connectors • Two sets of SBB connectors • Five cooling fan module connectors • Two power supply connectors
Back-Panel Connectors (per EMM)	
SAS connectors	<ul style="list-style-type: none"> • Asymmetric SAS cabling for connecting an expansion enclosure to a storage system. • Supports Mini-SAS HD to Mini-SAS cable universally keyed. The following lengths are currently supported: SCv2080 to SC180: <ul style="list-style-type: none"> – 0.5 m – 2 m

Back-Panel Connectors (per EMM)

- 3 m
- 5 m



NOTE: SAS connectors are SFF-8086/SFF-8088 compliant.

LED Indicators

Front panel	<ul style="list-style-type: none">• One two-digit LCD indicator for Unit ID, error code, and unit location identifier• One two-color LED indicator for power status• One single-color LED indicator for module fault status (expansion enclosure as a whole)• One single-color LED indicator for logical fault status (drive, HBA, RAID controller, and so on)• One single-color LED indicator for drawer 1 fault status• One single-color LED indicator for drawer 2 fault status
Drawer	<ul style="list-style-type: none">• One single-color LED indicator for sideplane card and power status• One single-color LED indicator for drawer fault status• One single-color LED indicator for logical fault status• One single-color LED indicator for cable fault status• Six single-color LED indicators for data transfer status
Disk Drive In Carrier (DDIC)	<ul style="list-style-type: none">• One single-color LED for drive fault status
6 Gb SAS IO module	14 one-color LED status indicators, four each for the three SAS ports and two for the module status
Cooling module	<ul style="list-style-type: none">• One single-color LED indicator for module status• One single-color LED indicator for battery fault status (not currently used)• One single-color LED indicator for fan fault status
Power Supply Unit (PSU)	<ul style="list-style-type: none">• One single-color LED indicator for PSU fault status• One single-color LED indicator for AC power fault status• One single-color LED indicator for power status

Power Supplies

AC power supply (per power supply)

Wattage	2.8 kW
Voltage	200–240 VAC (16 A)
Heat dissipation	191-147 W
Input frequency	50/60 Hz
Max input power	1791 VA
Input current	7.4 A@241 VAC

Power Supplies

Maximum inrush current Under typical line conditions and over the entire system ambient operating range, the inrush current may reach 55 A per power supply for 10 ms or less

Available Hard Drive Power (per Slot)

Supported hard drive power consumption (continuous) Up to 1.16 A at +5 V
Up to 1.6 A at +12 V

IO Card Power (per Slot)

Maximum power consumed by IO Card 11 W at +12 V
Maximum available power 100 W at +12 V
Minimum available power 1 W at +5 V (standby)

Physical

Height 22.23 cm (8.75 inches)
Width 48.26 cm (19 inches)
Depth (front mounting bracket to rear surface) 91.5 cm (36 inches)
Depth (front surface to rear surface) 96 cm (38 inches)
Full Weight (maximum configuration) 130 kg (287 lb)
Weight without drives 62 kg (137 lb)

Environmental



NOTE: For additional information about environmental measurements for specific configurations, see dell.com/environmental_datasheets.

Temperature

Operating 5° to 35°C (41° to 95°F) with a maximum temperature gradation of 10°C per hour



NOTE: Maximum 35°C up to 2134 m (7000 ft), derate to 30°C for 2134 m to 3000 m (7000 ft to 10,000 ft).

Storage -40° to 70°C (-40° to 158°F) with a maximum temperature gradation of 20°C per hour

Relative humidity

Environmental

Operating 20% to 80% (noncondensing) with a maximum humidity gradation of 10% per hour

Storage 5% to 100% (noncondensing)

Maximum vibration

Operating 0.21 G at 5–500 Hz for 15 min

Storage 1.04 G at 2–200 Hz for 15 min

Maximum shock

Operating Half-sine shock 5 G +/- 5% with a pulse duration of 10 ms +/- 10% in operational orientations only

Storage

- Z-axis: 30 g 10 ms half sine
- X- and Y-axes: 20 g 10 ms half sine

Altitude

Operating –30.5 to 3000 m (–100 to 10,000 ft)



NOTE: Maximum 35°C up to 2134 m (7000 ft), derate to 30°C for 2134 m to 3000 m (7000 ft to 10,000 ft).

Storage –300 m to 12,192 m (–1000 ft to 40,000 ft)

Airborne Contaminant Level

Class G2 or lower as defined by ISA-S71.04-1985

Free Manuals Download Website

<http://myh66.com>

<http://usermanuals.us>

<http://www.somanuals.com>

<http://www.4manuals.cc>

<http://www.manual-lib.com>

<http://www.404manual.com>

<http://www.luxmanual.com>

<http://aubethermostatmanual.com>

Golf course search by state

<http://golfingnear.com>

Email search by domain

<http://emailbydomain.com>

Auto manuals search

<http://auto.somanuals.com>

TV manuals search

<http://tv.somanuals.com>