



Delvcam

DELV-TOUCH-10

User Guide



IMPORTANT SAFETY INSTRUCTIONS:

- Please read User Guide before using this product.
- Please keep User Guide for future reference.
- Please read the cautions to prevent possible danger and loss of property.

FEATURES:

- Capacitive touch screen
- 170° Wide viewing angles;
- High resolution: 1280×800;
- Wide voltage: DC 7-24V;
- High contrast: 800:1;
- POP-UP shortcut menu.

CAUTIONS:

1. Please do not place the display screen towards the ground.
2. Please avoid heavy impact or drop onto the ground.
3. Please do NOT use chemical solutions to clean this product. Please wipe with a clean soft cloth to maintain the brightness of the surface.
4. Please do not block any vent hole.
5. Please follow the instructions and trouble-shootings to adjust the product. Other improper adjustment may result in damage. Any further adjustment must be performed or conducted by a qualified technician.
6. Please unplug the power and remove the battery if long-term no-use, or thunder weather.

Contents

| | |
|--|-----------|
| 1. PRODUCT DESCRIPTION..... | 2 |
| 3. INSTALLATION OF SUNSHADE AND BATTERY PLATE | 4 |
| 4. DV BATTERY MOUNT PLATE | 4 |
| 5. WIRING INSTRUCTIONS | 6 |
| 6. MENU SETTING | 6 |
| 7. ACCESSORIES | 12 |
| 8. PARAMETERS | 13 |
| 9. TROUBLE SHOOTING..... | 14 |

1. PRODUCT DESCRIPTION

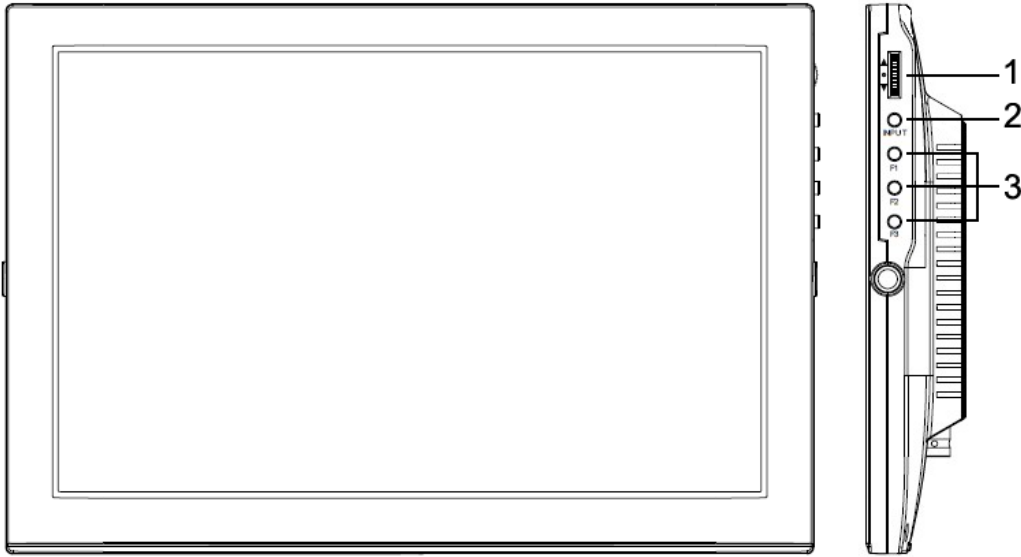

1. Dial: turn up and down to adjust the value of menu option; press to confirm.
2. INPUT: circularly switch among of VIDEO, HDMI, VGA and SDI.
3. F1-F3: User-definable buttons.

Default function:

F1: Waveform F2: Vector F3: Level Meter

(function customized to meet your needs)

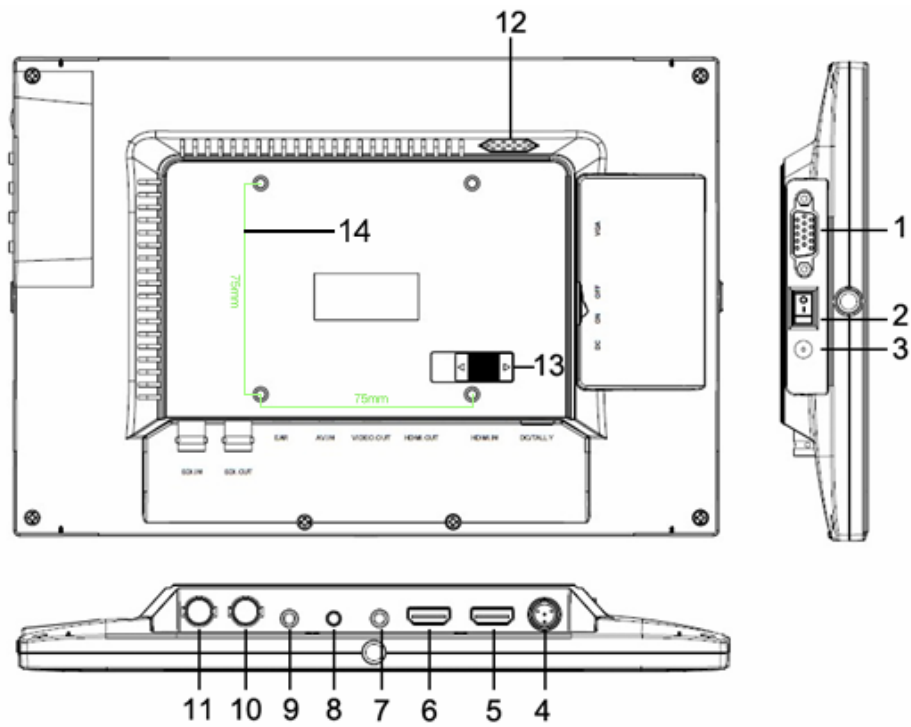

1. VGA interface.
2. Battery power on/off switch: “O” is power off; “I” is power on.
3. DC 12V power input.
4. DC/TALLY connector.
5. HDMI input interface.
6. HDMI output interface **(Optional)**.
7. Video output interface.
8. A / V input interface.
9. Earphone jack.
10. SDI output interface **(Optional)**.
11. SDI input interface **(Optional)**.
12. Speaker
13. Slide to left to connect power cable (connecting with the battery plate).
14. VESA Mounting interface

3. INSTALLATION OF SUNSHADE AND BATTERY PLATE

Installation of sunshade:

- As shown, buckle the upward side of sunshade cover on the device.
- As shown, press the under buckles of sunshade cover at the same time.



- As shown, bend sunshade panel to meet and paste with sunshade interlocking.
- Installation completed.



4. DV BATTERY MOUNT PLATE

Standard mounts process

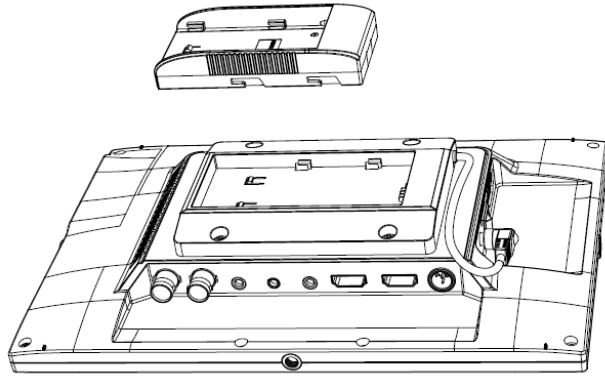

Following three types of battery plates are suitable for this device, model F970, QM91D, DU21 & LP-E6 (choose 2 out of 4).

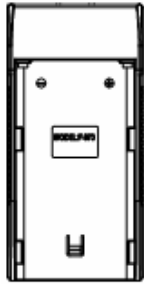

MODEL: F-970

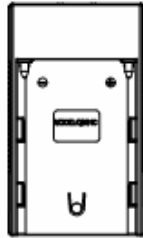

MODEL: QM91D

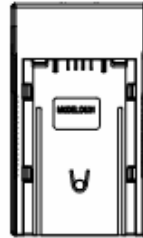

MODEL: DU21



MODEL: LP-E6

DV Battery Mount Plate Specification:

Model DU21 for battery of Panasonic DV: NV-GS/PV-GS/DZ-MV/GS/H28/H258/H288GK series, comply with Panasonic battery DU06/VBD140/SANYO DZhs301sw/Hitachi DZ-HS303SW/BZ-BP14S/DZ3200/BP07W.

Model QM91D for battery of SONY DV:

DSCR1/F/S/MVCCD/E/HC15E/HC1E/AE1u/DCRTRV828/E/CCD-TRV116/DCR-DVD/PS105 K/300K/10P/1E series.

Model F970 for battery of SONY DV: DCR-TRV series, DCR-TRV E series, VX2100E PD P series, GV-A700, GV-D800 FD/CCD-SC/TR3/FX1E/HVR-AIC, HDR-FX1000E, HVR-Z1C, HVR-V1C, FX7E F330.

Model LP-E6 for battery of Canon DSLR: 5D Mark II/5D Mark III/EOS7D/EOS60D;

V-mount battery plate (optional): Please refer to GP-L130AB type battery specifications.

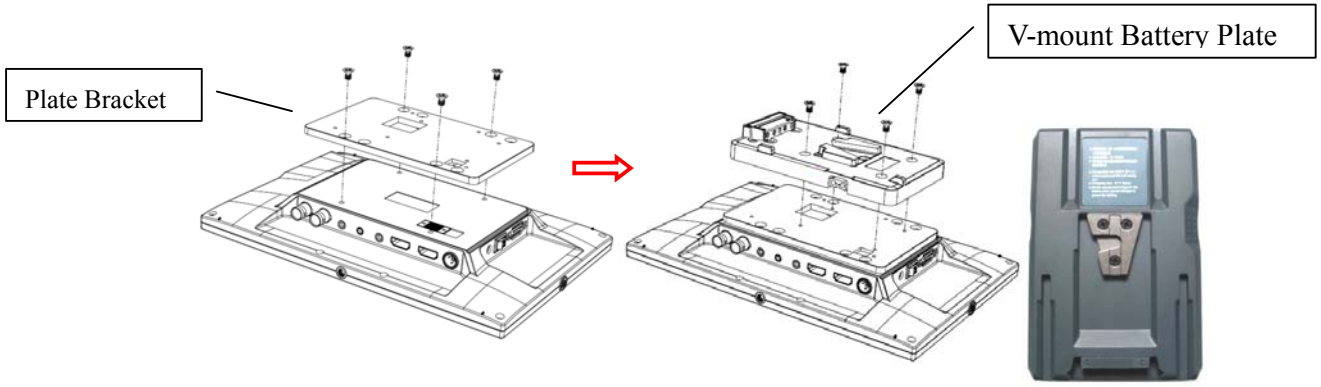

Anton Bauer mount battery plate (optional):

GP-L130AB

Please refer to GP-L130B type battery specifications.

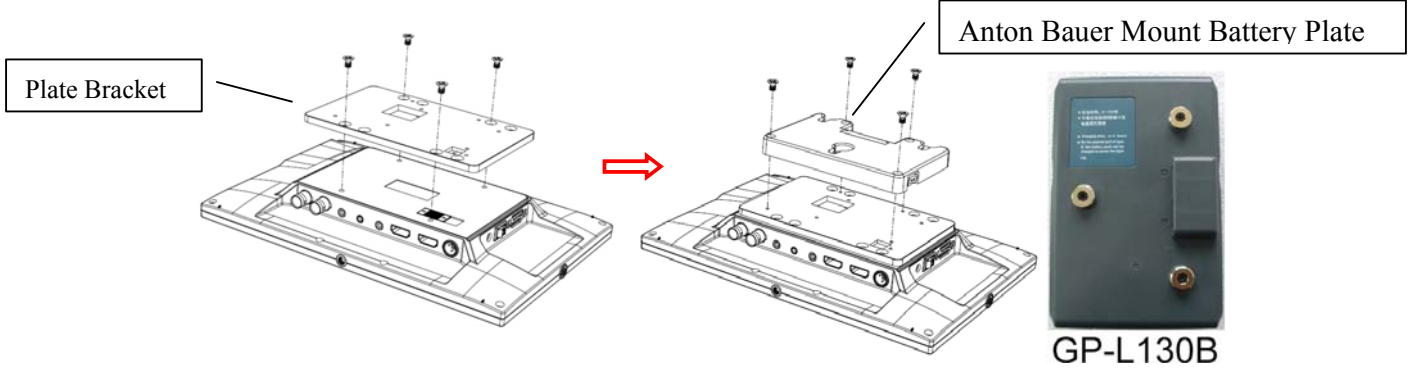

5. WIRING INSTRUCTIONS

Composite cable

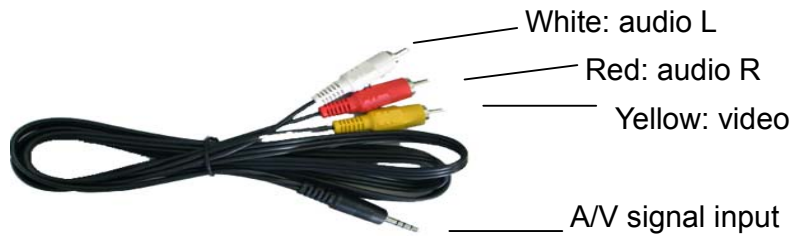

6. MENU SETTING

Before setting the functions, please make sure the device is connected correctly.

6-1. Touch Control Gesture

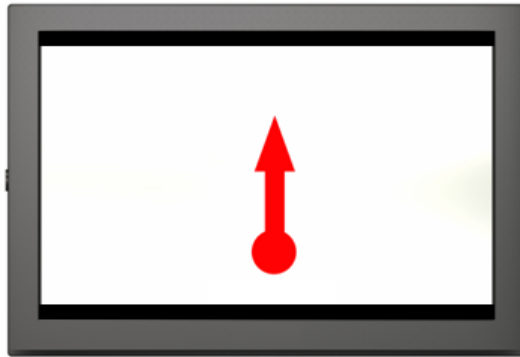

Swipe up to activate the shortcut menu.

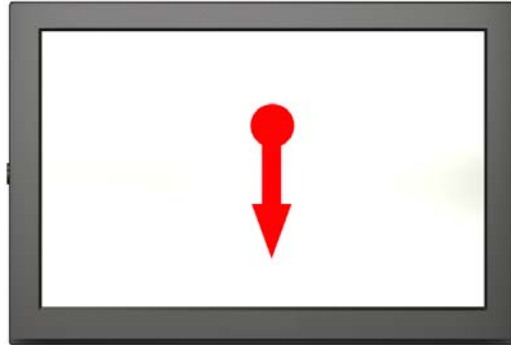

Swipe down to hide the shortcut menu. (Unable to hide the shortcut menu without signal input.)

6-2. F1-F3 3 user-definable function buttons:

Long press any F1-F3 key for 3-5 seconds to pop-up shortcut menu directly. As shown in Figure (default menu button in blue font).

Slide up and down to select the desired option.

Finally, press the slider to confirm the selected item as default.

Functions of FN button can also be customized: Center Marker, Screen Marker, Check Field, Color Bar, Aspect Ratio, Camera, PIP, Zoom, Pixel-to-Pixel, Freeze Input, Underscan, H/V Delay, Peaking, False Color, Exposure, Histogram, Level Meter, Waveform, Vector.

FN: user-definable function button.

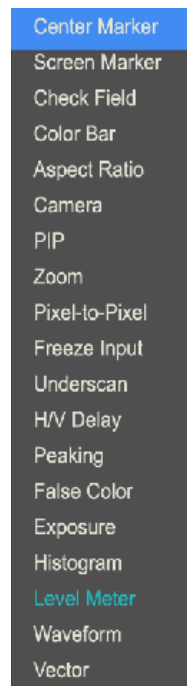

Default function:

F1: Waveform

F2: Vector

F3: Level Meter

6-3. Dial Operation

Turn down the dial to activate Brightness adjustment.



Turn up and down to adjust the value directly.

Press the dial to activate options switch among of "Brightness, Contrast,

Saturation, Sharpness, Hue, Volume and Exit”. (Option adjusted currently will be default option when user press the dial next time.)

6-4. MENU Operation

6-4-1、Shortcut Menu Bar

Swipe up on the display screen to activate shortcut menu, select the option needs to adjust on the menu bar. (Top menu bar: option values all shown on screen when click; Bottom menu bar: option values shown individually on screen when click.)

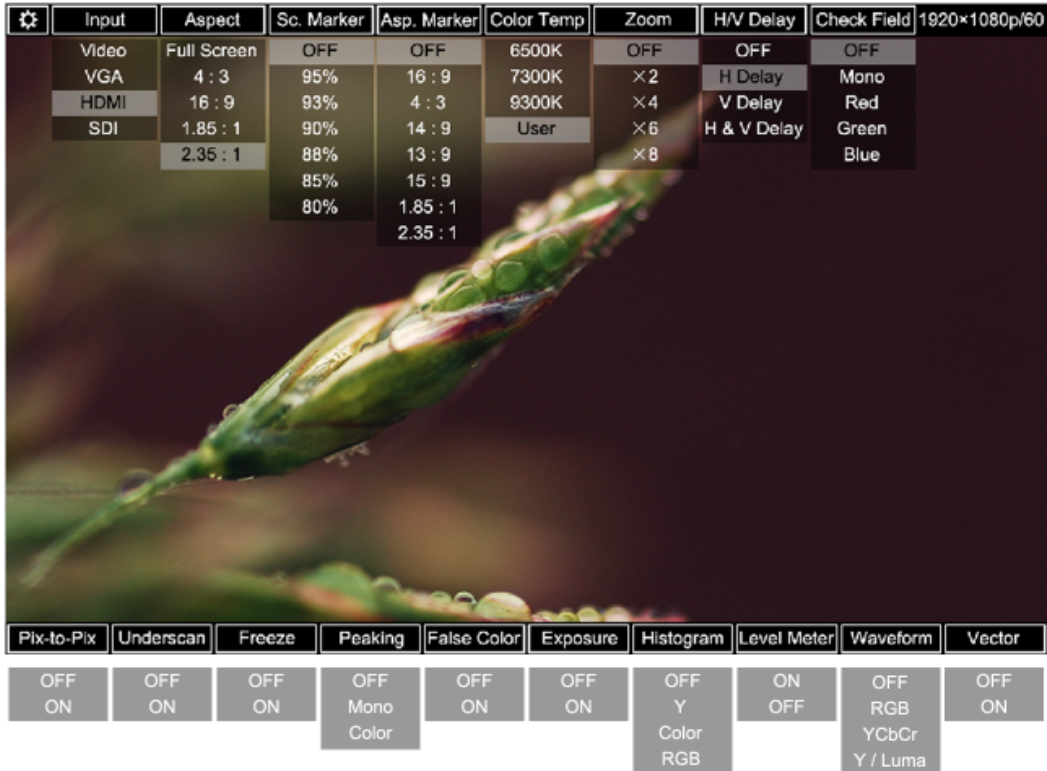

6-4-2. Clock””, enter the menu options

“” is return, “” is exit.

Main interface



□ **Picture**

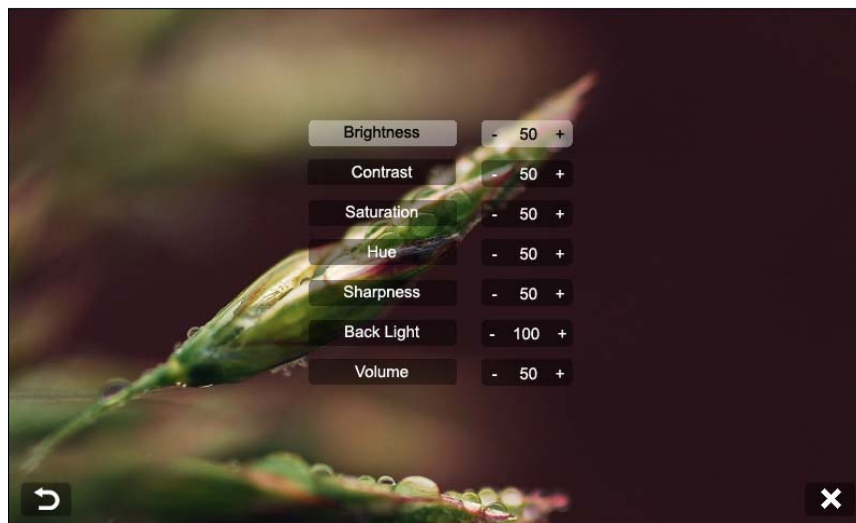

| ITEMS | OPTIONS |
|------------|---------|
| Brightness | 0 – 100 |
| Contrast | 0 – 100 |
| Saturation | 0 – 100 |
| Hue | 0 – 100 |
| Sharpness | 0 – 100 |
| Back light | 0 – 100 |
| Volume | 0 – 100 |

□ **Display**

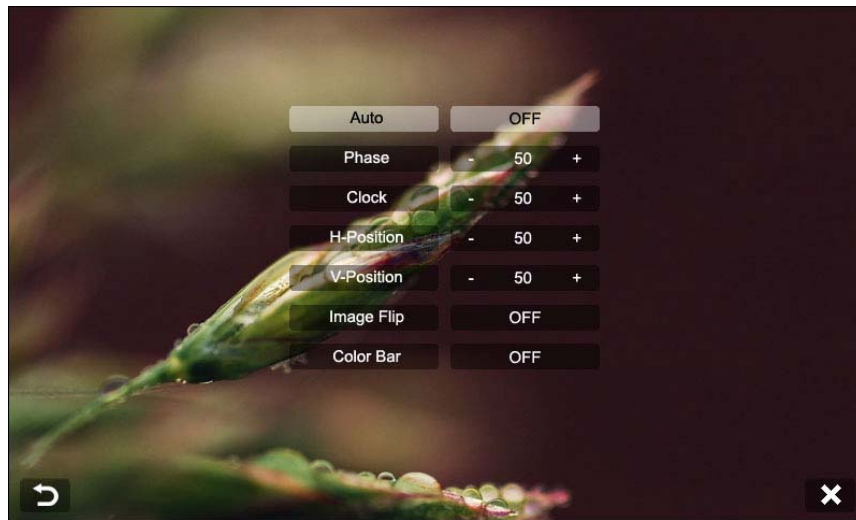

| ITEMS | OPTIONS | |
|------------|---------|-------------------------|
| Auto | OFF, ON | Options under VGA mode. |
| Phase | 0 – 63 | |
| Clock | 0 – 100 | |
| H-Position | 0 – 100 | |
| V-Position | 0 – 100 | |
| Image Flip | OFF, ON | |
| Color Bar | OFF, ON | |

□ **Color Temp**

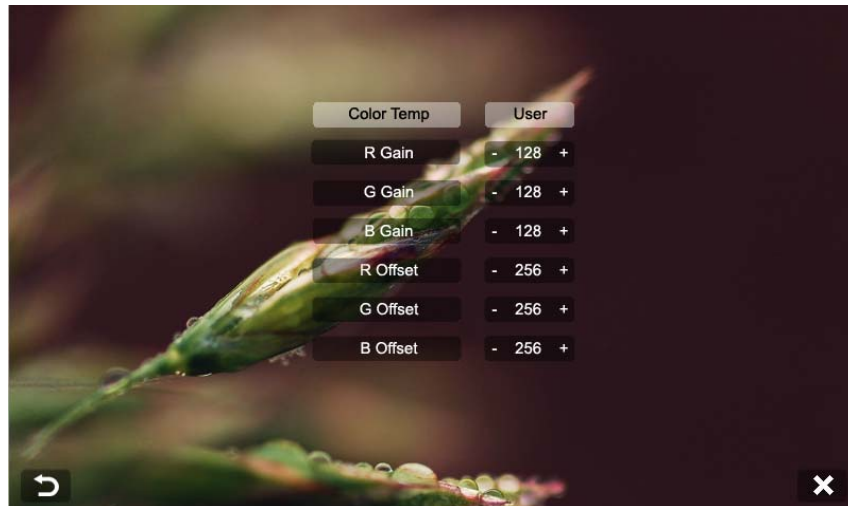

| ITEMS | | OPTIONS |
|------------|---------|--|
| Color Temp | | 6500K/ 7300K/ 9300K/ User |
| R Gain | 0 ~ 255 | Note: Only available under “User” mode to meet the color value you need. |
| G Gain | 0 ~ 255 | |
| B Gain | 0 ~ 255 | |
| R Offset | 0 ~ 511 | |
| G Offset | 0 ~ 511 | |
| B Offset | 0 ~ 511 | |

□、Marker

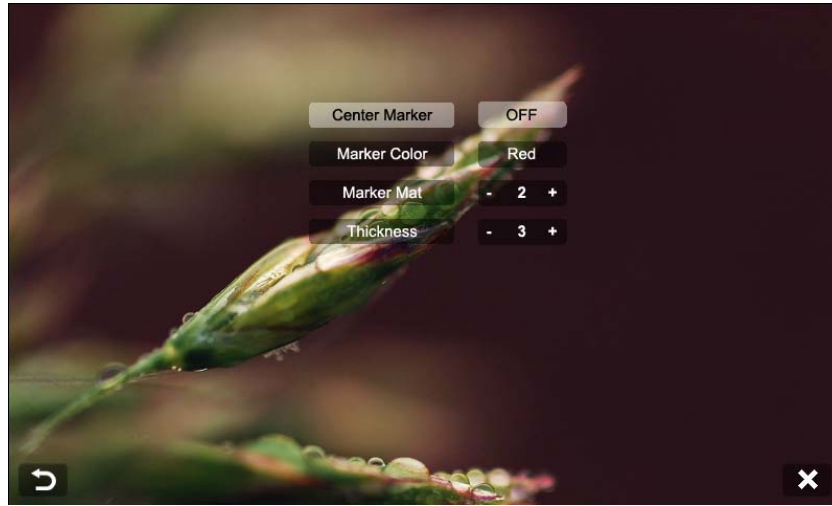

| ITEMS | OPTIONS |
|---------------|--------------------------------|
| Center Marker | OFF, ON |
| Marker Color | Red, Green, Blue, White, Black |
| Marker Mat | 0 – 7 |
| Thickness | 1 – 8 |

□ PIP



| ITEMS | OPTIONS |
|--------------|--|
| PIP Mode | Small, Medium, Large, PBP, POP |
| PIP Source | Video, VGA , HDMI and SDI (SDI is optional) |
| PIP position | Upper Left, Upper Right, Lower Left, Lower Right |
| PIP Swap | Signal adjust & switch under PBP and POP modes. |

□ Setting

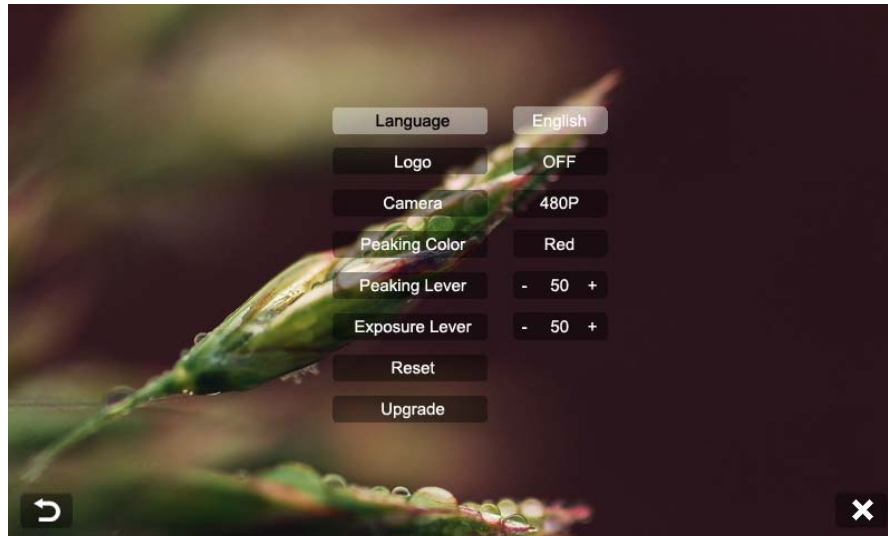

| ITEMS | OPTIONS |
|----------------|---------------------------------------|
| Language | English, Chinese |
| LOGO | ON, OFF |
| Camera | 480P (5DII Mode) / 1080I (5DIII Mode) |
| Peaking Color | Red, Green, Blue, White, Black |
| Peaking Lever | 0 – 100 |
| Exposure Lever | 0 – 100 |
| Reset | |
| Upgrade | |

7. ACCESSORIES

Standard Accessories:

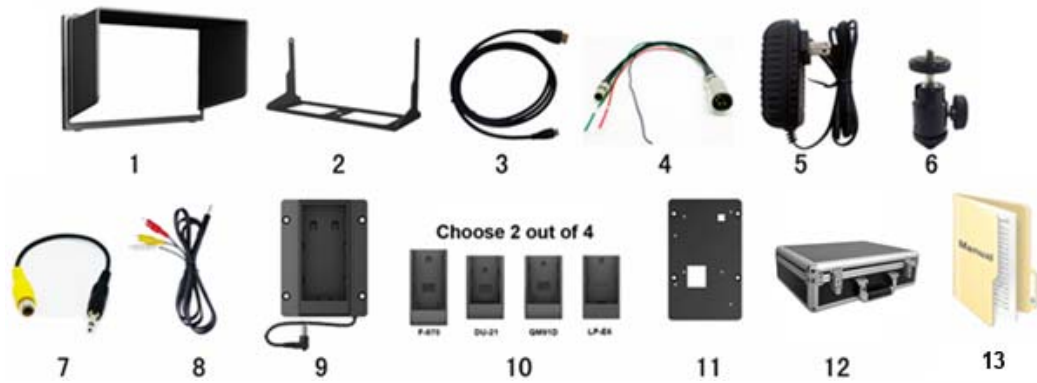

- | | |
|--|------------------------------|
| 1. Sun Shade Cover | 1 Piece |
| 2. Gimbal bracket | 1 Piece |
| 3. HDMI A/C cable | 1 Piece |
| 4. Mini XLR & TALLY cable | 1 Piece |
| 5. 12V DC adapter | 1 Piece |
| 6. Shoe Mount (for camera only) | 1 Piece |
| 7. Audio output cable | 1 Piece |
| 8. Composite cable | 1 Piece |
| 9. VESA Adaptor Panel | 1 Piece |
| 10. Battery Plate (F-970/QM91D/DU21/LP-E6) | 2 Pieces (Choose 2 out of 4) |
| 11. Adaptor Panel | 1 Piece |
| 12. Suitcase | 1 piece |
| 13. Manual | 1 Copy |

Optional Accessories

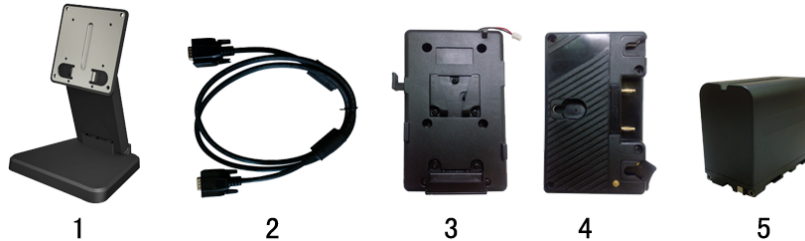

- | | |
|------------------------------------|---------|
| 1. VESA folding bracket | 1 Piece |
| 2. VGA cable | 1 Piece |
| 3. V-mount Battery Plate | 1Piece |
| 4. Anton Bauer Mount Battery Plate | 1Piece |
| 5. Li-ion Battery | 1Piece |

8. PARAMETERS

9. TROUBLE SHOOTING

1. Only black-and-white display:

Check whether the color saturation is properly setup or not.

2. Power on but no pictures:

Check whether the cables of AV, VGA, HDMI and SDI are correctly connected or not.

| | |
|-----------------------|---|
| Panel | 10.1" LED Back light |
| Physical Resolution | 1280×800 |
| Brightness | 350cd/m ² |
| Contrast | 800: 1 |
| Viewing Angle | 170°/ 170°(H/V) |
| Input Voltage | DC 7-24V |
| Input Signal | AV, HDMI, VGA and SDI (SDI is optional) |
| Power Consumption | ≤ 10W |
| Operating Temperature | -0℃~50℃ |
| Storage Temperature | -20℃~60℃ |
| Dimension (LWD) | 250×170×29.6mm |
| Weight | 735g |

Please use the standard power adapter coming with the product package. Improper power input may cause damage.

3. Wrong or abnormal colors:

Check whether the cables are correctly and properly connected or not. Broken or loose pins of the cables may cause a bad connection.

4. When on the picture shows size error:

Swipe up to activate menu, Click "Underscan" to zoom in/out pictures automatically when receiving HDMI signals

5. Other problems:

Swipe up to activate menu, Click  → Setting → Reset "

6. According to the ISP, the machine can not function properly:

ISP for program upgrades, non-professionals do not use. Please reboot your device if press accidentally!

· It is normal to see some bright lines appear on the screen when turn off the device.

Note: due to constant effort to improve products and product features, specifications may change without notice.

Free Manuals Download Website

<http://myh66.com>

<http://usermanuals.us>

<http://www.somanuals.com>

<http://www.4manuals.cc>

<http://www.manual-lib.com>

<http://www.404manual.com>

<http://www.luxmanual.com>

<http://aubethermostatmanual.com>

Golf course search by state

<http://golfingnear.com>

Email search by domain

<http://emailbydomain.com>

Auto manuals search

<http://auto.somanuals.com>

TV manuals search

<http://tv.somanuals.com>