

**Package contents**

- Blu-ray disc player
- AAA batteries (2)
- Remote control
- User Guide
- Quick Setup Guide

**Installing remote control batteries**

1 Remove the battery compartment cover.

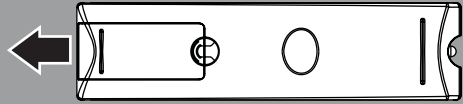

2 Insert two AAA batteries into the battery compartment. Make sure that the + and - symbols on the batteries match the + and - symbols in the battery compartment.

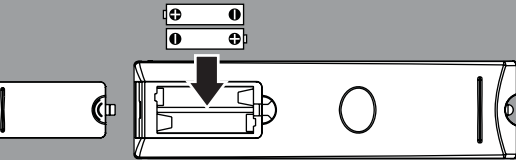

3 Replace the battery compartment cover.

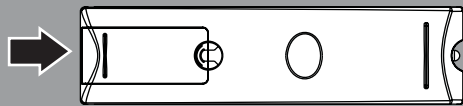

For the most updated User Guide, please visit [www.dynexproducts.com](http://www.dynexproducts.com)

**Connecting a TV**

Using HDMI (best)

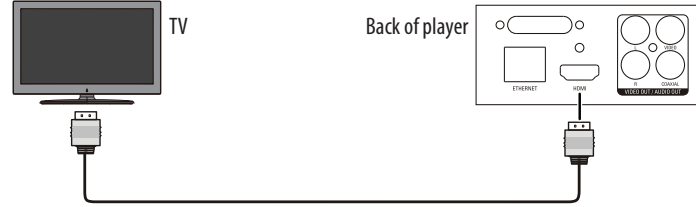

Using an AV cable

**Note:** The AV cable can only send standard-definition video (480i) to your TV.

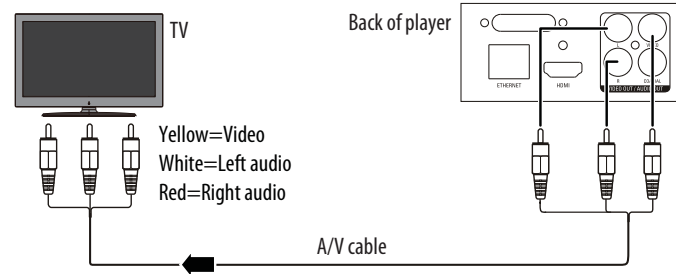

To connect to a home theater, see your User Guide.

**Plugging in your DVD player and turning it on**

- 1 Plug the power cord into a standard power outlet.
- 2 Press the (standby/on) button on your DVD player or the STANDBY/ON button on the remote control.

**Connecting to your home network**

This player can be connected to your wired network using the Ethernet port on the back of your player or using a wireless network. Using a wired network provides the best performance, because the attached devices connect directly to the network and avoid interference from other wireless devices.

There are two types of wireless network connections:

- Select a network from a list of available networks
- Use WIFI protected setup

**Connecting to the Internet with a wireless network:**

- 1 Set up your access point or wireless router (if not already set up).
- 2 Press **ENTER**. The Settings menu opens.

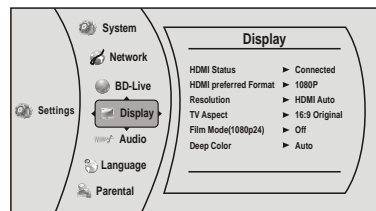

3 Press **▲** or **▼** to select **Network**, then press **ENTER**.

4 The Wireless screen opens.

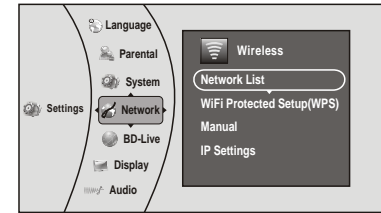

5 Press **ENTER**. The Network List screen opens showing a list of available wireless networks.

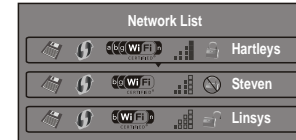

- 6 Press **▲** or **▼** to select the wireless network you want your player to connect to, then press **ENTER**. A Network Setup screen opens with the following options:
  - **Connect**—Connect to this network.
  - **WPS Pin**—Create a random PIN number password.
  - **Cancel**—Go back to Network List.
- 7 If your network does not use encryption, press **▲** or **▼** to select **Connect**, then press **ENTER**. If the wireless network is working, you should see a checkmark and a connected message on the TV. If the message does not appear, repeat the steps above.

OR

If your network uses encryption:

- a Press **▲** or **▼** to select the **Password** field, then press **ENTER**. An on-screen keyboard opens.
- b Press **▲**, **▼**, **◀**, or **▶** to select the first letter in the password, then press **ENTER**. Repeat this step to enter the rest of the password. If you make a mistake, use the **Clear** key to delete the character.
- c After you enter the password, select the red “Done” in the upper left-hand corner of the keyboard, then press **ENTER** to close the keyboard.
- d Press **▲** or **▼** to select **Connect**, then press **ENTER**. A connection message appears. Select **Close**, then press **ENTER**. If the connection is not successful, repeat the steps above.
- e Press **◀** to go to the previous menu.

**Setting up WiFi protection (WPS)**

- 1 Press **ENTER**. The Settings menu opens.
- 2 Press **▲** or **▼** to select **Network**.

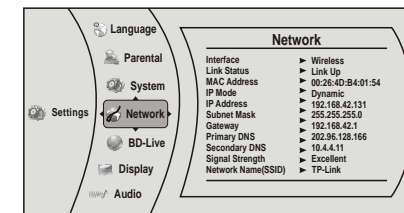

3 Press **▶**, then press **▼** to select **WiFi Protected Setup (WPS)**, then press **ENTER**. A screen appears, asking you to press the button on your router.

- Press the button on top of your router. A screen should appear on your TV that says "Success" when your player is connected to the router. Press **ENTER** to close the message.

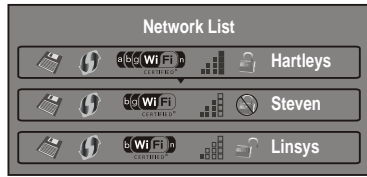

- Press **◀** to go to the previous menu.

### Connecting to the Internet with a wired network:

- Connect a network cable to the **INTERNET** jack on the back of your player and into a wired router using a commercially available LAN or Ethernet cable.

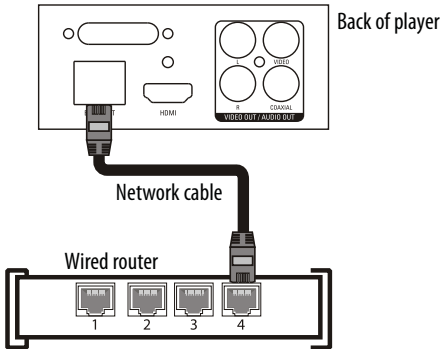

- Press **ENTER**. The *Settings* menu opens.
- Select **Network**.

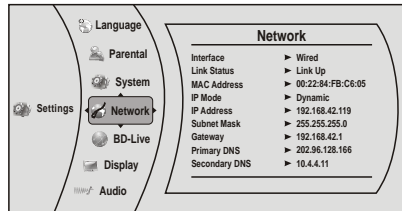

- If the network connection is active, **Link Up** appears next to **Link Status**. If the network connection is not active, **Link Down** appears next to **Link Status**.

- Press **ENTER**, select *IP Mode*, then press **ENTER**.

- Press **▲** or **▼** to select an *IP Mode*. You can select:

- Dynamic** - Uses DHCP to automatically obtain an IP address.
- Manual** - Lets you manually configure network settings. (See your *User Guide* to set up your connection manually.)



- Press **◀** to go to the previous menu.

**Advanced users only:** To make changes to your network connection, see your *User Guide*.

## Testing your network connection

- Press **ENTER**. The *Settings* menu opens.
- Press **▲** or **▼** to select **Network**, then press **ENTER**.
- Press **▲** or **▼** to select **Network Test**, then press **ENTER**.

The Network Test begins and runs three tests:

- Local Network Test.** If this test fails, check the connection to your home network.
  - If you have a wired connection:**
    - \* Make sure your network cable is securely attached to your router and your player.
    - \* Make sure your router is connected to your cable or DSL modem correctly.
  - If you have a wireless connection:**
    - \* Make sure your router is connected to your cable or DSL modem correctly.
    - \* Make sure your player is within the range of your router.
    - \* Make sure the desired WIFI network is selected.
    - \* If you have a security password, be sure you have entered the password correctly.
    - \* If further help is needed for setting up security and obtaining your security password, contact your router manufacturer and/or cable or DSL modem manufacturer.

- DNS Server Test.** If this test fails, there may be an issue with your Internet service provider.

- Make sure your router is connected to your cable or DSL modem correctly.
- Contact your Internet service provider for more help.

- Internet Connection Test.** If this test fails, there may be an issue with your Internet service provider.

- Make sure your router is connected to your cable or DSL modem correctly.
- Contact your Internet service provider for more help.

## Using connected applications

You can watch movies over the Internet (for example, from Netflix or CinemaNow), or to listen to Pandora Internet radio. Before being able to use these Internet services, you must first:

- Have connected the player to the Internet, and passed the Network Test.
- Have a valid account to these services.

### Watching movies with Netflix (Application available in US & Canada)

- Select **Netflix** to register the player with your Netflix account. Follow the directions on the screen. You will be provided with an activation code.
- If you already have an existing Netflix account, log in to your account on your PC. Click on the **Your Account & Help** link in the upper-right corner of the screen.
- In the **WATCHING INSTANTLY ON YOUR TV OR COMPUTER** section, click **Activate a Netflix Ready Device** and enter the activation code from Step 1. - OR -

If you do not have an existing Netflix account, go to <http://www.netflix.com/Dynex> (US) or <http://www.netflix.ca/Dynex> (Canada) to start your free trial and enter the activation code from Step 1 into the **Dynex code** field on the screen.

- After setting up your account and activating your Blu-ray player, browse to **Instant** under the **Your Queue** tab and add movies to your queue.
- To exit Netflix, press **⏏/Setup**.

### Watching movies with CinemaNow (Application available in US)

- First set up your CinemaNow account through your PC. Go to [www.cinemanow.com/activate](http://www.cinemanow.com/activate) to get an activation PIN.
- Log in to CinemaNow with your account information and password.
- Browse to **Activate/Deactivate** under the **My Account** section.
- Click on **Activate a New Device** and sign in again with your user name/password.
- Enter any name in the **Name Your Device** section, then click **Continue**. You are provided with a valid activation number to enter into the activation field within the Cinemanow application on your Blu-ray player.
- After you have successfully established an Internet connection on your Blu-ray player, select the **Cinemanow** application using your remote control, then press **ENTER**.
- Select the **Settings** tab at the bottom of the screen, then press **ENTER**.
- Select **Activate** and enter your activation code. You can now rent movies using Cinemanow.
- To exit CinemaNow, press **⏏/Setup**.

### Listening to music with Pandora (Application available in US)

To use an existing Pandora account:

- Press **▲** or **▼** to select **Pandora**, then press **ENTER**.
- Select **I have a Pandora account** from the options, then sign in with your account information.

To create a new Pandora account on your player:

- Select **Pandora**.
- Select **I am new to Pandora** from the options. You will receive an activation code.
- On your PC, go to [www.pandora.com/dynex](http://www.pandora.com/dynex) and enter the activation code from Step 2, then click **Activate**.
- Click **Create a Pandora Account** and follow the on-screen instructions.
- To exit Pandora, press **Home/Setup**.

To create a new Pandora account using a PC:

- Go to <http://www.pandora.com/> to create a new account.

Contact the partner company (not Dynex) if you experience an issue using one of these applications.

**Note:** Support numbers for the connected applications apply to the US market only.

#### Netflix:

[www.netflix.com/help](http://www.netflix.com/help)  
1-866-579-7113

#### CinemaNow:

[www.cinemanow.com/support](http://www.cinemanow.com/support)

#### Pandora:

<http://blog.pandora.com/faq/>

## Using connected applications

To stay up-to-date on future service options, visit [www.dynexproducts.com](http://www.dynexproducts.com).

## One-year limited warranty

Visit [www.dynexproducts.com](http://www.dynexproducts.com) for details.

## Contact Dynex:

For customer service, call 800-305-2204  
[www.dynexproducts.com](http://www.dynexproducts.com)

© 2012 BBY Solutions, Inc. All Rights Reserved. DYNEX is a trademark of BBY Solutions, Inc. Registered in some countries. All other products and brand names are trademarks of their respective owners.

## Free Manuals Download Website

<http://myh66.com>

<http://usermanuals.us>

<http://www.somanuals.com>

<http://www.4manuals.cc>

<http://www.manual-lib.com>

<http://www.404manual.com>

<http://www.luxmanual.com>

<http://aubethermostatmanual.com>

Golf course search by state

<http://golfingnear.com>

Email search by domain

<http://emailbydomain.com>

Auto manuals search

<http://auto.somanuals.com>

TV manuals search

<http://tv.somanuals.com>