

EASY-KLEEN

PRESSURE SYSTEMS LTD.
MANUFACTURER OF HIGH PRESSURE CLEANING EQUIPMENT

Commercial and Industrial Cold Water Electric

OWNER'S MANUAL



Call 1-800-315-5533

Email sales@easykleen.com

Website: www.easykleen.com

Easy-Kleen Pressure Systems

1-800-315-5533

This manual contains operational information that is specific for commercial and industrial cold water, electric driven machines.

Read the following instructions carefully before attempting to assemble, install, operate or service this pressure washer. Failure to comply with these instructions could result in personal injury and/or property damage.

Table of Contents

IMPORTANT SAFETY INFORMATION	3
SPECIFICATIONS.....	6
INTRODUCTION	7
OPERATING INSTRUCTIONS	8
CHEMICAL APPLICATION	9
WINTER PUMP PROTECTION	10
GENERAL MAINTENANCE.....	10
MAINTENANCE CHECKLIST	11
GLOSSARY OF TERMS	12
COMPONENT IDENTIFICATION.....	13
QUICK DIAGNOSTICS AND SOLUTIONS GUIDE.....	20
MANUFACTURER’S WARRANTY	21
CIRCUIT DIAGRAMS	22
SERVICE MANUAL	27

IMPORTANT SAFETY INFORMATION

The safe operation of our pressure washing systems is the **FIRST** priority of Easy-Kleen. This will only be achieved by following the operation and maintenance instructions as explained in this manual and all other enclosed manuals.

This manual contains essential information regarding the safety hazards, operations, and maintenance associated with this machine. The manual should always remain with the machine, including if it is resold.

ALL CAUTIONS AND SAFETY WARNINGS MUST BE FOLLOWED TO AVOID INJURY OR DAMAGE TO EQUIPMENT.

THIS EQUIPMENT IS TO BE USED ONLY BY TRAINED OPERATORS AND MUST ALWAYS BE ATTENDED DURING OPERATION.



WARNING: To reduce the risk of injury, read operating instructions carefully before using.

1. Read the instructions in this manual carefully before attempting to assemble, install, operate or service this pressure washer. Failure to comply with the instructions could result in personal injury and/or property damage.



WARNING: Use protective eyewear and clothing when operating equipment in order to avoid personal injuries.



WARNING: This machine exceeds 85db. Appropriate ear protection must be worn.



WARNING: Trigger gun kicks back. Hold with both hands.

2. Hold firmly to the gun and wand during start up and operation of the machine. Do not attempt to make adjustments while the trigger gun is in operation.

3. Make sure all quick coupler fittings are properly secured before operating pressure washer.



WARNING: Keep water spray away from electrical wiring.

4. All electrically powered equipment must be grounded at all times to prevent fatal electric shots. Do not spray water on or near electrical components. Do not touch electrical components while standing in water or when hands are wet. Always make sure machine is disconnected from power source before servicing.



WARNING: Risk of injection or severe injury to persons. Keep clear of nozzle spray.

5. High pressure spray can cause serious injuries. Never point pressurized spray at any person or animal. Handle the spray assembly with care.



WARNING: Risk of injury from falls when using ladder.

6. Do not overreach or stand on anything unstable. Keep a good balance and make sure to keep a steady footing at all times.



WARNING: Protect from freezing.

7. It is important to keep your machine from freezing in order to keep it in its best working condition. Failure to protect your machine from freezing may cause damage to the machine and personal injuries may occur as a result.

8. WARNING: Keep hands clear from belt guard and other moving parts. DO NOT OPERATE MACHINE WITH BELT GUARD REMOVED.

9. Protect high pressure hoses from sharp objects and vehicles. Inspect condition of hoses prior to use, or serious injury could occur.

10. Do not pass acids or other caustic or abrasive fluids through the pump.

11. Do not attempt to operate this machine if fatigued or under the influence of alcohol, prescription medications, or drugs.

12. Some of the maintenance procedures involved in this machine require a certified technician (these steps are indicated throughout this manual). Do not attempt to perform these repairs if you are not qualified.

If you need further explanation of any of the information in this manual, suspend any activity involving the equipment and call our toll free number for assistance, 1-800-315-5533.

SPECIFICATIONS

Commercial Cold Water Electric				
MODEL	GPM	PSI	DRIVE RPM	HP/VOLTAGE
AS152E Alternate Spec	2.2	1500 1000	1750	2/110/1ph 15 Amps
AS2436E	3.6	2400	1750	5/220/1ph
AS253E-GP	3.5	2400	1750	5/220/1ph
AS304E	4	3000	1750	7.5/220/1ph
AS3636E	3.6	3600	1750	7.5/220/1ph
AS3035E-GP	3.5	3000	1750	7.5/220/1ph

Industrial Cold Water Electric					
MODEL	GPM	PSI	DRIVE	HP	VOLTAGE
IS204FE-1	4	2000	FLANGE/COUPLING	5	220V 1ph
IS204FE-3	4	2000	FLANGE/COUPLING	5	208/440/575V3ph
IS204E-1	4	2000	BELT	5	220V 1ph
IS204E-3	4	2000	BELT	5	208/440/575V 3ph
IS304FE-1	4	3000	FLANGE/COUPLING	7.5	220V 1ph
IS304FE-3	4	3000	FLANGE/COUPLING	7.5	208/440/575V 3ph
IS304E-1	4	3000	BELT	7.5	220V 1ph
IS304E-3	4	3000	BELT	7.5	208/440/575V 3ph
IS255FE-3	5	2500	FLANGE/COUPLING	7.5	208/440/575V 3ph
IS208E-3	8	2000	BELT	10	208/440/575V 3ph
IS306E-1	5.5	3000	BELT	10	220V 1ph
IS306E-3	5.5	3000	BELT	10	208/440/575V 3ph
IS404FE-1	4	4000	FLANGE/COUPLING	10	220V 1ph
IS404FE-3	4	4000	FLANGE/COUPLING	10	208/440/575V 3ph
IS1212E-3	12	1200	BELT	10	208/440/575V 3ph
IS3606E-3	6	3600	BELT	15	208/440/575V 3ph
IS465E-3	6.5	4000	BELT	20	208/440/575V 3ph
IS505E-3	5	5000	BELT	20	208/440/575V 3ph
IS310E-3	10	3000	BELT	20	208/440/575V 3ph
IS2512E-3	12	2500	BELT	20	208/440/575V 3ph
IS3685E-3	8.5	3600	BELT	20	208/440/575V 3ph
IS654E-3	4.3	6500	BELT	20	208/440/575V 3ph
IS704E-3	4	7000	BELT	20	208/440/575V 3ph
IS808E-3	8	8000	BELT	50	208/440/575V 3ph

Firehouse & Car Detailing Series					
MODEL	GPM	PSI	DRIVE	HP	VOLTAGE
FD2040E	4	2000	DIRECT DRIVE	5	230V-1PH
FD3035E-GP	3.5	3000	DIRECT DRIVE	7.5	230V-1PH
FD2435E-GP	3.5	2400	DIRECT DRIVE	5	230V-1PH

INTRODUCTION

Thank you for selecting a quality Easy-Kleen product. We are pleased to have you included among the many satisfied owners of Easy-Kleen cleaning machines. Years of engineering have gone into the development of these fine products and only top quality components and materials are used throughout. Each machine is carefully tested and inspected before leaving our plant to ensure years of dependable performance.

To continue to receive satisfactory performance, remembering that this machine represents a substantial investment on your part, and if properly cared for and maintained it will return this investment many times over. As with all mechanical equipment, your machine requires proper operation and maintenance as outlined in this manual for maximum trouble free life.

This manual has been prepared under the direction of our engineering and service technicians. Their experience in designing, manufacturing, installing and servicing our equipment from our company's inception is condensed in this manual. They know what information the end user needs in order to get the optimum performance from their pressure washer. Please read carefully.

This manual contains information that will be specific for your pressure washer, as well as similar models.

Carefully review any additional manuals that have been included with your system and follow **ALL ADDITIONAL OPERATING INSTRUCTIONS AND SAFETY NOTICES**. They are specific for the quality components that have been used to manufacture your machine and are an integral part of the operating and maintenance procedures.

The management & staff at Easy-Kleen are proud of the equipment that we design and manufacture, and we thank you for making us your # 1 choice in pressure washers. If you have any questions please do not hesitate to call us, 1-800-315-5533.

Our goal is that you will be satisfied with the performance, quality, and service you receive from Easy Kleen and that if you need to replace this machine in years to come, you will give us the opportunity to continue supplying equipment to your company.

PLEASE READ MANUALS CAREFULLY BEFORE USING MACHINE. EXAMINE MACHINE AND CRATE CAREFULLY FOR SHIPPING DAMAGE OR MISSING PARTS. REPORT PROMPTLY ANY SHORTAGES OR DAMAGE CLAIMS TO FREIGHT CARRIER OR DEALER.

OPERATING INSTRUCTIONS

1. **Perform pre-start maintenance** inspection on all applicable systems prior to operating the machine. This is essential for the safe, effective and efficient operation. You will get optimum performance from your system ONLY if these instructions and inspections are followed. Any indication that the pressure washing system was not operated and maintained according to these instructions may cancel the manufacturers' warranty.

Controls – Make sure all controls turned to the off position.

Pump – Oil level - Level the pressure washer. Be sure oil level in the pump is correct on dip stick. If the level is low, add the correct oil to the proper level. **USE ONLY SAE 30 W NON-DETERGENT OIL OR HYDRAULIC 68. DO NOT OVER FILL.**

Visually inspect all electrical components to assure they are in good condition, showing No signs of exposure, breakage or splicing.

Visually inspect all hoses, nozzles and guns to assure they are in good condition. If replacements are necessary they must be rated to withstand the machines operating pressure and temperatures.

2. **Attach high-pressure hose** to water outlet quick connector. Attach the other end of high pressure hose (with quick coupler) to spray gun. Ensure that quick disconnect connections are tightly locked together. Apply a sharp pull on hose to confirm they are secured.

Attach wand nozzle specific to task requirements (i.e. chemical or pressure wash). [Quick Coupling Operation – Pull back sleeve end and insert male end into nozzle quick coupler, release sleeve and confirm connection by pulling on nozzle].

3. **Attach water source** to water inlet located on pump. The water source must be attached with a good quality standard garden type hose (1/2" minimum is required). Connect male fitting into the female pump inlet fitting. Make sure that the inlet screen/filter is intact and fitted correctly. Turn on water source. **WATER MUST BE IN SUFFICIENT SUPPLY, AND PRESSURE MUST BE BETWEEN 20 –60 PSI TO ENSURE PROPER AND SAFE OPERATION.** Specific attention should be given if using a well water supply. Ensure water is flowing from end nozzle with trigger gun pulled. Deplete system of all air.

4. **Start electric motor.** Turn PUMP switch to 'ON'. PUMP switch is located on the frame beside the motor, or for auto stop/start systems, PUMP switch is located on the electrical box.

5. **Pressure adjustment** - The pressure regulator (unloader) is located on the pump (see diagram). It controls pressure being generated by the pressure washer. This regulator may be adjusted to the desired pressure by turning the adjustment knob. Turning the adjustment knob clockwise will increase the pressure. **NEVER OPERATE SYSTEM AT A HIGHER PSI THAN THE MAXIMUM RATING.** This machine has been adjusted to operate at a specific maximum pressure as per the machine specifications. Pressure may be reduced for lighter use by turning the Pressure Regulator/Unloader counter clockwise. If continuing to turn the unloader clockwise does not increase the pressure, then this implies the maximum has been reached for the system. Any further turning of the unloader will cause the pressure to spike when the wand trigger is released, resulting in possible damage to the machine. To avoid this effect, loosen the unloader (counter-clockwise) until the pressure just starts to drop (see pump head pressure gauge) and until it no longer exceeds the maximum pressure rating for the machine.

6. **You are now ready to start the cleaning operation** - Pull trigger on the pressure wand assembly to start cleaning. To stop the pressurized water, release the trigger. **DO NOT LEAVE UNIT RUNNING WHEN NOT IN USE.**

7. **To stop Operation.** Turn PUMP switch to 'OFF'. Squeeze and release trigger after shutting off to relieve system of pressure.

8. **Prior to storage** – Inspect pressure washer for any damage or required maintenance. If your machine is to be exposed to cold weather, please refer to winter pump instructions found in this manual. If possible, do not allow unit to remain outside in the elements.

9. **Warning** – If unit is left running while not in use, pump damage may occur. Do not leave unit running while not in use!

CHEMICAL APPLICATION

Downstream Chemical Injection: Standard (Direct Drive Units) High Pressure Soap (Belt and Flange Driven Units) (Optional)

NOTE: Do not remove back flow preventer as chemical may flow back into potable water source. For standard chemical injection, ensure the black nozzle is properly fitted at the end of the wand. The chemical injector will not function if this nozzle is not fitted.

1. Chemical preparation – Select detergent/chemical that best suits your cleaning task. Prepare dilution according to the manufacturer's instructions. The volume of chemical being used may be adjusted at valve located on the chemical injector. Note: for EK Pumps, the volume is preset and cannot be adjusted.

2. Insert the intake hose, located on the chemical injector at the pump, into the chemical being used.

3. Fit black nozzle on the standard wand, or for the dual wand, turn adjustment knob on, and adjust for required flow rate. For high pressure soap systems, the black nozzle is not needed; use one of the other wand nozzles.
4. To apply chemical, engage trigger on pressure wand assembly. Turn chemical injector's nipple to adjust flow. For the high pressure soap systems, open ball valve and engage trigger.
5. Chemical can now be applied through pressure wand assembly. It will take 5 – 15 seconds for chemical to travel to spray nozzle. The volume of chemical being used may be adjusted at the chemical injector.
6. For best results apply chemical from bottom to top, and allow for proper penetration time prior to rinsing. Do not allow chemical to dry. Rinse from bottom to top and then top to bottom.

WINTER PUMP PROTECTION

The following procedure MUST be used when the pressure washing unit is stored at temperatures below freezing.

1. All water must be drained or blown (via compressed air) from system. Connect a short piece of male fitted ½" garden type hose on to the female inlet on the pump.
2. Place the open end of the hose into a wide mouthed container of full strength, winter rated, vehicle windshield washing fluid or Anti-Freeze, **RATED FOR MINIMUM -40°C**.
3. Connect the pressure wand assembly.
4. Start the pump and engage trigger on the pressure gun. Operate the system until the fluid runs the same color as the windshield washing fluid. Your machine is now prepared for storage.
5. Disconnect fluid supply, blow out with compressed air, and cap end.

GENERAL MAINTENANCE

Water Condition

Use a softener on your water system if local water is known to be high in mineral content. The advantages of soft water are very beneficial: prevents scale buildup in heater coil, cleans better with considerably less detergent, prevents streaking on painted surfaces and glass when rinsing.

MAINTENANCE CHECKLIST

Daily

1. Check pump oil for proper level and adjust accordingly.
2. Examine the quality of the oil.
3. Check pump for oil and/or water leaks.
4. Inspect and clean inlet filters.

Weekly

1. Examine all fittings, components, hoses, connections, and nozzles for damages, loose parts, or leaks. – Replace accordingly—

Recommendation for Oil Changes and Component Replacement

1. Change the oil in the pump after the first 50 hours and every 500 hours after the initial oil change. Use SAE 30 W Non-Detergent for GP Pumps and Hydraulic 68 for EK Pumps.
2. Change all other components on the pump as needed.

GLOSSARY OF TERMS

AUTO START/STOP – Unit will automatically start when the trigger is pulled, and it will stop the motor on time delay after the trigger has been released in order to prevent the pump from bypassing and overheating.

PSI – Pounds per square inch. Pressure washers are designed and rated to operate at a specific PSI. Operating at pressures exceeding the maximum rating could result in damage to the unit and/or SEVERE PERSONAL INJURY.

GPM – Gallons per minute. The orifice on the pressure wand assembly has been selected to deliver up to the maximum GPM for your machine.

PRESSURE WAND ASSEMBLY – This refers to the gun, wand, and nozzle.

PUMP – The pump moves the water through the system and delivers it to the pressure wand assembly.

UNLOADER VALVE – Is a valve located at the head of the pump for unloading water back into the bypass when the trigger gun is shut off. It also reduces the load on pump when gun is off.

OIL, PUMP – The oil used within the pump to lubricate its operation. It is Important to use only SAE 30 W Non Detergent (for GP Pumps) or Hydraulic 68 (for EK Pumps) in the pump.

BACK FLOW PREVENTER – Device to prevent flow backwards into potable water supply.

MAXIMUM WORKING PRESSURE - Each machine is equipped with a safety pressure relief valve which prevents over pressurization of the high pressure system. It is an important safety device and must not be tampered with in any way.

PRESSURE SWITCH - A pressure switch is used to control the motor for the auto stop/start feature (see diagram).

FLOW SWITCH – A flow switch is installed on the outlet of the high pressure pump and will shut off the pump and motor in the absence of water flow as well as turning it back on when flow is detected (by squeezing the trigger).

COMPONENT IDENTIFICATION

Commercial Model:

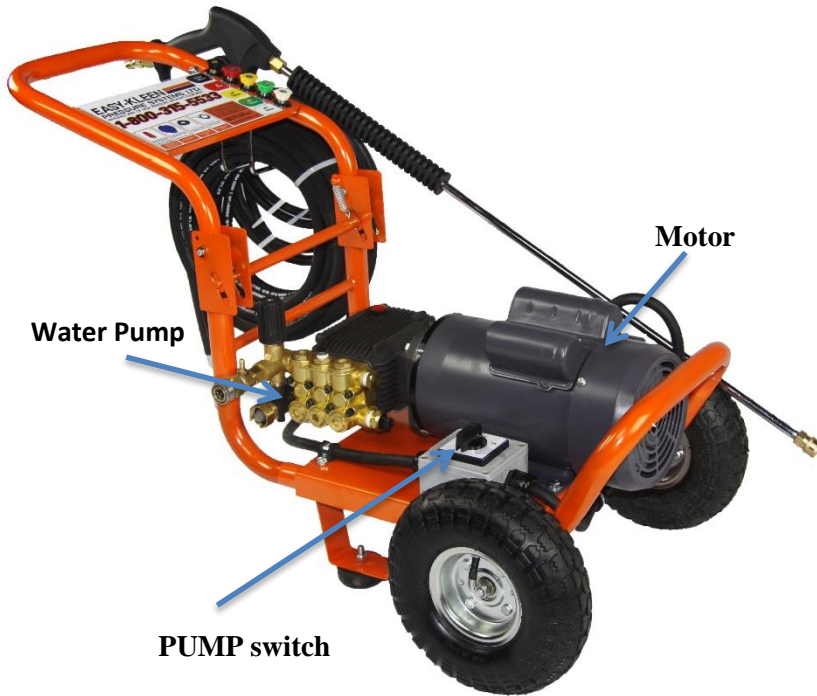

Hand Carry Frame



Wall Mount Frame

Industrial Model:

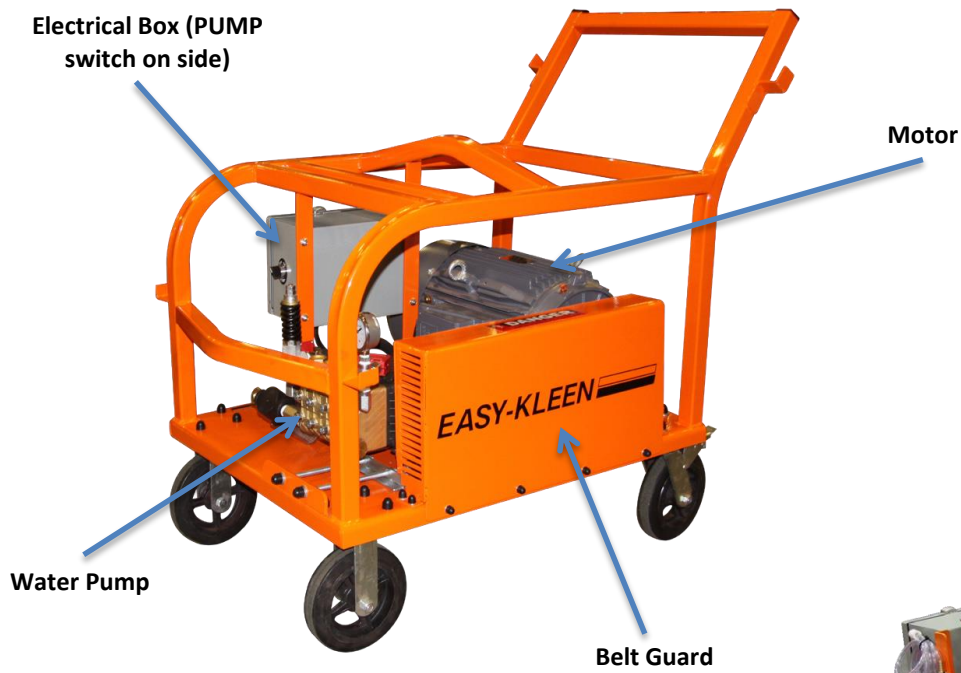

*Model shown with *optional* auto stop start.



Stationary Frame

Pressure Wand Assembly:

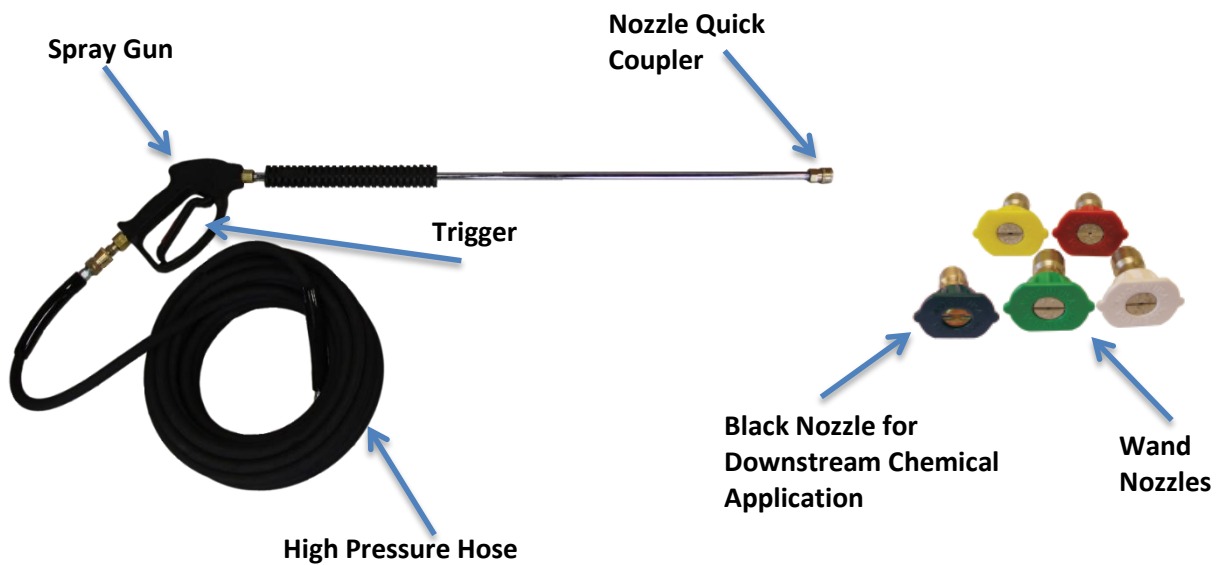

Firehouse and Car Detailing System:

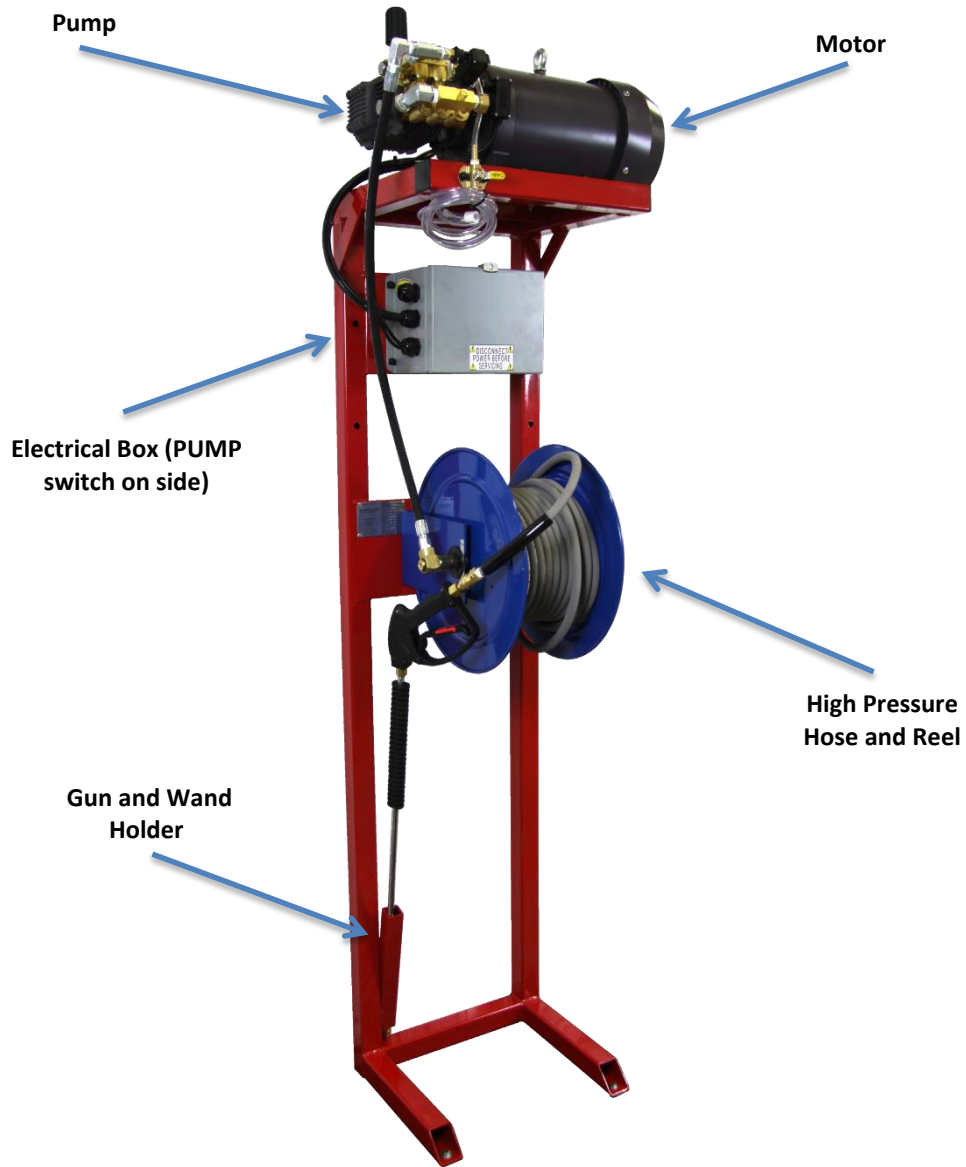

Manual Stop/Start Pump Assembly:

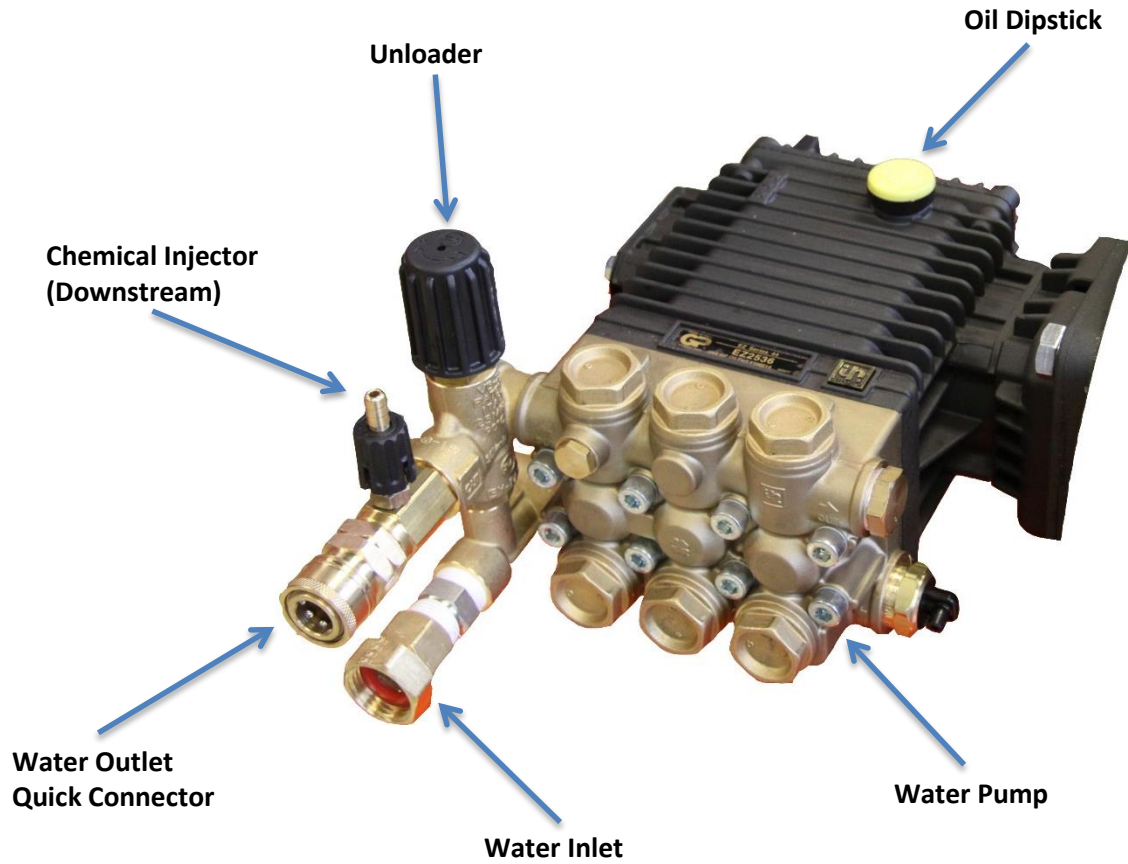

Auto Stop/Start Pump Assembly:

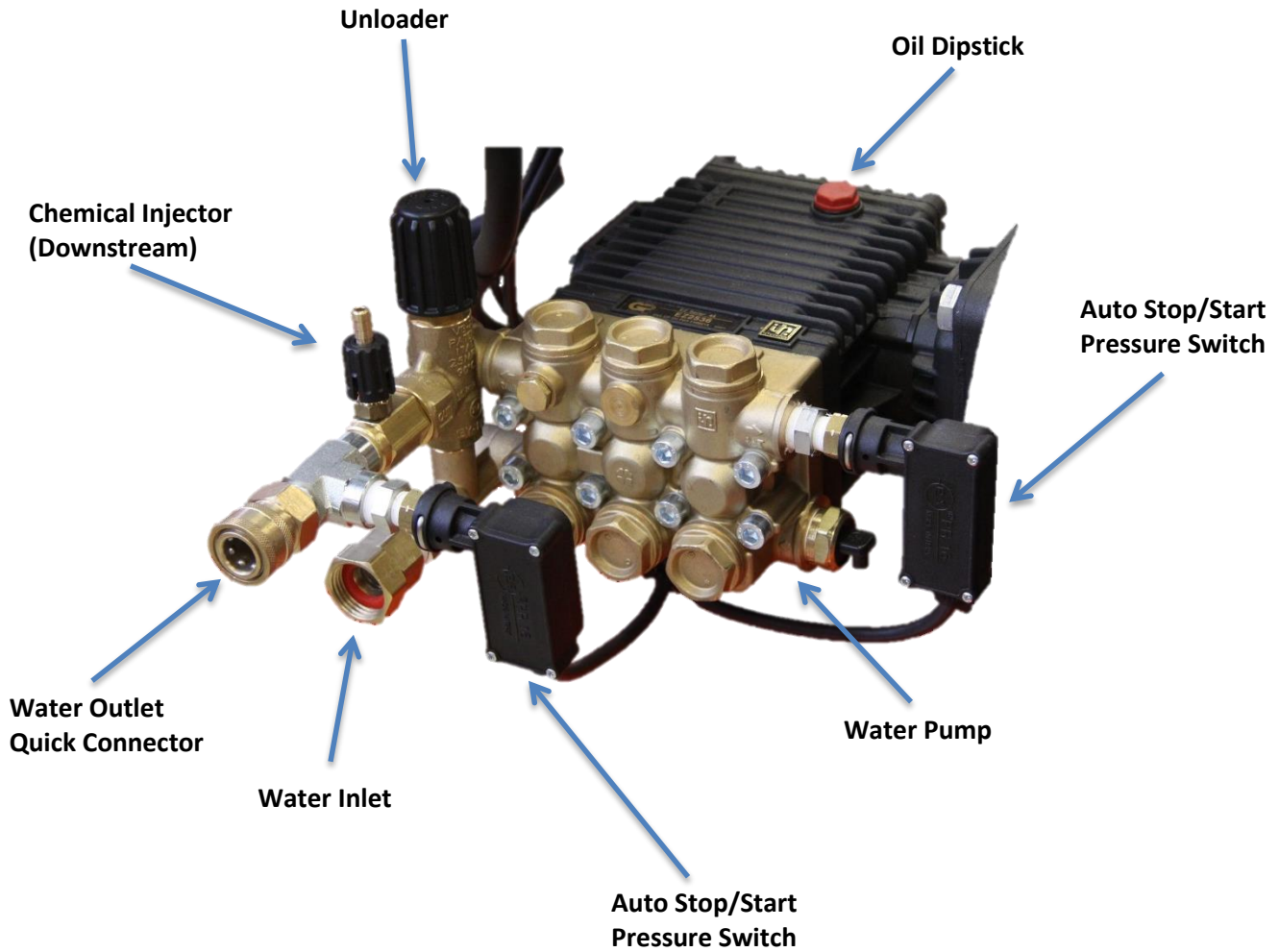

Firehouse and Car Dealing System Pump Assembly:

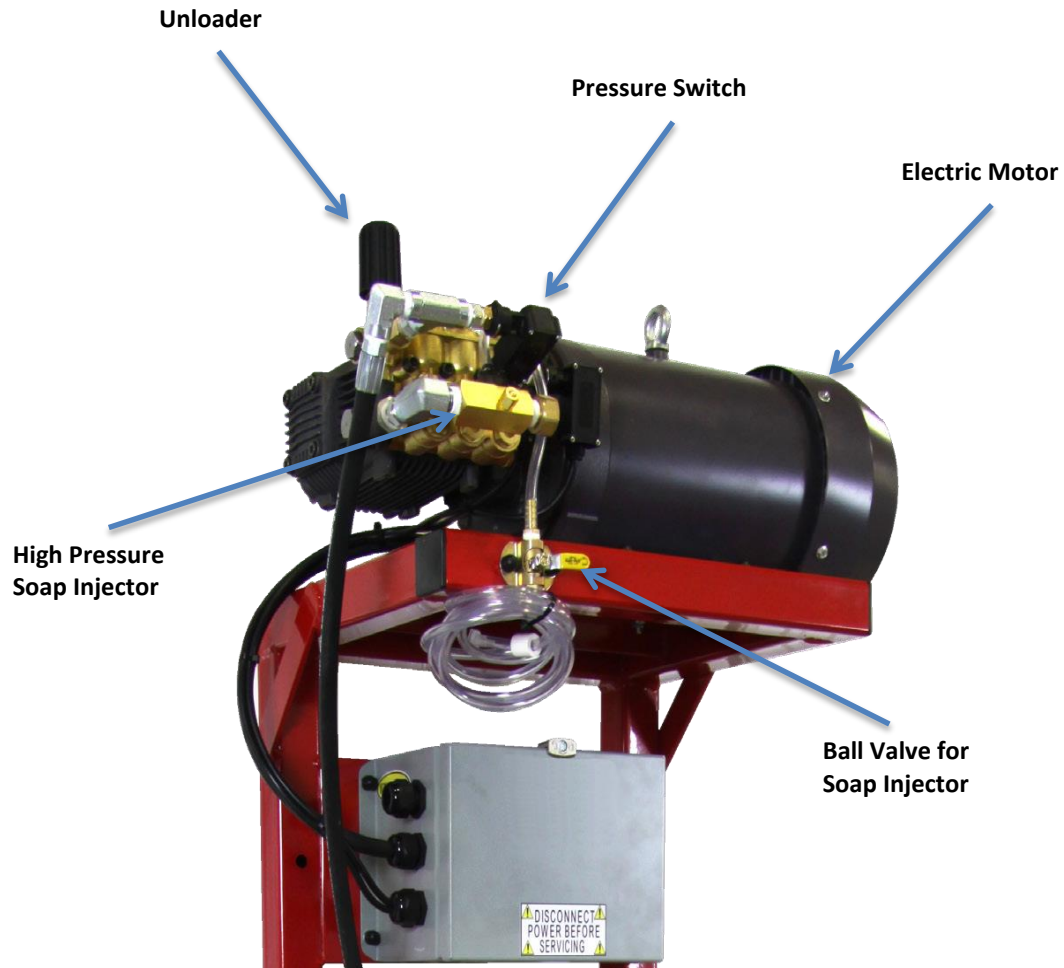

Belt Driven Pump Assembly:

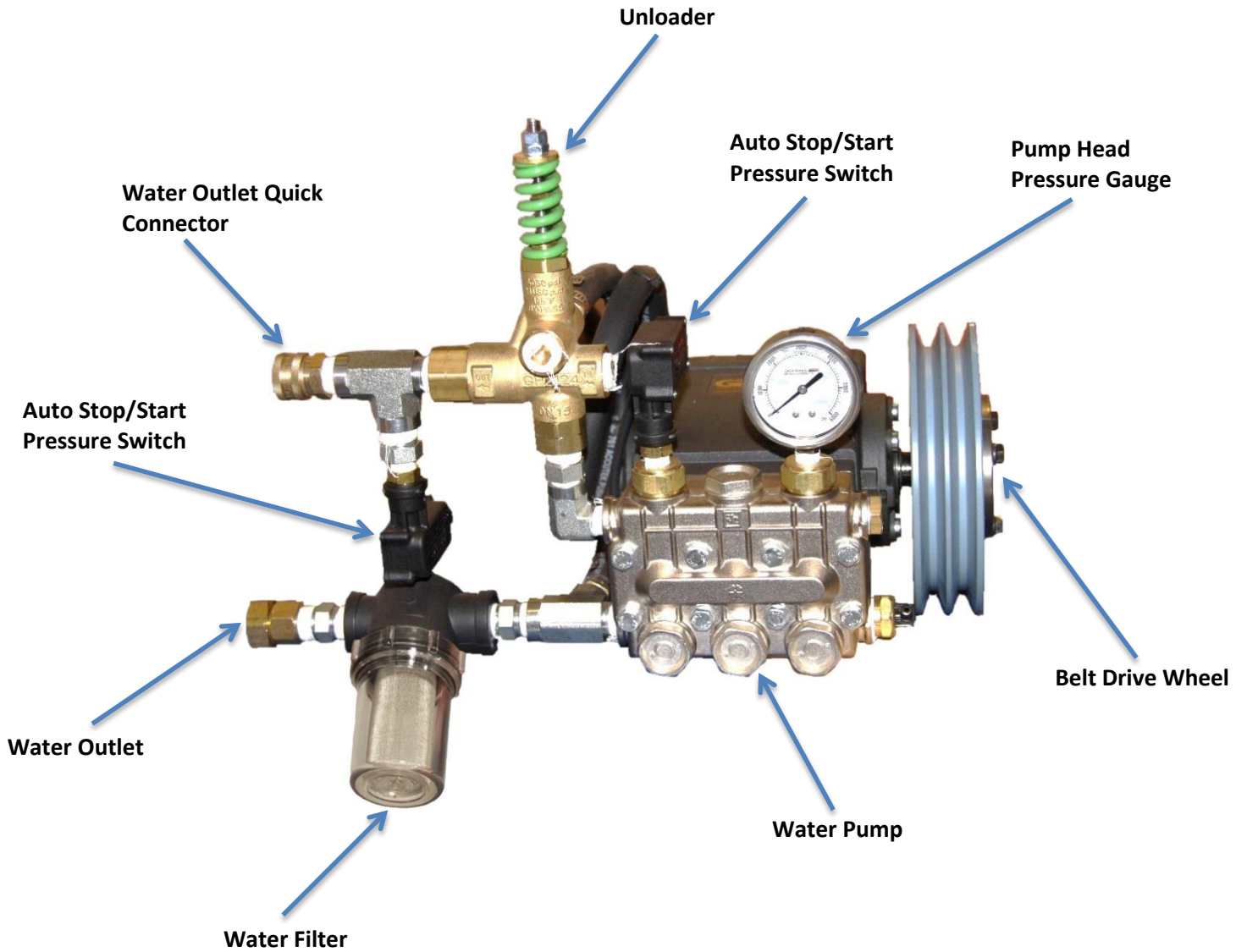

QUICK DIAGNOSTICS AND SOLUTIONS GUIDE

PUMP		TYPE OF OIL
EK Pump		Hydraulic 68 (650ml)
GP Pump		30W SAE Non-Detergent
PROBLEM	POSSIBLE CAUSES	SOLUTIONS
PRESSURE		
No pressure or Very low pressure	Metal in oil	<ul style="list-style-type: none"> - Examine oil in pump to see if there is metal in oil. - If you find traces or pieces of metal, your pump has damaged components.
	Dirt in water	<ul style="list-style-type: none"> - Verify if there is dirt in nozzle tip or in valves in pump. - If nozzle is plugged, clean or replace it. - If valves in pump are clogged, clean valves. - If valves in pump are damaged, replace valves.
	Wrong nozzle size	<ul style="list-style-type: none"> - Make sure you have the right nozzle size. The black nozzle will drop pressure in order to use chemical injector and is only for soap or chemical. If you are not using soap, use a different color.
Pressure too high	Wrong nozzle size	<ul style="list-style-type: none"> - Make sure you have the right nozzle size.
	Unloader adjusted improperly or damaged	<ul style="list-style-type: none"> - Check pressure of pump with a pressure gauge and adjust to desired pressure. - If you cannot reduce pressure, replace unloader.

EASY-KLEEN

PRESSURE SYSTEMS LTD.

MANUFACTURER OF HIGH PRESSURE CLEANING EQUIPMENT

MANUFACTURER'S WARRANTY

The manufacturer warrants all original equipment of the manufacturer to be free from defects in material and workmanship as follows:

Pump Head	10 years
Pump Crankcase	5 years
Internal Pump Parts	90 days
Heating Coil	5 years, 1 prorated
Honda Engine* Kohler Engine* Others	3 years, 1 year
Electric Motor*	1 year
Frame and Body Materials	Lifetime
Burner Assemblies	1 year
Wheels and Castors	90 days
Accessories, Unloader, Safety Valves	90 days
Hoses, Fittings, O'Ring, and Elastomers	90 days
Pressure Gauges	90 days

Within the periods stated above and at the discretion and approval of Easy-Kleen, if there is shown to be a defect in material or workmanship, the defective parts will be repaired or replaced at the manufacturers place of business or an original manufacturers repair depot when returned PREPAID. This warranty will not cover labor if warranty work is conducted at the customer's place of business. Road service will be charged at the normal rate in these situations. Damage resulting from freezing, accident, neglect, tampering, abuse, alteration, or improper installation and operation will automatically void this warranty.

All labor repairs are to have an Easy-Kleen pre-authorized repair number (PARN). In order to receive a PARN, please email a copy of your invoice to our service department and make sure to clearly indicate the date of purchase and the serial number of the machine. A pre-determined service time will then be appointed to you. If new parts are needed, they will be invoiced to you as normal. Defective parts are to be sent to us prepaid for warranty and consideration. If a part is found to be defective, a credit will be issued to cover the costs of parts and shipping.

Note: This warranty will not extend to consequential damage or liability that occurs as a result of original defect.

* Due to original equipment manufacturer's requirements, Easy-Kleen is not permitted to perform warranty repairs or claims for electrical motors, gas, or, diesel engines. If you require warranty information for these please call our service department and they will put you in touch with your local warranty representative.

If you have any questions or comments regarding this warranty please call 1-800-315-5533.

Easy-Kleen Pressure Systems Ltd
41 Earnhardt Rd
Sussex Corner, NB, Canada
E4E 6A1

E-mail: sales@easykleen.com

website: www.easykleen.com

CIRCUIT DIAGRAM

AUTO START STOP SINGLE PHASE 120V/240V AC COLD WATER WITH PRESSURE SWITCH

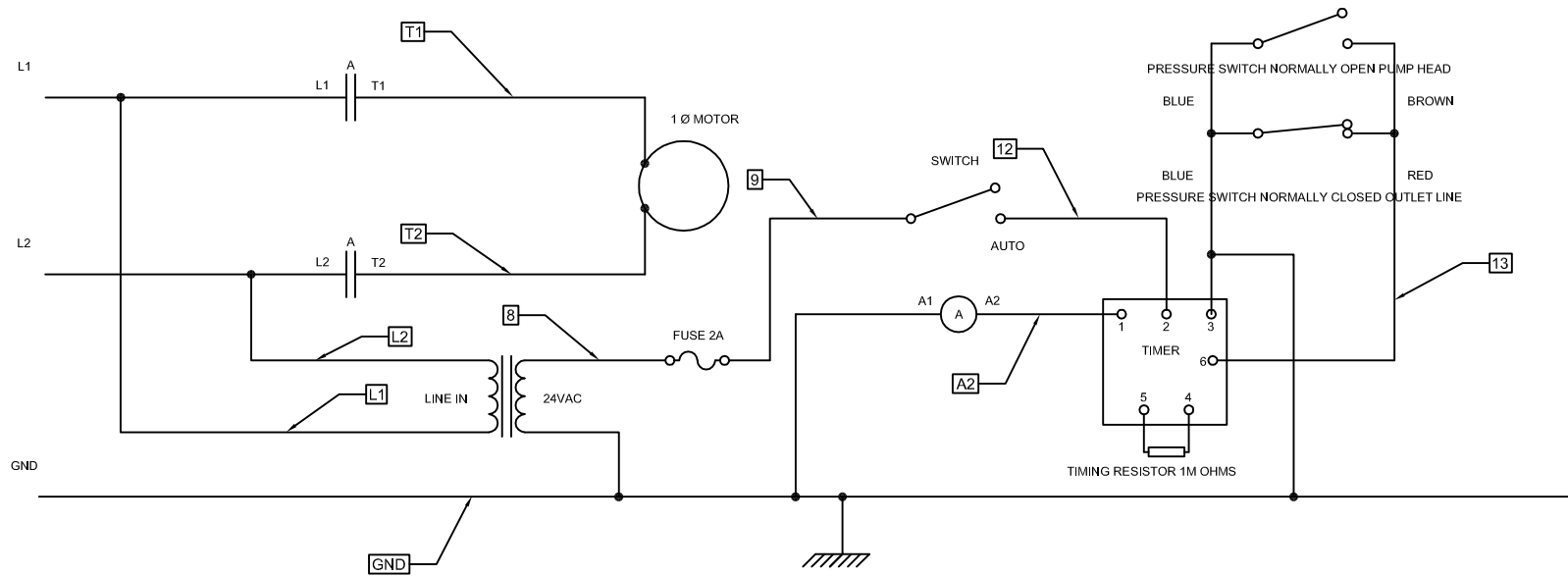

CIRCUIT DIAGRAM

AUTO START STOP SINGLE PHASE 120V/240V AC COLD WATER WITH FLOW SWITCH

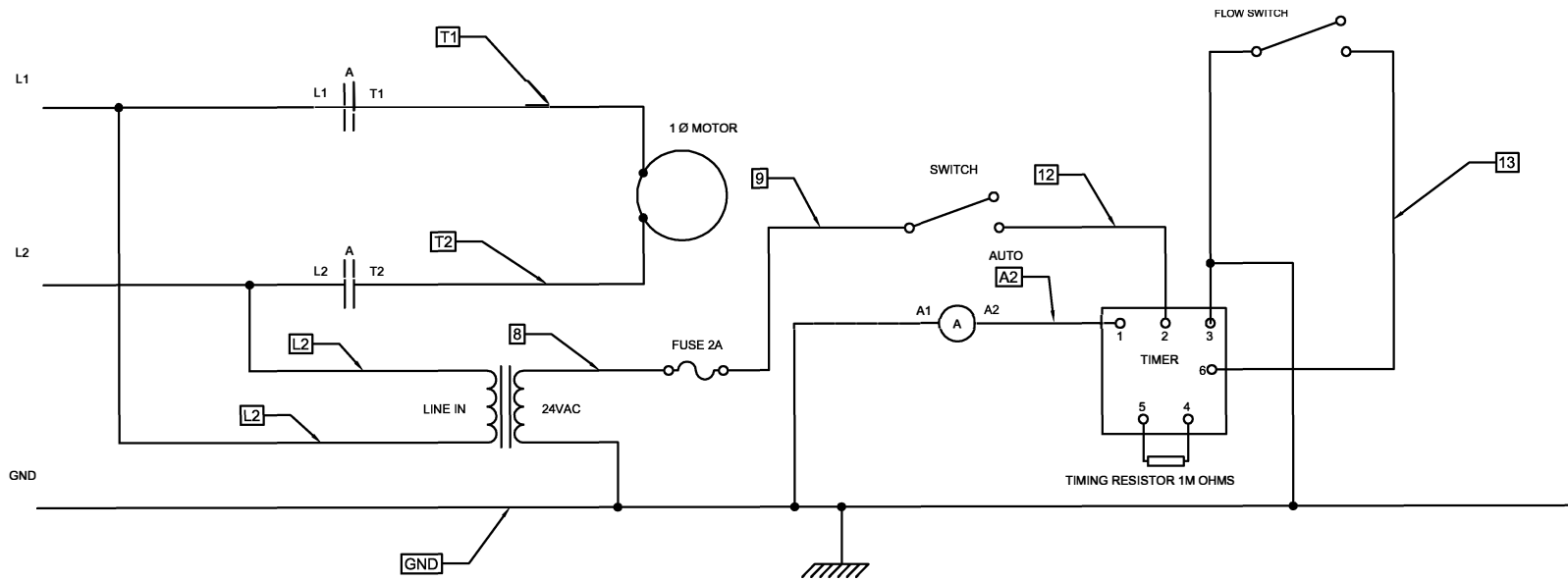

CIRCUIT DIAGRAM

AUTO START STOP 3 PHASE 208/230/460/575V AC COLD WATER WITH FLOW SWITCH

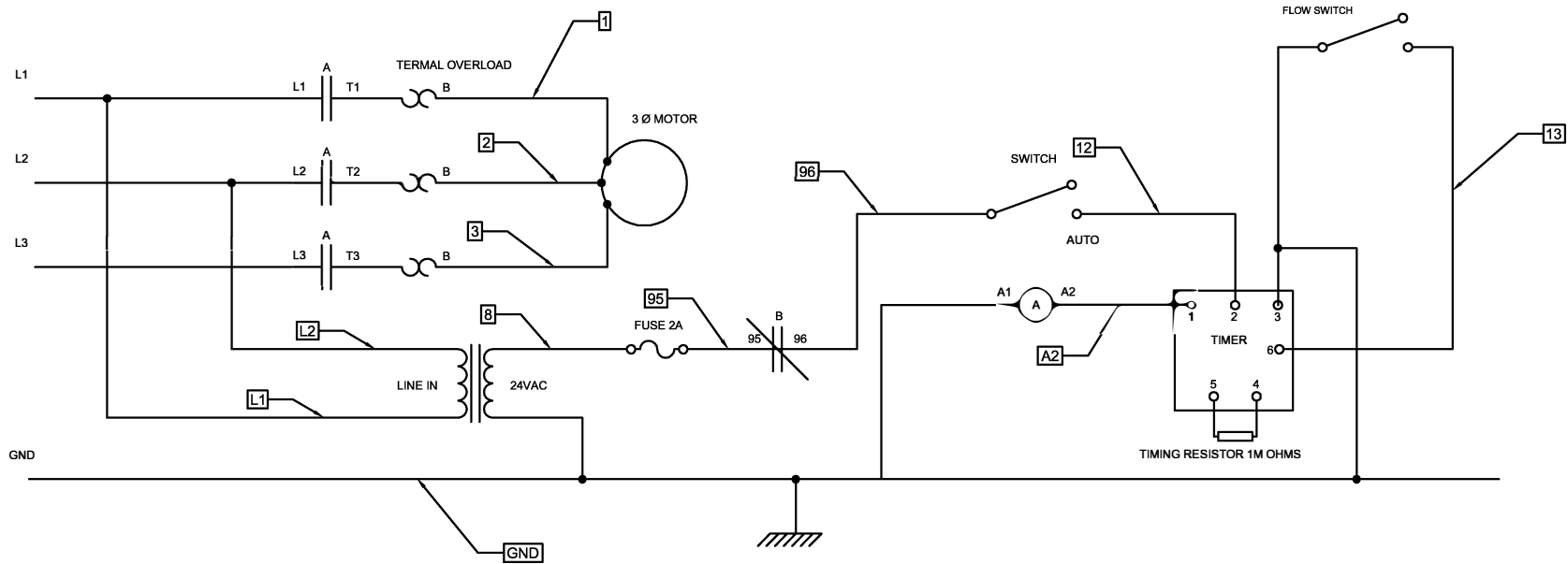

CIRCUIT DIAGRAM

AUTO START STOP 3 PHASE 208/230/460/575V AC COLD WATER WITH PRESSURE SWITCH

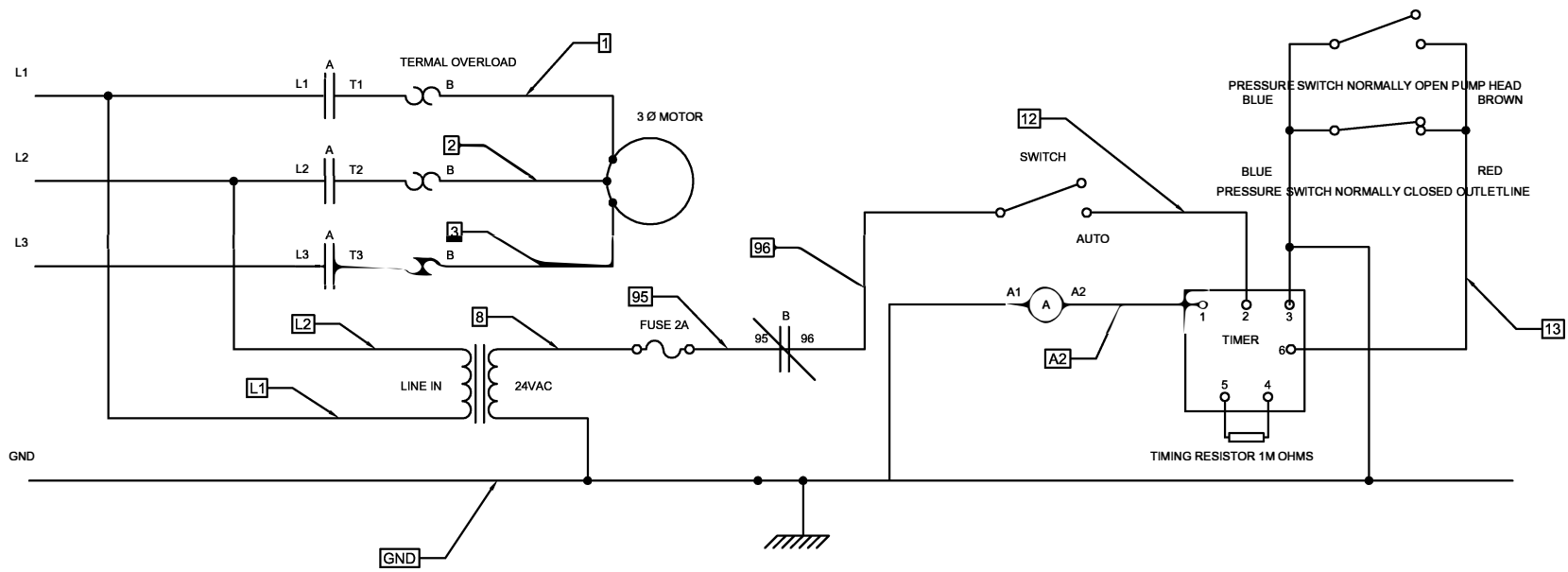

CIRCUIT DIAGRAM

MANUAL START STOP 3 PHASE 208/220/460/575V AC COLD WATER WITH CONTACTOR AND TRANSFORMER

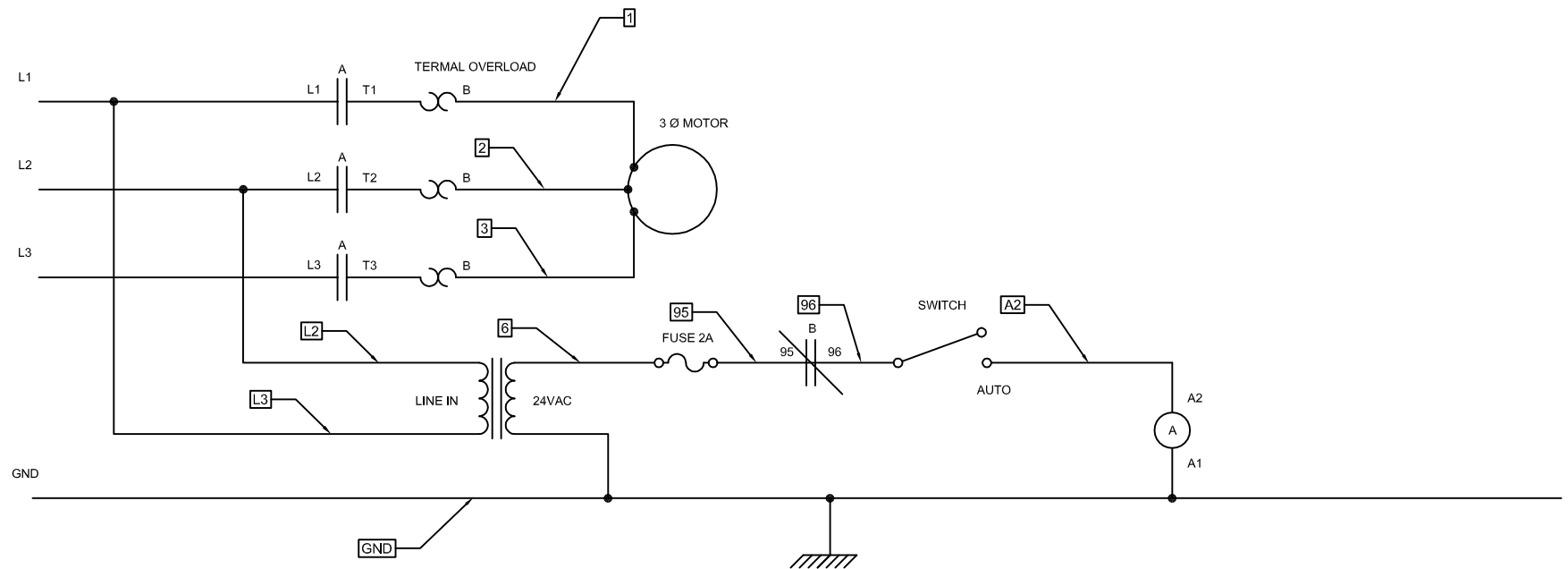

Easy-Kleen Pressure Washers

Service Manual

This manual is intended for technical personnel to assist in the diagnosis and repair of issues with pressure washers.

Some of the information in this manual will apply to other pressure washer models and may not apply to this model.

This manual is not intended for use by non-technical personnel.

It is advised to always refer to competent technical personnel when repairs are advised to avoid equipment damage or potential personnel injury.

If you have any technical questions please do not hesitate to call us at 1- 800-315-5533.

POWER SYSTEM DIAGNOSTICS - Gas Motor Not Starting

PROBLEM	POSSIBLE CAUSE	SOLUTION
Gas motor not starting	Fuel	Check to see if proper fuel levels are maintained
	No ignition	Check ignition by removing spark plug from cylinder. If electric start, try starting using the recoil starter.
	Electric Starter/Battery	Recharge or replace battery.
	Fuse blown in key switch	18 amp engine, open key switch, replace 30 amp fuse
Spark Plug - strong gas smell	Flooded	Wait 5 minutes before attempting to restart.
	No ignition	Check ignition by removing spark plug from cylinder. If electric start, try starting using the recoil starter.
	Bad plug	Check spark plug and replace if necessary. Carbon deposits can indicate a fouled plug or too much fuel.
Plug does not fire	Poor connection	Inspect the ignition connection.
	Bad magneto	Check the source of spark plug for engine ignition.
Bad ignition system	Poor connection	Check the source of spark for the engine ignition.
Spark Plug - no gas smell	No fuel to cylinder	Check fuel delivery from carburetor to cylinder. Check carburetor float bowl for fuel.
	Fuel line restricted	Inspect fuel line to carburetor for restrictions or clogging. Flexible line may be kinked.
	Stuck carburetor float	Unstick float
	Clogged carburetor needle valve	Unclog needle valve.
	Bad fuel pump	Replace fuel pump.

FLUID SYSTEM DIAGNOSTICS - Flow and Pressure

PROBLEM	POSSIBLE CAUSE	SOLUTION
No Flow	No power	Make sure pump is operating. Check drive belts and couplings, make necessary adjustments.
	Trigger gun valve	Check trigger gun, repair or replace.
	No water source	Ensure water supply is not restricted and hoses are in good repair and not kinked.
	Clogged spray nozzle	Check spray nozzle, repair or replace.
	Clogged inlet filter	Check inlet filter, repair or replace.
	Float Valve stuck (optional)	Float valves can become stuck in the "UP" position. Manually dislodge and inspect for problems.
	Faulty unloader valve	Remove and check for proper action, repair or replace.
Low pressure, adequate flow	Incorrect or no spray nozzle	Nozzle should be properly sized for the system. Low pressure indicates that the nozzle in use is too large.
	Worn spray nozzle	Replace nozzle when it shows signs of internal erosion.
	Debris in valves	Clean valves and check o-rings for pits and cracks.
	Lance on low pressure	Adjust pressure so the water flows through properly.
	Unloader is not adjusted correctly	Adjust unloader to proper level.
	Pressure gauge inaccurate	Use a new pressure gauge on a quick connect at outlet to check system pressure and replace if gauge is faulty.
	Pump packings bad	If low pressure persists, pump packings may need replaced.
Low pressure, low flow	Volume Improperly adjusted	If unit has volume adjustment, it may need readjustment
	Discharge leaks	Look for leaks on the discharge side of system.
	Downstream chemical injector (Dema)	Remove the injector and retest system. If the flow is restored, replace the injector.
	Loose drive belts	If belts do not have proper deflection, replace them.
	Pump not running at rated speed	Check engine throttle and see that the motor is rated for the same speed as the pump.
	Stripped pump drive coupling	Inspect coupling and repair or replace.
	Defective easy start valve (optional)	Check the start or throttle-back valve for proper operation.
	Malfunctioning motor or gear	Ensure that the motor or engine is working properly
Low pressure, low flow - Bogs	Unloader stuck in bypass	Piston assembly may be stuck or fouled
	Outlet restriction	Build up can restrict flow. If water is not flowing freely, flush with garden hose to isolate the clog or restriction.
	Clogged nozzle	Distorted spray pattern can indicate a clogged nozzle.
	Nozzle too small	Ensure nozzle is proper size for the system.
	Hose restriction	Correct any kinks or restrictions. Replace crushed hoses.
	Debris in the system	Debris can lodge in the discharge side of the system (valves, fittings, injectors, filters) Flushing with water may correct it.

PROBLEM	POSSIBLE CAUSE	SOLUTION
Excessive pressure	Small spray nozzle	Nozzle must be properly sized for the rated flow and pressure. Reset unloader or pressure relief if nozzle size is changed.
	Faulty pressure gauge	Check the pressure gauge using a properly calibrated pressure gauge on quick connects at the equipment outlet.
	Improperly adjusted unloader	Adjust to the proper pressure using pressure gauge.
	Faulty unloader	Check the unloader action. If it is not working properly, it may need repaired or replaced.
Pump chatters, cavitation, vibration	Air in system	Inspect places where air can enter the system. i.e. fittings, hose, connections etc.
	Chemical line not submerged	If the chemical valve is on, ensure that the chemical line is fully submerged in the chemical
	Inlet line restricted	All inlet connections should be snug and not kinked to reduce the chances of pump starvation.
	Inadequate water supply	Water supply to the system must meet or exceed the rated flow (GPM) on the serial number plate. Faucet must be completely opened or water above the tank outlet in a gravity fed system.
	Float valve stuck (optional)	If float valve is stuck in the up position, water can not enter the float tank. Unstick valve if possible or replace if necessary.
	Turbulence in float tank (optional)	Excessive turbulence allows the pump to draw air into the system. Correct excessive turbulence.
	Inlet or inlet strainer clogged	Regularly clean the inlet and inlet strainer to keep debris from entering the float tank
Inlet line vibrates	Water supply too hot	Inlet temperature should not exceed 140F - 160F range.
	Air in system	Inspect places where air can enter the system, i.e.; fittings, hose, connections etc.
	Debris in inlet check valves	If there is no float tank and the outlet line does not vibrate, the inlet check valve may be clogged. Remove debris. Check o-rings under valves.
Outlet line vibrates	Air in system	Inspect places where air can enter the system, i.e.; fittings, hose, connections etc.
	Debris in inlet check valves	If there is no float tank and the outlet line does not vibrate, the inlet check valve may be clogged. Remove debris.
	Pump packing bad	If they show signs of wear or damage, replace them.
Inlet and outlet lines vibrate	Inlet and outlet check valves fouled	Look for the source of debris in the inlet and discharge check valves and remove.

FLUID SYSTEM DIAGNOSTICS - Unloader

PROBLEM	POSSIBLE CAUSE	SOLUTION
Very low or no flow	Unloader stuck in bypass	Isolate the flow problem. If it occurs before the unloader discharge point, check the piston assembly to see if it is fouled or stuck in bypass mode.
Unloader will not unload	Debris in unloader	Take bottom nut off unloader, identify ball, spring and seat. Clean out any debris and
	Sever leak on the outlet of unit	Check for leaks and repair.
Unloader (flow) cycles with system under pressure	Improper flow	Any variation in flow form what the orifice is sized can cause cycling. System must produce the rated flow constantly.
	Nozzle too small	A nozzle that is too small can cause the flow to be reduced.
	Nozzle clogged	A distorted spray pattern indicates a clogged nozzle.
	Improper unloader orifice	The systems rated output should indicate the proper sized orifice for your system.
	Unloader orifice clogged	Check the orifice for clogs and clear out any debris.
	Injector orifice clogged	If the system has a Venturi injector downstream of the unloader, check the orifice for clogs.
	Other downstream restriction	Scale buildup can restrict flow. Check; controls, valves, switches, trigger gun, and lance. Descale as necessary and begin preventive maintenance program for scale prevention.
	Pump not delivering the rated pressure	See low pressure or low flow diagnostics.
Unloader (flow) cycles with system in bypass	High water supply pressure	Check inlet water supply for excessive pressure.
	No restrictions on the unloader	Check unloader bypass port to see if a flow restrictor is properly installed. Install one if none is present.
	Downstream leakage (excessive)	Causes the unloader to since a continuing flow and divert it to the closed gun. Repair or replace.
Unloader (pressure) produces smooth flow & low volume	Accumulator downstream (option)	Remove the accumulator from the system.
	Unloader adjusted too low	Adjust the unloader using the pressure gauge for the correct pressure.
	Spray nozzle clogged	A distorted spray pattern indicates a clogged nozzle.
	Spray nozzle too small	A small nozzle causes a reduced flow and cycling may result.
	Injector orifice blocked	If the system has a Venturi injector downstream of the unloader, check the orifice for clogs.
Unloader (flow) produces smooth flow & low volume	System not delivering rated flow	See flow diagnostics.
	Unloader adjusted too low	Adjust unloader and regulator until proper pressure is achieved.
	Unloader valve stuck in bypass	If unloader is sticking, repair or replace as necessary.
	Restriction in system	Downstream restrictions can cause a reduction in flow. Check; controls, valves, switches, trigger gun, and lance. Descale as necessary and begin preventive maintenance program for scale prevention.

Unloader (pressure) produces low flow and normal pressure	Unloader adjusted too low	If the unloader is diverting flow to bypass it may be adjusted too low, readjust as necessary.
	Spray nozzle too large	Ensure the proper nozzle is installed on system.
	Internal nozzle erosion	The number of hours of usage can give you a clue to the extent of the wear. If in doubt, change
	Insufficient pump pressure	Check pump seals and packings and tighten drive belts.
Unloader (flow) produces low flow & normal pressure	Unloader adjusted too low	If unloader is diverting flow to bypass, readjust using the pressure gauge.
	Nozzle too large	Ensure the proper sized nozzle is being used.
Unloader (pressure) leaks from main spring or adjusting bolt	Shaft O-ring in valve body worn	Check O-rings for wear or damage and replace as necessary.
Unloader (flow) pressure increases when trigger released	Unloader piston stuck or frozen	Check unloader shaft for proper action. Unstick piston and shaft or replace unloader.
	Bypass port clogged or restricted	Ensure that unloader bypass port is not clogged
	Excessive tension on main spring	If tension is incorrect, adjust or replace as necessary.
Unloader (flow) leaks water around adjusting bolt	Sleeve O-ring worn	Check O-rings for wear or damage and replace as necessary.

FLUID SYSTEM DIAGNOSTICS - Leaking
ANY LEAKS SHOULD BE REPAIRED ASAP TO PREVENT DAMAGE TO THE SYSTEM.

PROBLEM	POSSIBLE CAUSE	SOLUTION
From inlet	Garden hose washer	Ensure the washer is present and in good condition.
From low pressure (inlet) line fittings	Loose clamps or connections	Low pressure line should be properly sealed on barb and tightly clamped.
From float tank(option)	Float tank full of water or stuck	If float is not floating above water, check the float to see if it has filled up with water. If necessary, drain and seal.
From pressure fittings	Fittings not tightened or taped, or cracked	Usually metal to metal fittings should be taped with Teflon tape or lock tight to provide a tight seal. (unless
From quick connects	Bad o-rings	If quick connect o-ring shows wear or damage, replace it.
From pump	Bad packing	If the seal leak is detected under the pump manifold, packing may be worn and in need of replacement.
From trigger gun	Bad rod o-ring	If o-rings show wear or damage, they may need replaced.
	Stripped connectors	Physical damage may not be apparent, but unseen warping from freezing or extreme pressure can still cause leakage.
From nozzle	Weep gun (optional)	If a weep gun has been installed, check the gun valve seat to ensure it is functioning properly.
	Damage gun valve ball or seat	Inspect trigger gun valve assembly for damage or wear to ball or seat. Lodged debris can stop valve from closing. Repair with kit or replace.
From unloader	Bad o-rings or seals	If quick connect o-ring shows wear, damage or improper seating.
From variable pressure Lance(option)	Bad o-rings at adjusting knob	Inspect o-rings for wear or damage and replace as necessary.
Unloader will not unload	Debris in unloader	Take bottom nut off unloader, identify ball, spring and seat. Clean out any debris and reassemble.
	Sever leak on the outlet of unit	Check for leaks and repair.
From pressure relief valve	System over pressure	See pressure and flow diagnostics to find the cause of the excessive pressure and correct it.
	Clogged nozzle	Spray pattern will be distorted if nozzle is clogged, clean out.
	Trigger gun valve not working	If trigger gun valve action is not correct, repair or replace.
	Excessive pressure spike	If water spurts from valve when trigger is released, check unloader adjustment. Pressure spike should be below the level where pressure relief valve is activated.
	Wear or damage to ball or seal	Inspect ball and seal for damage and adjust as necessary.
	Improper relief valve adjustment	Adjust valve properly.

FLUID SYSTEM DIAGNOSTICS - Trigger Gun/Spray Nozzle

PROBLEM	POSSIBLE CAUSE	SOLUTION
No nozzle flow from nozzle when trigger depressed.	Broken piston rod in trigger gun	If water flows through discharge hose without gun, check trigger gun valve piston rod and replace if necessary.
	Missing metal insert in trigger gun (European style gun)	Inspect to assure insert is in place.
	Blockage in system past gun	Check nozzle or spray accessory for blockage and clear it.
Excess pressure when trigger gun is released	Excessive pressure spikes	After unloader increases pressure to a maximum, further adjustment will only increase the pressure spikes. Re-adjust.
Flow not stopping when trigger gun released	Broken return spring on trigger gun	If trigger action is too loose, return spring may need replaced.
	Debris in gun valve	Debris in gun valve can stop piston return. Clear debris.
Trigger action sticks	Keeper plug too tight	It may be possible to loosen plug slightly without leakage but it will likely need replaced.
Trigger gun leaks	Worn or bad o-ring	Check trigger gun o-rings for wear or damage and replace.
	Stripped or loose connections	Physical damage may not be apparent but unseen warping from freezing or severe overpressure may still cause leaking.
No chemical	Chemical valve closed Black nozzle	Open chemical valve. If it chatters with no chemical delivery, air is being drawn from the upstream side of the pump. Check fittings, connections and ensure the inlet line is fully submerged into the chemical jug.
	Chemical dried up in the injector	Inspect and clean as necessary.
	Chemical foot strainer clogged	May be a strainer or check valve. Ensure that the ball is not stuck or clogged.
	Chemical line kinked	Chemical line kinking or binding prevents chemical delivery.
	Chemical line too long	An overly long chemical line can prevent the pump from drawing chemical into the system. Try installing a shorter line.
	Chemical too dilute	Verify chemical strength.
	No adjustment for low pressure	Downstream injectors only - Low pressure is required for most injectors to draw chemical. If no adjuster exists it may need low pressure spray nozzle installed on the lance.
Incorrect injector orifice	If not properly sized for the systems rated output, chemical delivery problems will result. Check serial plate for specs.	
Excessive chemical	Valve improperly adjusted, check knob on injector	To properly adjust, a chemical flow meter may be used to precisely measure chemical flow.
	Chemical dilution too strong	Verify chemical strength.
Spray pattern irregular	Clogged nozzle	Spray pattern will be distorted if nozzle is clogged.
Volume proper, pressure low	Nozzle too large	Ensure that the nozzle is properly sized for the system
	Internal nozzle wear	A loss of pressure may result from gradual nozzle wear. Replace a nozzle of correct size.
Pressure proper, volume low	Clogged nozzle	Spray pattern will be distorted if nozzle is clogged. Check nozzle for clogging if the unit has a pressure unloader.

BOILER SYSTEM DIAGNOSTICS - Boiler Controls

PROBLEM	POSSIBLE CAUSE	SOLUTION
No voltage solenoid	Boiler control or electrical problem	A multimeter can be used to check continuity through controls and pinpoint the problem areas.
Solenoid coil does not energize	Bad connection to solenoid coil	Electrical connections to solenoid valve coil should be tight and not corroded.
	Coil bad	Check to see if fuel solenoid will energize when the proper voltage is applied. Solenoid may need replacing.
	Boiler control not activating properly	If coil energizes when proper voltage is applied, check boiler controls.
Solenoid coil energizes	Problem occurring elsewhere	If solenoid valve coil energizes when the cleaner is operating in hot water the problem is elsewhere. Check the air/fuel delivery.

BOILER SYSTEM DIAGNOSTICS - Pressure Switch

PROBLEM	POSSIBLE CAUSE	SOLUTION
Switch activates when pressure is reached but boiler not firing	Control not flowing through switch	A multimeter can indicate if the proper voltage flows through the boiler side of the switch. If not the switch may not need replaced.
	Switch improperly wired	Switch may be improperly wired for its function.
	Switch bad	If wiring is proper and still no current flow when activated, switch may need replacement.
Switch does not activate	Plunger fouled or stuck	Check pressure plunger to see if it will travel freely. If not, the passage may need cleared.
	Plunger not moving far enough	Check to see if the plunger is traveling far enough to depress the microswitch. Adjust if necessary.
Switch activated manually	Current not flowing through switch	If switch activates manually but boiler does not fire, current may not be flowing through. The switch may need replacing.
	Microswitch not properly adjusted	Microswitch may need readjustment so plunger can trip in.
	Switch bad	Replace switch with another one.
	Problem elsewhere in the system.	If switch works manually and current is flowing properly, the problem is elsewhere. Try other boiler diagnostics.

BOILER SYSTEM DIAGNOSTICS - Vacuum Switch - Optional

PROBLEM	POSSIBLE CAUSE	SOLUTION
Switch activated manually	Improper diaphragm movement	Replace switch if improper diaphragm movement is detected.
	Low water flow	Correct problems related to inadequate water flow.
	Air leak in or punctured diaphragm	Replace vacuum switch if diaphragm shows an air leak or hole.
Switch shows continuity when activated	Problem elsewhere in system	If vacuum switch works properly, continue with other boiler control diagnostics.
Switch does not show continuity when activated	Switch contact bad	Replace switch with another one.

BOILER SYSTEM DIAGNOSTICS - Flow Switch - Optional

PROBLEM	POSSIBLE CAUSE	SOLUTION
Reed switch activates when tested with external magnet	Magnet fouled and will not move	If magnet does not move freely within its housing, remove debris to unstick it.
	Reed switch misadjusted	To adjust it for the flow the system is producing, loosen the reed switch and move it in its
	Magnet is bad	If reed switch activated the boiler when tested with a hand held magnet, the internal magnet may
Reed switch does not activate when tested with external magnet	Reed switch is bad	If reed switch does not activated the boiler when tested with a hand held magnet, the reed switch may need replacement.
	Problem elsewhere in system	See diagnostics listed above.

BOILER SYSTEM DIAGNOSTICS - Thermostat

PROBLEM	POSSIBLE CAUSE	SOLUTION
Thermostat set improperly	Thermostat set too low	Set thermostat properly and ensure connections are not loose or corroded.
Boiler fires when thermostat jumped, but will not fire with thermostat in circuit	Thermostat bad	Replace Thermostat.
Boiler will not fire when thermostat jumped	Problem elsewhere in system	Continue with boiler control diagnostics. If boiler still does not fire, the thermostat may need replaced.

BOILER SYSTEM DIAGNOSTICS - High Temperature Limit

PROBLEM	POSSIBLE CAUSE	SOLUTION
Electrical continuity through switch	Connections loose or corroded	Check connections to high temperature limit switch to ensure that they are not loose or corroded.
	Problem elsewhere in system	If there is continuity through the switch but the boiler still does not fire, there is a problem elsewhere in the system. Continue with boiler control diagnostics.
No continuity through switch	Switch bad	Replace switch.

BOILER SYSTEM DIAGNOSTICS - Low Fuel Shut-Off

PROBLEM	POSSIBLE CAUSE	SOLUTION
Fuel level low	Switch may be operating properly	Add fuel and retest.
Fuel level proper	Level sensor stuck	Check level sensor for proper movement. Clear, repair, or replace sensor assembly.
	Reed switch bad	Check level sensor for proper action. Replace switch if needed.

Free Manuals Download Website

<http://myh66.com>

<http://usermanuals.us>

<http://www.somanuals.com>

<http://www.4manuals.cc>

<http://www.manual-lib.com>

<http://www.404manual.com>

<http://www.luxmanual.com>

<http://aubethermostatmanual.com>

Golf course search by state

<http://golfingnear.com>

Email search by domain

<http://emailbydomain.com>

Auto manuals search

<http://auto.somanuals.com>

TV manuals search

<http://tv.somanuals.com>