

OPERATOR'S MANUAL



CHIPPER/SHREDDER

- SH-3000
- SH-5000 Serial Number E081543 & UP
- SH-8000 Serial Number E081543 & UP
- SH-8000 E Serial Number E081543 & UP
- SH-8000 I.C. Serial Number E081543 & UP
- SH-8000 R. Serial Number E081612 & UP

WARNING ▲ DANGER

READ INSTRUCTIONS CAREFULLY AND FOLLOW
RULES FOR SAFE OPERATION. FAILURE TO DO SO
COULD RESULT IN SERIOUS INJURY.

ECHO®

INTRODUCTION

Thank you for your purchase of an Echo Chipper/Shredder- a rugged machine of exceptional quality. Echo Chipper/Shredder models SH 3000, SH 5000 and SH 8000 are designed for shredding or chipping organic materials of a specified nature and size.

This manual provides the information necessary for safe and efficient operation and service. For your safety, it is critically important that you read and understand this entire manual before operating your Chipper/Shredder.

WARNING ▲ DANGER

Improper use or care of this unit, or failure to wear proper protection can result in serious injury. Read and understand the rules for safe operation and all instructions in this manual. Wear eye and hearing protection.

SERVICE ASSISTANCE

CHIPPER/SHREDDER

Contact an authorized Echo dealer and have your Serial Number available. (The location is shown in the Description Section .)

ENGINE

Contact authorized engine dealer. Dealers are listed in the yellow pages under "Engines, Gasoline" or "Gasoline Engines". Your dealer will need to know the model and serial number of your engine. For their location, please consult the Operator's Manual provided with your engine.

CONTENTS

	Page No.
Introduction	i
Safety and Special Information	1
Safety	2
Description	7
Decals	8
Operation	10
Troubleshooting	14
Service	15
Assembly	19
Storage	23
Specifications	25
Warranty	26

Specifications, descriptions and illustrative material in this literature are as accurate as known at the time of publication, but are subject to change without notice. Illustrations may include optional equipment and accessories, and may not include all standard equipment.

SAFETY AND SPECIAL INFORMATION

WARNING DANGER

This symbol is used to call attention to procedures that must be followed to avoid the risk of serious, immediate and irreversible human injury or death.

IMPORTANT

Indicates a situation that may cause damage to equipment.

NOTE

Draws attention to special information.

- Read and understand the entire Operator's Manual before using this machine.
- Follow all danger warnings in this manual.
- Locate the safety decals on your Chipper/Shredder. Make sure they are legible and that you understand and follow them. See pages 6, 7 & 8 for location of decals.

IMPORTANT

CALIFORNIA OWNER/OPERATORS

Under California Law, you are not permitted to operate an internal combustion engine using hydrocarbon fuels on any forest covered, brush covered or grass covered land; or on land covered with grain, hay or other flammable agricultural crop without an engine spark arrestor muffler in continuous effective working order. The engine on your Chipper/Shredder, like most garden equipment, is an internal combustion engine that burns gasoline(a hydrocarbon fuel). The engine is not equipped with a spark arrestor muffler; therefore it must be equipped by the purchaser with a spark arrestor muffler in proper working order.

The spark arrestor muffler must be attached to the engine exhaust system in such a manner that flames or heat from the system will not ignite flammable material. Failure of the operator to comply with this regulation is a misdemeanor under California Law.

SAFETY

WARNING DANGER

This symbol applies to all information in this safety section.

GENERAL

1. CONTACT WITH ROTATING CUTTING BLADES INSIDE DISCHARGE OPENING WILL CAUSE SERIOUS PERSONAL INJURY! CUTTING BLADES ARE ROTATING WHILE MACHINE IS RUNNING, AND SLOW DOWN GRADUALLY AFTER ENGINE IS SHUT OFF.
2. KEEP HANDS, FEET, FACE AND CLOTHING OUT OF SHREDDER HOPPER INLET AND CHIPPER CHUTE INLET AND AWAY FROM THE DISCHARGE AREA AND MOVING PARTS AT ALL TIMES TO AVOID SERIOUS INJURY. BEFORE DOING MAINTENANCE OR SERVICE, SHUT OFF THE ENGINE, LET ALL MOVING PARTS STOP COMPLETELY, REMOVE KEY AND DISCONNECT THE SPARK PLUG WIRE AND NEGATIVE BATTERY CABLE.
3. MATERIAL CAN BE EJECTED FROM THE HOPPER TOWARD THE OPERATOR. FOLLOW ALL SAFETY INSTRUCTIONS REGARDING OPERATOR POSITION AND USE OF SAFETY PROTECTION. THIS PRODUCT CAN PULL YOU WITH A SUDDEN STRONG FORCE. BE ALERT SO THAT YOU CAN RELEASE MATERIAL THAT IS BEING CHIPPED OR SHREDDED.

SAFETY BEFORE STARTING THE ENGINE

1. Read and understand all safety instructions in this safety section. Failure to comply can result in serious personal injury or property damage. If you have questions, or are not completely sure about any of the information found here or elsewhere in this Manual, contact your Echo dealer or Echo Inc. for assistance before you operate your equipment.
2. Read and understand this Operator's Manual before attempting to operate your equipment.

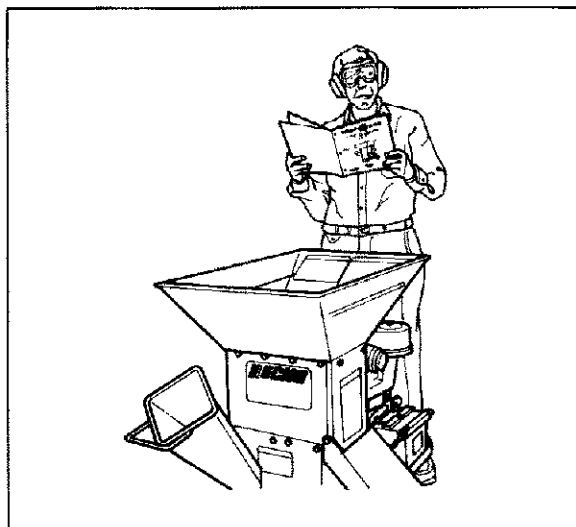

3. Know where the engine shut off control is and how to use it. On manual start models, this control is a switch on top of the engine. On electric start models, it's a key-operated switch just under the engine.
4. The operation of any powered machine can result in foreign objects being thrown by high speed rotating parts. Do not wear work gloves. Gloves can catch on material and you can be pulled into the moving parts. Wear sturdy footwear-not soft soled shoes. ECHO provides goggles that meet ANSI Z-87.1 requirements with this unit. Always wear eye protection when using this unit. Do not wear loose fitting clothing, jewelry, scarves, ties, etc. that can get caught in moving parts.

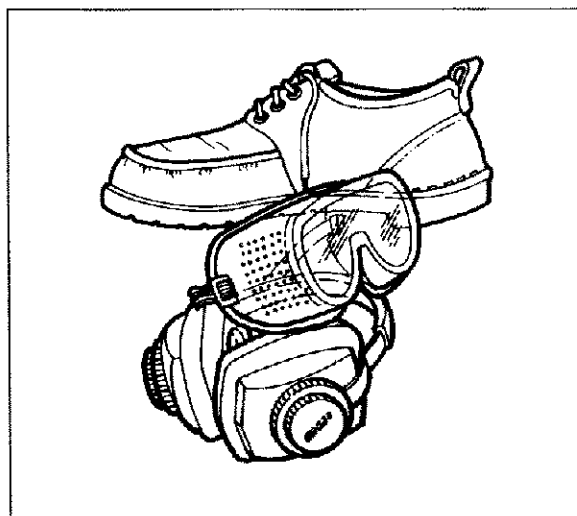

5. Always wear hearing protection when using this unit. Noise is created by the engine and the internal workings of the machine that chip or shred the material. See your ECHO dealer for ECHO ear inserts or ECHO ear protection muffs.
6. Do not allow anyone to use this unit unless instructions have been read and understood.
7. Never allow children under the age of 18 to operate this product or to play near the unit.

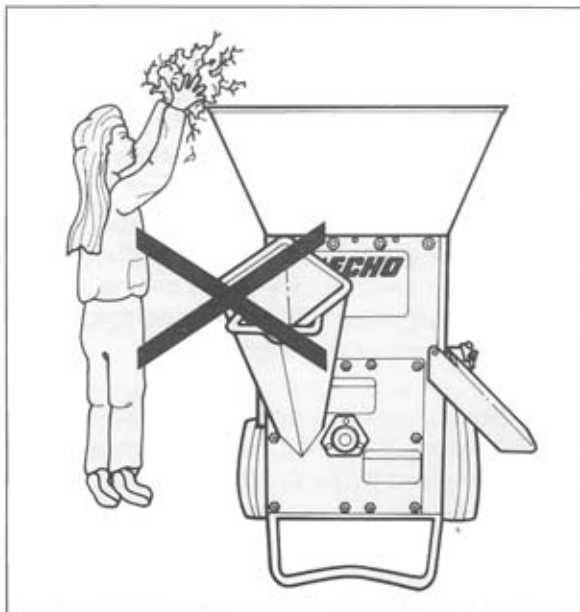

8. Do not operate the unit when under the influence of alcohol, medications or substances which can affect your vision, dexterity and judgement. You must be in good physical and mental condition in order to operate safely.
9. Gasoline and its vapors are highly flammable. Handle flammable fuel with care. Use an approved type of gasoline container. Use a long flexible spout when filling the gas tank. Do not smoke or bring sparks or flame near the fuel supply. Use proper fuelling procedure. Do not spill fuel. Wipe up fuel spills right away. Never refill the unit while the engine is running or hot. Make sure the engine is off and is allowed to cool for several minutes before refueling. Do not store the unit with fuel in the tank, because a fuel leak could start a fire.



10. Before starting the engine, make a visual check to see that all screws, nuts, bolts and other fasteners are properly secured and that all guards are in place. The Discharge Grate must be securely in place if being used. Disconnect the spark plug wire before performing this check. This visual check is recommended before each usage.
11. Before operating your equipment, be sure that the chipper chute, shredder hopper and internal cutting chamber are empty, and the service door is securely closed. The engine must be off, all moving parts completely stopped, and the spark plug wire disconnected before you do this.

SAFETY DURING OPERATION

1. Keep hands, feet, face and clothing out of shredder hopper inlet and chipper chute inlet and away from discharge area and moving parts to avoid serious injury.

WARNING DANGER

Always use the tamper provided to push material through the inlet guards. Do not use branches, sticks, rakes or other hard objects - they could whip violently and injure you.

2. Do not run engine in an enclosed area. The exhaust fumes from the engine contain extremely dangerous carbon monoxide gas. Carbon monoxide is colorless, odorless, tasteless and deadly poisonous.

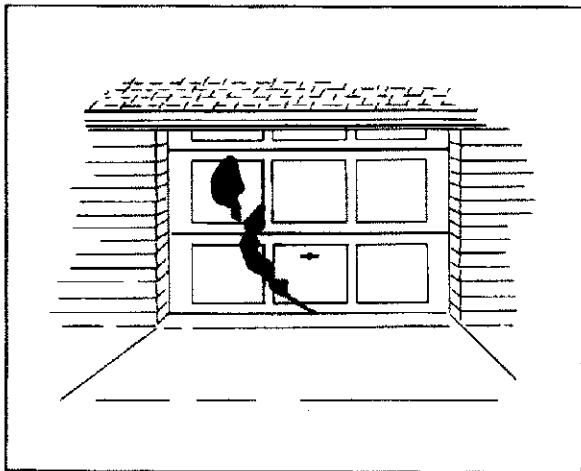

3. Do not operate your equipment when bystanders or pets are nearby. Keep bystanders at least 33 feet away from this equipment.

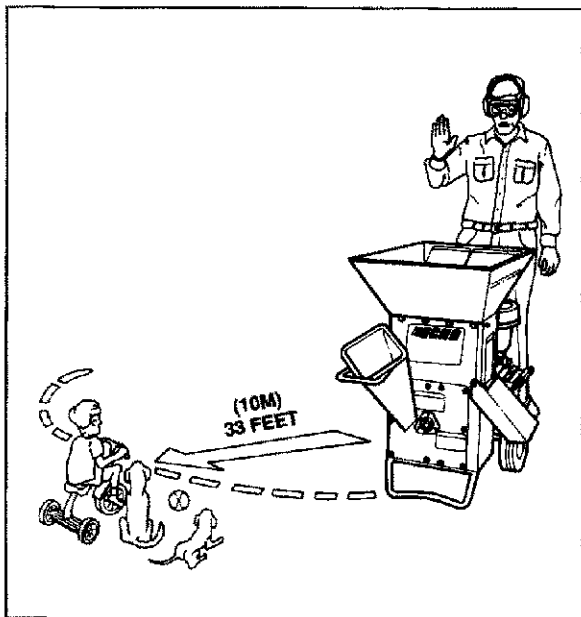

4. Do not operate the Chipper/Shredder on a paved or gravel surface. Discharged material may bounce from a hard surface and cause personal injury. Select a level, earthen surface.

5. Always stand clear of the Discharge Area when operating your equipment. Stand in the "Zone of Operation" shown in the illustration below.

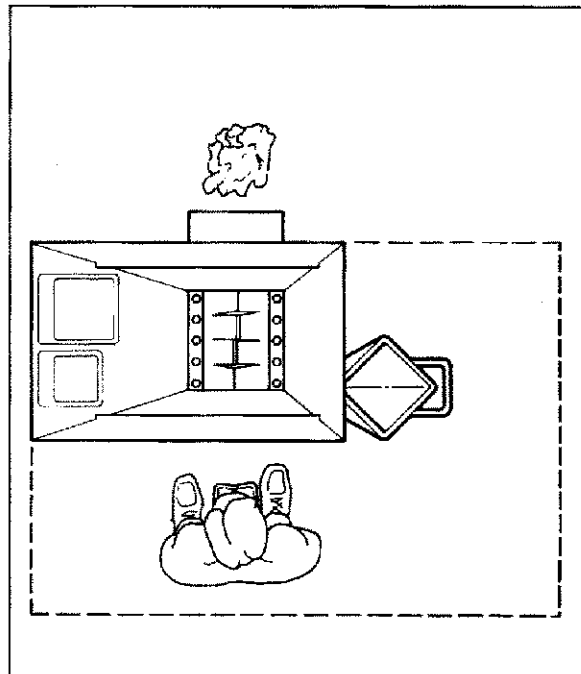

6. Do not put face, hands, feet, or any part of your body or clothing near the chipper chute, shredder hopper or discharge area. Cutting blades will begin to rotate and build up speed once the engine is running and clutch lever is moved up.

Once the blades are revolving, moving the clutch lever down alone will not stop the blades. To stop blade motion, move the throttle to a slow position, disengage clutch lever, move throttle until stopped. Cutting blades slow down GRADUALLY.

Under normal shut down circumstances (engine shut off and stopped), with the clutch lever in the down position, **operating blades will require up to sixty seconds to stop completely.** Do not assume blades have stopped. Be sure. Look at the drive shaft next to the chipper chute to see that it is motionless. Look for the white paint mark on the bearing collar. Injury can occur unless blades are completely stopped.

7. If chipper or shredder becomes jammed or clogged, shut the engine off and move the clutch lever down to prevent damage to chipper/shredder parts. **TO AVOID INJURY, MAKE SURE ALL MOVING PARTS HAVE COME TO A COMPLETE STOP.** Remove key, disconnect the spark plug wire and negative battery cable. Only then, inspect the shredder, hopper chute and discharge screen, and the internal chamber. **Remember, rotating blades can take sixty seconds or more to stop. Use only a wooden stick to clear away jammed material.**
8. When feeding appropriate material into the Chipper or Shredder, be extremely careful that pieces of metal, rocks, bottle, nails, cans and any other foreign objects are not included. Use organic materials only.
9. Do not allow the engine, especially around the cooling fins and muffler, to become clogged with leaves, oil, grease or any other combustible material. Keep these areas clean to avoid a potential fire hazard.
10. Do not allow chipped or shredded material to build up in, or clog the discharge tunnel or opening - clogging prevents proper discharge of materials and can result in kickback of material through the shredder hopper or chipper chute. In order to remove material from the discharge area, use a long handled shovel or long stick. Never use your hands or feet. Blades cut 1/4 inch from discharge screen. Keep away! Never put your hands or feet in the discharge opening.

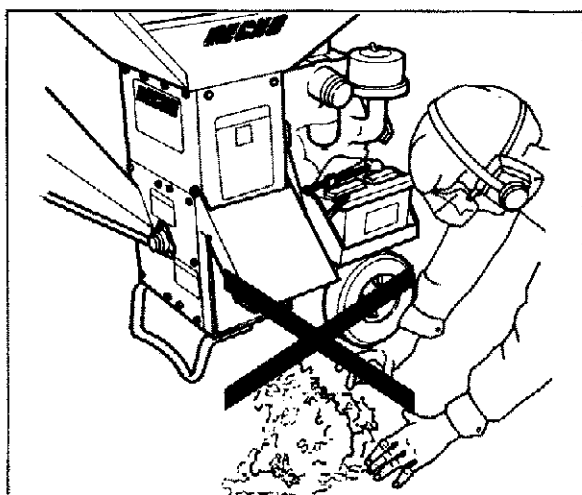

11. Do not overreach when feeding material into the hopper or chute. Keep proper footing and good balance at all times. Never put arms in hopper when shredding materials. When chipping, keep arms to the side of the chipper chute. Obey the safety and instruction decals on your equipment at all times.

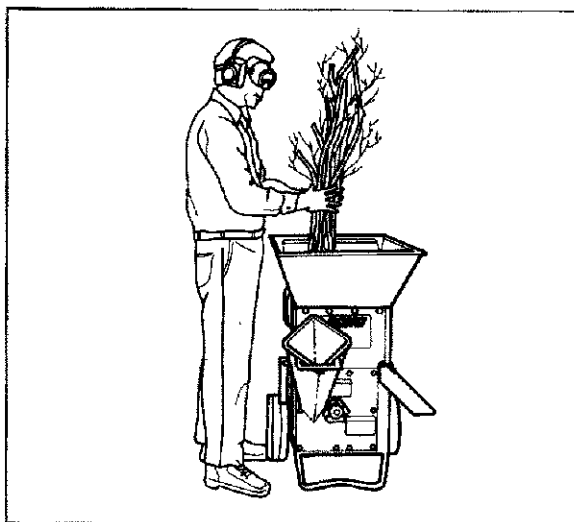

12. Always use the tamper provided to push material through the hopper inlet guards. Do not use branches, sticks or other hard objects - they could whip violently and injure you.
13. Do not transport or move your equipment while the engine is running.

SAFETY INSTRUCTIONS FOR SERVICE AND STORAGE

1. Before service, maintenance, cleaning, inspection, changing shredder discharge screens or work of any other kind is to be done, be sure the engine is stopped, all moving parts are still, the key is removed and the spark plug wire and negative battery cable are disconnected. If the engine had been running, allow the hot muffler to cool before working near it or installing a storage cover.
2. Store this equipment where children will not have access to it. Always remove the key and disconnect the spark plug wire and the negative battery cable.

3. Be sure the Chipper/Shredder is stored in an area where any gasoline vapors (fumes) from the engine can not reach an open flame, sparks, or flame-producing equipment such as a hot water heater pilot light, a woodstove or a furnace.
4. For seasonal storage, drain all gasoline from the fuel tank and dispose of it in a safe manner. Then run the engine until the small amount of gasoline left in the carburetor and fuel line has been used up. Remove the key and disconnect the spark plug wire and negative battery cable. Let the engine cool before storing.



DESCRIPTION



FEATURES AND CONTROLS

1. Shredder Hopper
2. Chipper Chute
3. Discharge Screen
4. Clutch Lever
5. Serial Number Location

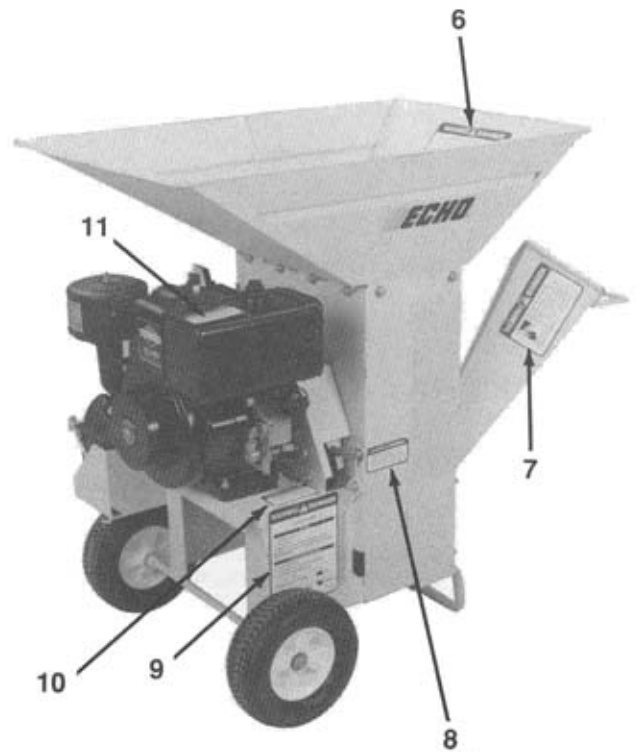

DECAL LOCATION



Note: Decals are shown on pages 8 & 9.

DECALS

WARNING  DANGER





Always use the tamper provided with the unit to push material through the inlet flaps into the hopper. Do not use sticks or rakes. Never use your hand to push material through the inlet flaps. Always wear eye protection which meets A.N.S.I. Z 87.1 standard. Goggles are provided with the unit.

999450-00210

1

999450-00210

WARNING  DANGER



- Rotating blades will cause serious personal injury.
- Keep hands and feet out of discharge opening and away from discharge area.
- Do not operate unless shield is properly in place. Blades coast to a stop. Keep bystanders at least 33 feet away.
- To avoid serious personal injury, stop engine, remove spark plug wire and allow machine to come to a complete stop before clearing obstructions or making adjustments.

999450-00170

3

999450-00170

WARNING  DANGER

- Read the operator manual before starting and using this equipment. If you need a replacement manual or decals, contact your Echo dealer or Echo, Incorporated, 400 Oakwood Road, Lake Zurich, IL 60047.
- Keep hands, feet, face and clothing out of shredder hopper inlet and chipper chute inlet and away from discharge area and moving parts to avoid serious injury.
- Keep hands and feet out of discharge opening when machine is running. Rotating cutting blades inside opening will cause serious personal injury.
- Wear ANSI approved safety goggles and ear protection.
- Do not wear loose fitting clothing, gloves.
- Wear durable footwear.

- Keep bystanders, children and pets at least 33 feet away from operating and discharge areas.
- If unit jams or becomes clogged, shut engine off right away and let all moving parts come to a complete stop. Disconnect the spark plug wire. Use only a wooden stick to clear away discharged material or blockage.
- Keep all shields and service door in place and securely attached.
- Do not use hands or feet to clear material from the discharge area.
- Do not install parts, or remove, adjust or service the discharge screen or any other part while the machine is running. Do not operate unit on uneven ground or on a paved, gravel or hard surface. Do not run engine in an enclosed area – exhaust gas contains poisonous carbon monoxide fumes.

TO START

1. MOVE ENGINE CHOKE LEVER TO "FULL CHOKE" POSITION. IF ENGINE HAS ALREADY BEEN RUNNING, DO NOT USE CHOKE LEVER.
2. MOVE ON/OFF SWITCH TO "ON" POSITION.
3. MOVE CLUTCH LEVER ALL THE WAY DOWN.
4. PULL START ROPE OUT FIRMLY TO START ENGINE. ON ELECTRIC START MODELS, TURN KEY TO START POSITION. MOVE ENGINE CHOKE LEVER TO "PARTIAL CHOKE" POSITION ONCE ENGINE STARTS. AFTER A FEW SECONDS, MOVE CHOKE LEVER TO "NO CHOKE" POSITION.
5. SLOWLY MOVE CLUTCH LEVER UP TO TRANSFER POWER TO THE INTERNAL ROTATING CUTTING BLADES.

TO STOP

1. MOVE ON/OFF SWITCH TO "OFF."
2. KEEP CLUTCH LEVEL UP UNTIL ALL MOVING PARTS HAVE COME TO A COMPLETE STOP.

999450-00160

2

999450-00160

WARNING  DANGER

**Rotating cutter blades.
Do not operate unless
discharge screen is
bolted in place.**



999450-00180

999450-00180

4

WARNING  DANGER

If this shaft is turning, rotating blades can injure. Look at white mark on the bearing.



999450-00190

5

999450-00190

Note: For location of decals, see page 7.

WARNING DANGER

Risks / Serious Injury - Violent reaction may occur

PULL IN - Branches may be quickly pulled by moving blade. Stubs on branches can catch on gloves, clothing, etc. and can pull hand into machine.

WHIPPING - Blade may cause violent whipping of material. Do not use rakes or sticks to push material into hopper. Use tamper supplied with unit.

THROWN OBJECTS - Pieces of material can be thrown back at operator or bystander. Stay in operator zone. Wear eye protection.

CLOGGING - Feeding oversized or excessively wet material will jam rotor blades and clog machine. Be sure blade has come to a complete stop, shut ignition, remove spark wire before clearing clog.

INLET FLAPS - Do not use the unit unless inlet flaps are in position. If flaps are broken or missing, do not use the unit until they are replaced.

999450-00150

6

999450-00150

WARNING DANGER

CLUTCH LEVER

TO USE

1. Move lever down.
2. Start engine.
3. Slowly move lever up to make blades rotate.

IMPORTANT: MOVING LEVER DOWN WILL NOT STOP BLADE MOTION.

TO STOP BLADE MOTION

1. Lever must be up.
2. Shut engine off - blades slow gradually.
3. Let all parts completely stop.

To engage power to shredder:  UP

To disengage power to shredder:  DOWN

999450-00220

9

999450-00220

WARNING DANGER



ROTATING CUTTING BLADES

Keep hands and feet out of inlet and discharge opening while machine is operating. To avoid serious personal injury, stop engine, remove spark plug wire allow machine to come to a complete stop before clearing obstruction or making adjustments.

999450-00230

7

999450-00230

WARNING DANGER

Do not start engine unless belt cover is securely attached. Failure to comply could result in personal injury from moving belt and pulleys. See operator manual for full safety and maintenance instructions.

999450-00250

10

999450-00250

WARNING DANGER

If you need replacement manual or decals, contact your ECHO dealer or ECHO, INCORPORATED, 400 Oakwood Road, Lake Zurich, Illinois 60047.

999450-00240

8

999450-00240

WARNING DANGER

To avoid a fire, keep leaves, grass and other combustible materials away from hot engine muffler. Always wipe up fuel spills. Do not start within ten feet of fueling location. Use long neck flexible fuel filler spout.

999450-00200

11

999450-00200

Note: For location of decals, see page 7.

OPERATION

HANDLING FUEL

WARNING **DANGER**

Handle fuel carefully. It is extremely flammable. Follow all rules listed below to help prevent fire or explosion which may result in severe injury or death.

- Never smoke or allow flame or sparks near fuel.
- Always fill fuel tank outdoors. Never pour fuel indoors.
- Never refuel engine when it is hot or running.
- Always use an approved, safe fuel container.
- Use a long flexible spout when filling the gas tank.
- After fuelling, always wipe up spilled fuel.
- Do not overfill the tank. Always move at least 10 feet away from the fuelling spot and make sure there is no fuel leakage before starting the engine.

- Never store the Chipper/Shredder with fuel in the tank - a fuel leak could start a fire.
- Always remove the fuel cap slowly to relieve any pressure buildup in the tank.
- Always tighten fuel caps on Chipper/Shredder and on fuel container.



SHREDDING AND CHIPPING GUIDELINES

Shredding—through the hopper

- Try small amounts of material at first.
- Softer materials such as lawn and garden debris (leaves, grass clippings, cornstalks, plants, short sections of vines, etc.) are relatively easy to shred.
- Sticks and branches should be no more than 3/4" in diameter or 2' long to avoid whipping and wrapping.
- Wet material is easier to process if it is mixed with dry material and the discharge grate with the largest holes is used.

- Newspapers, milk cartons and other paper material may be shredded.
- Processed material may be used as compost or mulch.

Chipping—through the inlet chute

- Branches up to 3" in diameter may be chipped, depending on model.
- Smaller branches can be combined and fed into the chute together.
- Chip size can be varied by changing the discharge grate.
- Processed chips can be used as compost or as decorative mulch.

STARTING

WARNING **DANGER**

Read and understand all safety information in the Safety Section (pages 2-6) before starting this machine.

1. Move engine choke lever to "full choke" position. If engine has already been running, do not use choke.
2. Move on-off switch to "on" position.
3. Move clutch lever all the way down.



4. Pull start rope out firmly to start engine. On electric start models, turn key to start position, move engine choke lever to "partial choke" position once engine starts. After a few seconds, move choke lever to "no choke" position.



5. Slowly move clutch lever up to transfer power to the internal rotating cutting blades.

NOTE

If you move the clutch too quickly, the engine will stall and stop.

STOPPING

1. Move on-off switch to "off".
2. Keep clutch lever up until all moving parts have come to a complete stop.
3. Move clutch lever down.

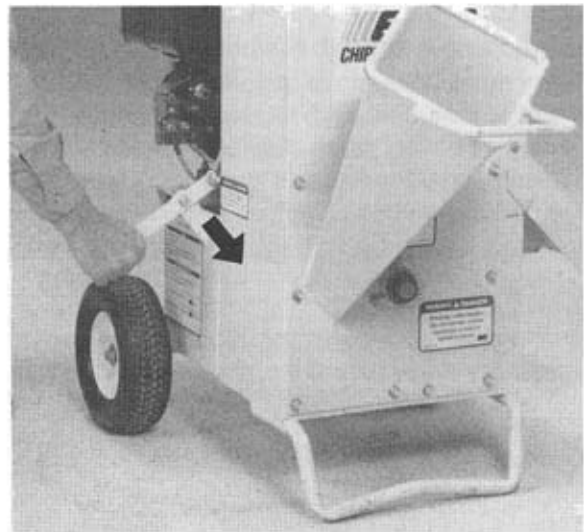

CHIPPING AND SHREDDING

Shredding

WARNING **DANGER**

Do not overreach when feeding material into the hopper. Keep proper footing and good balance at all times. Never put arms in hopper when shredding materials. Obey the safety and instruction decals on your equipment at all times.

WARNING **DANGER**

Do not operate the shredder with the inlet guard removed. This inlet guard limits the ability of the unit to throw objects up toward the operator. If the inlet guard flaps become worn or broken, they must be replaced. Do not use the unit without the inlet guards securely in position and in good repair. Injury to the operator can occur.

IMPORTANT

Sticks and branches should be no more than 3/4" in diameter or 2' long to avoid whipping and wrapping.

1. Place material to be shredded into hopper.

WARNING **DANGER**

Always use the tamper provided to push material through the inlet guards. Do not use branches, sticks, rakes or other hard objects - they could whip violently and injure you.

2. Feed material evenly into shredder so that engine does not lug and the shredder does not clog.

NOTE

Feed items that tend to clog the machine more slowly or into the chipper chute.



Chipping

WARNING DANGER

Do not overreach when feeding material into chute. Keep proper footing and balance at all times. When chipping, keep arms to side of chipper chute. Obey the safety and instruction decals on your equipment at all times.

IMPORTANT

See Specification Section page 24 for size of branches that your model can handle.

1. Trim small side branches off limbs.
2. Place butt (large) end of a single limb or small bunches of smaller limbs into chipper chute until chipping blades are contacted.



3. Feed continuously or intermittently, while rotating the limb(s).

NOTE

Feed rate will vary with the type of material, sharpness of cutting blades and the size of the machine.

Bagging

WARNING DANGER

Do not allow processed material to build up in the discharge area. This may prevent proper discharge and can result in kickback of material through the feed opening.

1. Loop the top of a large, heavy-duty trash bag over the discharge chute and hold the bottom with the front leg.

WARNING DANGER

Maintenance and service should only be performed after the engine is off, the key is removed, the spark plug wire and the negative battery cable are disconnected, and all moving parts have come to a complete stop. Check that the white paint mark on bearing collar has stopped moving.

2. Stop the machine frequently, remove the bag and check that discharge area is clear and move the material to the bottom of the bag.



Discharge Grates

NOTE

Chipped or shredded material must pass through holes in the discharge grate. Three grates are available with hole sizes 3/8", 3/4" and 1 1/2". (standard) The size of the chipped or shredded material will vary depending on the grate used.

TROUBLESHOOTING

Problem	Probable Cause	Suggested Remedies	Ref.
1. Engine will not start	A) Improper control settings B) Lack of fuel C) Internal problems	A) Use proper setting B) Fill fuel tank C) See your dealer	Engine Manual Engine Manual
2. Engine and rotor stalls or stops	A) Obstructed discharge B) Plugged rotor	A) Use branch or similar object to clear discharge B) Clear rotor	Service Section Service Section
3. Hard to feed chipper or excessive power needed to chip	A) Obstructed discharge B) Dull chipper knives C) Improper knife clearance	A) Use branch or similar object to clear discharge B) Sharpen knives C) Adjust clearance	Service Section Service Section Service Section
4. Shredder requires excessive power or stalls	A) Obstructed discharge B) Plugged rotor C) Green material will not discharge	A) Use branch or similar object to clear discharge B) Clear rotor, feed material into shredder more slowly C) Alternately feed dry material, or install discharge screen with larger holes	Service Section Service Section Operation & Service Section
5. Engine stalls or belt squeals when engaging clutch	A) Engagement too fast B) Plugged rotor	A) Lift clutch lever more slowly B) Clear rotor	Operation Section Service Section
6. Material from chipper wraps around rotor shaft	A) Stringy, green material bypasses chipper knife B) Improper knife clearance	A) Rotate material while chipping B) Adjust clearance	Operation Section Service Section

SERVICE

WARNING DANGER

Contact with internal rotating cutting blades will cause serious personal injury. Do not put hands, face, feet or clothing into the shredder hopper, chipper chute, discharge opening or near the discharge area at any time.

Maintenance and service should only be performed after the engine is off, the key is removed, the spark plug wire and negative battery cable are disconnected, and all moving parts have come to a complete stop. Check that the white paint mark on driveshaft has stopped moving. Use only a wooden stick to clear jammed material after all moving parts have stopped completely.

ENGINE

NOTE

For engine service procedures, follow recommendations in the Engine Operator's Manual supplied.

1. Check or change engine oil.
2. Service air cleaner.

CHIPPER/SHREDDER

NOTE

Sharpen knives when it becomes difficult to feed limbs or takes extra power to make chips.

Sharpen Chipper Knives

1. Remove discharge screen.
2. Rotate rotor until knife mounting bolts are accessible and remove bolts.

IMPORTANT

Avoid overheating blade when sharpening - it will lose its heat treated properties.

WARNING DANGER

When grinding always wear goggles that meet ANSI Z87.1 requirement to protect eyes.

3. Grind edge of blade to 45°, grinding a little at a time and cooling with water. See your local Echo dealer if not familiar with grinding.

NOTE

Remove the same amount from each blade to keep them balanced.

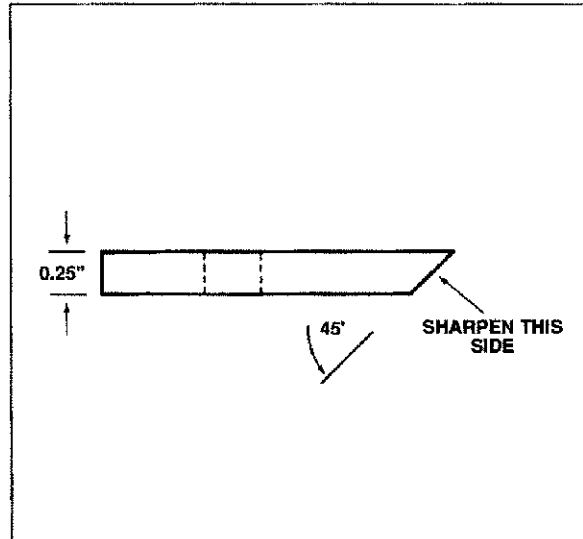

4. Install blades using correct bolts (5/16 - 18 x Gr 5). **Do not oil threads of bolt.** Tighten bolts to 18-20 ft. lbs.

IMPORTANT

Do not overtighten bolts. Over tightening stretches the bolts allowing them to loosen.

Adjusting Knife Clearance

NOTE

Clearance between chipping knives and chipping blocks is 1/16" to 1/8".

1. Remove lower belt guard and discharge screen.
2. Loosen set screws holding lock collars on front and rear rotor bearings.
3. Loosen lock collars using a punch and hammer until they can be turned and removed.

4. Tap end of rotor shaft with rubber mallet until clearance between knife and chipping block is 1/16" to 1/8" for each knife.
5. Reinstall lock collars. Turn collar in direction of shaft rotation using a punch and hammer. Tighten set screws.
6. Check pulley alignment, using a straightedge. If necessary, loosen set screws on both pulleys and move them so that they are in line. Make sure that idler pulley contacts the center of the belt. Retighten set screws.
7. Install lower belt guard and discharge screen.

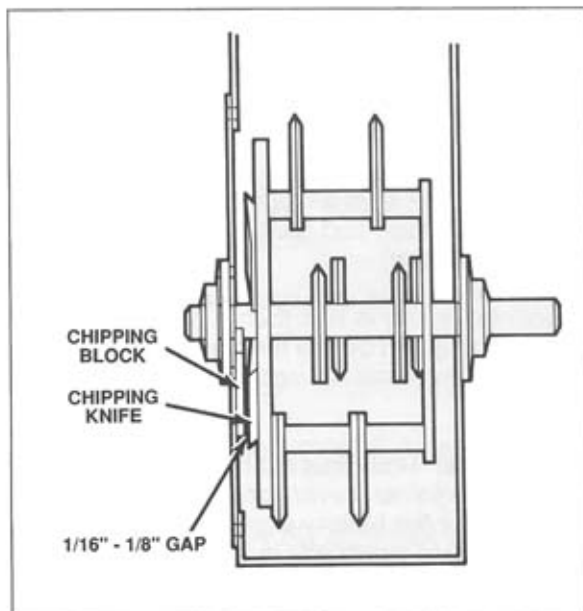

SHREDDER KNIVES

NOTE

The serrated self sharpening shredder knives are designed to offer long life and can be reversed if they become dull. To have sections reversed, see your authorized Echo Service Dealer.

CLEANING PLUGGED ROTOR

NOTE

Rotor will plug with material that is too large for shredding or by trying to shred too much material too fast.

1. Remove discharge screen. (See Changing Discharge Screens in this Section .)

2. Remove debris and turn rotor to make sure it turns freely.
3. Install discharge screen.

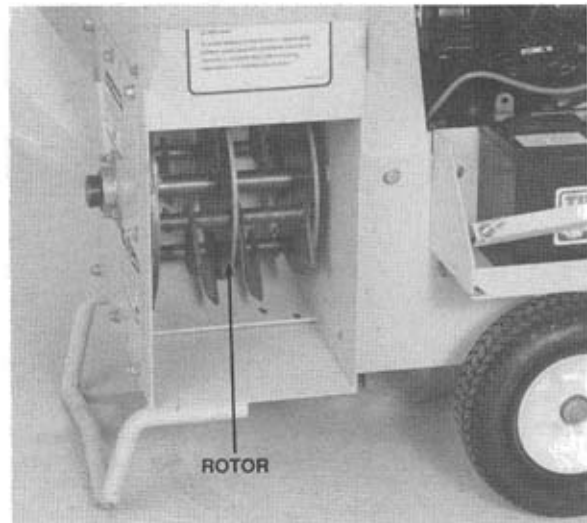

REPLACING DRIVE BELT

1. Remove the spark plug wire.

NOTE

Check condition of drive belt annually or after every 30 hours of use, whichever comes first. Replace belt if it is cracked, frayed or worn.

2. Remove upper and lower belt guards.
3. Slip drive belt from pulleys.

NOTE

If necessary, loosen engine bolts and tip engine forward to allow belt to slip over pulley.

4. Inspect pulleys for wear. Replace pulleys if they are cracked, or if belt contact area is not smooth.

IMPORTANT

Do not force or pry belt over pulley - this will cause cord breakage. Loosen engine mounting bolts and tip engine forward to allow belt to slip over pulley.

5. Place new belt over pulleys.
6. Align engine so that crankshaft is parallel to rotor shaft. Tighten engine mounting bolts to 20 ft. lbs.

7. Check pulley alignment, using a straightedge. If necessary, loosen set screws on both pulleys and move them so that they are in line. Make sure that idler pulley contacts the center of the belt. Retighten set screws.

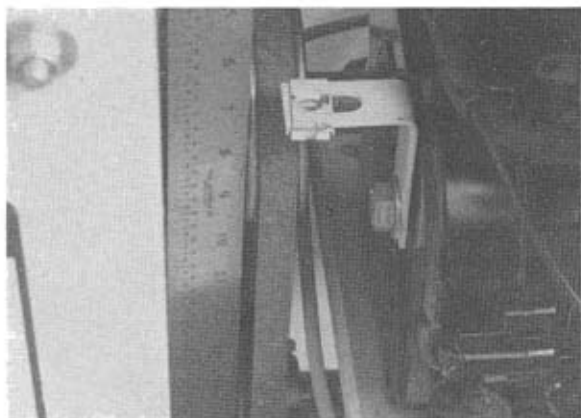

8. Install lower and upper belt guards and make sure all bolts nuts and fasteners are tightened to 20 ft. lbs.

CHANGING DISCHARGE SCREENS

NOTE

Discharge screens are available with different size holes. See Specifications Section.

1. Remove spark plug wire.
2. Remove nut and bolt holding discharge screen from bottom center of shredder frame.
3. Remove screen.
4. Reinstall screen nut and bolt and tighten to 20 ft. lbs.



BATTERY

WARNING DANGER

- Wear eye protection to keep corrosion from coming in contact with eyes.
- Gases around the battery are explosive. Always keep spark and flame away from battery.
- Never smoke in vicinity of battery.

Testing and Service

NOTE

A complete battery test includes cleaning the top of the battery case, cleaning terminals and cable clamps, and performing hydrometer and heavy load tests.

General. The condition of a battery is determined by testing state of charge (hydrometer test) and ability to deliver current (heavy load test).

If specific gravity is less than 1.225, the battery must be charged before further testing. A battery which does not accept a charge is defective.

Hydrometer Test. Inspect battery for damage (broken container, cover, loose post, etc.) that would make the battery unserviceable. Position top surface of electrolyte in hydrometer at eye level. Disregard curvature of liquid where surface rises against float due to surface tension. Draw in only enough electrolyte to keep the float off the bottom of hydrometer barrel with the bulb released. The hydrometer must be kept vertical while drawing in liquid and taking the reading.

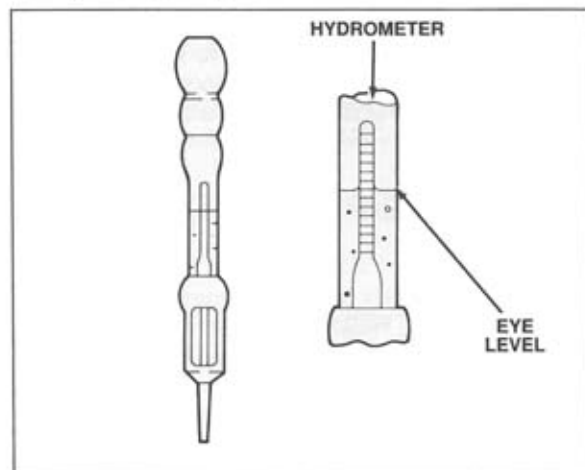

CAUTION

Care should be taken when inserting the tip of the hydrometer into the cell to avoid damage to separators. Broken separators could result in premature battery failure.

Hydrometer floats are generally calibrated to read correctly at 80°F. When taking a reading at any other temperature, a correction factor must be used. The correction factor is approximately 0.004 specific gravity, referred to as 4 points of gravity. For each 10°F below 80°F, subtract 4 points. Always correct the readings for temperature variation. Test the specific gravity of the electrolyte in each battery cell.

Example. A battery is tested at 10°F and has a specific gravity of 1.240. The actual specific gravity is found as follows.

Number of degrees above or below 80°F equals 70° (80° - 10°).

70 divided by 10 (each 10° difference) equals 7.

7 x 0.004 (temperature correction factor) equals 0.028.

Temperature is below 80° so temperature correction is subtracted.

Temperatures corrected specific gravity is 1.212 (1.240 minus 0.028).

A fully charged battery should have a specific gravity of 1.250 to 1.265.

Specific Gravity

State of Charge (Cold and Temperate Climates)	Specific Gravity
Fully Charged	1.265
75% Charged	1.225
50% Charged	1.190
25% Charged	1.155
Discharged	1.120

If the specific gravity of all cells is above 1.235, but the variation between cells is more than 50 points (0.050), it is an indication of an unserviceable battery. The unit should be removed for further testing.

If the specific gravity of one or more cells is less than 1.235, recharge the battery at approximately 5 amperes until 3 consecutive hourly readings are constant.

At the end of the charge period, if the cell variation is more than 50 points (0.050), replace the battery.

When the specific gravity of all cells is above 1.235 and variation between cells is less than 50 points, the battery can be tested under load.

Heavy Load Test. This test is performed to make sure the battery can deliver current under load.

1. Connect battery tester to the battery and follow the manufacturer's instructions.
2. Discharge the battery under a fixed load, at three times the ampere-hour rating for approximately 15 seconds, then read the terminal voltage.
3. If the battery is in satisfactory condition, the terminal voltage reading should remain above 9 volts.
4. If the terminal voltage falls below this value, the battery is either defective or it is not fully charged.

NOTE

To be sure of the battery condition, carefully charge it and repeat the test.

5. Replace the battery if it is defective.

ASSEMBLY

WARNING DANGER

Remove key, disconnect spark plug wire and negative battery cable before carrying out any assembly procedures to avoid accidental starting and serious injury.

WARNING DANGER

To avoid serious injury remove discharge screen and remove any bolts dropped into hopper.

HOPPER

1. Place hopper on frame with longer end of hopper over engine and tabs of hopper inside frame.
2. Loosely install bolts, washers and nuts with bolt heads on inside. (There are four on each end and two on each side.)
3. Tighten all bolts to 20 ft. lbs.

IMPORTANT

1. Inspect entire machine to ensure that all fasteners are tight.

WARNING DANGER

Check that all guards are in place and securely fastened. Operating the machine with loose or missing guards could cause serious injury.

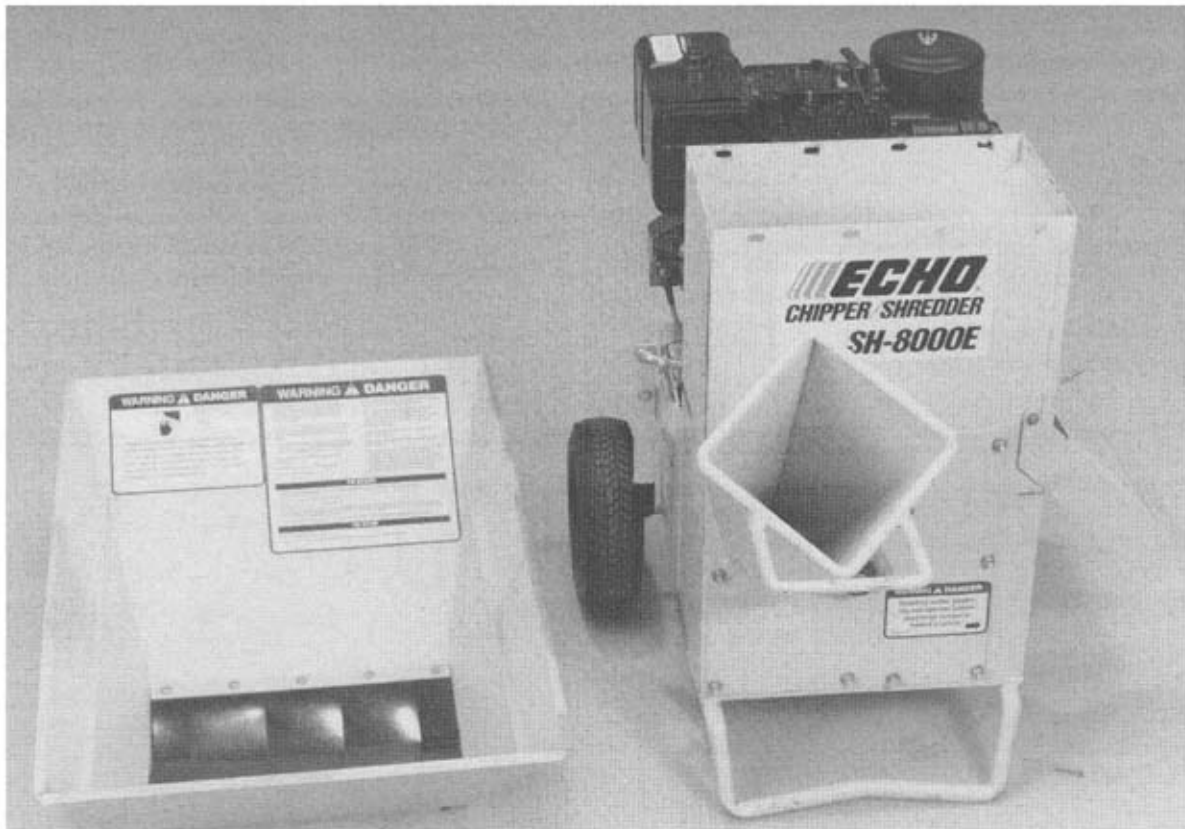

BLOWER ATTACHMENT (OPTIONAL)

WARNING **DANGER**

Disconnect spark plug before working on machine.

Blower attachments can be used only on 5 H.P. and 8 H.P. units.

1. Remove all blower parts from shipping packages.
2. Remove rotor shaft end cap.

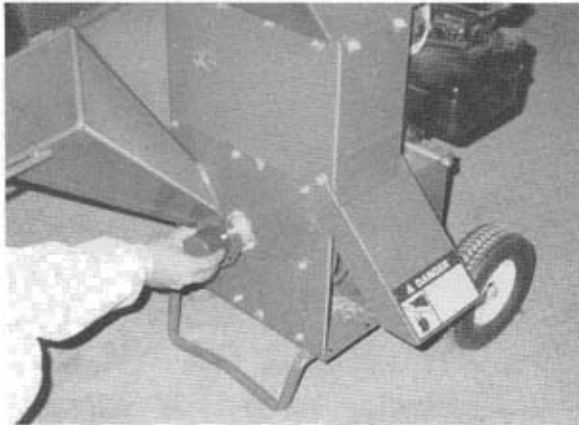

3. Install 1/4" x 2" key and 3" pulley on rotor shaft. Do not tighten pulley set screws.

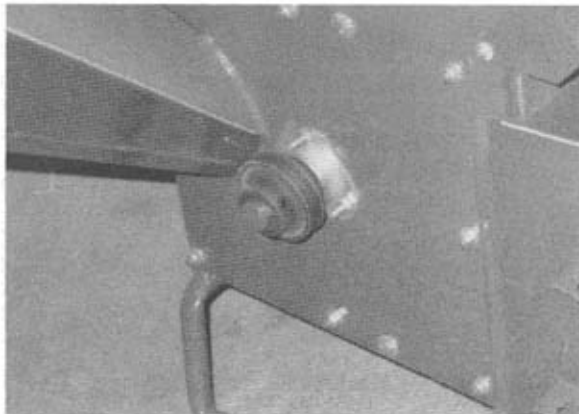

4. Install blower attachment weldment to Chipper/Shredder. Lift discharge door and slide blower assembly onto frame using slots provided. Install pegs in holes in Chipper/Shredder frame on bottom of blower.

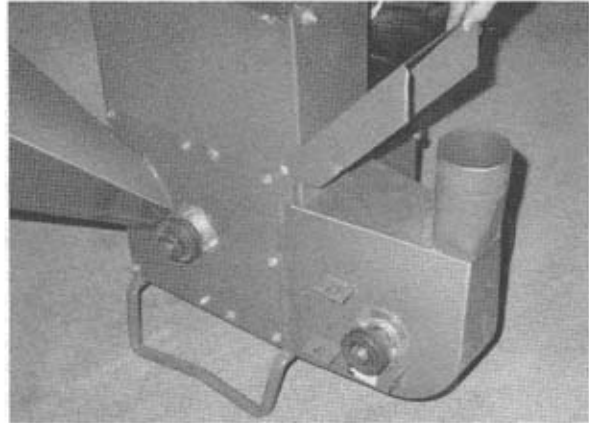

5. Install drive belt. Align rotor shaft pulley and blower assembly pulley. Tighten all pulley set screws.

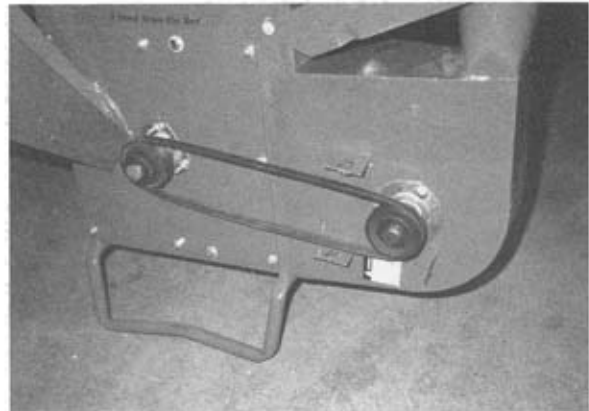

6. Install belt guard onto blower attachment with three 5/16" x 3/4" bolts and three 5/16" washers.

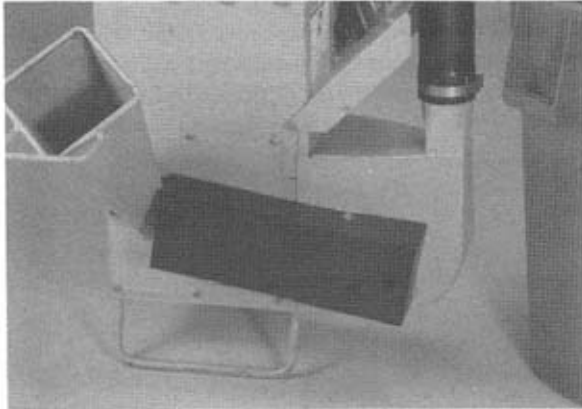

7. Install blower spout on blower tube using two 5/16" x 3/4" bolts - two 5/16" flat washers, one spout knob and one locking nut.

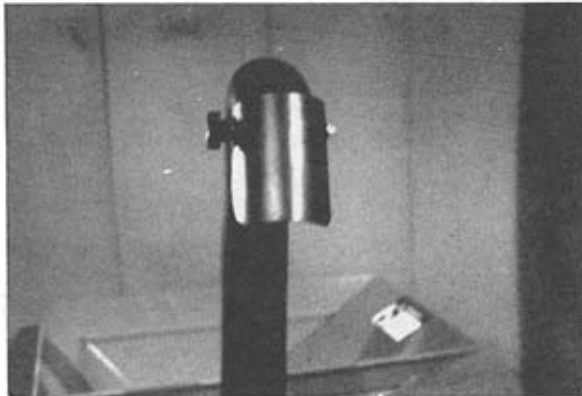

8. Install blower tube onto blower assembly. Fasten with t-bolt clamp.

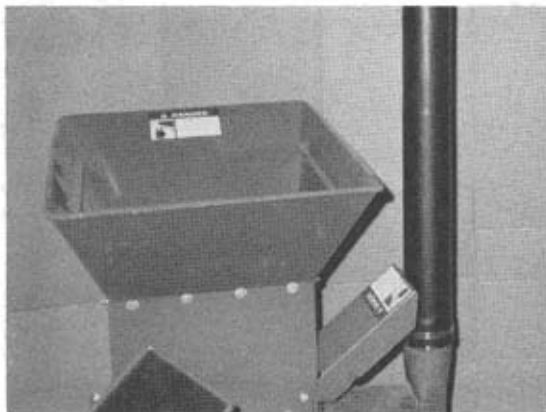

BATTERY

Description. See Specification Section for correct battery. Prior to putting a new dry-charged battery in service it must be activated.

NOTE

Always store batteries and acid in a dry area at 60°F to 90°F.

Activation Procedure

WARNING ⚠ DANGER

Before activating a dry-charged battery, carefully read the instructions and **POISON/DANGER WARNING** on the electrolyte carton.

1. Place battery on level surface. Remove vent caps. Fill each cell with battery electrolyte to bottom of vent well, observing handling precautions listed on electrolyte carton.

WARNING ⚠ DANGER

- Gases in and around the battery during charging are explosive. Always keep spark and flame away from battery. Do not smoke around charging battery.
- To prevent injury from explosion or fire, never charge frozen battery.

2. After cells are filled, tilt battery from side to side to release air bubbles.
3. Recheck electrolyte level in each cell and add as necessary.

NOTE

Uneven filling of cells will affect the battery capacity and service life.

4. Install vent caps supplied with battery.
5. Check battery case for leakage to make sure no damage occurred in handling.
6. Slow charge battery until fully charged. Battery temperature should not exceed 125°F.

7. Install battery:

- A. Make sure that red positive lead is connected to positive post and that black negative lead is connected to negative post.
- B. Install mounting bracket over outer edge of battery, install mounting rods and secure tightly with nuts so that battery cannot move.



NOTE

Since the level of charge of the battery as read by a hydrometer is depressed after the first few starting cycles, load testing is the only valid test at the time of activation. (See Load Test in Service Section). Hydrometer testing may be used after the battery has been cycled in service.

The specific gravity of a newly installed battery will be approximately 1.225.

The specific gravity will normally rise to 1.250 to 1.265 after a few days in service.

NOTE

Electrolyte is made up of sulfuric acid and pure water. Approximately 35 percent by weight or 24 percent by volume is acid.

WARNING ⚠ DANGER

Never add pure sulfuric acid to a battery.

Slow Charge. Slow charging is the preferred method of charging a battery. The slow charge method may be safely used, regardless of charge condition of the battery, provided the electrolyte is at the proper level in all cells and is not frozen.

WARNING ⚠ DANGER

Do not attempt to charge or use a booster on battery with frozen electrolyte as it can cause the frozen battery to explode.

The normal charging rate for a battery is one amp per positive plate per cell. A minimum period of 24 hours is required when using this method.

A battery is in a maximum charged condition when all cells are gassing freely and three corrected specific gravity readings, taken at hourly intervals, indicate no increase in specific gravity.

WARNING ⚠ DANGER

Always disconnect the battery cables before using a fast charger.

Fast Charge. A battery may be charged at any rate which does not cause the electrolyte temperature of any cell to exceed 125°F (51.7C) and which does not cause loss of the electrolyte.

A fast charger cannot be expected to fully charge a battery within an hour but will charge the battery sufficiently so that it may be returned to service.

STORAGE

SHORT TERM STORAGE (90 DAYS OR LESS)

WARNING ▲ DANGER

Store Chipper/Shredder in a dry place, out of reach of children. Do not store in an enclosure where fuel fumes may accumulate or reach an open flame or spark.

1. Clean exterior of Chipper/Shredder to remove all accumulations of grease, oil, dirt or debris.
2. Perform any periodic lubrication or services as required.
3. Tighten all cap screws and nuts.
4. Touch up paint as required.
5. Remove spark plug cable to prevent accidental starting.
6. Place a suitable cover over Chipper/Shredder.

LONG TERM STORAGE (LONGER THAN 90 DAYS)

NOTE

Follow all procedures above plus the following steps:

Do not store Chipper/Shredder for a prolonged period of time (3 months or longer) without performing protective storage maintenance, which includes the following procedures:

- Changing engine oil.
 - Lubricating combustion chamber.
 - Draining and cleaning fuel tank.
1. Change engine oil. Refer to engine manufacturer's manual.
 2. Remove spark plug and pour 1/3 oz. (10 ml.) of fresh engine oil into cylinder.
 3. Place clean rag over spark plug hole.
 4. Pull recoil starter handle twice to distribute oil.
 5. Install spark plug leaving cable detached.
 6. Close engine valves by pulling recoil starter handle until compression is felt, then pull handle 3 - 4 cm. (1 - 2 in.) further.

BATTERY

IMPORTANT

Discharged batteries may freeze and burst.

Battery Storage. All wet batteries discharge slowly when stored. Batteries discharge faster when warm than when cold. For example, at 100°F (37.8 C), a normal self-discharge of 0.0025 specific gravity per day could be expected. AT 50°F (10C), a discharge of 0.0003 specific gravity would be normal. Refer to Self-Discharge Rate chart.

Before storage, clean the battery case with a baking soda solution and wipe the case dry. When storing a battery, charge fully (no change in specific gravity after three readings taken one hour apart) and then store in as cool and dry a place as possible.

Freezing Temperature Chart

Specific Gravity (Corrected to 80°F)	Freezing Temperature
1.270	-84° F
1.250	-62° F
1.200	-16° F
1.150	+05° F
1.100	+19° F

Fully charge a stored battery before putting it into service.

Self-Discharge Rate Chart

Temperature	Approximate Allowable Self Discharge Per Day For First Ten Days (Specific Gravity)
100° F (37.8° C)	0.0025 points
80° F (26.7° C)	0.0010 points
50° F (10.0° C)	0.0003 points

REMOVING SHREDDER/CHIPPER FROM STORAGE

1. Check engine oil level.
2. Remove spark plug. Cover spark plug hole with clean rag.
3. Pull recoil starter handle several full strokes to remove oil from cylinder.
4. Check spark plug gap; install plug. Connect spark plug cable.
5. Check that guards and shields are fastened in place.
6. Fill fuel tank with correct gasoline.
7. Start and run the engine for 5 minutes before chipping or shredding.

SPECIFICATIONS AND APPLICATIONS

Models SH-3000, SH-5000, SH-8000/8000E, SH-8000 I.C., SH-8000R

CHIPPER/ SHREDDER	Model SH-3000	Model SH-5000	Model SH-8000/ SH-8000E	Model SH-8000 I.C.	Model SH-8000R
Weight	145 lbs.	187 lbs.	206 lbs.	208 lbs.	211 lbs.
Overall Size	30" x 22" x 39.5"	40" x 22" x 39.5"	44" x 22" x 39.5"	44" x 22" x 39.5"	44" x 22" x 39.5"
Hopper Size	26" x 22"	32" x 22"	35" x 22"	35" x 22"	35" x 22"
Shredder	16 free swinging self sharpening flails	16 free swinging self sharpening flails	24 free swinging self sharpening flails	24 free swinging self sharpening flails	24 free swinging self sharpening flails
Shredder Capacity	3/4" dia X 24" long	3/4" dia X 24" long	1-1/2" dia X 24" long	1-1/2" dia X 24" long	1-1/2" dia X 24" long
Chipper Capacity	2" dia	3" dia	3" dia	3" dia	3" dia
Chipper	2 blades	2 blades	2 blades	2 blades	2 blades Tool Steel
Discharge	side	side	side	side	side
Discharge Grates	3/8", 3/4" 1-1/2" (std.) Wet Debris	3/8", 3/4" 1-1/2" (std.) Wet Debris	3/8", 3/4" 1-1/2" (std.) Wet Debris	3/8", 3/4" 1-1/2" (std.) Wet Debris	3/8", 3/4" 1-1/2" (std.) Wet Debris
Clutch	over center	over center	over center	over center	over center
Drive Belt	1-5L-27"	1-5L-27"	1-5L-29"	1-5L-29"	2-4L-29" Matched Set
Tire Size	2.5 x 8	3.5 x 10.5	3.5 x 10.5	3.5 x 10.5	3.5 x 10.5
ENGINE					
Type	3 HP Briggs and Stratton	5 HP Briggs and Stratton	8 HP Briggs and Stratton	8 HP Briggs and Stratton Industrial Commercial	8 HP Honda
Electric Start	---	---	Optional as 8000E (adds 8 lbs)	---	---
Battery Type	---	---	Garden Tractor Group U1 (235 Cold Cranking Amp.)	---	---
ACCESSORIES					
Tamper	standard	standard	standard	standard	standard
Eye Goggles	standard	standard	standard	standard	standard
Tow Hitch	n/a	optional	optional	optional	optional

Free Manuals Download Website

<http://myh66.com>

<http://usermanuals.us>

<http://www.somanuals.com>

<http://www.4manuals.cc>

<http://www.manual-lib.com>

<http://www.404manual.com>

<http://www.luxmanual.com>

<http://aubethermostatmanual.com>

Golf course search by state

<http://golfingnear.com>

Email search by domain

<http://emailbydomain.com>

Auto manuals search

<http://auto.somanuals.com>

TV manuals search

<http://tv.somanuals.com>