

-
- Specifications and images in this catalogue may be subject to revision without prior notice.
 - Product colours may differ from those published.
 - The feeling of being present at the original recording can only be achieved so long as the music software reflects the recorded conditions; including microphone settings, mixing, editing and mastering.
-

FOR FURTHER INFORMATION (UK & EU)

**FUJITSU TEN (EUROPE) GMBH
UK OFFICE**

LOE House, 159 Broadhurst Gardens, London NW6 3AU, UK
Tel: +44 (0)20 7328 4499 Fax: +44 (0)20 7624 6384
E-mail: info@eclipse-td.co.uk

©2013 all rights reserved

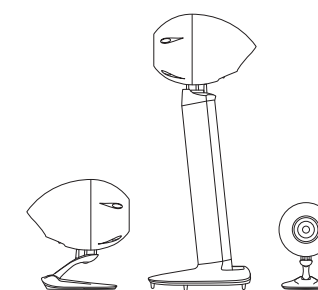

Home Audio Systems
ECLIPSE TD SERIES
TD510MK2 / TD510ZMK2 / TD508MK3

Significant recognition from serious professionals



Jim Anderson
Recording Engineer

"My experience is that I'm not aware that I'm listening to speakers, only music, and that's the highest compliment that I can give any speaker."

Multiple Grammy Award winning recording engineer and producer for his works including 'Best Surround Sound Album 2013' for Patricia Barber's 'Modern Cool', ex-chairman of Audio Engineering Society (2008-09)



Akira Fukada
Recording Engineer

"The clarity and resonance of music has been captured by Eclipse TD speakers. Only they convey true music."

Formerly chief engineer of Sony Music Entertainment and NHK (Japan Broadcasting Corporation), a surround sound recording specialist (who was responsible for developing the surround recording technique known as 'Fukada Tree' in 1997), an AES fellow and member of the Institute of Professional Sound

Just for the pure performance

The most accurate definition of good sound.

Some say a particular speaker has the best characteristics for jazz, and another the best for Mozart.

We say, this makes no sense at all.

The best speakers are those that most accurately reproduce the recording, whether it be jazz, baroque or atmospheric soundscape.

Our goal with the new ECLIPSE TD 5 series is this: greater accuracy, a closer experience of an artist's craft and emotions and a more intense appreciation of the recording engineer's skills.

In fact, our ideal is to reproduce every element that makes music great, without the speaker adding any sound of its own.

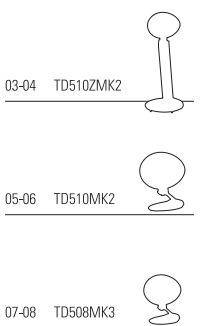

The ultimate expression of the 5 series

TD510ZMK2

10cm diameter full-range speaker system



What Hi-Fi?: 5 Star, Speaker £1500 and above Category, August 2012
 Hi-Fi Choice: 5 Star, January 2013
 Hi-Fi: Grand Prix, Speaker Category, Grand Prix 2012
 On-gen Publishing: Silver Prize, Audio Excellence Award 2013

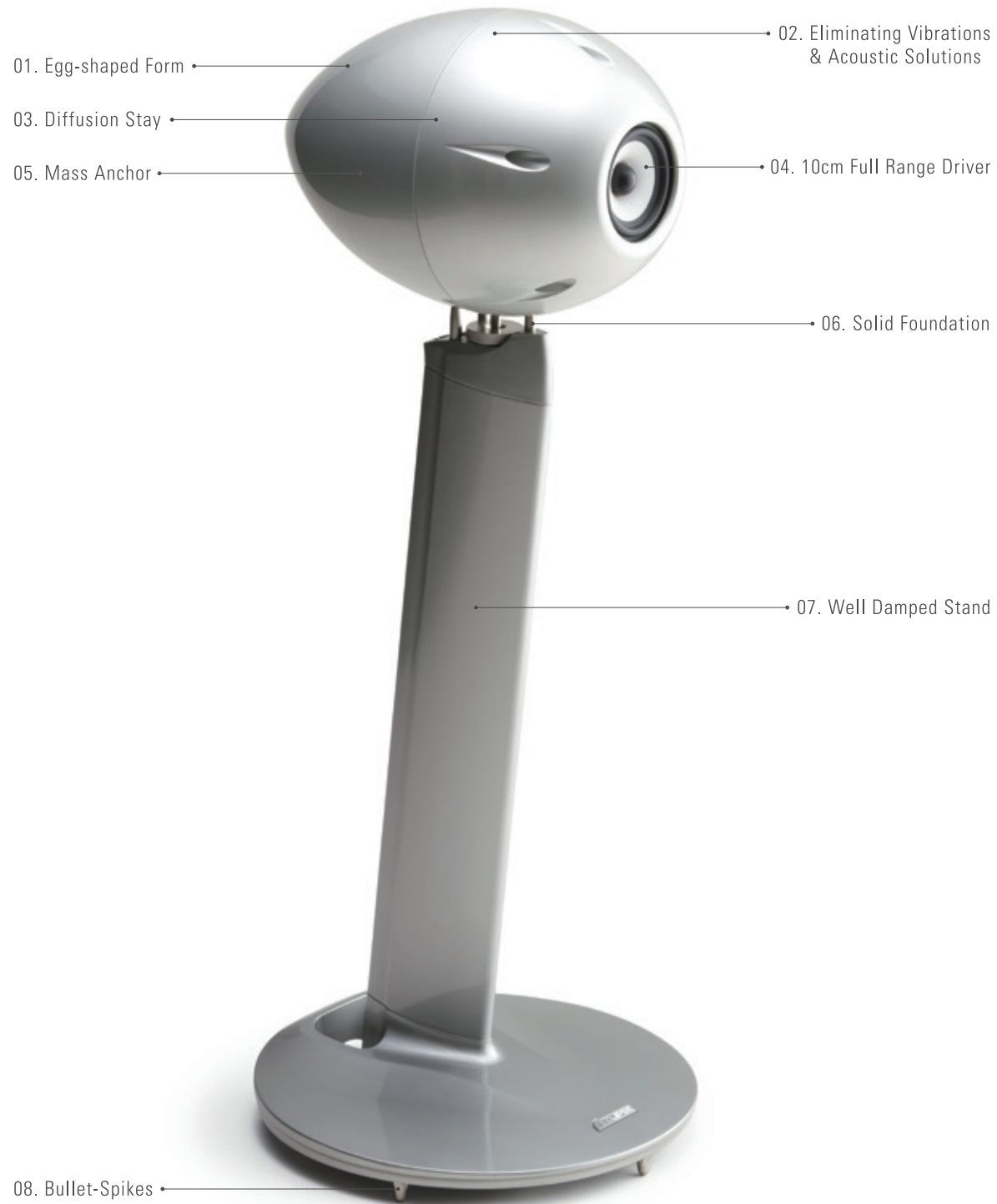

Since we developed the original 512 with our revolutionary Time Domain theory, we have been hard at work refining the series to bring you as close to perfection as possible. TD510ZMK2 is a prime example of this continuous development. It's the first 5 series model to feature an integrated stand and we have incorporated many of the key design elements of our flagship, studio professional TD712zMK2. This includes precise angle adjustment, superior clarity and tight bass response similar to that offered by TD712zMK2.



01. Egg-shaped Form

In the ECLIPSE TD series, the internal standing and diffraction waves generated at the front baffle edges are largely eliminated by adopting a rigid, yet tactile egg-shaped form, in which no two radial surfaces are in the same plane. With TD510ZMK2, the wider frequency response has been dramatically improved by increasing the internal volume of the cabinet by approximately 14% from TD510, which also helps to reduce the back pressure on the driver for better impulse response.



02. Eliminating Vibrations & Acoustic Solutions

In order for the ECLIPSE TD floating enclosure to be effective, it is necessary to address the apparent conundrum between achieving an air-tight bond, whereby the drive-unit is sealed to the enclosure, whilst eliminating the transmission of unwanted vibrations from the drive-unit. This requires a permanent bond combined with a flexible coupling.



03. Diffusion Stay

The drive-unit can be driven at extremely high speed, but because the unit is connected to the enclosure there may be some transmission of vibration from the speaker cone. The potential exists for the original sound to be corrupted by the colouration induced by the speaker enclosure. In ECLIPSE TD products these issues are addressed by a sophisticated 'diffusion stay' which in the case of TD510ZMK2 is a five-armed cast unit. Purity of sound is further enhanced by mounting the drive unit in a floating mechanism, so that no residual vibration can be transferred from the unit itself to the enclosure.



04. 10cm Full Range Driver

Because the cone needs to be extremely light, offering greater elasticity whilst still possessing a high radial rigidity, fibreglass has been chosen as the ideal material for the drive-unit. It is then connected to the enclosure by a highly flexible, butyl rubber surround incorporating a re-designed damping system. This allows precise, lateral piston movement. The magnetic flux density is approximately 4.5% percent greater than in the TD510, providing a more powerful motor system.



05. Mass Anchor

A high mass, conical anchor weight has been placed at the back of the drive-unit magnet. This structure acts as a mass sink which 'grounds' the drive-unit, ensuring that the only air movement generated by the cone is that of recreating the original musical performance.



06. Solid Foundation

TD510ZMK2 and its stand is an 'all-point' contact design, achieved by using three steel legs mounted in the top of the column in combination with a specially machined, locking ring. This design eliminates undesirable vibrations, ensures tighter lower frequency performance and allows for angle adjustments, which is an unusual option for high-end speakers. Adjustment of -10 to 15 degrees of the head angle offers a wide range of flexibility in the installation to suit the individual listening environment.



07. Well Damped Stand

The forward slanting, streamlined form of the stand prevents the disturbance of the air flow. Constructed from a combination of extruded and die-cast aluminium, it offers both rigidity and extensive internal damping eliminating any residual vibrations. The stand is filled with high-density, irregular sized kiln dried sand. It is the combination of these elements in the structure that allows precise reproduction of low frequency waveforms. Functional beauty was born from seeking high-performance.



08. Bullet-Spikes

The commitment to reproducing 'accurate sound' extends to include all elements. The TD510ZMK2 die-cast aluminium base incorporates five 20mm bullet shaped spikes. This detail, allied to the all-point-contact stand, ensures any residual vibrations from the movement of the drive-unit are isolated from the floor.

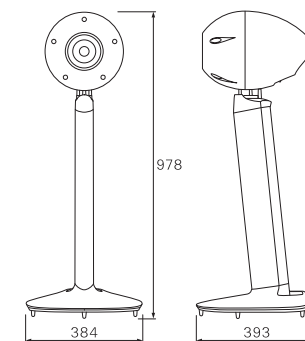

Model	TD510ZMK2 sv/BK/WH
	10cm Diameter Full-Range Speaker System
Colour Available	sv BK WH
Speaker Unit	10cm Diameter Full-Range, Fibreglass
Frequency Response	42Hz-22kHz (-10dB)
Efficiency/Sensitivity	84dB/W-m
Input Resistance (Rating/Max)	25W/50W
Impedance	6Ω
Angle Adjustment	-10°~15°
Maximum Dimensions (mm)	W384 × H978 × D393
Weight (per Speaker)	Approx. 19.5kg
Accessories	Grille × 1, Plug × 5

Unparalleled performance

TD510MK2

10cm diameter full-range speaker system



HiVi: 3rd Prize, Speaker ¥100K-¥200K Category, Winter Best Buy 2012
On-gen Publishing: Silver Prize, Audio Excellence Award 2013



01. Egg-shaped form

02. Eliminating Vibrations & Acoustic Solutions

03. Diffusion Stay

04. 10cm Full Range Driver

05. Mass Anchor

06. Solid Foundation

07. Flexible Mount

The mark two TD510 has been launched in our 10th anniversary year to exemplify 10 years of continuous technical improvements. It takes accurate sound reproduction to a whole new level, along with a new flexible adjustment, allowing to you to enjoy maximum sound fidelity mounted from the ceiling or your ideal setting for perfect sound.



01. Egg-shaped form

In the ECLIPSE TD series, the internal standing and diffraction waves generated at the front baffle edges are largely eliminated by adopting a rigid, yet tactile egg-shaped form in which no two radial surfaces are in the same plane. With TD510MK2, the wider frequency response has been dramatically improved by increasing the internal volume of the cabinet by approximately 14% from TD510, which also helps to reduce the back pressure on the driver for better impulse response.



02. Eliminating Vibrations & Acoustic Solutions

In order for the ECLIPSE TD floating enclosure to be effective, it is necessary to address the apparent conundrum between achieving an air-tight bond, whereby the drive-unit is sealed to the enclosure, whilst eliminating the transmission of unwanted vibrations from the drive-unit. This requires a permanent bond combined with a flexible coupling.



03. Diffusion Stay

The drive-unit can be driven at extremely high speed, but because the unit is connected to the enclosure there may be some transmission of vibration from the speaker cone. The potential exists for the original sound to be corrupted by the colouration induced by the speaker enclosure. In ECLIPSE TD products these issues are addressed by a sophisticated 'diffusion stay' which in the case of TD510MK2 is a five-armed cast unit. Purity of sound is further enhanced by mounting the drive unit in a floating mechanism, so that no residual vibration can be transferred from the unit itself to the enclosure.



04. 10cm Full Range Driver

Because the cone needs to be extremely light, offering greater elasticity whilst still possessing a high radial rigidity, fibreglass has been chosen as the ideal material for the drive-unit. It is then connected to the enclosure by a highly flexible, butyl rubber surround incorporating a re-designed damping system. This allows precise, lateral piston movement. The magnetic flux density is approximately 4.5% percent greater than in the TD510, providing a more powerful motor system.



05. Mass Anchor

A high mass, conical anchor weight has been placed at the back of the drive-unit magnet. This structure acts as a mass sink which 'grounds' the drive-unit, ensuring that the only air movement generated by the cone is that of recreating the original musical performance.



06. Solid Foundation

The TD510MK2 pedestal stand is an 'all-point' contact design, achieved by using three steel legs mounted in the top of the stand arm in combination with a specially machined, locking bolt. This design eliminates undesirable vibrations, ensures tighter lower frequency performance and allows for angle adjustments, which is an unusual option for high-end speakers. Adjustment of -10 to 15 degrees of the head angle offers a wide range of flexibility in the installation to suit the individual listening environment.



07. Mounting Options - Ceiling

TD510MK2 can be ceiling mounted by adding the dedicated CB1 bracket (sold separately). By changing the speaker arm setting, it will allow step-less adjustment of the speaker angle in the range of -75 to 10 degrees when fixed to the ceiling. The stand arm of TD510MK2 will accept speaker cables of less than 7mm diameter for smart installation.

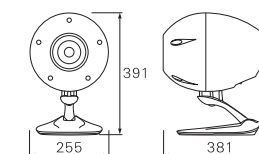

Model	TD510MK2 SV/BK/WH
	10cm Diameter Full-Range Speaker System
Colour Available	SV BK WH
Speaker Unit	10cm Diameter Full-Range, Fibreglass
Frequency Response	42Hz-22kHz (-10dB)
Efficiency/Sensitivity	84dB/W-m
Input Resistance (Rating/Max)	25W/50W
Impedance	6Ω
Angle Adjustment	On Pedestal: -10°~30° On Ceiling: 10°~-75°
Maximum Dimensions (mm)	W255 × H391 × D381
Weight (per Speaker)	Approx. 9.5kg
Accessories	Grille × 1, Plug × 5

The new core model

TD508MK3

8cm diameter full-range speaker system



What Hi-Fi?: 5 Star, Speaker from £500-£1500 Category, June 2013
 Hi-Fi: 3rd Prize, Speaker ¥100K Category, Winter Best Buy 2012
 On-gen Publishing: Gold Prize, Speaker ¥100K Category, Visual Grand Prix 2013
 On-gen Publishing: Gold Prize, Speaker ¥100K or less Category, Home Theatre Grand Prix 2013



TD508MK3 features our newly developed 8cm fibreglass drive unit to ensure an incredible level of performance way beyond the expectations of a compact monitor speaker. Our Time Domain technology ensures you are given the sense of being at the heart of a live performance, listening to the artist breathing and the unique sounds of their individual musical instruments. A new range of adjustment and flexibility offering settings for both ceiling and wall mounting makes TD508MK3 the perfect option for discerning Hi-Fi and home theatre aficionados, or as an ideal sound installation for high value commercial venues. As an additional benefit, TD508MK3 is also a pleasure to look at.



01. Egg-shaped form

In the ECLIPSE TD series, the internal standing and diffraction waves generated at the front baffle edges are largely eliminated by adopting a rigid, yet tactile egg-shaped form in which no two radial surfaces are in the same plane. With TD508MK3, the wider frequency response has been dramatically improved by increasing the internal volume of the cabinet by approximately 37% from TD508II, which also helps to reduce the back pressure on the driver for better impulse response.



02. Eliminating Vibrations & Acoustic Solutions

In order for the ECLIPSE TD floating enclosure to be effective, it is necessary to address the apparent conundrum between achieving an air-tight bond, whereby the drive-unit is sealed to the enclosure, whilst eliminating the transmission of unwanted vibrations from the drive-unit. This requires a permanent bond combined with a flexible coupling.



03. Diffusion Stay

The drive-unit can be driven at extremely high speed, but because the unit is connected to the enclosure there may be some transmission of vibration from the speaker cone. The potential exists for the original sound to be corrupted by the colouration induced by the speaker enclosure. In ECLIPSE TD products these issues are addressed by a sophisticated 'diffusion stay' which in the case of TD508MK3 is a four-armed cast unit. Purity of sound is further enhanced by mounting the drive unit in a floating mechanism, so that no residual vibration can be transferred from the unit itself to the enclosure.



04. 8cm Full Range Driver

Because the cone needs to be extremely light, offering greater elasticity whilst still possessing a high radial rigidity, fibreglass has been chosen as the ideal material for the drive-unit. It is then connected to the enclosure by a highly flexible, butyl rubber surround incorporating a re-designed damping system. This allows precise, lateral piston movement. The magnetic flux density is approximately 17% percent greater than in TD508II, providing a more powerful motor system.



05. Mass Anchor

A high mass, conical anchor weight has been placed at the back of the drive-unit magnet. This structure acts as a mass sink which 'grounds' the drive-unit, ensuring that the only air movement generated by the cone is that of recreating the original musical performance.



06. Solid Foundation

The TD508MK3 pedestal stand is an 'all-point' contact design, achieved by using three steel legs mounted in the top of the stand arm in combination with a specially machined, locking bolt. This design eliminates undesirable vibrations, ensures tighter lower frequency performance and allows for angle adjustments, which is an unusual option for high-end speakers. Adjustment of -10 to 30 degrees of the head angle offers a wide range of flexibility in the installation to suit the individual listening environment.

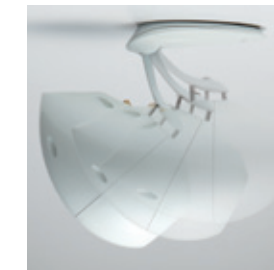

07. Flexible Mount - Ceiling

TD508MK3 can be mounted on the ceiling with CB1 bracket (sold separately). By changing the speaker arm setting, it will allow a step-less speaker angle adjustment in the range of -75 to 10 degrees against the ceiling.



08. Flexible Mount - Wall

TD508MK3 can be mounted on the wall with CB1 bracket (sold separately). By changing the speaker arm setting, it will allow a step-less speaker angle adjustment in the range of 20 to 75 degrees against the wall.

The stand arm of TD508MK3 will accept speaker cables of less than 7mm diameter for smart installation.

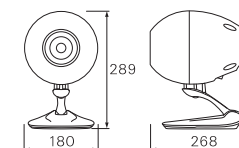

Model	TD508MK3 sv/BK/WH
	8cm Diameter Full-Range Speaker System
Colour Available	SV BK WH
Speaker Unit	8cm Diameter Full-Range, Fibreglass
Frequency Response	52Hz-27kHz (-10dB)
Efficiency/Sensitivity	82dB/W-m
Input Resistance (Rating/Max)	15W/30W
Impedance	8Ω
Angle Adjustment	On Pedestal: -10°~30° On Ceiling: 10°~75° On Wall: 20°~75°
Maximum Dimensions (mm)	W180 × H289 × D268
Weight (per Speaker)	Approx. 3.5kg
Accessories	Grille x 1

Dedicated floor stand for TD508MK3

508DMK3



Angle Adjustment

Angle adjustment of -10 to 15 degrees of the head offers a wide range of flexibility in the installation to suit the individual listening environment.



Column

The coupling with the speaker on 508DMK3 is an 'all-point' contact design suppressing the transmission of unwanted vibration. Extruded aluminium was selected for its rigidity and suppression of resonance.

Model	508DMK3 sv/wh
	Dedicated Floor Stand for TD508MK3
Colour Available	<input type="checkbox"/> SV <input type="checkbox"/> WH
Maximum Dimensions (mm)	W300 x H773 x D280
Weight (per Stand)	Approx. 5.4kg
Accessories	—

Mounting bracket for TD510MK2 and TD508MK3

CB1

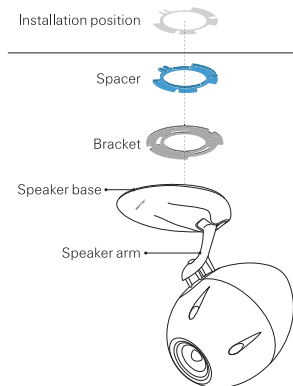
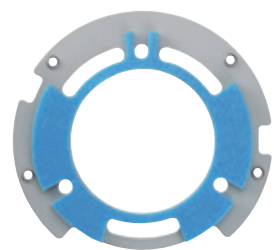

Using the CB1 provides stability and versatility offering 10 degrees of lateral adjustment prior to fixing.



Attach to the stand base

Model	CB1
	Mounting Bracket for TD510MK2 and TD508MK3
Maximum Dimensions (mm)	Spacer: Diameter 110 x Thickness 5 Bracket: Diameter 131 x Thickness 1.6
Weight (per Bracket)	Approx. 120g
Accessories	Safety Cable x 1



For further information including:

Detailed product information

Interviews with top international artists and engineers who are ECLIPSE TD users

Stockists and events

Free Manuals Download Website

<http://myh66.com>

<http://usermanuals.us>

<http://www.somanuals.com>

<http://www.4manuals.cc>

<http://www.manual-lib.com>

<http://www.404manual.com>

<http://www.luxmanual.com>

<http://aubethermostatmanual.com>

Golf course search by state

<http://golfingnear.com>

Email search by domain

<http://emailbydomain.com>

Auto manuals search

<http://auto.somanuals.com>

TV manuals search

<http://tv.somanuals.com>